

## Flat suction cup (round)

SPF 40 ED-65 G1/4-AG

Part no...:10.01.01.13246

<https://www.schmalz.com/10.01.01.13246>

Home > Vacuum Technology for Automation > Vacuum Components > Vacuum Suction Cups > Suction Cups for the Packaging Industry > Flat Suction Cups SPF > SPF 40 ED-65 G1/4-AG

### Flat suction cup (round) for dynamic handling of cardboard and rigid packaging



Size: 40

Suction cup material: Elastodur

Material hardness [Shore A]: 65 Shore A

Thread G1: G1/4"-M

### Design Data

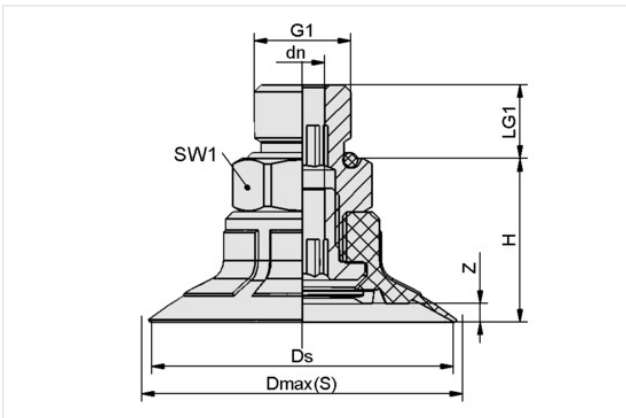

Attribute	Value
dn	6.10 mm
Dmax(S)	43.70 mm
Ds	41.40 mm
G1	G1/4"-M
H	22.20 mm
LG1	10 mm
SW1	17 mm
Z (Stroke)	2.50 mm

Note: Acceptable dimensional tolerances for elastomer parts concerning to DIN ISO 3302-1 M3

### Technical Data

Attribute	Value
Suction force (-600mbar)	49.50 N
Pull-off force	62.50 N
Lateral force	25 N
Volume	5.09 cm <sup>3</sup>
Curve radius (min) (convex)	70 mm
Hose diameter (empf.) d	6 mm
Size	40

### Contact Schmalz

Schmalz Inc. | 5850 Oak Forest Drive, Raleigh, NC 27616, United States | +1 (919) 713-0880 | [schmalz.us@schmalz.com](mailto:schmalz.us@schmalz.com)

## Flat suction cup (round)

SPF 40 ED-65 G1/4-AG

Part no...:10.01.01.13246

<https://www.schmalz.com/10.01.01.13246>

Number of folds	0
Suction cup material	Elastodur
Material hardness [Shore A]	65 Shore A
Weight	18.80 g
Product family	SPF

Note: Suction force: The specified suction forces are theoretical values at a vacuum of -0.6 bar and with a dry, smooth and flat workpiece surface - they do not include a safety factor Hose diameter: The recommended hose diameter refers to a hose length of approx. 2 m

### Accessories



#### SIEB 17.5x0.8 MS-A2 280 0.28/0.16

Part no...:10.07.01.00308

External diameter D: 17.5 mm

Length L: 0.8 mm

Material: Brass / Stainless steel

Filter pore size: 280 µm



#### SU 40

Part no...:10.01.01.12856

Size: 40

Clamping range: 35.0 ... 45.0 mm

Temperature resistance: 80 °C

## Flat suction cup (round)

SPF 40 ED-65 G1/4-AG

Part no...:10.01.01.13246

<https://www.schmalz.com/10.01.01.13246>



### SC-SW 60 6

Part no...:10.05.04.00096

Spanner size SW1: 6 mm



### SC-SW 80 6

Part no...:10.05.04.00097

Spanner size SW1: 6 mm



### SC-SW 100 6

Part no...:10.05.04.00098

Spanner size SW1: 6 mm

## Flat suction cup (round)

SPF 40 ED-65 G1/4-AG

Part no...:10.01.01.13246

<https://www.schmalz.com/10.01.01.13246>



### SC-SW 120 6

Part no...:10.05.04.00099

Spanner size SW1: 6 mm



### SC-SW 200 6

Part no...:10.05.04.00100

Spanner size SW1: 6 mm



### SC-SW 240 6

Part no...:10.05.04.00101

Spanner size SW1: 6 mm

## Spare parts

### Contact Schmalz

Schmalz Inc. | 5850 Oak Forest Drive, Raleigh, NC 27616, United States | +1 (919) 713-0880 | [schmalz.us@schmalz.com](mailto:schmalz.us@schmalz.com)

## Flat suction cup (round)

SPF 40 ED-65 G1/4-AG

Part no...:10.01.01.13246

<https://www.schmalz.com/10.01.01.13246>



### SC 050 G1/4-AG MOD

Part no...:10.01.06.02487

Connection geometry: 050

Connection: G1/4"-M

Length L1: 26.5 mm

Fitting length: 7.2 mm

Nominal diameter dn: 6.1 mm



### SPF 40 ED-65 SC050

Part no...:10.01.01.12373

Size: 40

Suction cup material: Elastodur

Material hardness [Shore A]: 65 Shore A

Height H: 15 mm