

10-way In-System Programming (ISP) Cable (0.1" IDC connectors)

Equinox Code: **CAB-ISP10W200**

Digikey Code: **483-1030-ND**

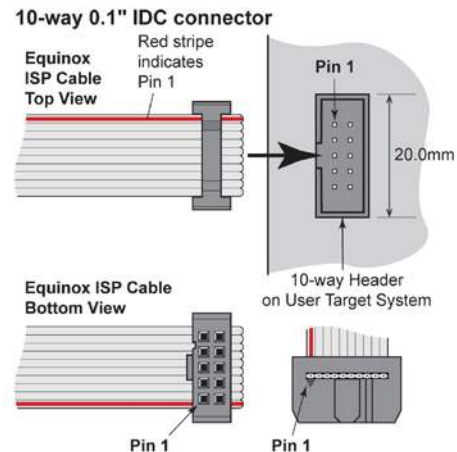
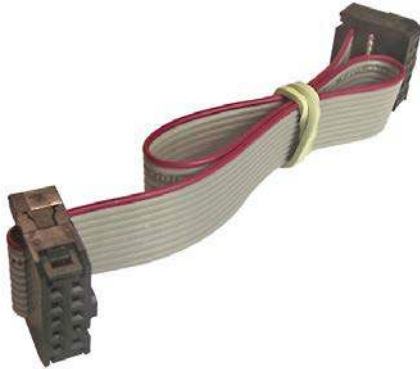

The **CAB-ISP10W200** is a **10-way** In-System Programming (ISP) ribbon cable designed to connect from any ISP programmer which features a 10-way IDC connector to a 10-way 0.1" pitch IDC connector on a suitable Target System. The cable features 200mm of flat ribbon cable with a 10-way IDC 0.1" pitch female connector on each end. The IDC connectors are fitted with 'cable grips' and are bump polarised to prevent the connector being plugged in the wrong way around.

The **CAB-ISP10W200** cable is suitable for use with any Equinox ISP programmer and also with any programmer or 'Starter Kit' which features the 10-way 0.1" pitch IDC connector. eg. Atmel STK500, STK501 etc.





Specification:

- Cable length (connector to connector): 200mm
- Cable type: 10-way flat ribbon cable (red stripe denotes pin 1)
- Each end of the cable is terminated with a 10-way 0.1" pitch IDC female connector
- Connectors are fitted with 'cable grips' for added resilience.
- Connectors are bump-polarised to stop the connector being plugged in the wrong way around

This cable is compatible with the following equipment:

- Any Equinox ISP programmer with a 10-way 0.1" pitch IDC connector eg. Equinox EPSILON5, EPSILON5-MK4, FS2000A, FS2003, FS2009, FS2009USB, PPM3-MK2, PPM4-MK4
- Any ISP Starter Kit or Development Board which features a 10-way IDC connector eg. Atmel STK500, STK501, STK502, STK505 etc
- Any other programmer or Target PCB which features a 0.1" pitch 10-way IDC male connector.

ISP Ribbon Cable - family overview

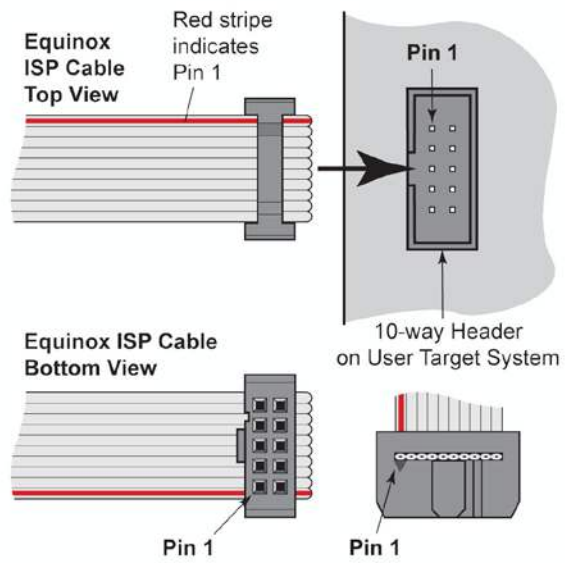
<p>6-way 0.1" pitch ISP ribbon cable (200mm)</p>	<p>20-way 0.1" pitch ISP ribbon cable for ARM microcontrollers (200mm)</p>
<p>Digi-key - 483-1029-ND Equinox - CAB-ISP6W200</p> 	<p>Digi-key - 483-1032-ND Equinox - CAB-ARM-20W</p> 
<p>10-way 0.1" pitch ISP ribbon cable (200mm)</p>	<p>10-way 0.05" pitch ISP ribbon cable for ARM microcontrollers - (150mm)</p>
<p>Digi-key - 483-1030-ND Equinox - CAB-ISP10W200</p> 	<p>Digi-key - 483-1033-ND Equinox - CAB-ARM-10W-150</p> 
<p>16-way 0.1" pitch ISP ribbon cable (200mm)</p>	<p>Typical layout of an ISP cable connector (10-way)</p>
<p>Digi-key - 483-1031-ND Equinox - CAB-16W/16W-ISP-RIBBON</p> 	 <p>The diagram illustrates the typical layout of a 10-way ISP cable connector. It includes three views: <ul style="list-style-type: none"> Equinox ISP Cable Top View: Shows the ribbon cable with a red stripe indicating Pin 1. Equinox ISP Cable Bottom View: Shows the underside of the cable with Pin 1 labeled. 10-way Header on User Target System: Shows a header with Pin 1 labeled, which the cable connects to. </p>