

MC830 Series (0 to +75°C)  
MC930 Series (-55 to +125°C)

ISSUE A

### MAXIMUM RATINGS

Rating	Value	Unit
Supply Voltage —		Vdc
Operating	4.5 to 5.5	
Continuous	8.0	
Pulsed, < 1 second	12	
Output Current (Into Outputs with Outputs Low)		mA <sub>dc</sub>
Buffers, Power Gates — Continuous	100	
Pulsed, < 30 ms	300	
All other types — Continuous	30	
Pulsed, < 30 ms	90	
Input Forward Current —		mA <sub>dc</sub>
Continuous	-10	
Pulsed, < 30 ms	-30	
or		Vdc
Negative Voltage at Input —		
Continuous	-0.5	
Pulsed, < 30 ms	-1.5	
Input Reverse Current	1.0	mA <sub>dc</sub>
or		Vdc
Positive Voltage at Diode Input	5.5	
Operating Temperature Range		°C
MC930 Series	-55 to +125	
MC830 Series	0 to +75	
Storage Temperature Range		°C
Metal Can, Ceramic Package	-65 to +150	
Plastic Package	-55 to +125	
Maximum Junction Temperature		°C
MC930 Series	175	
MC830 Series	150	

MDTL integrated circuits provide an excellent balance of speed, power dissipation, and noise immunity for general purpose digital applications. The line includes many multifunction types. Additional logic power is provided by the "wired OR" capability of the basic MDTL gate.



**G SUFFIX**  
METAL PACKAGE  
CASE 603-02  
TO-100

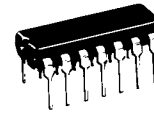

**P SUFFIX**  
PLASTIC PACKAGE  
CASE 646

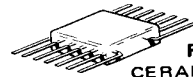

**F SUFFIX**  
CERAMIC PACKAGE  
CASE 607

**P SUFFIX**  
PLASTIC PACKAGE  
CASE 648

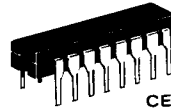

**L SUFFIX**  
CERAMIC PACKAGE  
CASE 620

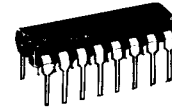

**L SUFFIX**  
CERAMIC PACKAGE  
CASE 632  
TO-116

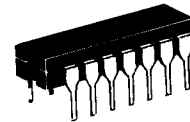

### FUNCTIONS AND CHARACTERISTICS (V<sub>CC</sub> = 5.0 Vdc, T<sub>A</sub> = 25°C)

Function	Type ① 0 to +75°C	Case	Type ① -55 to +125°C	Case	Loading Factor Each Output	Propagation Delay ns typ	Power Dissipation mW typ/pkg
Expandable Dual 4 Input NAND Gate	MC830	607,632,646	MC930	607,632	8	30	22
Expandable Dual 3 2 Input NAND Gate	MC830	603	MC930	603	8	30	22
Expandable Dual 4 Input Buffer	MC832	607,632,646	MC932	607,632	25	35	85
Expandable Dual 3 2 Input Buffer	MC832	603	MC932	603	25	35	85
Dual 4 Input Expander	MC833	607,632,646	MC933	607,632	—	—	—
Dual 4 3 Input Expander	MC833	603	MC933	603	—	—	—
Hex Inverter	MC834	607,632,646	MC934	607,632	8	30	66
Hex Inverter (without output resistors)	MC835	607,632,646	MC935	607,632	8	30	42
Hex Inverter	MC836	607,632,646	MC936	607,632	8	30	66
Hex Inverter	MC837	607,632,646	MC937	607,632	7	25	90
Decade Counter	MC838	607,632,646	MC938	607,632	8	30 MHz ③	150
Divide-by-Sixteen Counter	MC839	607,632,646	MC939	607,632	8	30 MHz ③	150
Hex Inverter (without input diodes)	MC840	607,632,646	MC940	607,632	8	30	66
Hex Inverter (without output resistors and input diodes)	MC841	607,632,646	MC941	607,632	8	30	42
Expandable Dual 4-Input Power Gate	MC844	607,632,646	MC944	607,632	27	30	65
Expandable Dual 3 2-Input Power Gate	MC844	603	MC944	603	27	30	65
Clocked Flip-Flop	MC845	603,607,632,646	MC945	603,607,632	12/10 ②	40	60
Quad 2-Input NAND Gate	MC846	607,632,646	MC946	607,632	8	30	44
Quad Inverter	MC846	603	MC946	603	8	30	44
Quad 2-Input Gate Expander	MC847	607,632,646	MC947	607,632	—	—	—
Clocked Flip-Flop	MC848	603,607,632,646	MC948	603,607,632	11/9 ②	40	70
Quad 2-Input NAND Gate (2 k pullup resistor)	MC849	607,632,646	MC949	607,632	7	25	66
Quad Inverter (2 k pullup resistor)	MC849	603	MC949	603	7	25	60
Pulse Triggered Binary Monostable Multivibrator	MC850	603,607,632,646	MC950	603,607,632	10/8 ②	15	50
Dual J-K Flip-Flop (common clock and C <sub>D</sub> , separate S <sub>D</sub> )	MC851	603,607,632,646	MC951	603,607,632	10	40	30
Dual J-K Flip-Flop (separate clock and S <sub>D</sub> , no C <sub>D</sub> )	MC852	607,632,646	MC952	607,632	12/10 ②	40	120
	MC853	607,632,646	MC953	607,632	12/10 ②	40	120

① F suffix denotes Ceramic Flat Package, G suffix denotes Metal Can, L suffix denotes Dual In-Line Ceramic Package, P suffix denotes Dual In-Line Plastic Package. (i.e., MC830G = Metal Can, MC830F = Flat Package, MC830L = Dual In-Line Ceramic Package, MC830P = Plastic Package)

② Fan-out for MC830 series type / Fan-out for MC930 series type.

③ Counting frequency.

continued

MDTL (continued)

Function	Type ① 0 to +75°C	Case	Type ① -55 to +125°C	Case	Loading Factor Each Output	Propaga- tion Delay ns typ	Power Dissipation mW typ/pkg
Dual J-K Flip-Flop (common clock and C <sub>D</sub> , separate S <sub>D</sub> , 2 k pullup resistor)	MC855	607,632,646	MC955	607,632	11/9 ②	40	140
Dual J-K Flip-Flop (separate clock and S <sub>D</sub> , no C <sub>D</sub> , 2 k pullup resistor)	MC856	607,632,646	MC956	607,632	11/9 ②	40	140
Quad 2-Input Buffer	MC857	607,632,646	MC957	607,632	25	35	170
Quad 2-Input NAND Power Gate	MC858	607,632,646	MC958	607,632	27	30	130
Expandable Dual 4-Input NAND Gate (2 k pullup resistor)	MC861	607,632,646	MC961	607,632	7	25	33
Expandable Dual 3-2 Input NAND Gate (2 k pullup resistor)	MC861	603	MC961	603	7	25	33
Triple 3-Input NAND Gate	MC862	607,632,646	MC962	607,632	8	30	33
Dual 2-Input NAND Gate plus Inverter	MC862	603	MC962	603	8	30	30
Triple 3-Input NAND Gate (2 k pullup resistor)	MC863	607,632,646	MC963	607,632	7	25	50
Dual 2-Input NAND Gate plus Inverter (2 k pullup resistor)	MC863	603	MC963	603	7	25	45
Dual 5-Input NAND Gate (6K pullup resistor)	MC1800	607,632,646	MC1900	607,632	8	30	22
Dual 5-Input NAND Gate (2 k pullup resistor)	MC1801	607,632,646	MC1901	607,632	7	25	33
Expandable 8-Input NAND Gate	MC1802	607,632,646	MC1902	607,632	8	30	11
Expandable 8-Input NAND Gate (2 k pullup resistor)	MC1803	607,632,646	MC1903	607,632	7	25	16.5
10-Input NAND Gate	MC1804	607,632,646	MC1904	607,632	8	30	11
10-Input NAND Gate (2 k pullup resistor)	MC1805	607,632,646	MC1905	607,632	7	25	16.5
Quad 2-Input AND Gate	MC1806	607,632,646	MC1906	607,632	8	35	72
Quad 2-Input AND Gate (2 k pullup resistor)	MC1807	607,632,646	MC1907	607,632	7	30	85
Quad 2-Input OR Gate	MC1808	607,632,646	MC1908	607,632	8	35	97
Quad 2-Input OR Gate (2 k pullup resistor)	MC1809	607,632,646	MC1909	607,632	7	30	115
Quad 2-Input NOR Gate	MC1810	607,632,646	MC1910	607,632	8	30	60
Quad 2-Input NOR Gate (2 k pullup resistor)	MC1811	607,632,646	MC1911	607,632	7	25	72
Quad 2-Input Exclusive OR Gate	MC1812	607,632,646	MC1912	607,632	8	40	120
Quad Latch	MC1813	620,648	-	-	7	35	220
Quad Latch	MC1814	607,632,646	MC1914	607,632	7	35	220
Parallel Gated Clocked Flip-Flop	MC1815	607,632,646	MC1915	607,632	12/10 ②	40	65
Parallel Gated Clocked Flip-Flop	MC1816	607,632,646	MC1916	607,632	11/9 ②	40	75
Quad 2-Input NAND Gate (without output resistor)	MC1818	607,632,646	MC1918	607,632	8	30	32
High Voltage Hex Inverter	MC1820	632,646	-	-	7	40	42

① F suffix denotes Ceramic Flat Package, G suffix denotes Metal Can, L suffix denotes Dual in-Line Ceramic Package, P suffix denotes Dual In-Line Plastic Package. (i.e., MC830G = Metal Can, MC830F = Flat Package, MC830L = Dual In-Line Ceramic Package, MC830P = Plastic Package)

② Fan-out for MC830 series type/Fan-out for MC930 series type.

③ Counting frequency.

\*Unless otherwise noted

Case	Gnd* Pin No.	V <sub>CC</sub> * Pin No.
603	5	10
646	7	14
607	7	14
648	8	16
620	8	16
632	7	14

## GATES

Numbers at ends of terminals represent pin numbers. Numbers in parenthesis indicate loading.

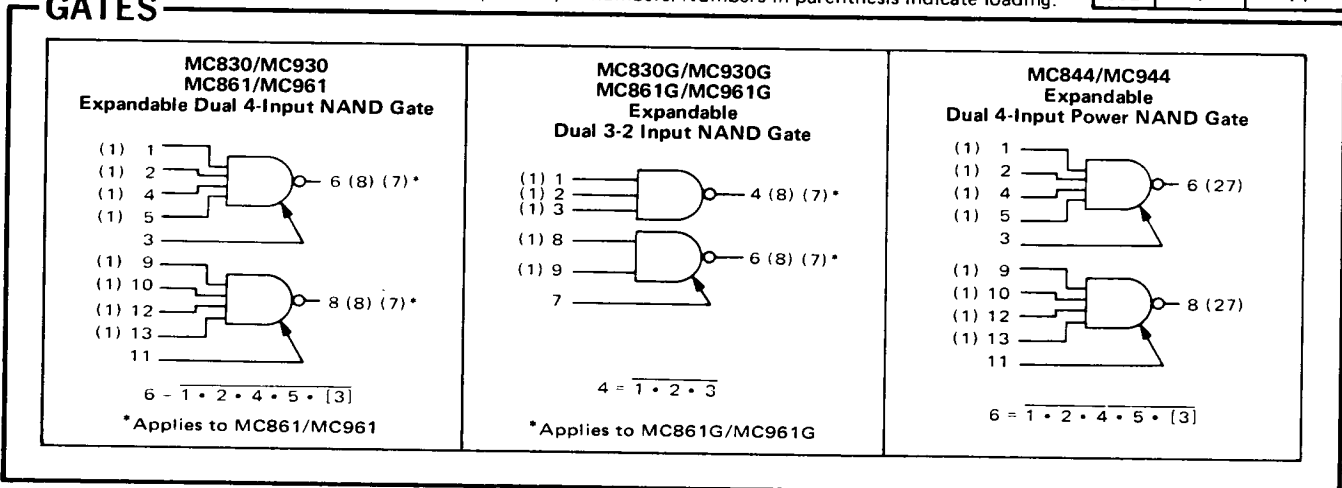

# GATES (continued)

**MC844G/MC944G**  
Expandable  
Dual 3-2 Input NAND Power Gate

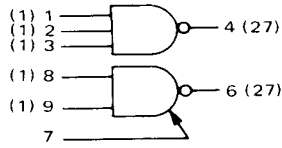

$$4 = \overline{1 \cdot 2 \cdot 3}$$

**MC846/MC946**  
**MC849/MC949**  
Quad 2-Input NAND Gate

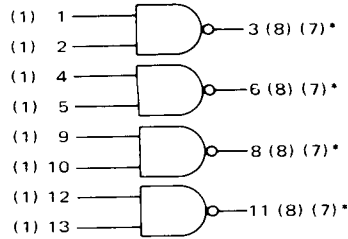

$$3 = \overline{1 \cdot 2}$$

\*Applies to MC849/MC949

**MC858/MC958**  
Quad 2-Input NAND Power Gate

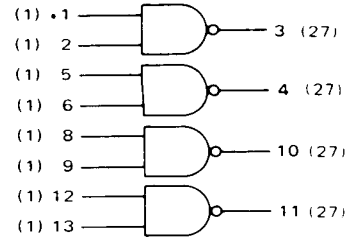

$$3 = \overline{1 \cdot 2}$$

**MC862/MC962**  
**MC863/MC963**  
Triple 3-Input NAND Gate

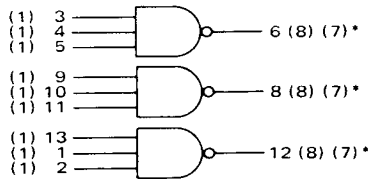

$$6 = \overline{3 \cdot 4 \cdot 5}$$

\*Applies to MC863/MC963

**MC862G/MC962G**  
**MC863G/MC963G**  
Dual 2-Input NAND Gate  
Plus Inverter

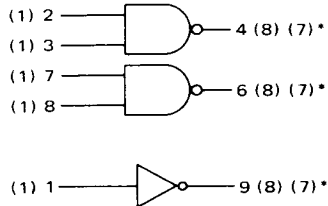

$$4 = \overline{2 \cdot 3}$$

$$6 = \overline{7 \cdot 8}$$

$$9 = \overline{1}$$

\*Applies to MC863G/MC963G

**MC1800/MC1900**  
**MC1801/MC1901**  
Dual 5-Input NAND Gate

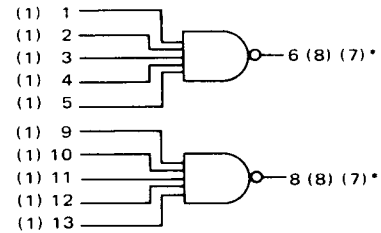

$$6 = \overline{1 \cdot 2 \cdot 3 \cdot 4 \cdot 5}$$

\*Applies to MC1801/MC1901

**MC1802/MC1902**  
**MC1803/MC1903**  
Expandable 8-Input NAND Gate

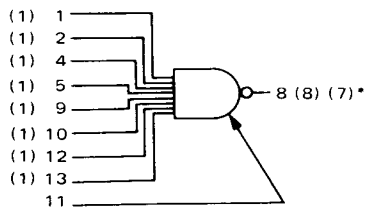

$$8 = \overline{1 \cdot 2 \cdot 4 \cdot 5 \cdot 9 \cdot 10 \cdot 12 \cdot 13 \cdot [11]}$$

\*Applies to MC1803/MC1903

**MC1804/MC1904**  
**MC1805/MC1905**  
10-Input NAND Gate

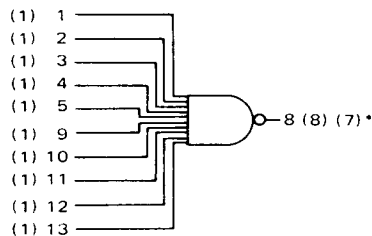

$$8 = \overline{1 \cdot 2 \cdot 3 \cdot 4 \cdot 5 \cdot 9 \cdot 10 \cdot 11 \cdot 12 \cdot 13}$$

\*Applies to MC1805/MC1905

**MC1806/MC1906**  
**MC1807/MC1907**  
Quad 2-Input AND Gate

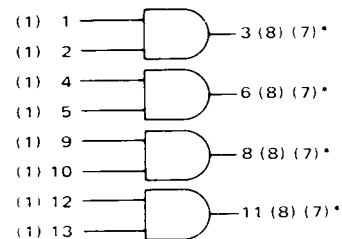

$$3 = 1 \cdot 2$$

\*Applies to MC1807/MC1907

(continued)

# GATES (continued)

**MC1808/MC1908  
MC1809/MC1909  
Quad 2-Input OR Gate**

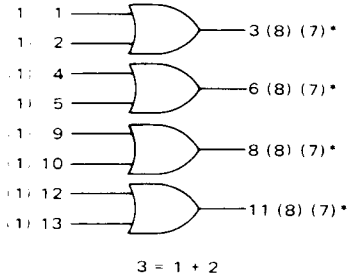

\*Applies to MC1809/MC1909

**MC1810/MC1910  
MC1811/MC1911  
Quad 2-Input NOR Gate**

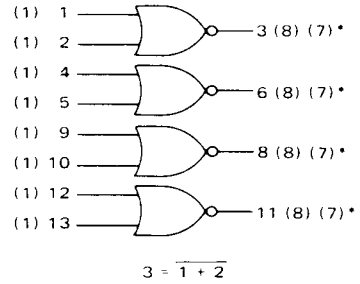

\*Applies to MC1811/MC1911

**MC1812/MC1912  
Quad 2-Input Exclusive OR Gate**

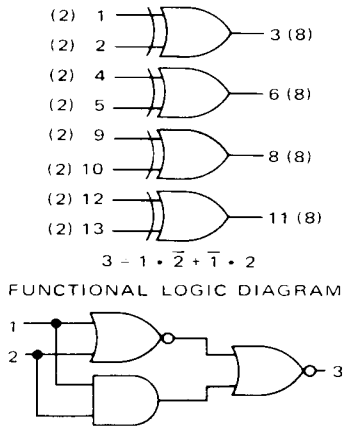

**MC1818/MC1918  
Quad 2-Input NAND Gate  
(Without Output Resistors)**

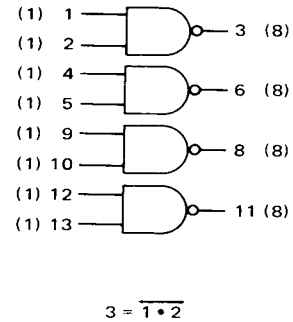

# MULTIVIBRATOR

**MC851/MC951  
Monostable Multivibrator**

F,L,P, PACKAGES

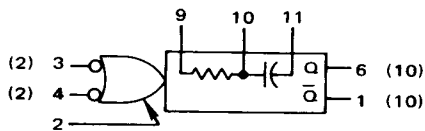

G PACKAGE  
VCC = Pin 6, Gnd = Pin 1

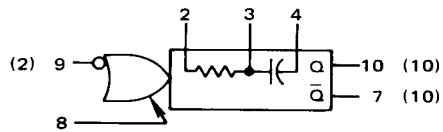

# FLIP-FLOPS

## MC845/MC945 MC848/MC948 Clocked Flip-Flop

F, L, & P PACKAGES

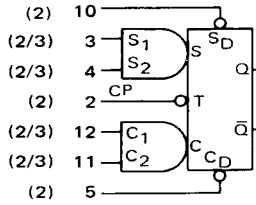

G PACKAGES

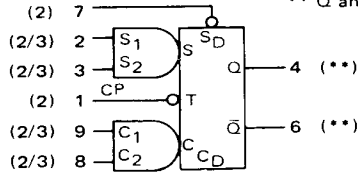

\*\* Q and  $\bar{Q}$  loading factor: 12 for MC845 types  
10 for MC945 types  
11 for MC848 types  
9 for MC948 types

SYNCHRONOUS TRUTH TABLE

$t_n$				$t_{n-1}$
$S_1$	$S_2$	$C_1$	$C_2$	$Q$
0	X	0	X	$Q_n$
0	X	X	0	$Q_n$
X	0	0	X	$Q_n$
X	0	X	0	$Q_n$
0	X	1	1	0
X	0	1	1	0
1	1	0	X	1
1	1	X	0	1
1	1	1	1	U

0 — Low State (more negative)  
1 — High State (more positive)  
X — State of the input does not affect the state of the circuit.  
U — Indeterminate State

J-K TRUTH TABLE  
(Connect  $S_2$  to  $\bar{Q}$ ,  $C_2$  to Q)

$t_n$		$t_{n-1}$
$S_1$	$C_1$	$Q$
0	0	$Q_n$
1	0	1
0	1	0
1	1	$\bar{Q}_n$

ASYNCHRONOUS TRUTH TABLE

$S_D$	$C_D$	$Q$	$\bar{Q}$
1	1	NC	NC
0	1	1	0
1	0	0	1
0	0	1	1

Asynchronous inputs, direct set ( $S_D$ ) and direct clear ( $C_D$ ), override the synchronous inputs; they are independent of all other inputs.

## MC852/MC952 MC855/MC955 Dual J-K Flip-Flop

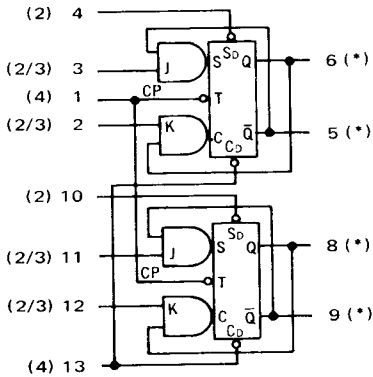

\*Q and  $\bar{Q}$  loading factor:  
12 — MC852  
10 — MC952  
11 — MC855  
9 — MC955

ASYNCHRONOUS TRUTH TABLE  
MC952/MC852 and MC955/MC855

$S_D$	$C_D$	$Q$	$\bar{Q}$
1	1	NC	NC
0	1	1	0
1	0	0	1
0	0	1	1

ASYNCHRONOUS TRUTH TABLE  
MC953/MC853 and MC956/MC856

$S_D$	$Q$	$\bar{Q}$
1	NC	NC
0	1	0

Asynchronous inputs, direct set ( $S_D$ ) and direct clear ( $C_D$ ), override the synchronous inputs; they are independent of all other inputs.

J-K TRUTH TABLE  
All Types

$t_n$		$t_{n-1}$
J	K	$Q$
0	0	$Q_n$
1	0	1
0	1	0
1	1	$\bar{Q}_n$

J & K inputs must not change while clock is high.

## MC853/MC953 MC856/MC956 Dual J-K Flip-Flop

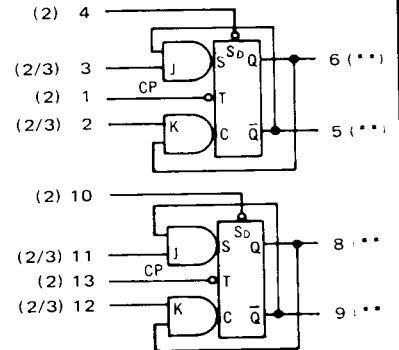

\*\*Q and  $\bar{Q}$  loading factor  
12 — MC853  
10 — MC953  
11 — MC856  
9 — MC956

continued

# MDTL LOGIC DIAGRAMS

## FLIP-FLOPS (continued)

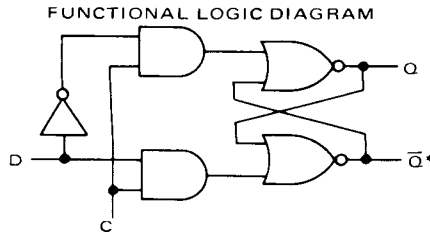
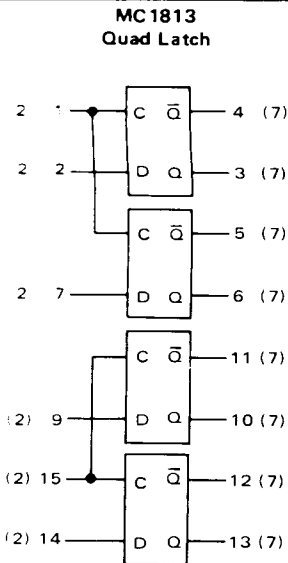

Information present at the Data Input D is transferred to the Q output when the clock is high, and the Q output will follow the state of the Data input as long as the clock remains high. Information present at the Q output will be retained as the clock goes low until such time as the clock is permitted to go high.

**TRUTH TABLE**

$t_n$	$t_{n+1}$	
	Q	$\bar{Q}^*$
1	1	0
0	0	1

\*As applicable (see loading diagram)

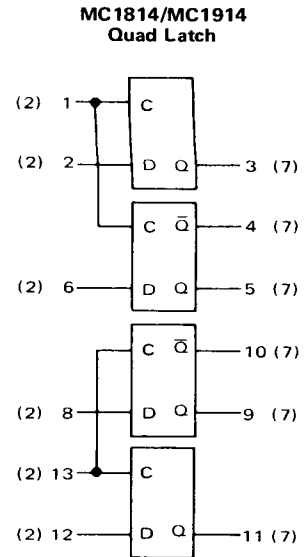

**MC1815/MC1915  
MC1816/MC1916  
Parallel Gated Clocked Flip-Flop**

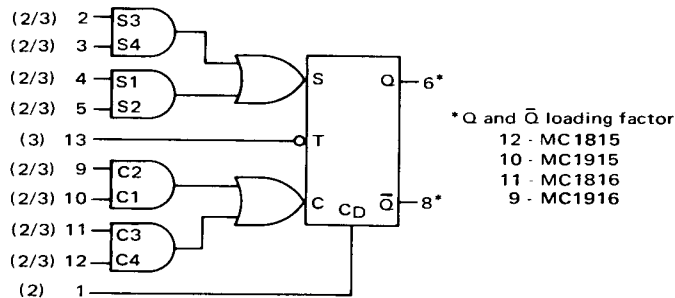

**SYNCHRONOUS TRUTH TABLE**

$C_D$	$t_n$								$t_{n+1}$
	$C_3$	$C_4$	$C_1$	$C_2$	$S_3$	$S_4$	$S_1$	$S_2$	Q
1	0	0	0	0	0	0	0	0	$Q_n$
1	1	1	0	0	0	0	0	0	0
1	0	0	1	1	0	0	0	0	0
1	1	1	1	1	0	0	0	0	0
1	0	0	0	0	1	1	0	0	1
1	1	1	0	0	1	1	0	0	0
1	0	0	1	1	1	1	0	0	U
1	1	1	0	0	0	0	1	1	1
1	0	0	0	0	0	0	1	1	U
1	1	1	1	1	0	0	1	1	U
1	0	0	0	0	1	1	1	1	U
1	1	1	0	0	1	1	1	1	U
1	0	0	1	1	1	1	1	1	U
1	1	1	1	1	1	1	1	1	U

0 - Low State (more negative)      NC - No Change  
 1 - High State (more positive)      U - Indeterminate State

**J-K TRUTH TABLE**  
(Connect S2 and S4 to  $\bar{Q}$ , C2 and C4 to Q)

$t_n$				$t_{n+1}$
S1	S3	C1	C3	Q
0	0	0	0	$Q_n$
1	1	0	0	1
0	0	1	1	0
1	1	1	1	$\bar{Q}_n$

**ASYNCHRONOUS TRUTH TABLE**

$C_D$	Q	$\bar{Q}$
1	NC	NC
0	0	1

Asynchronous input, direct clear ( $C_D$ ), overrides the synchronous inputs. Clocked operation will occur only when  $C_D$  is in the High State.

# INVERTERS

**MC834/MC934  
Hex Inverter**

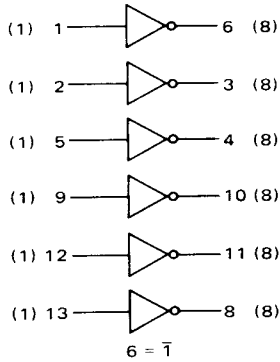

**MC835/MC935  
Hex Inverter  
(Without Output Resistors)**

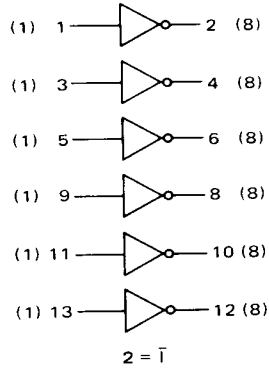

**MC836/MC936  
MC837/MC937  
Hex Inverter**

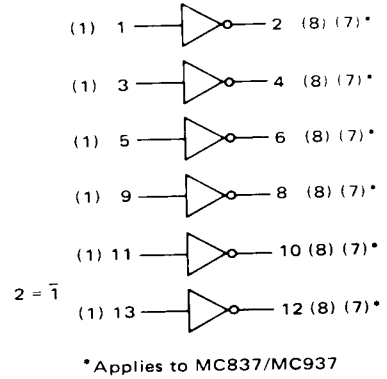

**MC840/MC940  
Hex Inverter  
(Without Input Diodes)**

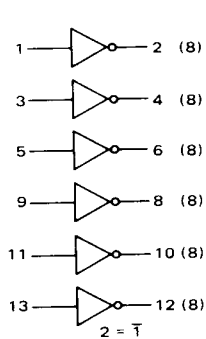

**MC841/MC941  
Hex Inverter  
(Without Output Resistors and Input Diodes)**

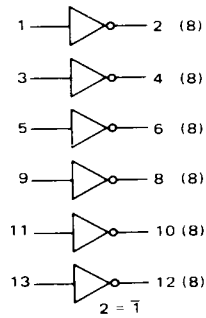

**MC846G/MC946G  
MC849G/MC949G  
Quad Inverter**

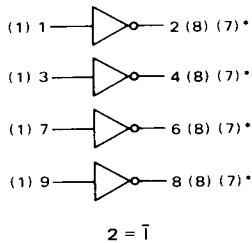

**MC1820  
High Voltage  
Hex Inverter  
(Without Output Resistors)**

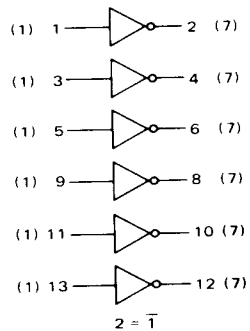

# BUFFERS

**MC832/MC932  
Expandable Dual 4-Input Buffer**

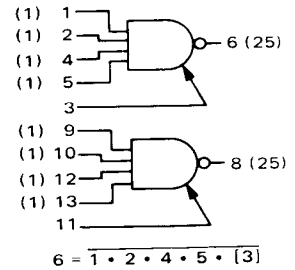

**MC832G/MC932G  
Expandable Dual 3-2 Input Buffer**

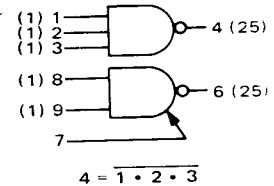

**MC857/MC957  
Quad 2-Input Buffers**

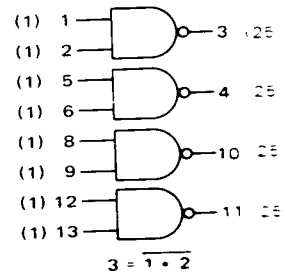

# COUNTERS

**MC838/MC938**  
Decade Counter

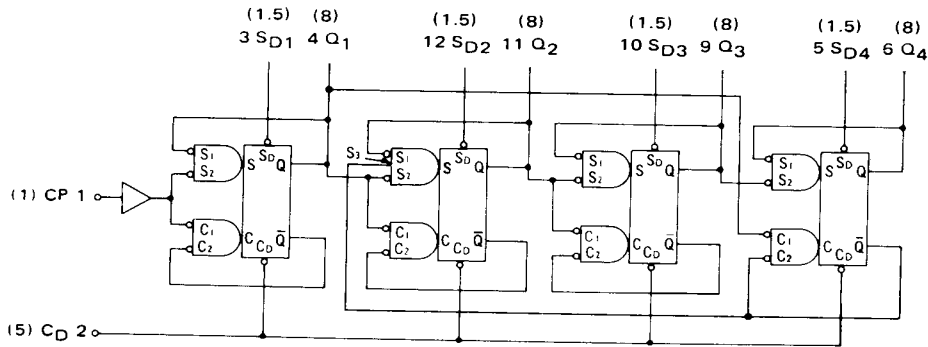

DECODING LOGIC

0	$\bar{Q}_1$	$\bar{Q}_2$	$\bar{Q}_3$	$\bar{Q}_4$
1	$Q_1$	$\bar{Q}_2$	$\bar{Q}_3$	$\bar{Q}_4$
2	$\bar{Q}_1$	$Q_2$	$\bar{Q}_3$	$\bar{Q}_4$
3	$Q_1$	$Q_2$	$\bar{Q}_3$	$\bar{Q}_4$
4	$\bar{Q}_1$	$\bar{Q}_2$	$Q_3$	$\bar{Q}_4$
5	$Q_1$	$\bar{Q}_2$	$Q_3$	$\bar{Q}_4$
6	$\bar{Q}_1$	$Q_2$	$Q_3$	$\bar{Q}_4$
7	$Q_1$	$Q_2$	$Q_3$	$\bar{Q}_4$
8	$\bar{Q}_1$			$Q_4$
9	$Q_1$			$Q_4$

**MC839/MC939**  
Divide-by-Sixteen Counter

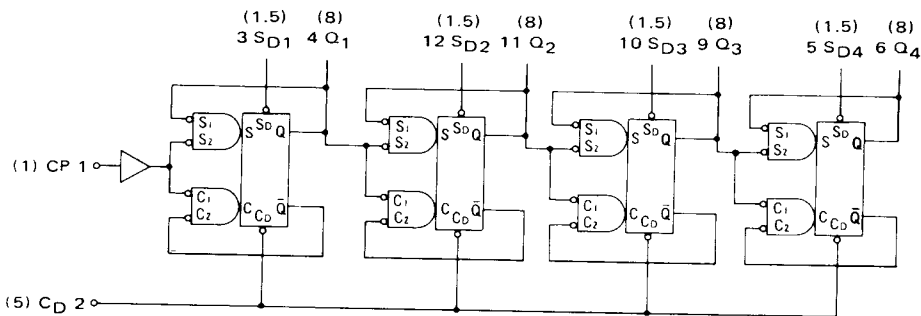

DECODING LOGIC

0	$\bar{Q}_1$	$\bar{Q}_2$	$\bar{Q}_3$	$\bar{Q}_4$
1	$Q_1$	$\bar{Q}_2$	$\bar{Q}_3$	$\bar{Q}_4$
2	$\bar{Q}_1$	$Q_2$	$\bar{Q}_3$	$\bar{Q}_4$
3	$Q_1$	$Q_2$	$\bar{Q}_3$	$\bar{Q}_4$
4	$\bar{Q}_1$	$\bar{Q}_2$	$Q_3$	$\bar{Q}_4$
5	$Q_1$	$\bar{Q}_2$	$Q_3$	$\bar{Q}_4$
6	$\bar{Q}_1$	$Q_2$	$Q_3$	$\bar{Q}_4$
7	$Q_1$	$Q_2$	$Q_3$	$\bar{Q}_4$
8	$\bar{Q}_1$	$\bar{Q}_2$	$\bar{Q}_3$	$Q_4$
9	$Q_1$	$\bar{Q}_2$	$\bar{Q}_3$	$Q_4$
10	$\bar{Q}_1$	$Q_2$	$\bar{Q}_3$	$Q_4$
11	$Q_1$	$Q_2$	$\bar{Q}_3$	$Q_4$
12	$\bar{Q}_1$	$\bar{Q}_2$	$Q_3$	$Q_4$
13	$Q_1$	$\bar{Q}_2$	$Q_3$	$Q_4$
14	$\bar{Q}_1$	$Q_2$	$Q_3$	$Q_4$
15	$Q_1$	$Q_2$	$Q_3$	$Q_4$

# EXPANDERS

**MC833/MC933**  
Dual 4-Input Expander

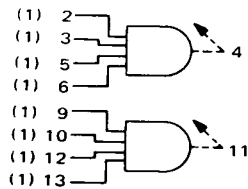

**MC833G/MC933G**  
Dual 4-3 Input Expander

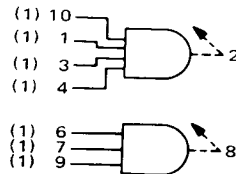

**MC847/MC947**  
Quad 2-Input Gate Expander

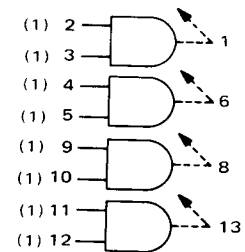



# PULSE TRIGGERED BINARY

## MC850/MC950 Pulse Triggered Binary

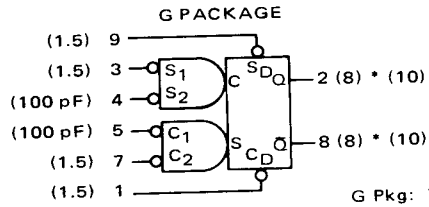
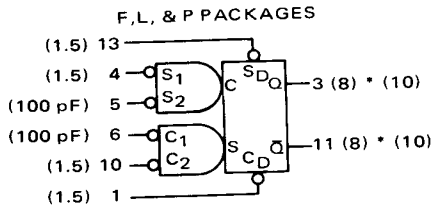

\* Applies to MC950

### SYNCHRONOUS TRUTH TABLE

		t <sub>n</sub>		t <sub>n+1</sub>
S <sub>1</sub>	S <sub>2</sub>	C <sub>1</sub>	C <sub>2</sub>	Q
0	0	0	0	U
1	X	1	X	Q <sub>n</sub>
X	1	X	1	Q <sub>n</sub>
0	1	1	0	Q <sub>n</sub>
0	0	X	1	1
0	0	1	X	1
1	X	0	0	0
X	1	0	0	0

### ASYNCHRONOUS TRUTH TABLE

S <sub>D</sub>	C <sub>D</sub>	Q	Q̄
1	1	NC	NC
0	1	1	0
1	0	0	1
0	0	1	1

0 = low state (more negative)  
1 = high state (more positive)  
X = don't care  
U = indeterminate state  
NC = no change

### SINGLE TRIGGER TRUTH TABLE (Pins S<sub>2</sub> and C<sub>1</sub> tied together)

		t <sub>n</sub>	t <sub>n+1</sub>
S <sub>1</sub>	C <sub>2</sub>	Q	Q̄
0	0	U	U
1	0	0	0
0	1	1	1
1	1	Q <sub>n</sub>	Q <sub>n</sub>