



AC-DC UL/cUL ADAPTOR DC 18V 350mA



REV. Status

REVISION - 10/24/01 RJ
REVISION A CHANGED INPUT TO 11W 02/28/02 RJ
REVISION B REVISED PLUG LOCATION. ADDED RoHS 05/23/06 MP

A. Electrical specifications

1. Input voltage: AC 120V ±10% 60Hz ±0.5Hz
2. Output voltage and current: DC 18V at 350mA

V _{in}	100% Load	No Load
108	14.0VDC MIN	-
120	17.5-18.5VDC	24.0VDC MAX
132	-	27.0VDC MAX

NOTE: Specification applies after 10 minutes warm-up with full load and at any operating temperature.

3. Operating temperature: -10°C to +40°C
4. Storage temperature: -20°C to +85°C
5. Operating and Storage Humidity: 0 to 95% without condensation
6. Withstand voltage: AC 1000Vrms 1 minute @ input to output

B. Typical performance data test Condition:
T_a = +25°C measured after 10 minute warm-up with input at 120V 60Hz

C. Safety agencies
UL and cUL File No. E218172

D. Nameplate: Information is as follows:
Metallic letters on a black background

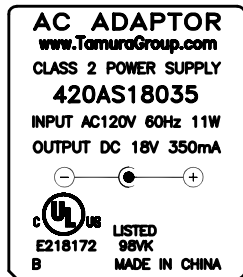

TYPICAL PERFORMANCE CHART

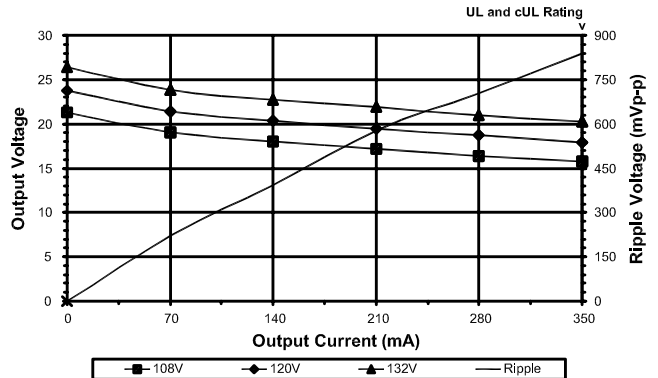

E. Mechanical Specifications

All dimensions shown are nominal unless otherwise specified

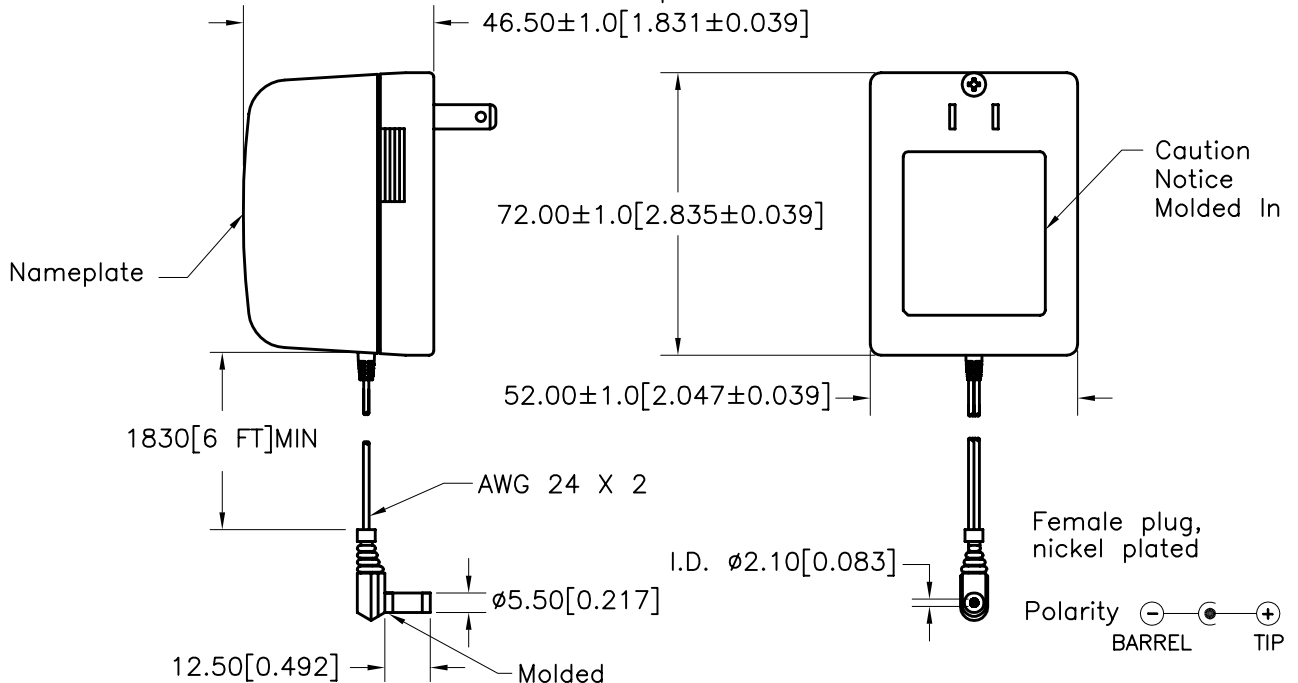

PREPARED BY:

K. BRENNAN

ENGINEER:

M. PITCHAI

QUALITY CONTROL:

T. CLEM

APPROVED:

Y. SEKIGUCHI

DWG CONTROL NO. P-A7-12947
ACAD\PS\A7129471.DWG

REV B

UL/cUL DC 18V 350mA
POWER SUPPLY

TAMURA CORPORATION OF AMERICA
43352 BUSINESS PARK DRIVE, TEMECULA, CA. 92590-6624
(951) 699-1270 FAX 9516769482

420AS18035

MODEL SPECIFICATION

DIM: mm(In) SCL: NONE SH: 1 OF 1

PROPRIETARY NOTICE: THIS DRAWING PRINT OR DOCUMENT AND SUBJECT MATTER DISCLOSED HEREIN ARE PROPRIETARY ITEMS TO WHICH TAMURA RETAINS THE EXCLUSIVE RIGHT OF DISSEMINATION, REPRODUCTION, MANUFACTURE AND SALE. THIS DRAWING, PRINT OR DOCUMENT IS SUBMITTED IN CONFIDENCE FOR CONSIDERATION BY THE RECIPIENT ALONE UNLESS PERMISSION FOR FURTHER DISCLOSURE IS EXPRESSLY GRANTED IN WRITING.