

80 A 800 V high temperature thyristor (SCR) in TO-247 package

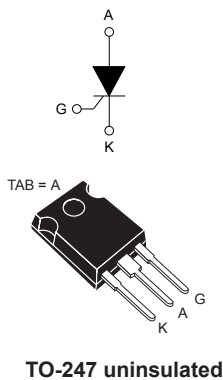

Features

- High junction temperature: $T_j = 150\text{ °C}$
- Blocking voltage: $V_{DRM} = V_{RRM} = 800\text{ V}$
- Nominal current: $I_{T(RMS)} = 80\text{ A}$
- Gate triggering current: $I_{GT\text{ max.}} = 50\text{ mA}$
- High noise immunity: $dV/dt > 1\text{ kV}/\mu\text{s}$
- Through hole package TO-247
- Increase of thermal margin due to extended T_j up to 150 °C
- Low I_D and I_R in blocking state
- [Ecopack2](#) (includes halogen free and RoHS compliance)

Applications

- AC-DC rectifier controlled bridge
- Variable speed motor drive
- Battery charging system
- AC solid state relay
- By pass switch of UPS
- Industrial welding systems

Description

Available in through hole package TO-247, the **TM8050H-8W** is an 800 V SCR thyristor suitable for applications where high power switching ($I_{T(RMS)} = 80\text{ A}$) and low power dissipation ($V_{TM} = 1.55\text{ V}$ at 160 A) are key features. These features make it ideal for motorbike voltage regulator, by-pass AC switch, controlled rectifier bridge, solid state relay, battery charger, welding equipment and motor driver applications.

Product status link	
TM8050H-8W	
Product summary	
$I_{T(RMS)}$	80 A
V_{DRM}/V_{RRM}	800 V
I_{GT}	50 mA
T_j	150 °C

1 Characteristics

Table 1. Absolute ratings (limiting values)

Symbol	Parameter		Value	Unit
$I_{T(RMS)}$	RMS on-state current (180 ° conduction angle)		80	A
$I_{T(AV)}$	Average on-state current (180 ° conduction angle)			
I_{TSM}	Non repetitive surge peak on-state current, $V_R = 0$ V	$t_p = 8.3$ ms	731	A
		$t_p = 10$ ms		
I^2t	I^2t value for fusing		2245	A^2s
V_{RRM} / V_{DRM}	Maximum repetitive symmetric blocking voltage		800	V
V_{DSM}	Maximum non-repetitive direct blocking voltage	$t_p = 10$ ms	1000	V
di/dt	Critical rate of rise of on-state current $I_G = 2 \times I_{GT}$, $t_r \leq 100$ ns	$f = 50$ Hz	200	$A/\mu s$
I_{GM}	Peak gate current	$t_p = 20$ μs	8	A
$P_{G(AV)}$	Average gate power dissipation		1	W
V_{RGM}	Maximum peak reverse gate voltage		5	V
T_{stg}	Storage junction temperature range		-40 to +150	°C
T_j	Maximum operating junction temperature		-40 to +150	°C

Table 2. Electrical characteristics ($T_j = 25$ °C unless otherwise specified)

Symbol	Test Conditions		Value	Unit
I_{GT}	$V_D = 12$ V, $R_L = 33$ Ω	Min.	2.5	mA
		Max.	50	
V_{GT}	$V_D = 12$ V, $R_L = 33$ Ω	Max.	1.5	V
V_{GD}	$V_D = V_{DRM}$, $R_L = 3.3$ k Ω	$T_j = 150$ °C	Min.	0.2
I_H	$I_T = 500$ mA, gate open		Max.	100
I_L	$I_G = 1.2 \times I_{GT}$		Max.	125
t_{gt}	$I_T = 80$ A, $V_D = V_{DRM}$, $I_G = 200$ mA, $di_G/dt = 0.2$ A/ μs		Typ.	3
dV/dt	$V_D = 67\%$ V_{DRM} , gate open	$T_j = 150$ °C	Min.	1000
t_q	$I_T = 33$ A, $di_T/dt = 10$ A/ μs , $V_R = 75$ V, $V_D = 400$ V, $dV_D/dt = 20$ V/ μs , $t_p = 100$ μs	$T_j = 150$ °C	Max.	150

Table 3. Static characteristics

Symbol	Test conditions		Value	Unit
V_{TM}	$I_{TM} = 160$ A, $t_p = 380$ μs	$T_j = 25$ °C	Max.	1.55
V_{TO}	On state threshold voltage	$T_j = 150$ °C	Max.	
R_D	On state dynamic resistance	$T_j = 150$ °C	Max.	5.5
I_{DRM}	$V_D = V_{DRM} = V_R = V_{RRM} = 800$ V	$T_j = 25$ °C	Max.	20
I_{RRM}		$T_j = 150$ °C	Max.	2.5

Table 4. Thermal parameters

Symbol	Parameter	Value	Unit
$R_{th(j-c)}$	Junction to case (DC,max.)	0.30	°C/W
$R_{th(j-a)}$	Junction to ambient DC (typ.)	50	

1.1 Characteristics curves

Figure 1. Maximum average power dissipation versus average on-state current

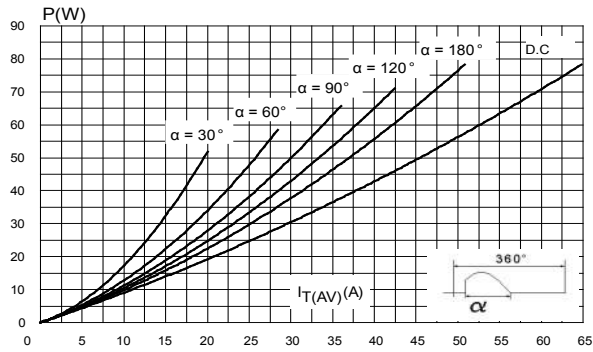

Figure 2. Average and DC on-state current versus case temperature

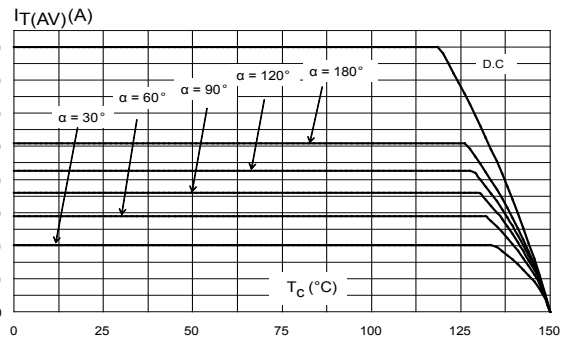

Figure 3. Average and D.C. on state current versus ambient temperature

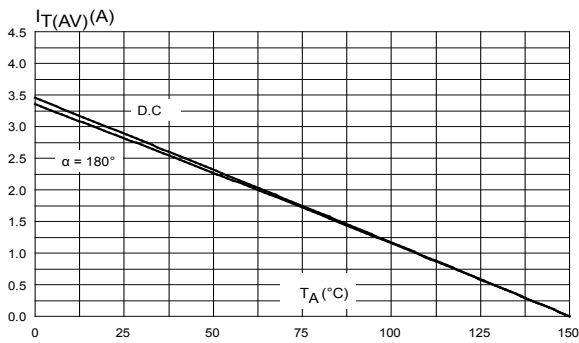

Figure 4. On-state characteristics (maximum values)

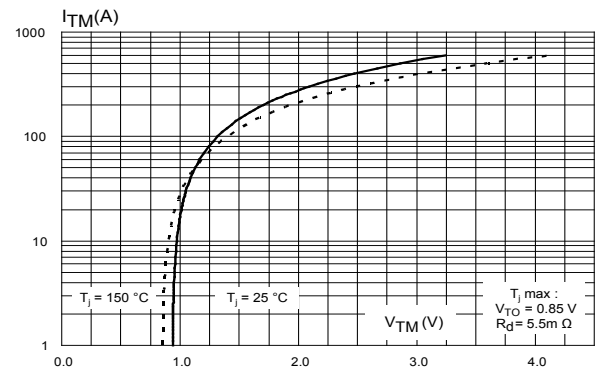

Figure 5. Relative variation of thermal impedance junction to case and junction to ambient versus pulse duration

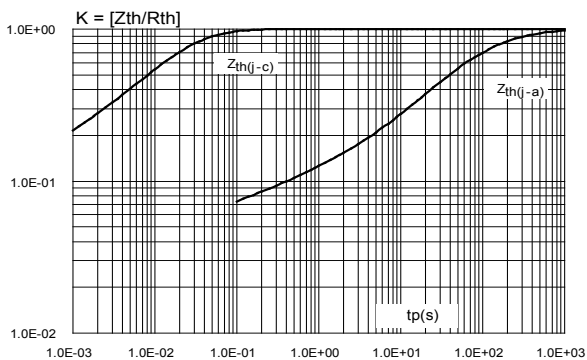

Figure 6. Relative variation of gate trigger current and gate voltage versus junction temperature

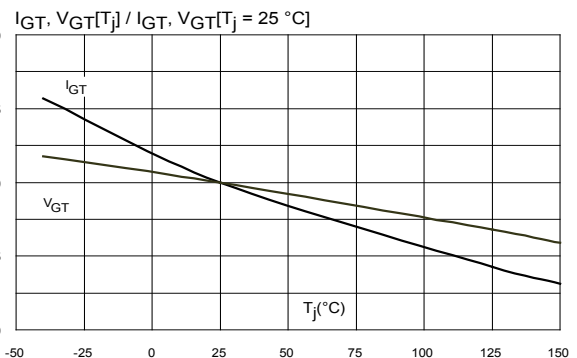

Figure 7. Relative variation of holding current and latching current versus junction temperature (typical values)

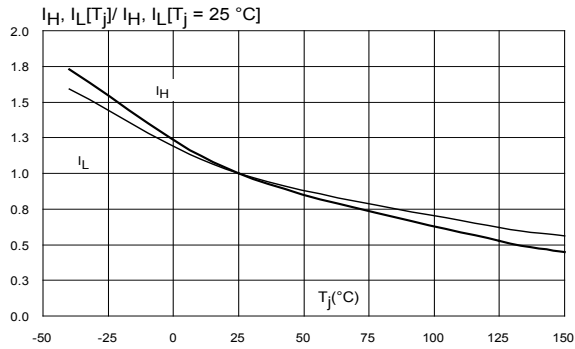

Figure 8. Surge peak on state current versus number of cycles

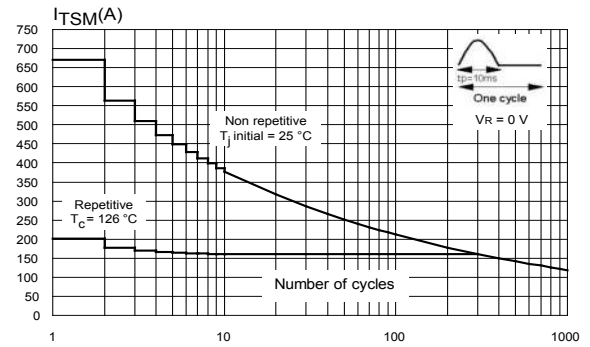

Figure 9. Non repetitive surge peak on state current for a half cycle sine pulse versus pulse width $t_p < 10\text{ms}$

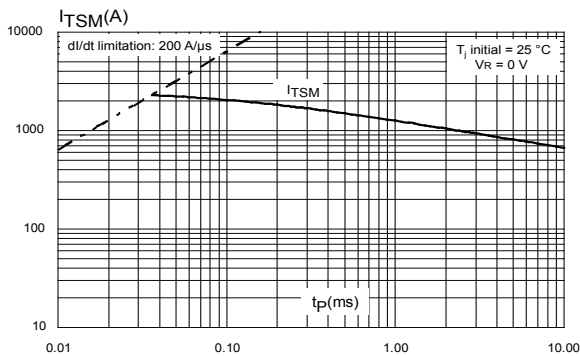

Figure 10. Relative variation of leakage current versus junction temperature for different values of blocking voltage

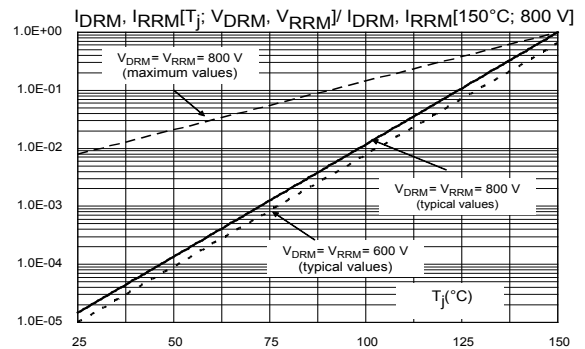
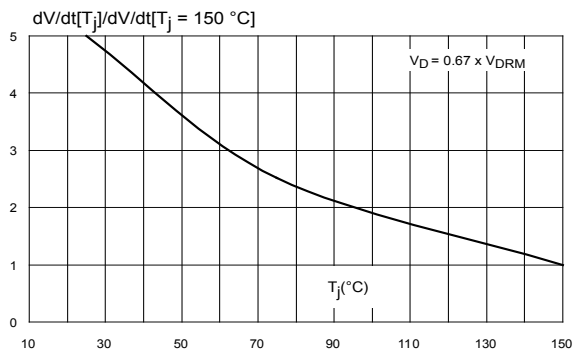

Figure 11. Relative variation of static dV/dt immunity versus junction temperature (typical values)



2 Package information

In order to meet environmental requirements, ST offers these devices in different grades of **ECOPACK** packages, depending on their level of environmental compliance. ECOPACK specifications, grade definitions and product status are available at: www.st.com. ECOPACK is an ST trademark.

2.1 TO-247 package information

- Epoxy meets UL 94,V0
- Recommended torque value: 0.8 N·m
- Maximum torque value: 1 N·m

Figure 12. TO-247 package outline

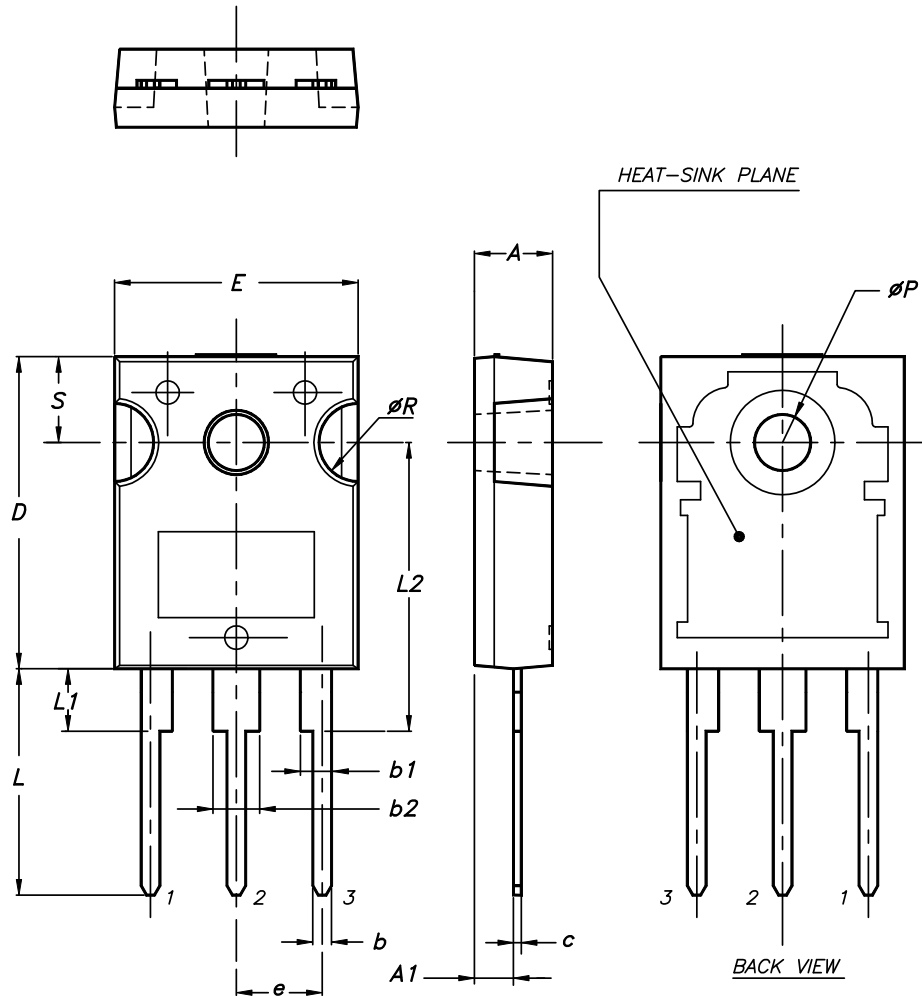

0075325_9

Table 5. TO-247 package mechanical data

Dim.	Dimensions					
	Millimeters			Inches ⁽¹⁾		
	Min.	Typ.	Max.	Min.	Typ.	Max.
A	4.85		5.15	0.1909		0.2028
A1	2.20		2.60	0.0866		0.1024
b	1.0		1.40	0.0394		0.0551
b1	2.0		2.40	0.0787		0.0945
b2	3.0		3.40	0.1181		0.1339
c	0.40		0.80	0.0157		0.0315
D ⁽²⁾	19.85		20.15	0.7815		0.7933
E	15.45		15.75	0.6083		0.6201
e	5.30	5.45	5.60	0.2087	0.2146	0.2205
L	14.20		14.80	0.5591		0.5827
L1	3.70		4.30	0.1457		0.1693
L2		18.50			0.7283	
ØP ⁽³⁾	3.55		3.65	0.1398		0.1437
ØR	4.50		5.50	0.1772		0.2165
S	5.30	5.50	5.70	0.2087	0.2165	0.2244

1. Inch dimensions given only for reference
2. Dimension D plus gate protrusion does not exceed 20.5 mm
3. Resin thickness around the mounting hole is not less than 0.9 mm

3 Ordering information

Figure 13. Ordering information scheme

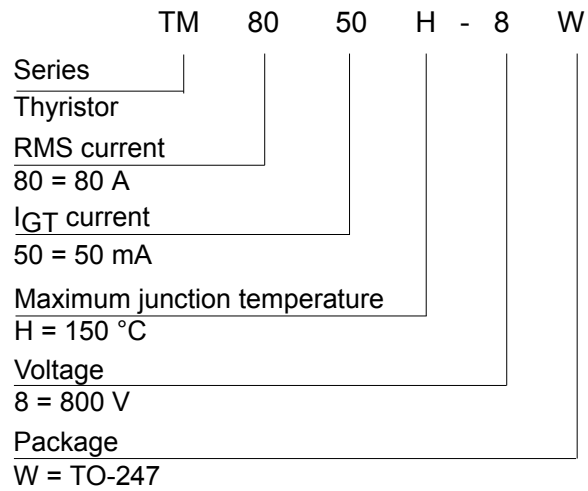

Table 6. Ordering information

Order code	Marking	Package	Weight	Base qty.	Delivery mode
TM8050H-8W	TM8050H8	TO-247	4.43 g	30	Tube

Revision history

Table 7. Document revision history

Date	Revision	Changes
03-May-2016	1	Initial release.
08-Aug-2019	2	Updated Table 1, Figure 8 and Figure 9. Minor text change.
04-Jan-2023	3	Updated Table 1 and Figure 1.

IMPORTANT NOTICE – READ CAREFULLY

STMicroelectronics NV and its subsidiaries (“ST”) reserve the right to make changes, corrections, enhancements, modifications, and improvements to ST products and/or to this document at any time without notice. Purchasers should obtain the latest relevant information on ST products before placing orders. ST products are sold pursuant to ST’s terms and conditions of sale in place at the time of order acknowledgment.

Purchasers are solely responsible for the choice, selection, and use of ST products and ST assumes no liability for application assistance or the design of purchasers’ products.

No license, express or implied, to any intellectual property right is granted by ST herein.

Resale of ST products with provisions different from the information set forth herein shall void any warranty granted by ST for such product.

ST and the ST logo are trademarks of ST. For additional information about ST trademarks, refer to www.st.com/trademarks. All other product or service names are the property of their respective owners.

Information in this document supersedes and replaces information previously supplied in any prior versions of this document.

© 2023 STMicroelectronics – All rights reserved