

DLP5530PROJTGQ1EVM Evaluation Module User's Guide

The DLP5530PROJTGQ1EVM Evaluation Module (EVM) is a complete electronic and optical subsystem designed to control and interface with the DLP5530-Q1 chipset. The DLP5530-Q1 chipset consists of the DLP5530-Q1, the DLPC230-Q1, and the TPS99000-Q1. This chipset is combined with illumination and projection optics, RGB LEDs, and a photodiode and can be used to develop an automotive grade projector for applications such as windshield cluster display and transparent window displays where a holographic optical element (HOE) is used as the screen technology. This EVM uses narrow band LED illumination designed to work more efficiently with HOE films. This projector offers high brightness and high contrast of up to 2000:1 in a compact package of about 1 liter. It is made of robust metal housing and uses all glass optical elements, but these could potentially be traded for more cost effective plastic options in a production design.

The DLP5530PROJTGQ1EVM is not a production design. It is intended for evaluation only.



Figure 1. The DLP5530PROJTGQ1EVM

The DLP5530Q1EVM electronics EVM pairs with 3 different optical module configurations, all available as standalone EVMs. The different options are listed below in [Table 1](#).

Table 1. Optical Module EVM Descriptions

EVM Part Number	Typical Application	Key Features
DLP5530PGUQ1EVM	Head up display	Short throw distance for creating HUD images on a diffuser screen
DLP5530PROJQ1EVM	Full color transparent window display	Variable throw distance for creating large images of scalable sizes
DLP5530PROJTGQ1EVM	Holographic cluster display	Direct green LED for narrow band illumination of holographic optical elements

Contents

1	User Guide Overview.....	3
1.1	What is in the DLP5530PROJTGQ1EVM EVM.....	3
1.2	Specifications	10
2	Quick Start	12
2.1	Kit Assembly Instructions.....	12
2.2	Software Installation	13
2.3	Powering-Up EVM.....	13
2.4	Connecting EVM to the DLPC230-Q1 Control Program	13
2.5	Steps to Reprogram the Onboard Flash Memory.....	14
3	Optical Engine Specifications.....	14
4	REACH Compliance	16

List of Figures

1	The DLP5530PROJTGQ1EVM	1
2	DLP5530PROJTGQ1EVM Controller PCB.....	3
3	DLP5530PROJTGQ1EVM Illumination Driver PCB.....	6
4	EVM Cables	8
5	EVM Cable Connections	12
6	Connecting to the DLPC230-Q1 Using the DLPC230-Q1 Automotive Control Program	13
7	DLPC230-Q1 Automotive Control Program Communication Settings	14
8	DLP5530PROJTGQ1EVM Optical Module	15

List of Tables

1	Optical Module EVM Descriptions	1
2	Controller PCB Ports	4
3	Controller LED Indicators	4
4	Controller PCB Switches.....	4
5	Illumination Driver PCB Ports	7
6	Illumination Driver Header Pins.....	7
7	EVM Cables	8
8	Electrical Specifications	10
9	EVM Components Which are Not Rated for –40°C to 105°C	10
10	Typical Timing for Supported Source Resolutions.....	11
11	Optical Module Specifications	15
12	Included LEDs	16
13	Optical Engine SVHC Components.....	16

Trademarks

All trademarks are the property of their respective owners.

1 User Guide Overview

This user's guide presents an overview and general description of the DLP5530PROJTGQ1EVM and provides first steps for getting started using the EVM.

1.1 What is in the DLP5530PROJTGQ1EVM EVM

The DLP5530PROJTGQ1EVM consists of a controller PCB, an illumination driver PCB, cables, and a USB to SPI adapter. It also includes an optical module designed to combine with the electronic subsystem for evaluation of a fully functioning projector in an automotive setting.

1.1.1 Controller PCB

The controller PCB shown in [Figure 2](#) includes the DLP5530-Q1 DMD, the DLPC230-Q1 DMD Controller, and the TPS99000-Q1. It supports video inputs from either a micro HDMI or OpenLDI interface and provides the formatting and control to display the video on the DLP5530-Q1 DMD. The EVM can be controlled with either a SPI or an I²C interface. The SPI or I²C interface can also be used to reprogram the serial Flash that is used to store DLPC230-Q1 software and configuration. An optional second SPI port is provided for monitoring the TPS99000-Q1. The EVM has an external photodiode input that is used to control white point and brightness over a wide dimming range. An optional second photodiode input is also provided. The EVM includes a flex interface to control and monitor the illumination driver PCB. It also provides an optional interface for thermistors on the red, green and blue illuminator PCBs that can be used to monitor the temperatures of the illuminators.

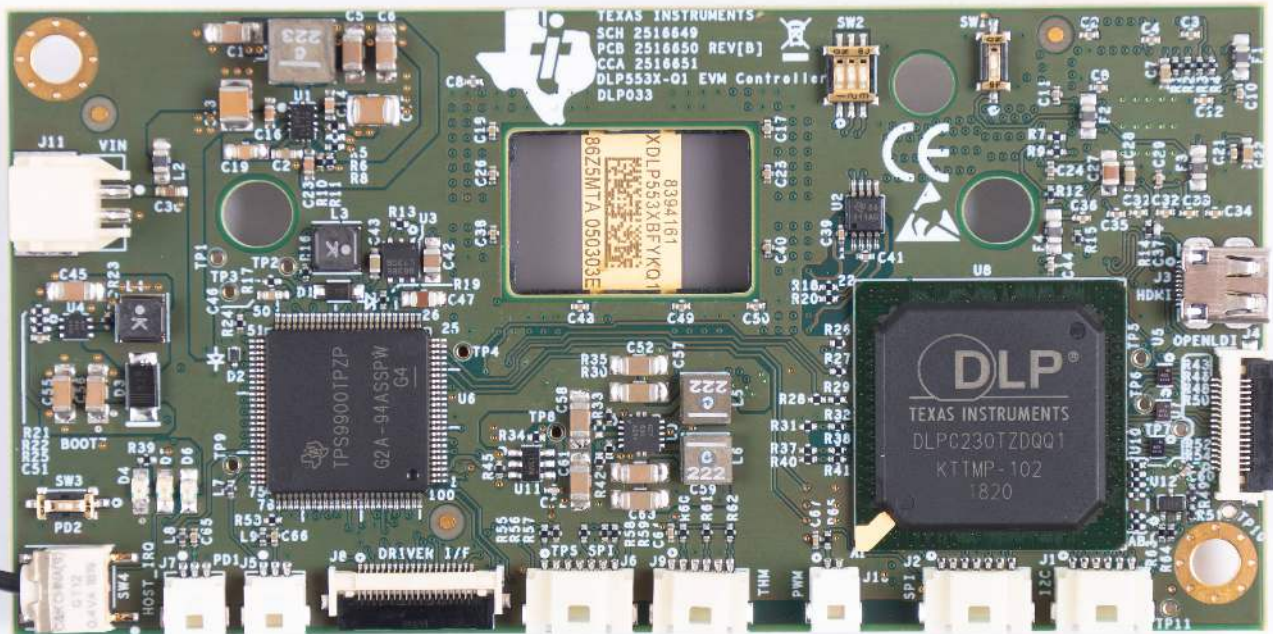

Figure 2. DLP5530PROJTGQ1EVM Controller PCB

The controller PCB contains the ports listed in [Table 2](#). Indicator LEDs are listed in [Table 3](#).

Table 2. Controller PCB Ports

SCHEMATIC REFERENCE	FUNCTION
J1	Host I ² C, PROJ_ON, HOLD_BOOT, HOST_IRQ
J2	Host SPI
J3	Micro HDMI
J4	OpenLDI (Flex connector)
J5	Photodiode 1
J6	TPS99000-Q1 SPI Debug
J7	Photodiode 2
J8	HUD Driver Interface
J9	LED Thermistor
J10	Fan PWM output ⁽¹⁾
J11	Formatter Controller Power

⁽¹⁾ Port unused for RGB display applications. Cable not provided.

Table 3. Controller LED Indicators

SCHEMATIC REFERENCE	FUNCTION
D4 (Green)	Input power to controller (from illumination driver) Off: No power connected On: Power connected
D5 (Green)	PROJ_ON Off: System Off On: System On
D6 (Red)	HOST_IRQ Off: Interrupt not asserted On: Interrupt asserted

The controller PCB switches are listed in [Table 4](#). SW4 is a toggle switch for PROJ_ON which is used to turn on and off the electronics. Note that parts of the board are still powered when PROJ_ON is in the off position. SW1, SW2 and SW3 are dip switches that control the states of configuration signals the DLPC230-Q1 reads when it comes out of reset. These switches should be set based on the desired configuration options.

Table 4. Controller PCB Switches

SCHEMATIC REFERENCE / SIGNAL NUMBER	FUNCTION
SW1 (1)	Spread Spectrum Enable Off: Disabled On: Enabled
SW2 (1)	Host Port Checksum Select Off: CRC On: Checksum
SW2 (2)	Host Interface Select Off: Host SPI On: Host I ² C
SW2 (3)	Host SPI Mode Off: Mode 0 or 3 On: Mode 1 or 2
SW3	Hold in Boot Off: Do not hold in boot (continue to main application) On: Hold in boot

Table 4. Controller PCB Switches (continued)

SCHEMATIC REFERENCE / SIGNAL NUMBER	FUNCTION
SW4	PROJ_ON Off: Turn off system On: Turn on system On state is toward the outer edge of the board Figure 2

1.1.2 Illumination Driver PCB

The illumination driver PCB shown in [Figure 3](#) is controlled and monitored by the controller PCB over a flex cable. Power can be input to the illumination driver from a bench top supply. The illumination driver provides reverse bias protection and supplies power to the controller PCB over a separate cable. The illumination driver PCB regulates the input power to 6.5 V or 8 V prior to the illumination driver circuitry. The illumination driver has outputs for red, green and blue illuminators. These are typically LEDs, but it is possible other illuminators could be used. See [Section 1.2.1](#) for input and output specifications of the EVM. Depending on operating conditions, some parts and surfaces of the PCB can be hot.

CAUTION



Hot surface. Contact may cause burns. Do not touch!

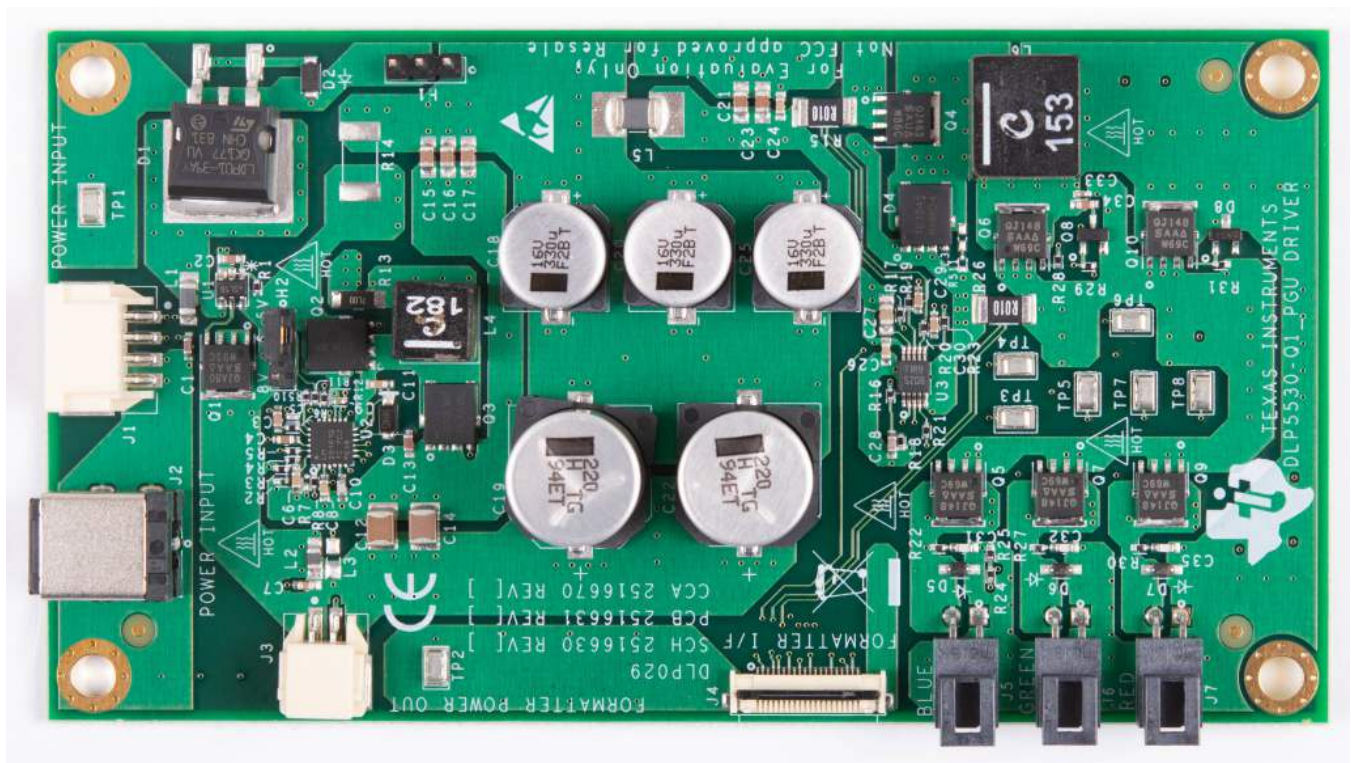

Figure 3. DLP5530PROJTGQ1EVM Illumination Driver PCB

The illumination driver PCB contains the ports listed in [Table 5](#).

Table 5. Illumination Driver PCB Ports

SCHEMATIC REFERENCE	FUNCTION
J1	Input Power
J2	Input Power (optional)
J3	Controller Power
J4	Controller-Driver Control Interface
J5	Blue Illumination Output - High current output up to 6 A, locking and keyed connector
J6	Green Illumination Output - High current output up to 6 A, locking and keyed connector
J7	Red Illumination Output - High current output up to 6 A, locking and keyed connector

The illumination driver PCB contains the headers listed in [Table 6](#). H2 selects the illumination drive voltage. Place a jumper across pins 1 and 2 for 6.5-V drive. Place a jumper across pins 2 and 3 for 8-V drive. Do not hot-swap this jumper, remove/replace only with power disconnected from the board.

Table 6. Illumination Driver Header Pins

HEADER	PIN1	PIN2	PIN3
H1	Pre-regulated drive voltage (6.5 V or 8 V)	GND	GND
H2	Feedback voltage connection for 6.5-V drive	Pre-regulator feedback voltage	Feedback voltage connection for 8-V drive

1.1.3 EVM Cables

The DLP5530PROJTGQ1EVM kit contains the cables and Cheetah USB to SPI adapter listed in [Table 7](#) and shown in [Figure 4](#).



Figure 4. EVM Cables

Table 7. EVM Cables

NAME	REFERENCE	QUANTITY
Input Power Cable	A	1
Cheetah™ SPI Host Adapter	B	1
Host SPI Cable	C	1
Host I ² C Cable (Includes PROJ_ON, HOLD_BOOT, HOST_IRQ signals)	D	1
Green Illuminator Power Cable	E	2

Table 7. EVM Cables (continued)

NAME	REFERENCE	QUANTITY
Blue Illuminator Power Cable	F	2
Red Illuminator Power Cable	G	2
Photodiode Cable	I	1
Driver to Formatter Controller Power Cable	J	1
Formatter Controller to Driver Control Flex	K	1
Micro HDMI Cable	M	1

1.2 Specifications

1.2.1 Electrical Specifications

Table 8. Electrical Specifications

PARAMETER	MIN	NOM	MAX	UNIT
Input				
Voltage	8	12	18	V
Power ⁽¹⁾		12	40	W
LED Pre-Regulator Output				
Voltage	6.5 or 8 ⁽²⁾			V
Illumination Driver Output Load				
Voltage (Per LED Color Output)			7.5	V
Current (Per LED Color Output)			6	A
Temperature				
Operating DMD Temperature ⁽³⁾	-40		105 ⁽⁴⁾	°C

⁽¹⁾ Conditions for nominal power: white balanced LED current up to 6 A, LED forward voltage = 3.5 V, display duty cycle = 90/10.

⁽²⁾ Pre-regulator output voltage is set by the jumper position of header H2. See [Table 6](#).

⁽³⁾ Care must be taken to ensure that individual components and PCB do not exceed their maximum temperature when driving high-power load.

⁽⁴⁾ Some components are only rated to 85°C. Refer to [Table 9](#) for a list of these components.

1.2.2 Component Temperature Ratings

The PCB materials and most of the PCB components are rated to operate between -40°C to 105°C, including the DLP5530-Q1, the DLPC230-Q1, and the TPS99000-Q1.

Some components on board, such as switches, connectors, and indicator LEDs, do not meet this temperature rating. The specifications for EVM components which are not rated between -40°C to 105°C are listed in [Table 9](#). Please refer to the EVM bill of materials to review the temperature specifications of all components used in the EVM design.

Table 9. EVM Components Which are Not Rated for -40°C to 105°C

Board	Reference	Part Number	Manufacturer	Description	Temperature Minimum (°C)	Temperature Maximum (°C)
Controller	D4, D5	LTST-C171KGKT	Lite-On	LED, GREEN 0805	-55	85
Controller	D6	LTST-C171KRKT	Lite-On	LED, RED 0805	-55	85
Controller	J3	685119248123	Würth	CONN MICRO HDMI RIGHT ANGLE	-40	85
Controller	SW1	CVS-02TB	Copal Electronics Inc	SWITCH DIP SLIDE 2-POS 1 MM 6 V	-40	85
Controller	SW2	CVS-03TB	Copal Electronics Inc	SWITCH DIP SLIDE 3-POS 1 MM 6 V	-40	85
Controller	SW3	CVS-01TB	Copal Electronics Inc	SWITCH DIP SLIDE 1-POS 1 MM 6 V	-40	85
Controller	SW4	GT12MSCBE	C&K Comp	SWITCH, SPST, GULL	-30	85
Controller	U5, U7, U10, U503, U504	PCMF2HDMI2SZ	Nexperia	COMMON MODE CHOKE 4LN SMD ESD	-40	85
Controller	U501	TFP401AIPZPRQ1	Texas Instruments	IC PANELBUS DVI RCVR 100-HTQFP	-40	85
Illumination Driver	J2	PJ-082BH	CUI Inc	CONN PWR JACK 2.5X5.5MM SOLDER	-25	85

The controller and illumination driver PCBs have a UL flame rating of 130°C maximum.

The DLP5530PROJTGQ1EVM is not a production design. It is intended for evaluation only. The DLP5530PROJTGQ1EVM is only designed to operate at a maximum of 40°C ambient temperature, but with a custom thermal solution the DLP5530-Q1 chipset and accompanying optical engine can be designed to operate at up to 105°C.

1.2.3 Input Video Specifications

The following input video resolutions are supported on the HDMI and OpenLDI interfaces. These input video resolutions are programmed in the Extended Display Identification Data (EDID) EEPROM for the EVM's HDMI interface allowing a connected computer to read the supported resolutions and timing. Note that some computers may not be able to output all of these resolutions, in particular 576 × 288.

- 1152 × 1152
- 1152 × 576
- 576 × 288

The input source timing specified in the EVM's HDMI interface EDID are specified in [Table 10](#). These timing parameters are also recommended for the OpenLDI interface.

Table 10. Typical Timing for Supported Source Resolutions

Horizontal Resolution	Vertical Resolution	Horizontal Blanking				Vertical Blanking				Vertical Rate (Hz)	Pixel Clock (MHz)
		Total	Sync (Pixel Clocks)	Back Porch (Pixel Clocks)	Front Porch (Pixel Clocks)	Total	Sync (Lines)	Back Porch (Lines)	Front Porch (Lines)		
1152	1152	80	8	32	40	33	8	22	3	60	87.59
1152	576	80	8	32	40	17	8	6	3	60	43.83
576	288	322	8	154	160	181	8	158	15	59.98	25.26

1.2.4 SPI and I²C Timing

For more information on SPI and I²C specifications, see the DLPC230-Q1 data sheet.

2 Quick Start

Use the following instructions to setup the DLP5530PROJTGQ1EVM and PC.

2.1 Kit Assembly Instructions

A diagram of all connections is shown in [Figure 5](#).

1. Connect the controller to driver control interface flex to the controller PCB (J8) and the illumination driver PCB (J4).
2. Connect the host SPI cable to the controller PCB (J2) and the Cheetah adapter. Connect the Cheetah adapter's USB cable to PC.
3. Connect the controller power cable to the controller PCB (J11) and the illumination driver PCB (J3).
4. Connect the blue illumination output cable to the illumination driver PCB (J5) to the blue illuminator in the optics engine.
5. Connect the green illumination output cable to the illumination driver PCB (J6) to the green illuminator in the optics.
6. Connect the red illumination output cable to the illumination driver PCB (J7) to the red illuminator in the optics engine.
7. Connect the photodiode cable to the controller PCB (J5) to a photodiode located in the illumination path of the optics engine.
8. Connect the Micro HDMI cable to the controller PCB (J3). Connect the Micro HDMI cable to PC HDMI port.
9. Connect the power input cable to the illumination driver PCB (J1).

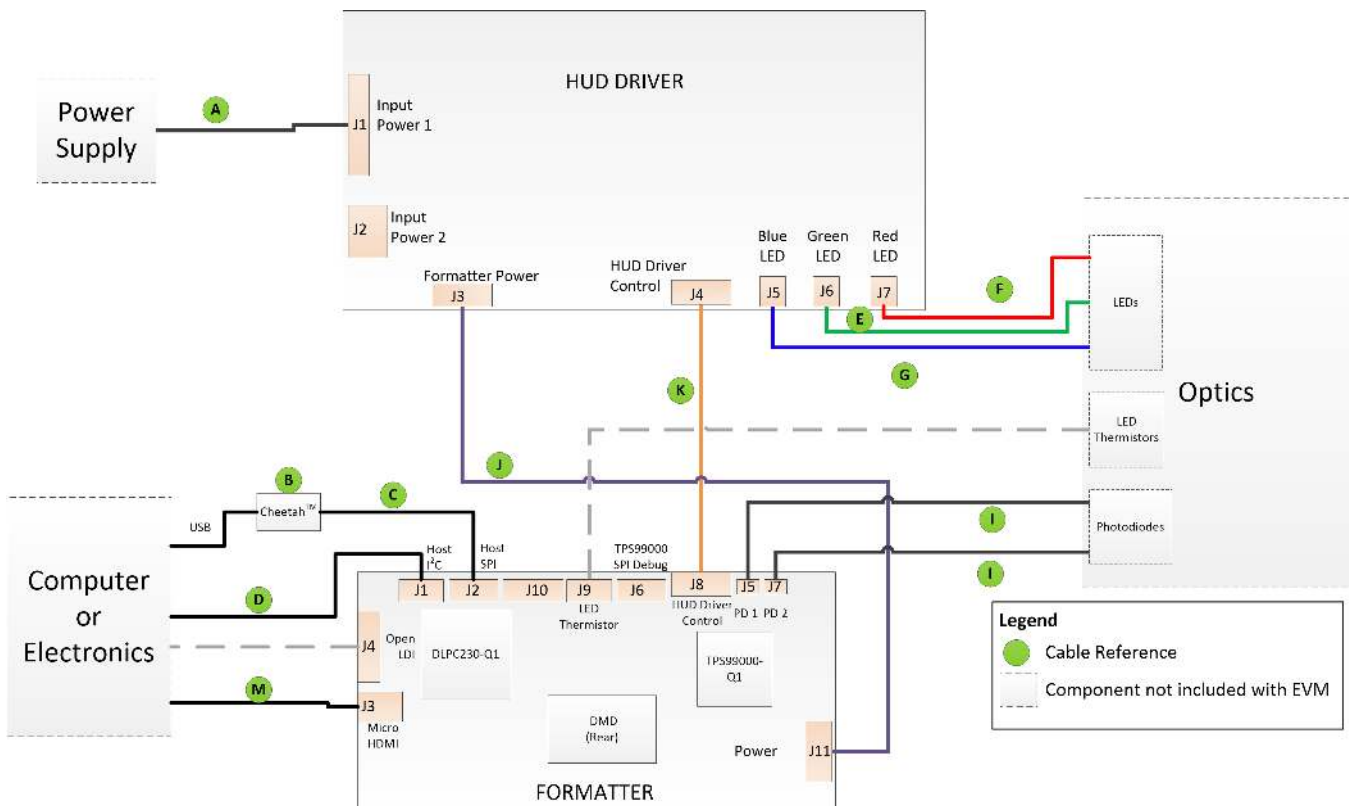

(1) Reference letters refer to cables listed in [Table 7](#).

Figure 5. EVM Cable Connections

2.2 Software Installation

1. Download and install the [DLPC230-Q1 Control Program Lite](#) from ti.com.
2. Install [Total Phase Cheetah USB adapter drivers](#) from the Total Phase website.

2.3 Powering-Up EVM

1. Connect input power cable to a power supply that meets input power specifications defined in [Table 8](#). The red wire is the V+ terminal and black wire is the V– terminal.
2. Turn on the supply power. Once powered up, a controller PCB LED indicator (D4) should illuminate green.
3. Turn the PROJ_ON switch (SW4) ON. The ON position is away from the board, and OFF is toward the board. A controller PCB LED indicator (D5) should illuminate green.

2.4 Connecting EVM to the DLPC230-Q1 Control Program

1. Start the DLPC230-Q1 Control Program Lite.
2. On the connection page set the DLPC230-Q1 Host to SPI and select the Cheetah from the drop down menu (see [Figure 6](#)). Note, the Cheetah must be connected to computer with USB cable for it to show up in the drop down box.

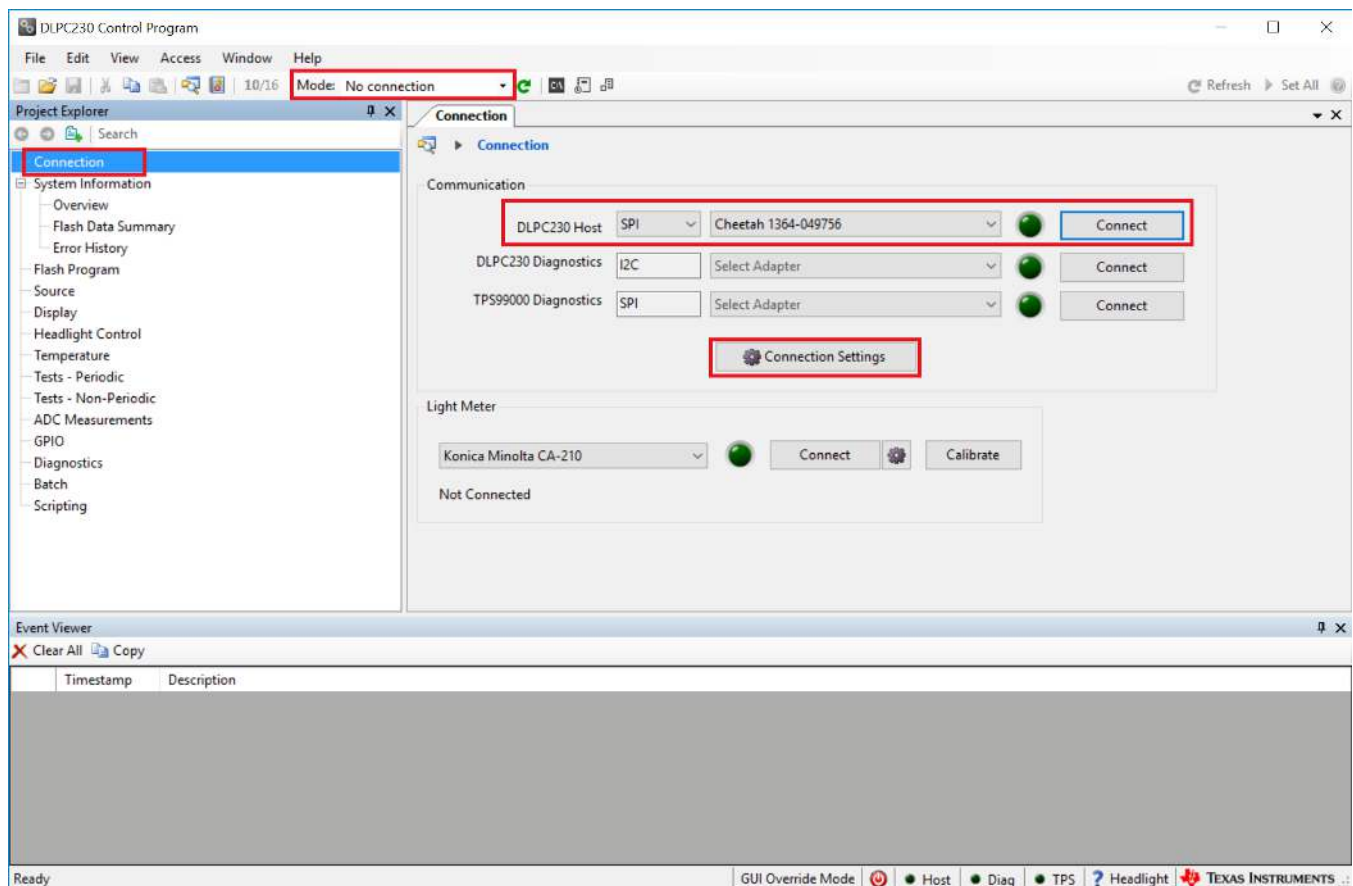

Figure 6. Connecting to the DLPC230-Q1 Using the DLPC230-Q1 Automotive Control Program

3. Select "Connection Settings" to confirm the SPI configuration shown in [Figure 7](#) matches the controller PCB switch settings described in [Table 4](#). Specifically, SPI mode and CRC/Checksum may vary based on switch settings. Press "OK" once configuration is complete.

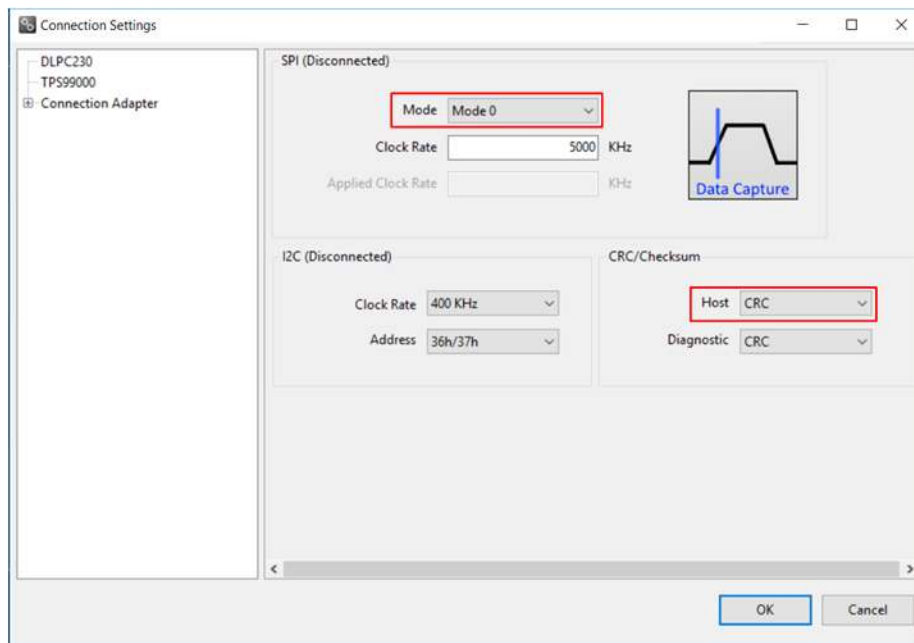

Figure 7. DLPC230-Q1 Automotive Control Program Communication Settings

4. Click the Connect button. The green circle next to the Connect button should then light up to indicate that connection was successful to the Cheetah Adapter.

2.5 Steps to Reprogram the Onboard Flash Memory

The DLP5530PROJTGQ1EVM comes with onboard serial Flash that is pre-programmed with software and basic configuration. The software and configuration can be updated by reprogramming the serial Flash with the DLPC230-Q1 Automotive Control Program. Steps to re-program the serial Flash are listed below.

1. Using the DLPC230-Q1 Automotive Control Program, which is connected to the EVM, navigate to the "Flash Program" tab.
2. Using the folder icon, select an Image File (.bin) and open it.
3. Click "Program and Verify Flash Memory."

Note that if the device is in Display mode, it will automatically be switched to Standby during programming.

3 Optical Engine Specifications

The DLP5530PROJTGQ1EVM includes an optical projection system that can be used for windshield cluster applications. The optical specifications are listed in [Table 11](#).



Figure 8. DLP5530PROJTGQ1EVM Optical Module

Table 11. Optical Module Specifications

PARAMETER	MIN	NOM	MAX	UNIT
Luminous flux output	100			lm
Throw ratio		1.80		
Throw distance	355		635	mm
Image width	200		350	mm
f/#		2.6		
MTF		40%		
Optical image offset		100%		
Light uniformity	80%			
FOFO contrast		1800:1		

Table 12. Included LEDs

Color	Manufacturer	Part Number
Red	Osram	Q8WP LE A
Green	Osram	Q8WP LE TG
Blue	Osram	Q8WP LE B

CAUTION



Possibly hazardous optical radiation emitted from this product. Do not stare at operating lamp. May be harmful to the eye.

4 REACH Compliance

In compliance with the Article 33 provision of the EU REACH regulation we are notifying you that this EVM includes component(s) containing at least one Substance of Very High Concern (SVHC) above 0.1%. These uses from Texas Instruments do not exceed 1 ton per year. The SVHC's are:

Table 13. Optical Engine SVHC Components

Component Manufacturer	Component Type	Component Part Number	SVHC Substance	SVHC CAS
Changsung Metal Co Ltd.	Aluminum rod	AL2011	Lead	7439-92-1

IMPORTANT NOTICE AND DISCLAIMER

TI PROVIDES TECHNICAL AND RELIABILITY DATA (INCLUDING DATASHEETS), DESIGN RESOURCES (INCLUDING REFERENCE DESIGNS), APPLICATION OR OTHER DESIGN ADVICE, WEB TOOLS, SAFETY INFORMATION, AND OTHER RESOURCES "AS IS" AND WITH ALL FAULTS, AND DISCLAIMS ALL WARRANTIES, EXPRESS AND IMPLIED, INCLUDING WITHOUT LIMITATION ANY IMPLIED WARRANTIES OF MERCHANTABILITY, FITNESS FOR A PARTICULAR PURPOSE OR NON-INFRINGEMENT OF THIRD PARTY INTELLECTUAL PROPERTY RIGHTS.

These resources are intended for skilled developers designing with TI products. You are solely responsible for (1) selecting the appropriate TI products for your application, (2) designing, validating and testing your application, and (3) ensuring your application meets applicable standards, and any other safety, security, or other requirements. These resources are subject to change without notice. TI grants you permission to use these resources only for development of an application that uses the TI products described in the resource. Other reproduction and display of these resources is prohibited. No license is granted to any other TI intellectual property right or to any third party intellectual property right. TI disclaims responsibility for, and you will fully indemnify TI and its representatives against, any claims, damages, costs, losses, and liabilities arising out of your use of these resources.

TI's products are provided subject to TI's Terms of Sale (www.ti.com/legal/termsofsale.html) or other applicable terms available either on ti.com or provided in conjunction with such TI products. TI's provision of these resources does not expand or otherwise alter TI's applicable warranties or warranty disclaimers for TI products.

Mailing Address: Texas Instruments, Post Office Box 655303, Dallas, Texas 75265
Copyright © 2019, Texas Instruments Incorporated