

# TPS4333xEVM

## Contents

1	Introduction .....	2
2	Setup .....	2
	2.1 Input/Output Connector Description .....	2
	2.2 Setup .....	4
	2.3 Operation .....	5
3	Board Layout .....	5
4	Schematic and Bill of Materials .....	8
	4.1 Schematic .....	8
	4.2 Bill of Materials .....	9

## List of Figures

1	DIV Jumper Settings.....	2
2	ENA Jumper Settings.....	2
3	ENB Jumper Settings.....	3
4	ENC Jumper Settings .....	3
5	SYNC Jumper Setting .....	3
6	RT Jumper Setting .....	3
7	EXTSUP Jumper Setting.....	4
8	Top Assembly Layer .....	6
9	Top Layer Routing .....	6
10	Bottom Assembly Layer .....	7
11	Bottom Layer Routing .....	7
12	TPS4333xEVM Schematic.....	8

## List of Tables

1	Device and Package Configurations .....	2
2	TPS4333xEVM Bill of Materials.....	9

## 1 Introduction

The Texas Instruments TPS4333xEVM evaluation module (EVM) helps designers evaluate the operation and performance of the TPS4333x family of Switch Mode Power Supplies – Multiple-output voltage regulator.

The EVM contains one DC / DC converter (see [Table 1](#)).

**Table 1. Device and Package Configurations**

Converter	IC	Package
U1	TPS43330QDAPQ1	DAP-38
	TPS43332QDAPQ1	
	TPS43335QDAPQ1	
	TPS43336QDAPQ1	

## 2 Setup

This section describes the jumpers and connectors on the EVM as well and how to properly connect, set up and use the TPS4333xEVM.

### 2.1 Input/Output Connector Description

**J1 – Input** is the protected power input terminal for the converter with a voltage range from 2V-40V (Boost enabled) or 4V-40V (Boost disabled). The terminal block provides a power ( $V_{bat}$ ) and ground (GND) connection to allow the user to attach the EVM to a cable. harness. The power path provides a series Schottky diode for reverse battery protection.

**J2 – VOUTA** is the output terminal for the TPS4333x buck controller A. The terminal block provides a power (VOUTA) and ground (GND) connection.

**J3 – VOUTB** is the output terminal for the TPS4333x buck controller B. The terminal block provides a power (VOUTB) and ground (GND) connection.

**JP1 – DIV** is the jumper used to select the output voltage for the boost pre-regulator stage. The boost output is 7V when DIV is low, 10V when DIV floating and 11V when DIV is pulled high.

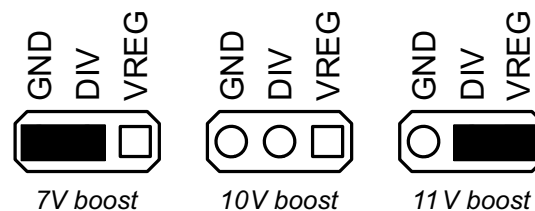

**Figure 1. DIV Jumper Settings**

**JP2 – ENA** is the jumper used to enable buck controller A. The controller will be enabled when the ENA is high and disabled when low.

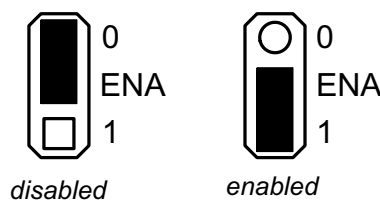

**Figure 2. ENA Jumper Settings**

**JP3 – ENB** is the jumper used to enable buck controller B. The controller will be enabled when the ENB is high and disabled when low.

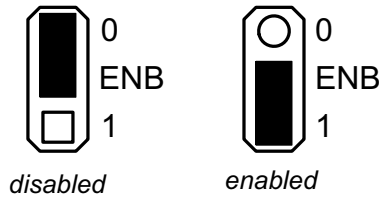

**Figure 3. ENB Jumper Settings**

**JP3 – ENC** is the jumper used to enable the boost pre-regulator. The converter will be enabled when the ENC is high and disabled when low.

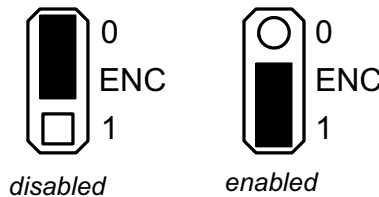

**Figure 4. ENC Jumper Settings**

**JP4 – SYNC** is the external clock input for switching frequency synchronization of the buck converters and to enable Low Power Mode (LPM). The external clock source can be attached to the center pin of JP4. A high logic level on this pin ensures forced continuous mode operation of the buck controllers and inhibits transition to low power mode. An open or low allows discontinuous mode operation, and entry into low power mode at light loads. On the TPS43332 and TPS43336, a high level enables frequency-hopping spread spectrum while an open or a low level disables the spectrum.

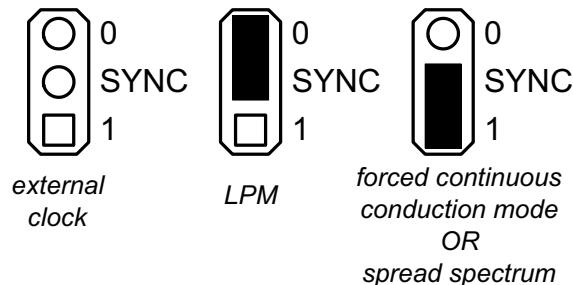

**Figure 5. SYNC Jumper Setting**

**JP5 – RT** is the jumper used to choose the switching frequency of the Buck controllers. The operating frequency can be set to 240 KHz, 400 KHz or 600 KHz.

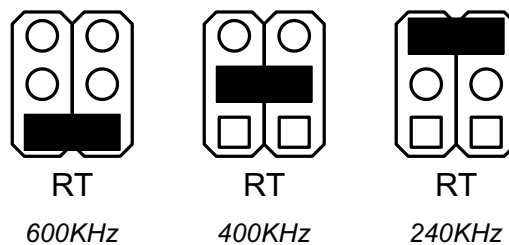

**Figure 6. RT Jumper Setting**

**JP6 – EXTSUP** is the jumper used to choose one of the Buck output voltages (VOUTA or VOUTB) to provide the internal voltage VREG. If no jumper is plugged, VREG is generated from the input voltage.

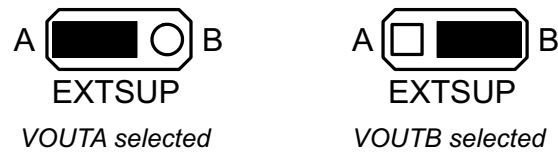

**Figure 7. EXTSUP Jumper Setting**

### Test Points

• DLYAB	Power Good Delay for Buck Controller A and B
• DS	Drain-Source Current Sense for Boost FET
• GND (x4)	Ground
• PGA	Power Good for Buck Controller A
• PGB	Power Good for Buck Controller B
• PHA	Buck Controller A phase pin
• PHB	Buck Controller B phase pin
• SSA	Soft Start for Buck Controller A
• SSB	Soft Start for Buck Controller B
• VBAT	Power Input before the boost regulator stage
• VIN	Power Input after the boost regulator stage
• VOUTA	Buck Controller A output
• VOUTB	Buck Controller B output

## 2.2 Setup

The input voltage range for the converter is 2 V to 40 V. A load should be applied to the output terminal for proper operation.

### 2.3 Operation

For proper operation of the TPS43330, DIV, ENA, ENB, ENC, EXTSUP, JP5 (OSC) and SYNC jumpers should be properly configured. The recommended setting, using the switch and shorting blocks.

DIV	VREG
ENA	enabled
ENB	enabled
ENC	enabled
EXTSUP	A
RT	400KHz
SYNC	LPM

In this configuration, the regulators will turn on when power is applied. DIV selects the output voltage for the Boost pre-regulator stage. ENA, ENB and ENC turn the regulators on or off, disabled or enabled. EXTSUP selects the power supply source for the gate drive. RT sets the switching frequency for the regulators to approximately 240KHz, 400KHz or 600KHz. SYNC enabled LPM or forced continuous conduction mode and is the external clock input for switching frequency synchronization of the buck converters. SYNC will disable spread spectrum operation on the TPS43332 and TPS43336 when set low or left open. The device can be setup to run in low power mode, to reduce the quiescent operating current, by connecting the Sync test point to ground. Low power mode will allow the device to switch into a PFM mode of operation if the load current demand is low. It will automatically switch back to PWM mode as the load current increases.

Regulator	Output Voltage	Maximum Output Current
Buck Controller A:	5 V	2A
Buck Controller B:	3.3 V	4A

If jitter is observed on the phase signal of the regulator, then noise may be entering the feedback interface and a capacitive filter may be required. The EVM provides a footprint across the low-side feedback resistors to add these capacitors, if needed. A capacitor has been added across the low-side resistor on the EVM. Typically 47pF to 100pF is sufficient to filter any noise issues.

### 3 Board Layout

[Figure 8](#), through [Figure 11](#) show the board layout for the TPS43330EVM PWB.

The TPS43330 controller offers high efficiency, but does dissipate power. The PowerPAD™ package offers an exposed thermal pad to enhance thermal performance. This must be soldered to the copper landing on the PCB for optimal performance. The PCB provides 2 oz copper planes on the top and bottom to dissipate heat

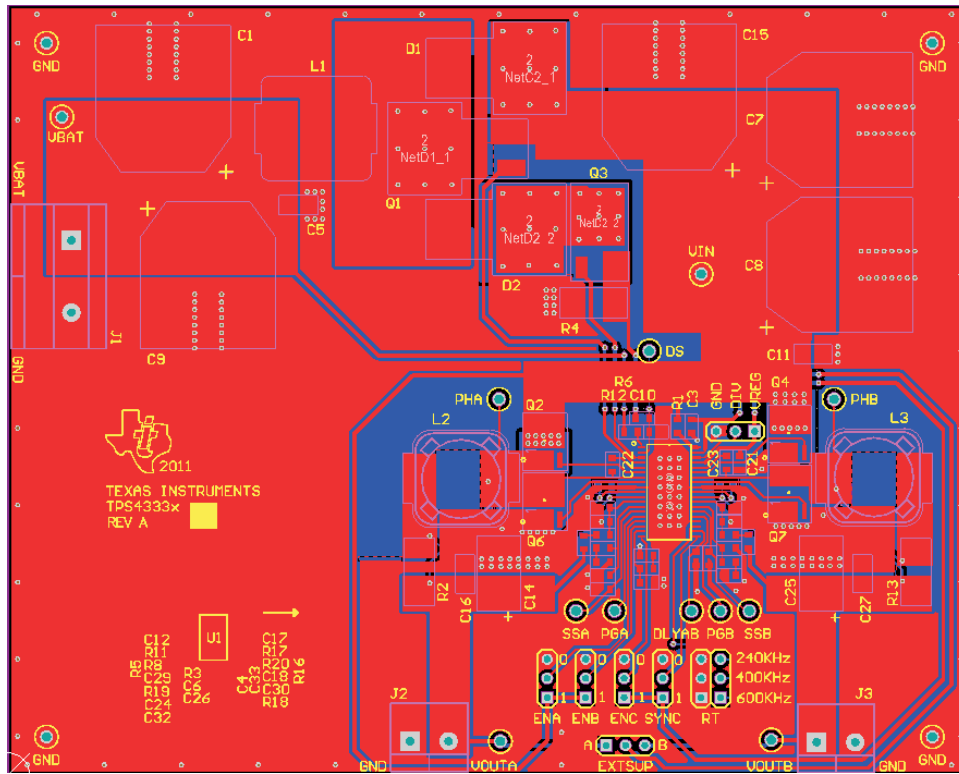

Figure 8. Top Assembly Layer

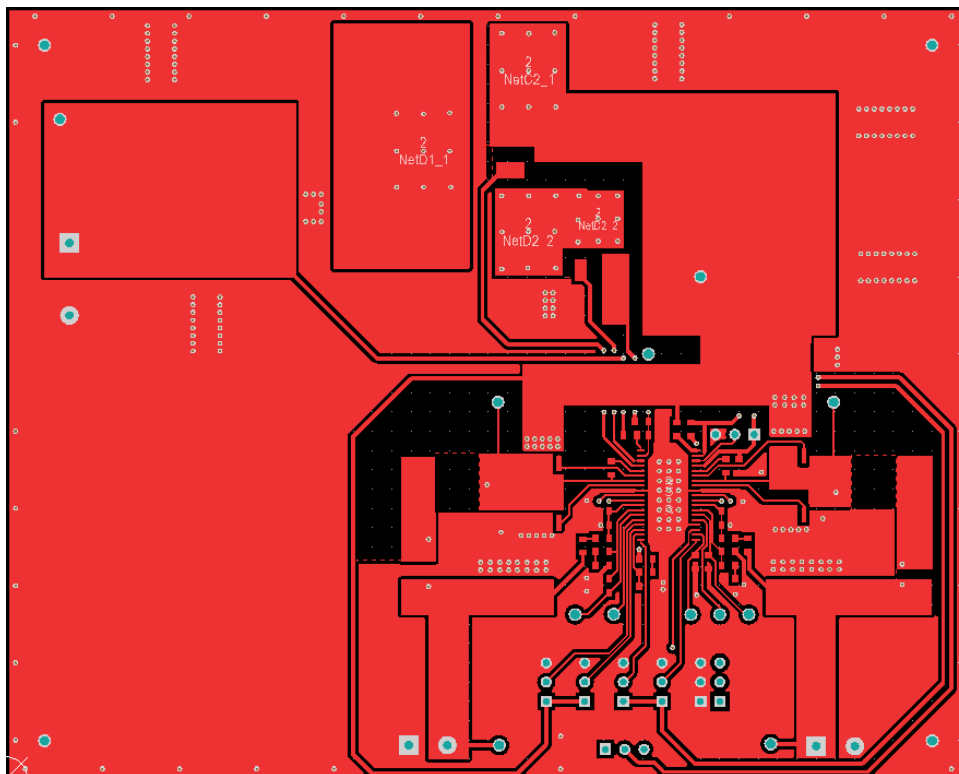

Figure 9. Top Layer Routing

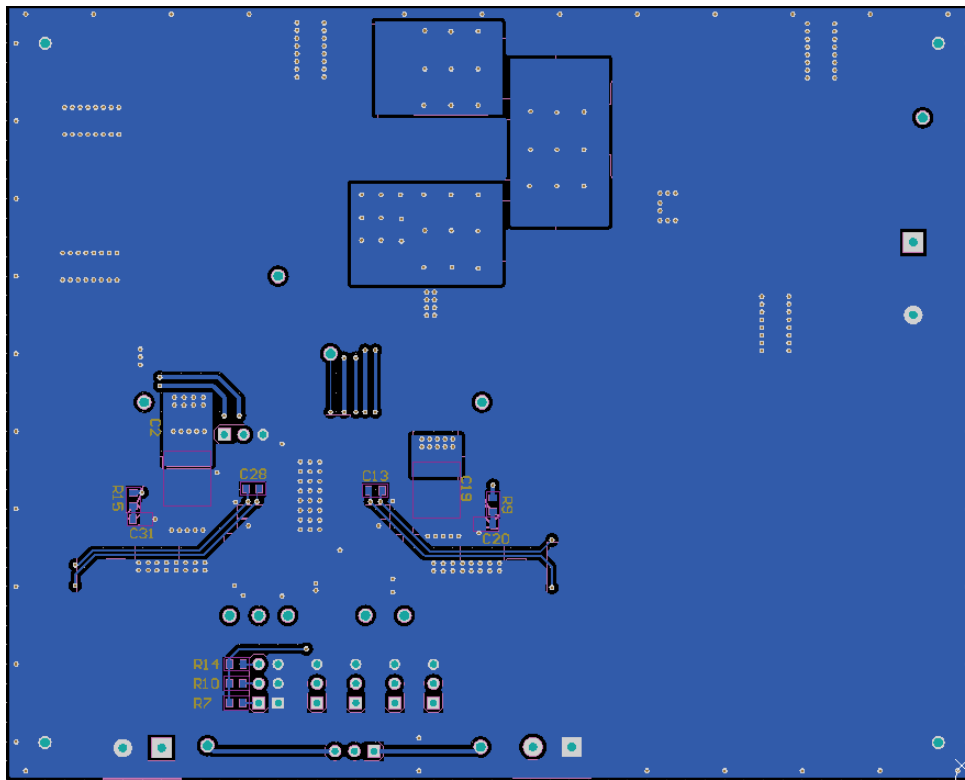

Figure 10. Bottom Assembly Layer

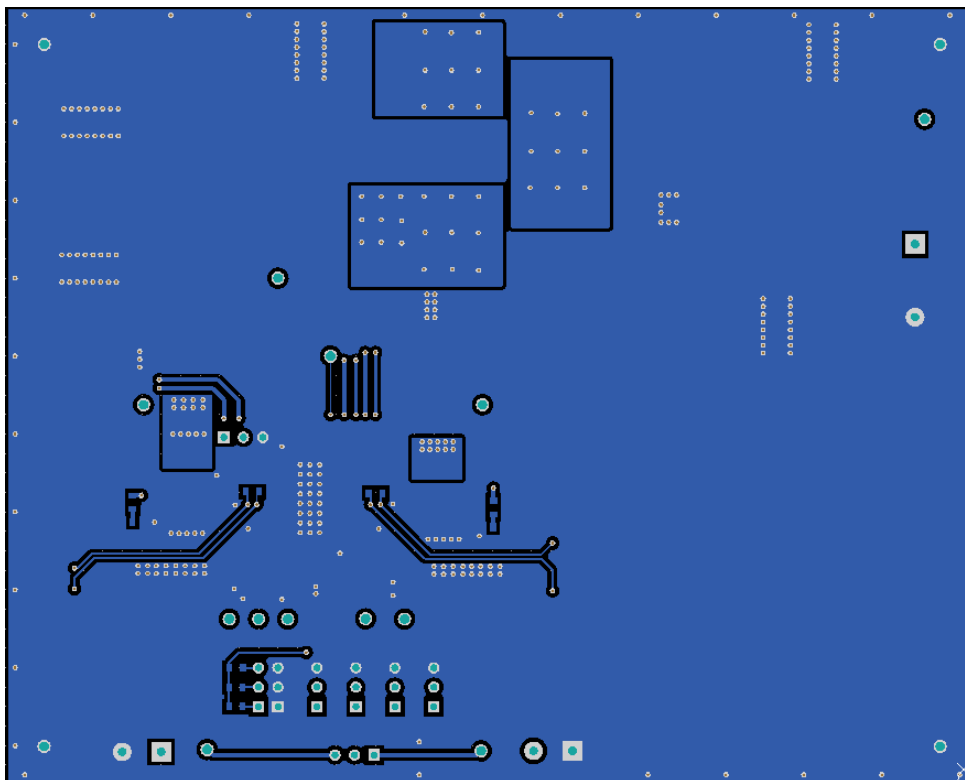

Figure 11. Bottom Layer Routing

## 4 Schematic and Bill of Materials

### 4.1 Schematic

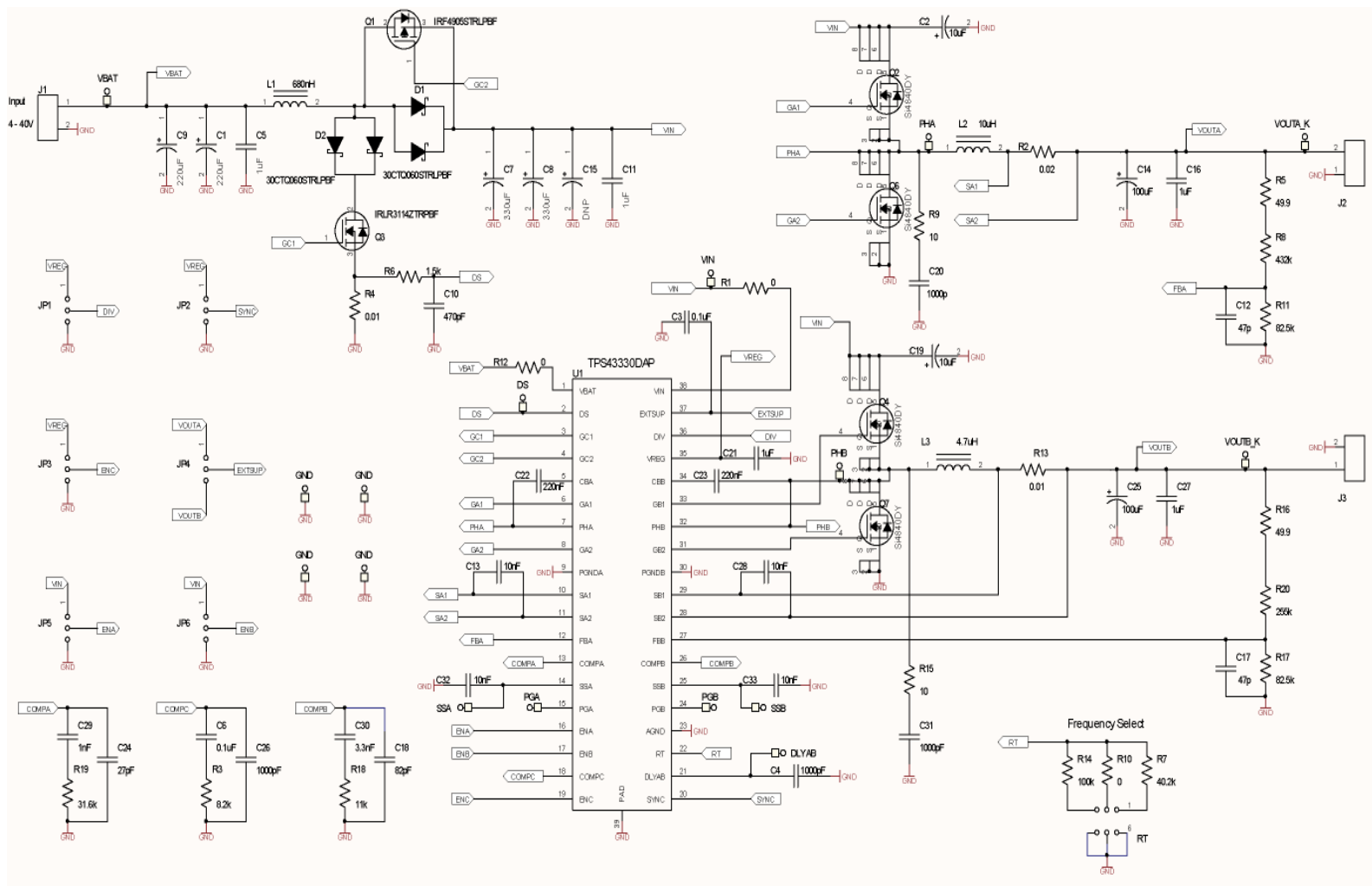

Figure 12. TPS4333xEVM Schematic



## 4.2 Bill of Materials

**Table 2. TPS4333xEVM Bill of Materials**

COUNT	REF DES	DESCRIPTION	SIZE	MFR	PART NUMBER
2	C1, C9	Capacitor, electrolytic, 220uF, 50V, 20%	G	Panasonic	EEE-FK1H221P
2	C2, C19	Capacitor, ceramic, 10uF, 50V, 10%	2220	TDK	C5750X7R1H106M
2	C3, C6	Capacitor, ceramic, 0.1uF, 50V, 10%	603	Std	Std
5	C4, C20, C26, C29, C31	Capacitor, ceramic, 1000pF, 50V, 10%	603	Std	Std
2	C5, C11	Capacitor, ceramic, 1uF, 100V, 10%	1206	Std	Std
2	C7, C8	Capacitor, electrolytic, 330uF, 50V, 20%	H13	Panasonic	EEV-FK1H331Q
1	C10	Capacitor, ceramic, 470pF, 50V, 10%	603	Std	Std
2	C12, C17	Capacitor, ceramic, 47pF, 50V, 10%	603	Std	Std
4	C13, C28, C32, C33	Capacitor, ceramic, 0.01uF, 50V, 10%	603	Std	Std
2	C14, C25	Capacitor, tantalum, 100uF, 16V, 10%	7343	AVX	TPSD107K016R0060
1	C15	Do not populate			
3	C16, C21, C27	Capacitor, ceramic, 1uF, 16V, 10%	603	Std	Std
1	C18	Capacitor, ceramic, 82pF, 50V, 10%	603	Std	Std
2	C22, C23	Capacitor, ceramic, 220nF, 50V, 10%	603	Std	Std
1	C24	Capacitor, ceramic, 27pF, 50V, 10%	603	Std	Std
1	C30	Capacitor, ceramic, 3.3nF, 50V, 10%	603	Std	Std
2	D1, D2	Diode, Schottky, 15A, 60V	D2PAK	Vishay	30CTQ060STRLPBF
1	J1	Terminal block, 2-pin, 25A	9.52MM	OST	OSTT7022150
2	J2, J3	Terminal block, 2-pin, 15A	2 x 5.1mm	OST	OSTTA024163
6	JP1, JP2, JP3, JP4, JP5, JP6	Header, 3-pin, 100-mil spacing	0.100 x 3	Sullins	PEC03SAAN
1	RT	Header, 6-pin, 100-mil spacing	0.100 x 3	Sullins	PEC06DAAN
7	JP1, JP2, JP3, JP4, JP5, JP6, RT	Connector jumper, shorting, 100-mil spacing	0.1	Sullins	SPC02SYAN
1	L1	Inductor, SMT, 0.68uH, 28A	13.2mm x 12.9mm	Vishay	IHLP5050CEERR68M01
1	L2	Inductor, SMT, 10-uH, 6.04A	12.3mm x 12.3mm	Coilcraft	MSS1278T-103ML
1	L3	Inductor, SMT, 4.7-uH, 4.3A	12.3mm x 12.3mm	Coilcraft	MSS1278T-472ML
1	Q1	MOSFET P-CH 55V 42A	D2PAK	IR	IRF4905STRLPBF
4	Q2, Q4, Q6, Q7	MOSFET, n-channel	SOIC	Vishay	SI4840DY
1	Q3	MOSFET, n-channel	DPAK	IR	IRLR3114ZTRPBF
3	R1, R10, R12	Resistor, chip, 0-ohms, 1/16W, 5%	603	Std	Std

**Table 2. TPS4333xEVM Bill of Materials (continued)**

COUNT	REF DES	DESCRIPTION	SIZE	MFR	PART NUMBER
1	R2	Resistor, chip, 0.02-ohm, 2W	2512	Stackpole	CSRN2512FK20L0
1	R3	Resistor, chip, 8.2-kohms, 1/16W, 1%	603	Std	Std
2	R4, R13	Resistor, chip, 0.01-ohm, 2W	2512	Stackpole	CSRN2512FK10L0
2	R5, R16	Resistor, chip, 49.9-ohms, 1/16W, 1%	603	Std	Std
1	R6	Resistor, chip, 1.5-kohms, 1/16W, 1%	603	Std	Std
1	R7	Resistor, chip, 40.2-kohms, 1/16W, 1%	603	Std	Std
1	R8	Resistor, chip, 432-kohms, 1/16W, 1%	603	Std	Std
2	R9, R15	Resistor, chip, 10-ohms, 1/16W, 1%	603	Std	Std
2	R11, R17	Resistor, chip, 82.5-kohms, 1/16W, 1%	603	Std	Std
1	R14	Resistor, chip, 100-kohms, 1/16W, 1%	603	Std	Std
1	R18	Resistor, chip, 11-kohms, 1/16W, 1%	603	Std	Std
1	R19	Resistor, chip, 31.6-kohms, 1/16W, 1%	603	Std	Std
1	R20	Resistor, chip, 255-kohms, 1/16W, 1%	603	Std	Std
16	DLYAB, DS, GND (x4), PGA, PGB, PHA, PHB, SSA, SSB, VBAT, VIN, VOUTA_K, VOUTB_K	Test point, 52-mil	0.052	Std	Std
1	U1	IC, TPS43330DAPRQ1 or TPS43332DAPRQ1 or TPS43335DAPRQ1 or TPS43336DAPRQ1		TI	TPS43330-Q1 or TPS43332-Q1 or TPS43335-Q1 or TPS43336-Q1
	-	PCB, 5-inch x 4-inch x 0.062		Any	TPS4333X, REV A

## Evaluation Board/Kit Important Notice

Texas Instruments (TI) provides the enclosed product(s) under the following conditions:

This evaluation board/kit is intended for use for **ENGINEERING DEVELOPMENT, DEMONSTRATION, OR EVALUATION PURPOSES ONLY** and is not considered by TI to be a finished end-product fit for general consumer use. Persons handling the product(s) must have electronics training and observe good engineering practice standards. As such, the goods being provided are not intended to be complete in terms of required design-, marketing-, and/or manufacturing-related protective considerations, including product safety and environmental measures typically found in end products that incorporate such semiconductor components or circuit boards. This evaluation board/kit does not fall within the scope of the European Union directives regarding electromagnetic compatibility, restricted substances (RoHS), recycling (WEEE), FCC, CE or UL, and therefore may not meet the technical requirements of these directives or other related directives.

Should this evaluation board/kit not meet the specifications indicated in the User's Guide, the board/kit may be returned within 30 days from the date of delivery for a full refund. **THE FOREGOING WARRANTY IS THE EXCLUSIVE WARRANTY MADE BY SELLER TO BUYER AND IS IN LIEU OF ALL OTHER WARRANTIES, EXPRESSED, IMPLIED, OR STATUTORY, INCLUDING ANY WARRANTY OF MERCHANTABILITY OR FITNESS FOR ANY PARTICULAR PURPOSE.**

The user assumes all responsibility and liability for proper and safe handling of the goods. Further, the user indemnifies TI from all claims arising from the handling or use of the goods. Due to the open construction of the product, it is the user's responsibility to take any and all appropriate precautions with regard to electrostatic discharge.

**EXCEPT TO THE EXTENT OF THE INDEMNITY SET FORTH ABOVE, NEITHER PARTY SHALL BE LIABLE TO THE OTHER FOR ANY INDIRECT, SPECIAL, INCIDENTAL, OR CONSEQUENTIAL DAMAGES.**

TI currently deals with a variety of customers for products, and therefore our arrangement with the user **is not exclusive.**

TI assumes **no liability for applications assistance, customer product design, software performance, or infringement of patents or services described herein.**

Please read the User's Guide and, specifically, the Warnings and Restrictions notice in the User's Guide prior to handling the product. This notice contains important safety information about temperatures and voltages. For additional information on TI's environmental and/or safety programs, please contact the TI application engineer or visit [www.ti.com/esh](http://www.ti.com/esh).

No license is granted under any patent right or other intellectual property right of TI covering or relating to any machine, process, or combination in which such TI products or services might be or are used.

## FCC Warning

This evaluation board/kit is intended for use for **ENGINEERING DEVELOPMENT, DEMONSTRATION, OR EVALUATION PURPOSES ONLY** and is not considered by TI to be a finished end-product fit for general consumer use. It generates, uses, and can radiate radio frequency energy and has not been tested for compliance with the limits of computing devices pursuant to part 15 of FCC rules, which are designed to provide reasonable protection against radio frequency interference. Operation of this equipment in other environments may cause interference with radio communications, in which case the user at his own expense will be required to take whatever measures may be required to correct this interference.

## EVM Warnings and Restrictions

It is important to operate this EVM within the input voltage range of 2 V to 40 V (Boost enabled) or 4V to 40 V (Boost disabled) and the output voltage range of 9 V to 11 V .

Exceeding the specified input range may cause unexpected operation and/or irreversible damage to the EVM. If there are questions concerning the input range, please contact a TI field representative prior to connecting the input power.

Applying loads outside of the specified output range may result in unintended operation and/or possible permanent damage to the EVM. Please consult the EVM User's Guide prior to connecting any load to the EVM output. If there is uncertainty as to the load specification, please contact a TI field representative.

During normal operation, some circuit components may have case temperatures greater than 85°C. The EVM is designed to operate properly with certain components above 60°C as long as the input and output ranges are maintained. These components include but are not limited to linear regulators, switching transistors, pass transistors, and current sense resistors. These types of devices can be identified using the EVM schematic located in the EVM User's Guide. When placing measurement probes near these devices during operation, please be aware that these devices may be very warm to the touch.

Mailing Address: Texas Instruments, Post Office Box 655303, Dallas, Texas 75265  
Copyright © 2011, Texas Instruments Incorporated

## IMPORTANT NOTICE

Texas Instruments Incorporated and its subsidiaries (TI) reserve the right to make corrections, modifications, enhancements, improvements, and other changes to its products and services at any time and to discontinue any product or service without notice. Customers should obtain the latest relevant information before placing orders and should verify that such information is current and complete. All products are sold subject to TI's terms and conditions of sale supplied at the time of order acknowledgment.

TI warrants performance of its hardware products to the specifications applicable at the time of sale in accordance with TI's standard warranty. Testing and other quality control techniques are used to the extent TI deems necessary to support this warranty. Except where mandated by government requirements, testing of all parameters of each product is not necessarily performed.

TI assumes no liability for applications assistance or customer product design. Customers are responsible for their products and applications using TI components. To minimize the risks associated with customer products and applications, customers should provide adequate design and operating safeguards.

TI does not warrant or represent that any license, either express or implied, is granted under any TI patent right, copyright, mask work right, or other TI intellectual property right relating to any combination, machine, or process in which TI products or services are used. Information published by TI regarding third-party products or services does not constitute a license from TI to use such products or services or a warranty or endorsement thereof. Use of such information may require a license from a third party under the patents or other intellectual property of the third party, or a license from TI under the patents or other intellectual property of TI.

Reproduction of TI information in TI data books or data sheets is permissible only if reproduction is without alteration and is accompanied by all associated warranties, conditions, limitations, and notices. Reproduction of this information with alteration is an unfair and deceptive business practice. TI is not responsible or liable for such altered documentation. Information of third parties may be subject to additional restrictions.

Resale of TI products or services with statements different from or beyond the parameters stated by TI for that product or service voids all express and any implied warranties for the associated TI product or service and is an unfair and deceptive business practice. TI is not responsible or liable for any such statements.

TI products are not authorized for use in safety-critical applications (such as life support) where a failure of the TI product would reasonably be expected to cause severe personal injury or death, unless officers of the parties have executed an agreement specifically governing such use. Buyers represent that they have all necessary expertise in the safety and regulatory ramifications of their applications, and acknowledge and agree that they are solely responsible for all legal, regulatory and safety-related requirements concerning their products and any use of TI products in such safety-critical applications, notwithstanding any applications-related information or support that may be provided by TI. Further, Buyers must fully indemnify TI and its representatives against any damages arising out of the use of TI products in such safety-critical applications.

TI products are neither designed nor intended for use in military/aerospace applications or environments unless the TI products are specifically designated by TI as military-grade or "enhanced plastic." Only products designated by TI as military-grade meet military specifications. Buyers acknowledge and agree that any such use of TI products which TI has not designated as military-grade is solely at the Buyer's risk, and that they are solely responsible for compliance with all legal and regulatory requirements in connection with such use.

TI products are neither designed nor intended for use in automotive applications or environments unless the specific TI products are designated by TI as compliant with ISO/TS 16949 requirements. Buyers acknowledge and agree that, if they use any non-designated products in automotive applications, TI will not be responsible for any failure to meet such requirements.

Following are URLs where you can obtain information on other Texas Instruments products and application solutions:

### Products

Audio	<a href="http://www.ti.com/audio">www.ti.com/audio</a>
Amplifiers	<a href="http://amplifier.ti.com">amplifier.ti.com</a>
Data Converters	<a href="http://dataconverter.ti.com">dataconverter.ti.com</a>
DLP® Products	<a href="http://www.dlp.com">www.dlp.com</a>
DSP	<a href="http://dsp.ti.com">dsp.ti.com</a>
Clocks and Timers	<a href="http://www.ti.com/clocks">www.ti.com/clocks</a>
Interface	<a href="http://interface.ti.com">interface.ti.com</a>
Logic	<a href="http://logic.ti.com">logic.ti.com</a>
Power Mgmt	<a href="http://power.ti.com">power.ti.com</a>
Microcontrollers	<a href="http://microcontroller.ti.com">microcontroller.ti.com</a>
RFID	<a href="http://www.ti-rfid.com">www.ti-rfid.com</a>
RF/IF and ZigBee® Solutions	<a href="http://www.ti.com/lprf">www.ti.com/lprf</a>

### Applications

Communications and Telecom	<a href="http://www.ti.com/communications">www.ti.com/communications</a>
Computers and Peripherals	<a href="http://www.ti.com/computers">www.ti.com/computers</a>
Consumer Electronics	<a href="http://www.ti.com/consumer-apps">www.ti.com/consumer-apps</a>
Energy and Lighting	<a href="http://www.ti.com/energy">www.ti.com/energy</a>
Industrial	<a href="http://www.ti.com/industrial">www.ti.com/industrial</a>
Medical	<a href="http://www.ti.com/medical">www.ti.com/medical</a>
Security	<a href="http://www.ti.com/security">www.ti.com/security</a>
Space, Avionics and Defense	<a href="http://www.ti.com/space-avionics-defense">www.ti.com/space-avionics-defense</a>
Transportation and Automotive	<a href="http://www.ti.com/automotive">www.ti.com/automotive</a>
Video and Imaging	<a href="http://www.ti.com/video">www.ti.com/video</a>
Wireless	<a href="http://www.ti.com/wireless-apps">www.ti.com/wireless-apps</a>

TI E2E Community Home Page

[e2e.ti.com](http://e2e.ti.com)

Mailing Address: Texas Instruments, Post Office Box 655303, Dallas, Texas 75265  
Copyright © 2011, Texas Instruments Incorporated