

F210 Vision Sensor



Advanced machine vision capability for high-speed, two-camera applications in a compact package

Advanced Visual Inspection Performance for Today's Demanding Applications

Omron's F210 vision sensor delivers high-performance vision analysis using industry-leading inspection and location algorithms combined with high-speed one- or two-camera capability. Omron's F210 setup software uses a flexible, easy-to-load tool set and flow-chart style drop down menu system to simplify configuring the inspection process. Compared to PC-based vision solutions, F210 provides a lower-cost integrated and compact, advanced high-speed industrial machine vision solution for complex quality, motion and process control applications.

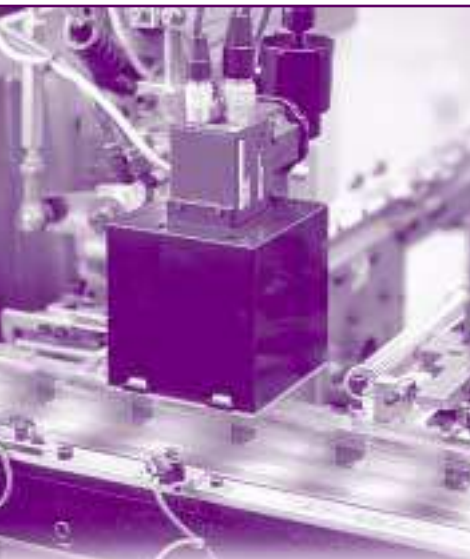

Advanced Algorithms

Edge Code (EC) Positioning

High-precision positioning and low-contrast workpiece detection



QUEST Character Recognition

Confirm expiration dates and lot numbers using the OCR/OCV algorithm



Edge Code (EC) Defect Inspection

Inspection for fine scratches, dirt, and deformation



Fine Matching

Inspection of characters and graphic patterns for blurring or dirt



Omron's advanced technology and know-how give you the productivity edge:

- Edge Code Technology adds enhanced and ultra-precise detection performance to many of the F210's commonly used algorithms. For example, defect inspection can detect fine scratches, dirt and deformities, as well as acquire high-precision position detection.
- Omron's original QUEST Optical Character Recognition and Verification algorithm uses built-in character libraries and can discern multiple characters simultaneously. QUEST also enhances the detection of printed alphanumeric characters regardless of their shape or size without additional teaching.

Fast Image Input

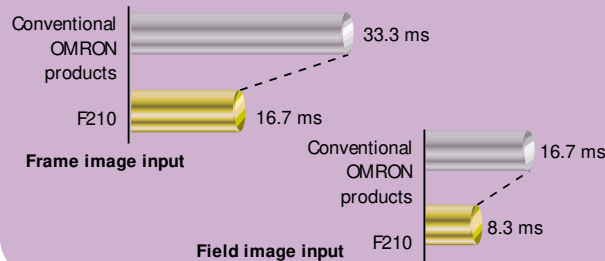

Fast Image Processing

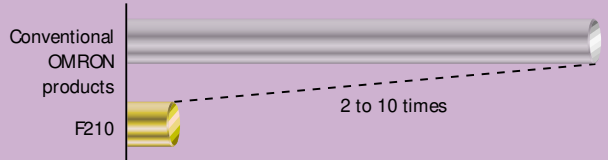

Flow Chart Menu System

The flow chart style drop-down menu system lets you select the required processing items from a library then combines and links them for you.

- Stabilize measurement images by filtering the required number of times.
- Perform measurements according to workpiece tolerance by changing the measurement area based on measurement results.

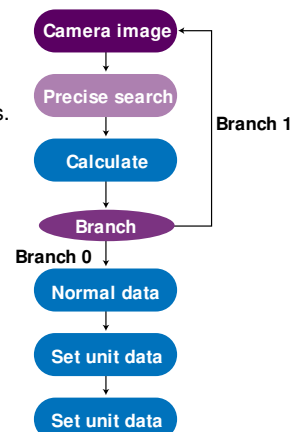
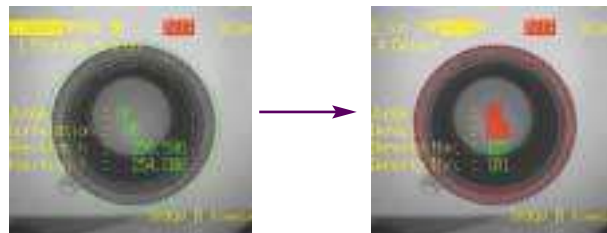

High-Speed Measurement and Inspection Applications



Product Sorting

Sort multiple product by size or labels and inspect for quality.

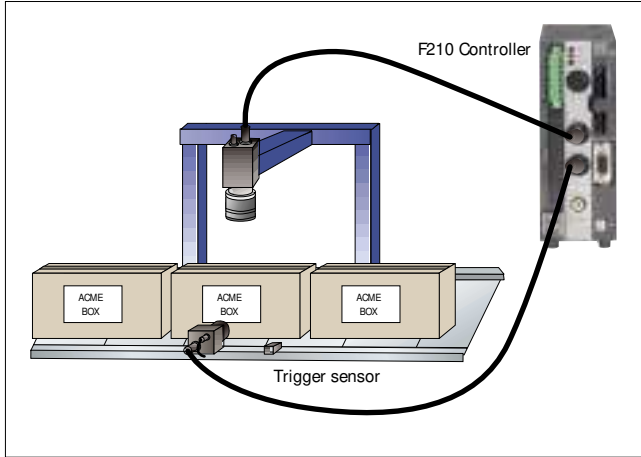

High-Speed Detection/Counting

Detect missing parts and count high quantity part lots.

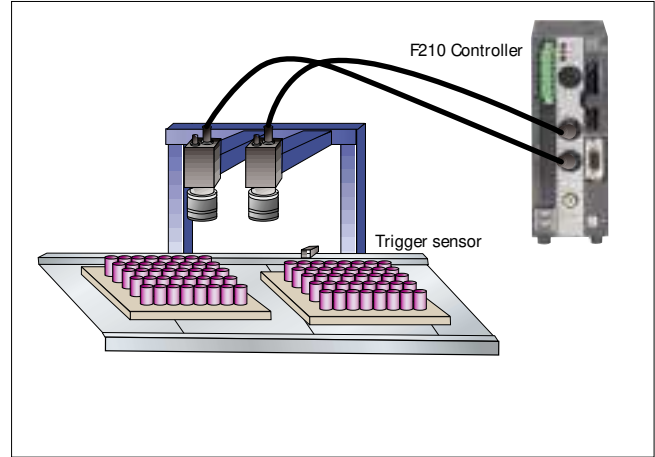

High-Speed Part Gauging

Gauge object lengths, diameters and feature locations on assemblies.

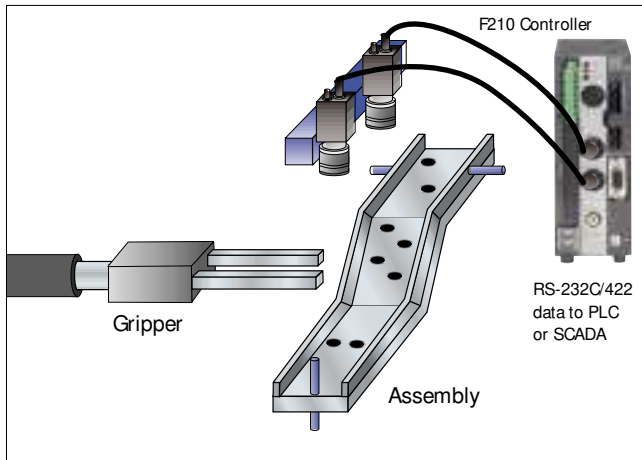

High-Speed Electronics Inspection

Electronic component inspection/board position measurement.

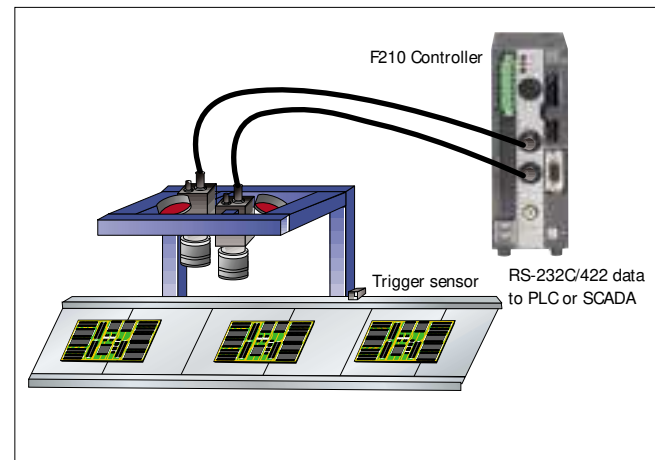

OCR and Packaging Inspection

Seal presence/absence and label defect, lot/date confirmation.

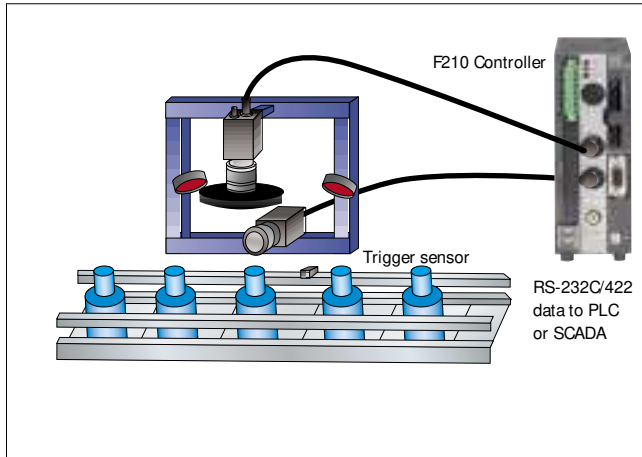

High-Speed Robotic Tool Guidance

Report tool and part alignment/position and monitor tooling wear.

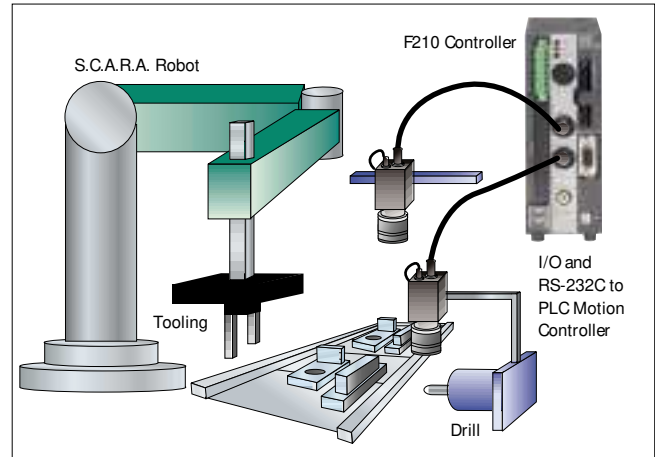

Advanced Algorithms

Edge Code (EC) Technology

Edge Code Technology's advanced inspection and positioning algorithms use the direction of changes in brightness and the differences in image brightness to achieve ultra-precise detection. EC technology also enables the detection of low-contrast images and deformed or partly defective parts or features to a degree that was never before possible.

EC Positioning

The F210 performs positioning and measurement accurately even if the workpiece internally changes or its appearance viewed from the sensor changes.



Positioning of PCB's Fiducial Marks



Low-contrast



Rotation



Internal dirt

EC Defect Inspection



Accurately detects fine defects that could not be detected before, even on edges of parts.



Correctly detects distortion or deformation in rubber packing, etc.



Detects scratches on metal surfaces, even with low-contrast images.

Fine Matching

The F210 quickly and accurately detects any differences between the registered model and the image being measured. This dramatically improved model matching algorithm now reveals fine defects on the edges of characters, printed labels and graphic patterns that may have gone undetected in the past using less accurate matching algorithms.



Registered image



Inspected image

Fine Matching

Application example: inspection for soft drink bottle caps

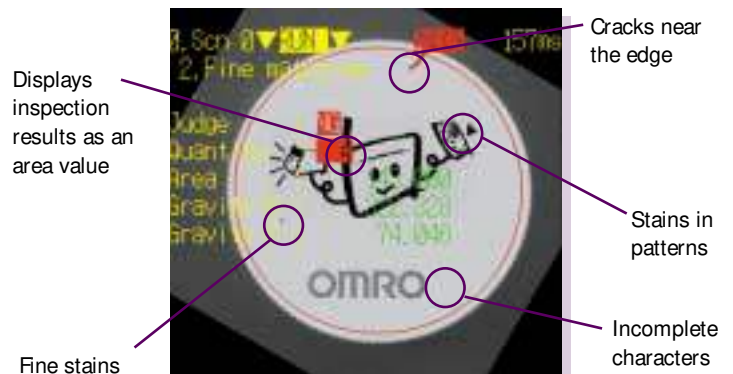

Advanced Algorithms

QUEST Optical Character Recognition

QUEST technology can recognize characters correctly, regardless of their size or shape. Using built-in character libraries makes setup easy with no character teaching required.

Correctly Recognizes Six Different Types of Character Variations

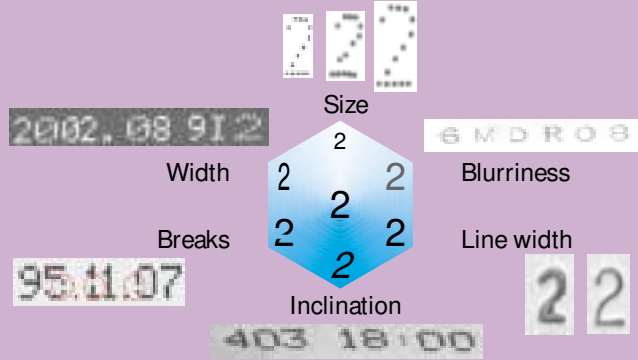

Printed characters such as expiration dates, lot numbers and date codes can vary in shape, size and line width based on the printing method and conditions. The QUEST algorithm ensures that the six most common types of variations are always recognized correctly.

QUEST technology has built-in character libraries of commonly used factory automation fonts stored for ready reference. This eliminates the need to register characters as models, or teach and create font or character libraries to handle most text. Setup time during installation is greatly reduced.

No Need to Register Characters in a Library

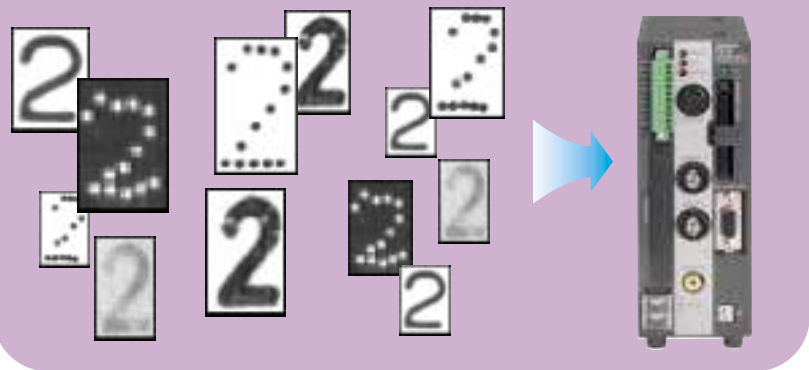

Advanced Productivity Tool

Trend Monitor Function

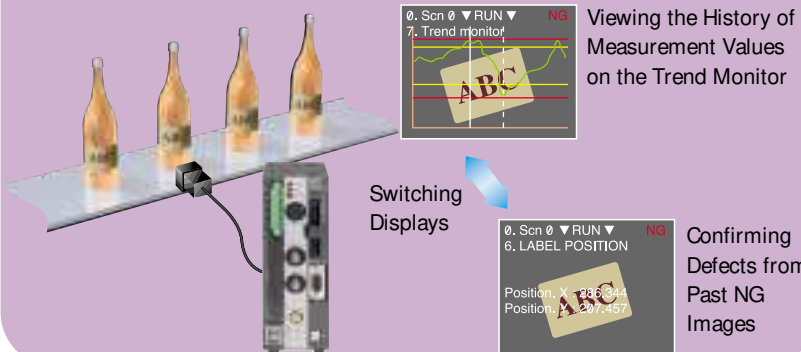

Use the Trend Monitor to view measurement values and judgment results. They can be trended and displayed on the monitor while in operation, allowing easy monitoring of the application during setup, online operation or troubleshooting. The NG Image Save function can be useful for solving the cause of rejects by providing visual confirmation with the NG image when they occur. The Judgment Results Limits can also be adjusted while watching the trend monitor, simplifying setup and adjustment.

System Configuration

F160 Double-Speed Cameras

Cameras with Intelligent Lighting
F160-SLC20
F160-SLC50

Camera F160-S1



F150 Cameras

Cameras with Intelligent Lighting
F150-SLC20
F150-SLC50

Cameras with Light Source
F150-SL20A
F150-SL50A

Camera F150-S1A



* The F300-S2R, F300-S3DR, and F300-S Cameras are also compatible

Parallel Cable F160-VP

Synchronous Sensor

Programmable Controller

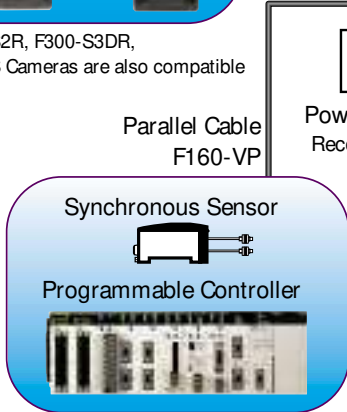

Camera Cable F150-VS

Controller F210-C10/C15

Console F160-KP



Memory Card F160-N64S
F250-UM3FE (Flow Menu Format)
Application Software

Monitor

Color LCD Monitor F150-M05L



Power Supply
Recommended model:
OMRON S8TS

Monitor Cable
RCA/BNC
Video Cable

RS-232C/422

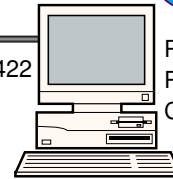

PLC or
Personal
Computer

Dimensions mm (inches)

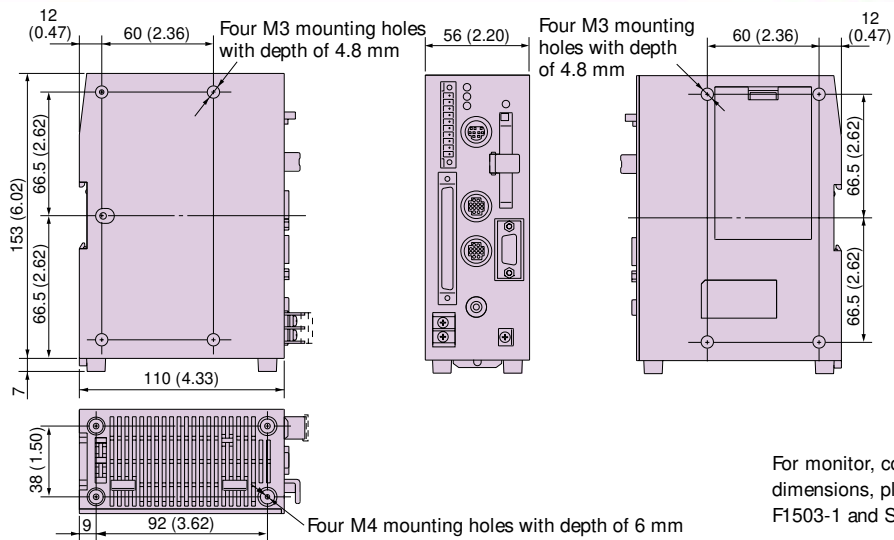

For monitor, console, or camera dimensions, please refer to SB F1503-1 and SB F160-1 brochures.

Specifications



Item	F210-C10/C15
Connectable cameras	F150-S1A/-SL20A/-SL50A/-SLC20/-SLC50, F160-S1/-S2/-SLC20/-SLC50, F300-S2R/-S3DR, etc.
Number of cameras connectable	2
Number of pixels	512 H x 484 V
Number of scenes	32 (Expansion possible using memory cards)
Image storage function	Maximum of 35 images stored
Filtering	Smoothing (strong, weak), edge enhancement, edge extraction (horizontal, vertical, both) dilation, erosion, median, background suppression
Operation and settings	Installing measurement items using application software, and combining and setting measurement items by menu operations
Menu language	Japanese or English (can be switched)
Trend monitor function	Supported
Memory card slots	1
Monitor interface	1 channel
Serial communications	RS-232C/422A: 1 channel
Parallel I/O	13 inputs and 22 outputs
Strobe interface	2 channels (included in parallel outputs)
Power supply voltage	20.4 to 26.4 VDC
Current consumption	Approx. 1.6 A (when two F160-SLC50 cameras are connected)
Ambient temperature	Operating: 0 to 50°C; Storage: -25 to 65°C (with no icing or condensation)
Ambient humidity	Operating and storage: 35% to 85% (with no condensation)
External dimensions	56 W x 160 H x 110 D mm (not including connectors and other protruding parts)
Weight	Approx. 570 g (controller only)

Ordering Information



- First:** Start by selecting the controller part number with the correct input/output type, NPN or PNP, and application software for first time installations to meet the applications needs.
- Second:** Choose cameras for the system. Omron offers three F160 double-speed or five standard speed F150 cameras. Select one to four cameras based on the application. Cameras with built-in Intelligent Light Source are available for 20- or 50-mm fields of vision in both the F150 and F160 series. If a different field of vision and lighting is required, use the F150-S1A or F160-S1 camera without lens and light source. **Important: cameras from the F150, F160 and F300 series CANNOT be mixed on a single controller.** **Note:** F150 camera distance setting information is in vision sensor brochure SB F1503-1; F160 camera distance setting information is in brochure SB F160-1.
- Third:** Choose camera cables, Parallel I/O cable, monitor, monitor cable as required. For additional camera cable and parallel I/O cable lengths and monitor options, please consult your Omron vision representative.
- Fourth:** Select lenses and lighting for the application if F150-S1A or F160-S1 cameras are used. The intelligent lighting interface is available for F150-S1A and F160-S1 cameras to allow the use of controllable external lighting options. For additional intelligent lighting information and consult your Omron vision representative for assistance in selecting lenses and lighting.

Name	Model Number	Comments	
Controllers	F210-C10	NPN input/output	
	F210-C15	PNP input/output	
Double-speed cameras	with intelligent lighting	F160-SLC20	20 mm field of view
		F160-SLC50	50 mm field of view
	Camera only	F160-S1	Without lens or light source
Console	F160-KP	Keypad with shortcut buttons	
Color LCD monitor	F150-M05L	5.5 inch color LCD	
Memory card	F160-N64S	Memory capacity: 64 Mbytes	
Application software	F250-UM3FE	Flow Menu format	
Camera cable	F150-VS	For F160 (double-speed) & F150 cameras; cable length: 3 m	
Monitor cable	RCA/BNC Video Cable	Cable length: 2 m	
Parallel cable	F160-VP	Loose-wire cable for parallel I/O connectors; cable length: 2 m	
Extension tubes	F150-EXT	A set of six extension tubes that are 40, 20, 10, 5, 1, and 0.5 mm in length respectively	



Complete Family of Vision Solutions



F-10 Vision Sensor

This is the ultimate, easy-to-use, grayscale processing package for pattern and shape matching. Ultra-quick setup requires no monitor; use the one-button teach function and a visible target, integrated lens and light source. Four different camera choices are available, each with different sensing area sizes. One model even includes 8-image bank memory and RS-232C/422 communications capability.



F150-2 Vision Sensor

Use drop-down menus to set up functions including filtering; adjusting the shutter speed; background suppression; X, Y, and Theta position compensation; and image calibration. Measurement tools include center of gravity; area; edge position; edge pitch; degree of defect; and more. Get 16 setup scenes and up to 16 measurements per scene. Other features include a 23-image storage memory, RS-232C and DeviceNet communications.



F150-3 Vision Sensor with Vision Composer Software

Delivers 2-camera images with lighting control based on F150-2's format. The camera splitter unit and built-in menus or optional software allow the controller to integrate images from two cameras and perform multi-angle inspections on a single object simultaneously. The Windows®-based Vision Composer software puts more sophisticated functionality in a drag-and-drop flow chart environment.



F-160 Vision Sensor

Industry's first high-speed vision sensor to deliver mid-range machine vision performance uses two-camera image capture and fast vision algorithm processing to meet the needs of today's production applications. On-screen setup and configuration shortens time to startup for beginners and experts. A wizard-like prompted menu option helps new users with auto setup routines, while the "expert" menu option lets experienced users directly set configuration parameters. Improved algorithms – Omron's QUEST OCR and "variable box" technology – deliver more precise and sophisticated results.



F250 Vision Sensor

Use up to 4 cameras with an F250 controller for applications requiring multiple, complex inspections with high-speed analysis to maintain top quality in finished product. World's first capabilities include real-time rotation search for parts or features located at random angles and positions; edge code technology for high precision positioning; edge code defect inspection; QUEST optical character recognition and verification algorithm with built-in character libraries discern multiple characters simultaneously to eliminate teaching of characters. Application software assures simple, flexible configuration.

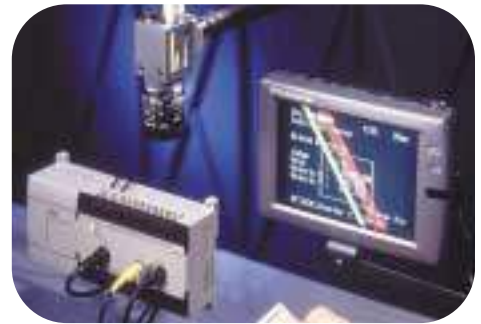

F400 Vision Sensor

The industry's first color vision sensor using hue, saturation, and intensity to combine color pickup and 5 color filters into an easy-to-use and powerful color vision solution at an affordable price. With color pickup, the F400 can be quickly configured to detect and measure up to 8 color simultaneously or use the industry's first Colorgray filter to convert a color into 256-level grayscale to analyze and measure very fine differences in the isolated color's image, even in fluctuating lighting conditions.

OMRON®

OMRON ELECTRONICS LLC
Schaumburg, IL
www.omron.com/oei

OMRON CANADA, INC.
Toronto, Ontario
www.omron.ca

SB F210-1 05/03/7.5M
© 2003 OMRON ELECTRONICS LLC
Printed in the U.S.A.

UNITED STATES REGIONAL SALES OFFICE

847.843.7900

For US technical support or other inquiries: 800.556.6766

CANADA REGIONAL SALES OFFICE

416.286.6465

MEXICO SALES OFFICES

Florida 954.227.2121 Ciudad Juarez 656.623.7083

Mexico, D.F. 555.534.1195 Monterrey, N.L. 818.377.4281

BRAZIL SALES OFFICE

55.11.5564.6488

ARGENTINA SALES OFFICE - CONO SUR

114.590.2408

AUTHORIZED DISTRIBUTOR:

