

206305-1 ✓ ACTIVE

AMP | AMP CPC

TE Internal #: 206305-1

Circular Power Connectors, Housing, 600 VDC, Wire-to-Wire, 37 Position, Wire & Cable, Plug, Reverse Gender, Pin, Power & Signal, Black, AMP CPC

[View on TE.com >](#)



Connectors > Power Connectors > Circular Power > Circular Power Connectors > Circular Connector, Environmentally Sealed, CPC Series 6



Connector Product Type: **Housing**

Operating Voltage: **600 VDC**

Connector System: **Wire-to-Wire**

Number of Positions: **37**

Sealable: **No**

[All Circular Connector, Environmentally Sealed, CPC Series 6 \(19\)](#)

Features

Product Type Features

Connector Product Type	Housing
Connector System	Wire-to-Wire
Sealable	No
Connector & Contact Terminates To	Wire & Cable
Connector & Housing Type	Plug
Circular Connector Shell Type	All Plastic

Configuration Features

Reverse Numbering	Without
Number of Positions	37
Number of Power Positions	0
Number of Signal Positions	37

Electrical Characteristics



Operating Voltage	600 VAC
-------------------	---------

Contact Features

Reverse Gender	Yes
----------------	-----

Contact Type	Pin
--------------	-----

Contact Protection	With
--------------------	------

Mechanical Attachment

Mating Alignment Type	Keyed
-----------------------	-------

Mating Alignment	With
------------------	------

Mating Retention Type	Threaded Coupling
-----------------------	-------------------

Thread Size	1-3/8 - 18 UNEF-2A
-------------	--------------------

Polarization Code	A
-------------------	---

Connector Mounting Type	Cable Mount (Free-Hanging)
-------------------------	----------------------------

Mating Retention	With
------------------	------

Panel Mount Feature	Without
---------------------	---------

Housing Features

Body Orientation	Straight
------------------	----------

Housing Color	Black
---------------	-------

Housing Material	Thermoplastic
------------------	---------------

Circular Connector Shell Size	23
-------------------------------	----

Usage Conditions

Operating Temperature Range	-55 – 105 °C[-67 – 221 °F]
-----------------------------	----------------------------

Fluid Resistance	None
------------------	------

Operation/Application

Circuit Application	Power & Signal
---------------------	----------------

Shielded	No
----------	----

Industry Standards

UL Flammability Rating	UL 94V-0
------------------------	----------

Packaging Features

Packaging Quantity	100
--------------------	-----

Packaging Method	Bag
------------------	-----

Product Compliance











[For compliance documentation, visit the product page on TE.com>](#)

EU RoHS Directive 2011/65/EU	Compliant
EU ELV Directive 2000/53/EC	Compliant
China RoHS 2 Directive MIIT Order No 32, 2016	No Restricted Materials Above Threshold
EU REACH Regulation (EC) No. 1907/2006	Current ECHA Candidate List: JUNE 2023 (235) Candidate List Declared Against: JUNE 2023 (235) Does not contain REACH SVHC
Halogen Content	Not Low Halogen - contains Br or Cl > 900 ppm.
Solder Process Capability	Not applicable for solder process capability

Product Compliance Disclaimer

This information is provided based on reasonable inquiry of our suppliers and represents our current actual knowledge based on the information they provided. This information is subject to change. The part numbers that TE has identified as EU RoHS compliant have a maximum concentration of 0.1% by weight in homogenous materials for lead, hexavalent chromium, mercury, PBB, PBDE, DBP, BBP, DEHP, DIBP, and 0.01% for cadmium, or qualify for an exemption to these limits as defined in the Annexes of Directive 2011/65/EU (RoHS2). Finished electrical and electronic equipment products will be CE marked as required by Directive 2011/65/EU. Components may not be CE marked. Additionally, the part numbers that TE has identified as EU ELV compliant have a maximum concentration of 0.1% by weight in homogenous materials for lead, hexavalent chromium, and mercury, and 0.01% for cadmium, or qualify for an exemption to these limits as defined in the Annexes of Directive 2000/53/EC (ELV). Regarding the REACH Regulation, the information TE provides on SVHC in articles for this part number is based on the latest European Chemicals Agency (ECHA) 'Guidance on requirements for substances in articles' posted at this URL: <https://echa.europa.eu/guidance-documents/guidance-on-reach>

Compatible Parts

 <p>TE Part # CAT-AM71-A17 POWERBAND Contacts</p>	 <p>TE Part # 207446-3 SEALING CAP ASSY, SZ 23, CPC</p>	 <p>TE Part # 54012-1 CPC STRAIN RELIEF, SIZE 23</p>	 <p>TE Part # CAT-AM71-C83998F Connectors with Posted Pin Contacts, CPC Series 1</p>
 <p>TE Part # CAT-AM71-C83998B CPC Cable Clamps</p>	 <p>TE Part # CAT-AM71-C83998K Circular Connector, Environmentally Sealed, CPC Series 6</p>	 <p>TE Part # 213812-1 COUPLING RING, SZ 23, CPC</p>	 <p>TE Part # CAT-AM71-C83998L CPC Sealed Accessories</p>

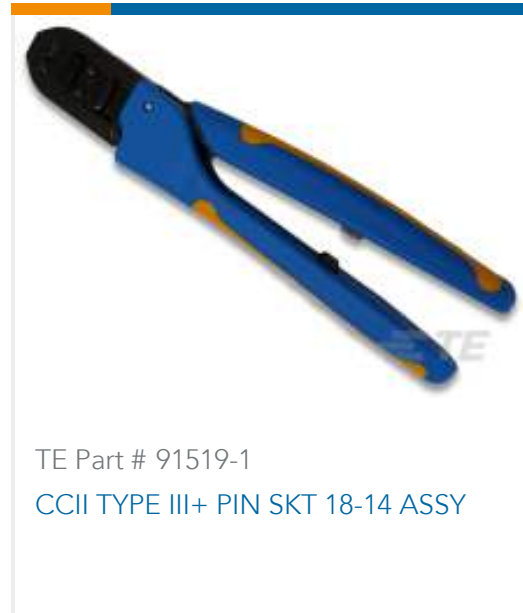
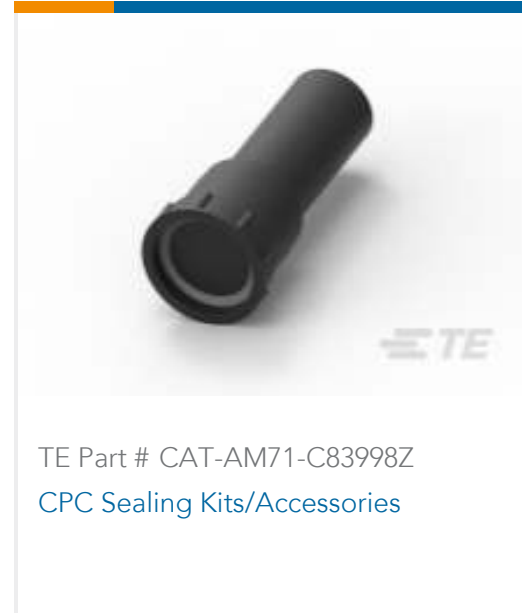
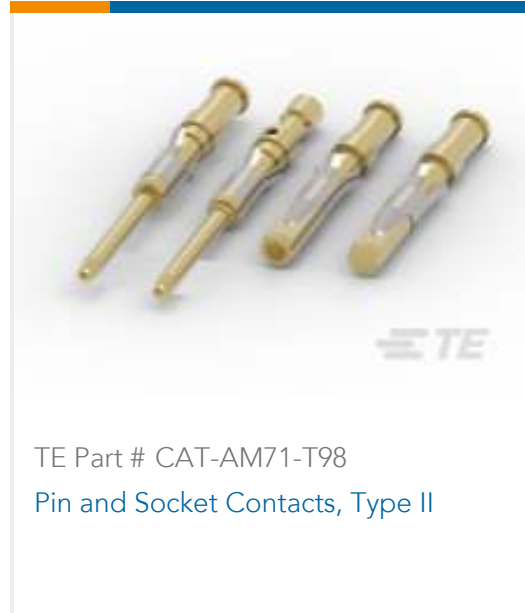
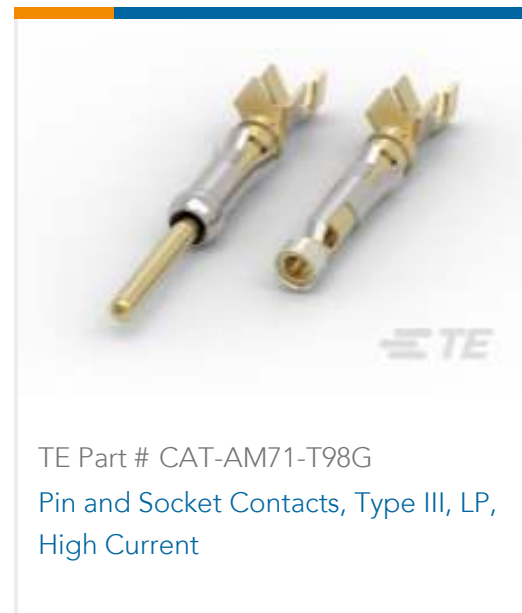
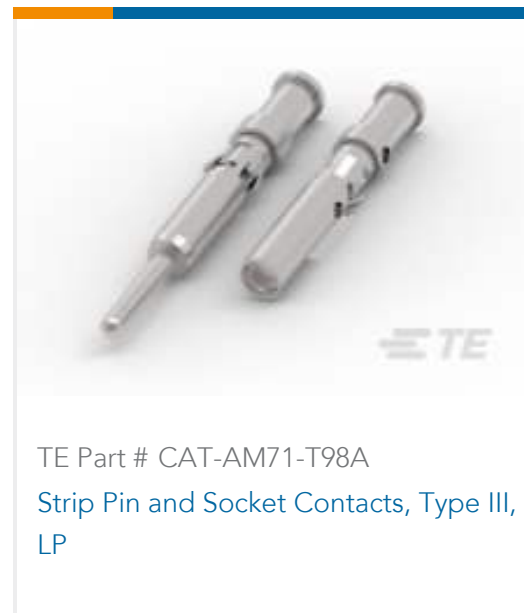
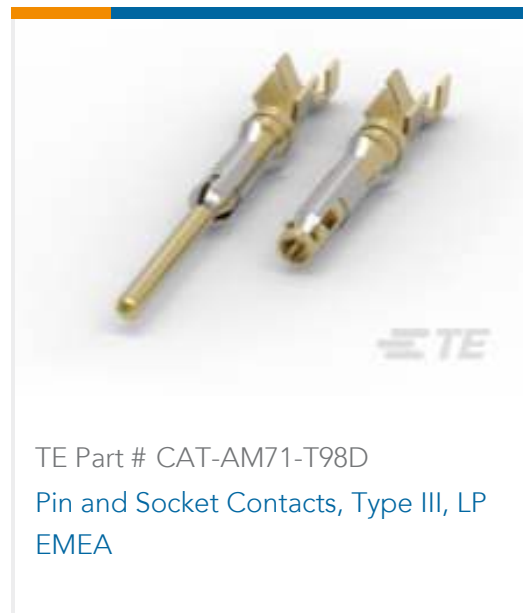
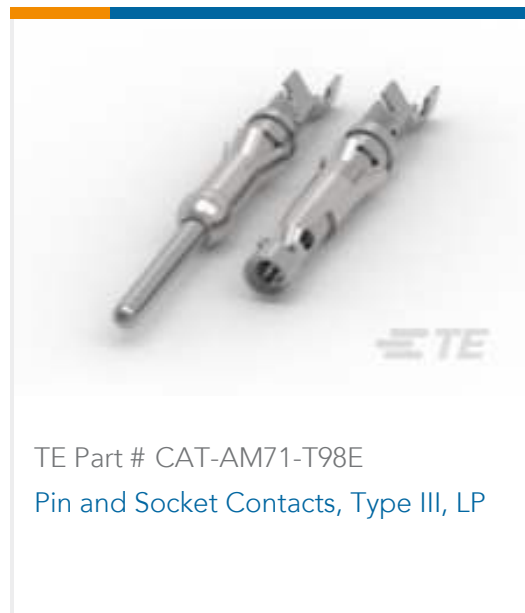

Also in the Series | AMP CPC

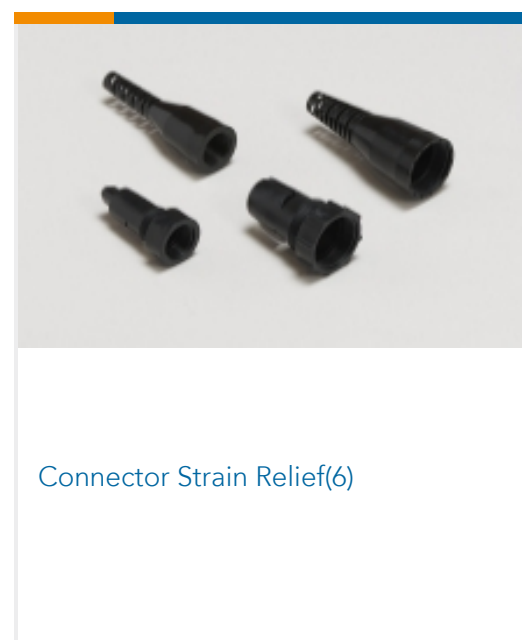
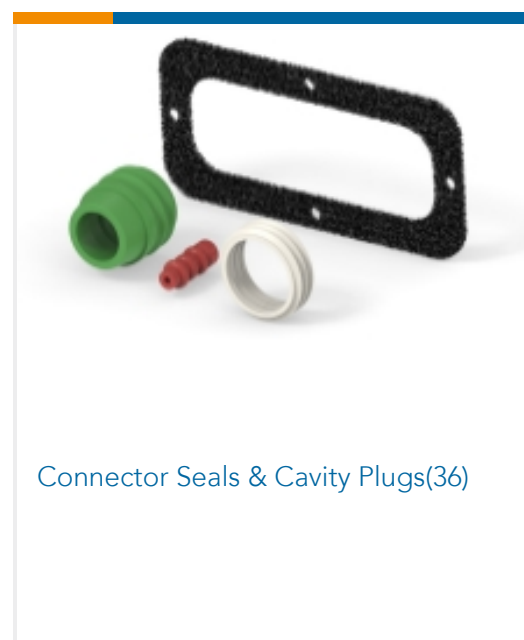
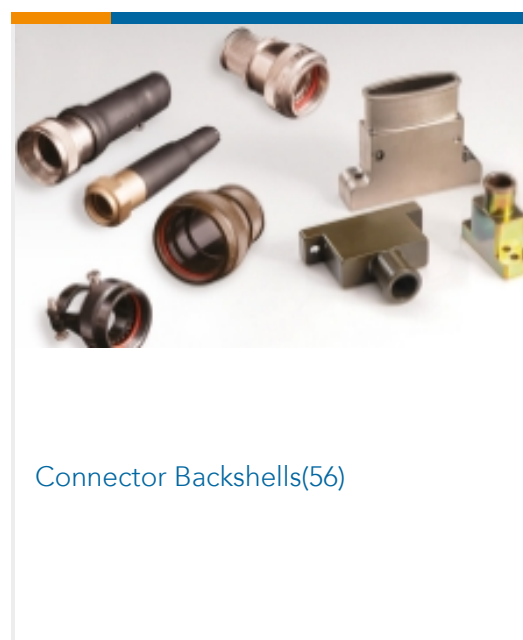
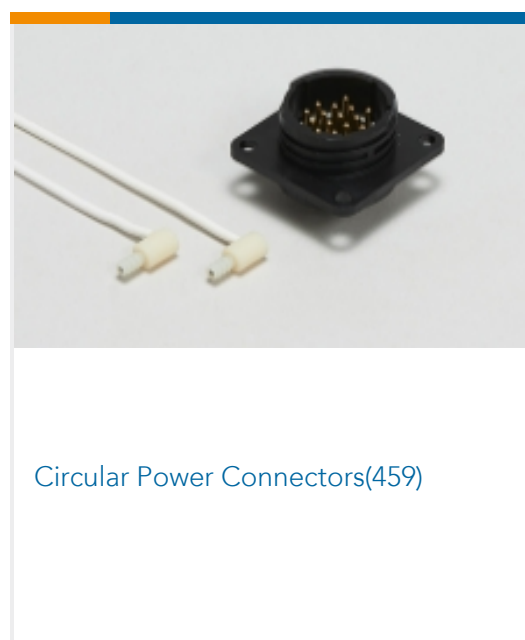
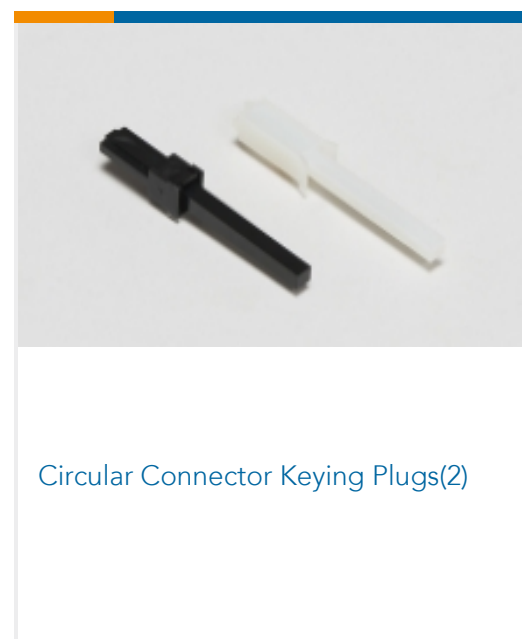
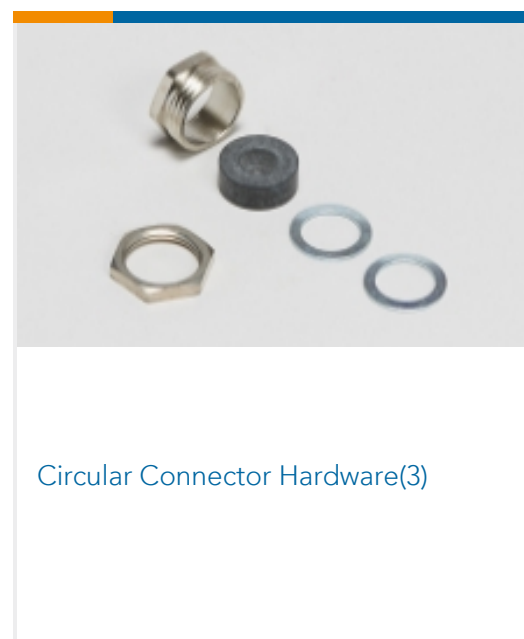
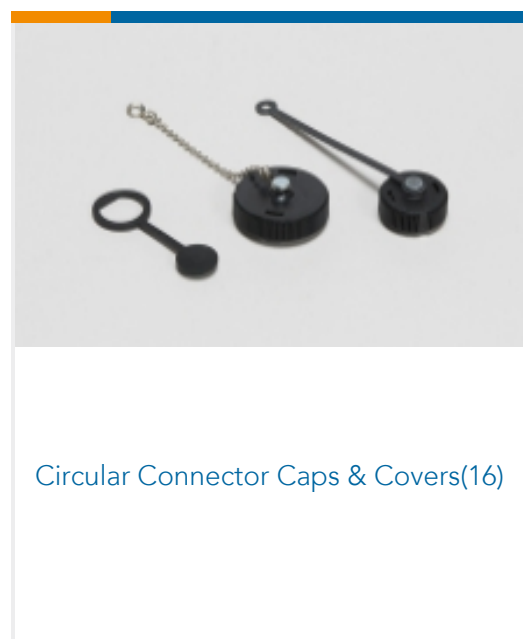
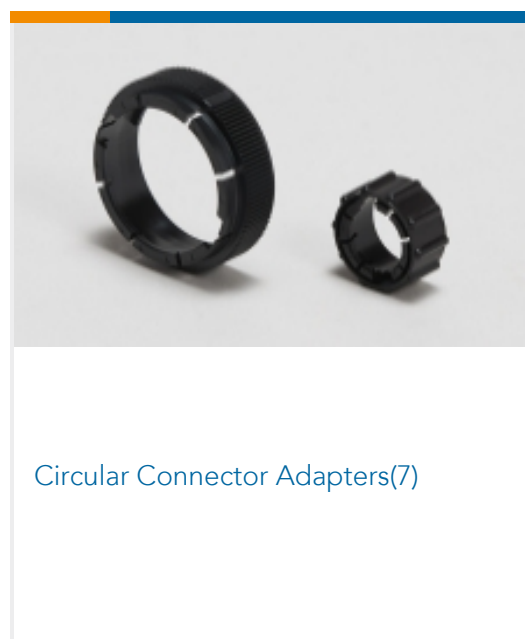



Insertion & Extraction Tools(1)

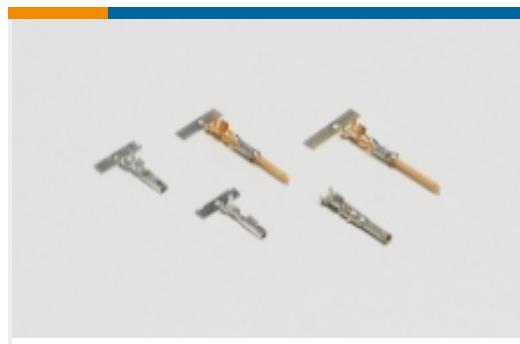

Power Contacts(6)

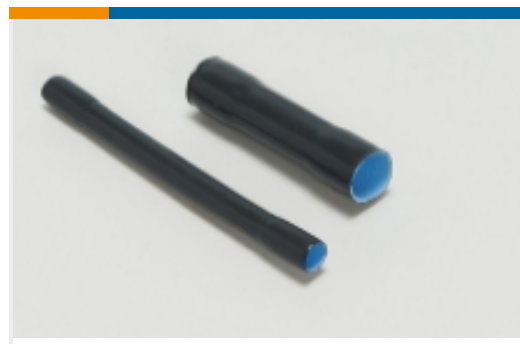

Sealing Sleeves(2)

Customers Also Bought

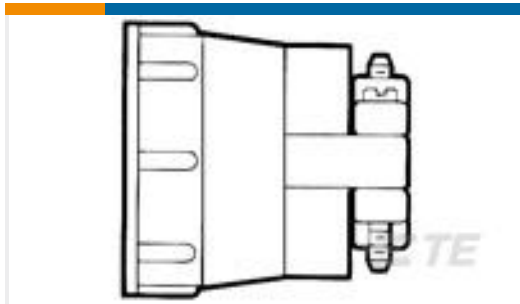

TE Part #207774-3
CLAMP CABLE SHELL,SIZE 23



TE Part #211772-1
CPC PLUG ASSEMBLY SIZE 23-19



TE Part #206437-1
CPC PLUG ASSEMBLY SIZE 23-57



TE Part #206037-1
Circular Connector, Environmentally Sealed, CPC Series 6

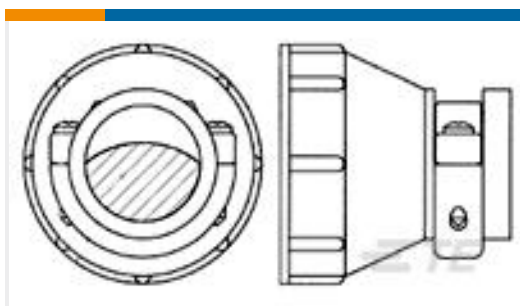

TE Part #182652-1
23 SIZE CPC STD CLAMP



TE Part #206306-2
23-37 F H RECEPT REV SEX



TE Part #C39701-000
B-155-3810



TE Part #774185P017
QS1500-NO.1-F5-0-30MM



TE Part #640138-000
QS1500-NO.4-F8-0-40MM

Documents

Product Drawings

CPC PLUG ASSEMBLY SIZE 23-37

English

CAD Files

3D PDF

3D

Customer View Model

ENG_CVM_CVM_206305-1_L.2d_dxf.zip



English

Customer View Model

[ENG_CVM_CVM_206305-1_L.3d_igs.zip](#)

English

Customer View Model

[ENG_CVM_CVM_206305-1_L.3d_stp.zip](#)

English

By downloading the CAD file I accept and agree to the [Terms and Conditions](#) of use.

Datasheets & Catalog Pages

[AMP Circular Connectors for Commercial Signal & Power Applications](#)

English

Product Specifications

[Application Specification](#)

English

Product Environmental Compliance

[MD_206305-1_07292015913_dmtec](#)

English

[MD_206305-1_07292015913_dmtec](#)

English

Instruction Sheets

[Instruction Sheet \(U.S.\)](#)

English

Agency Approvals

[UL Report](#)

English