

# Automotive Grade LTE + Wi-Fi + GNSS External Combo Antenna



**AECS1806C03Z**

Request Samples



Check Inventory



181.7 x 68.9 x 69.1 mm  
RoHS/RoHS II Compliant  
MSL Level = 1

## Features

- 3 Cabled Combo Antenna
  - 1x 4G/LTE Antenna
  - 1x 2.4/5GHz Wi-Fi Antenna
  - 1x Active GNSS/GPS/GLONASS/BeiDou/QZSS
- Manufactured in Automotive Certified lines
  - IATF 16949 certified
- PPAP available upon request
- IP67 rated
- Easy installation using Screw
- Fully customizable cable and connection options for RF connection

## Applications

- IoT
- M2M
- Smart City
- Gateways and routers
- Telematics
- Transportation
- Smart Agriculture
- Geolocation and Tracking

## Product Image



# Automotive Grade LTE + Wi-Fi + GNSS External Combo Antenna



**AECS1806C03Z**

Request Samples



Check Inventory



181.7 x 68.9 x 69.1 mm  
**RoHS/RoHS II Compliant**  
 MSL Level = 1

## Part Number Builder

AECS1806C03Z  -

Color / UV Coating	
Code	Description
<b>S</b> (Standard)	Black without UV coating
A	Black with UV Coating
B	White without UV Coating
C	White with UV Coating

Cable length in 'mm'	
Code	Description
<b>3000</b> (Standard)	3000 mm
Other Examples :	
0200	200 mm
2000	2000 mm

Cable Type & Connector Type				
Code	Cable Type	Connector Type		
		LTE	GNSS	Wi-Fi
<b>S</b> (Standard)	RG-174	SMA (M)	SMA (M)	-
	LMR-100	-	-	SMA (M)
A	LMR-100	SMA (M)	SMA (M)	SMA (M)
B		SMA (M)	FAKRA C (F)	SMA (M)
C		FAKRA D (F)	SMA (M)	SMA (M)
D		FAKRA D (F)	FAKRA C (F)	SMA (M)
E	RG-174	SMA (M)	FAKRA C (F)	-
	LMR-100	-	-	SMA (M)
F	RG-174	FAKRA D (F)	SMA (M)	-
	LMR-100	-	-	SMA (M)
G	RG-174	FAKRA D (F)	FAKRA C (F)	-
	LMR-100	-	-	SMA (M)

## Example Configurations :

Part Number	UV Protection Coating / Color	Cable length	Cable Type / Connector Type
AECS1806C03Z <b>S-3000S</b>	Yes / Black	3000 mm	2xRG-174 with 1xSMA (M) for LTE + 1xSMA (M) for GNSS + 1xLMR-100 with 1xSMA (M) for Wi-Fi (Standard)
AECS1806C03Z <b>A-1000A</b>	Yes / Black	1000 mm	3xLMR-100 with 1xSMA (M) for LTE + 1xSMA (M) for Wi-Fi and 1xSMA (M) for GNSS
AECS1806C03Z <b>B-5000G</b>	No / White	5000 mm	2xRG-174 with 1xFAKRA D (F) for LTE + 1xFAKRA C (F) for GNSS + 1xLMR-100 with 1xSMA (M) for Wi-Fi

## Note :

- For the standard part number (AECS1806C03Z **S-3000S**), please refer to the packaging at the end of the document.
- For additional configuration (AECS1806C03Z - ), MOQs, pricing and packaging changes may be applicable.



5101 Hidden Creek Ln Spicewood TX 78669  
 Phone: 512-371-6159 | Fax: 512-351-8858  
 For terms and conditions of sales, please visit:  
[www.abracon.com](http://www.abracon.com)

REVISED: 03-22-21

ABRACON IS  
 ISO9001-2015  
 CERTIFIED

# Automotive Grade LTE + Wi-Fi + GNSS External Combo Antenna



**AECS1806C03Z**

Request Samples



Check Inventory



181.7 x 68.9 x 69.1 mm  
**RoHS/RoHS II Compliant**  
 MSL Level = 1

## Electrical Specification

Parameter	Specification			Unit
	Min	Typ	Max	
<b>GNSS Antenna</b>				
Frequency	1561		1602	MHz
Gain (Zenith)			2.5	dBic
VSWR			1.5	
Impedance		50		$\Omega$
Polarization	RHCP			
<b>LNA</b>				
Noise Figure			2.0	dB
Gain	26	28	30	dB
VSWR			2.0	
Supply Voltage	3.0		5.0	V
Current Consumption			12.0	mA
<b>LTE Antenna</b>				
Frequency	698		960	MHz
	1710		2690	
VSWR			3.0	
Gain (Zenith)			3.5	dB
Impedance		50		$\Omega$
Polarization	Linear			
<b>Wi-Fi Antenna</b>				
Frequency	2400		2483.5	MHz
	4900		5825	
VSWR			2.0	
Gain (Zenith)			2.0	dB
Impedance		50		$\Omega$
Polarization	Linear			

## Mechanical Specification

Parameter	Specification
Antenna Dimension	181.7 x 68.9 x 69.1 mm
Mounting Type	Screw
RF Connector	3x SMA Male
RF Cable	2x RG174 (LTE,GNSS) + 1xLMR-100 (Wi-Fi)
Cable Length	3 m



5101 Hidden Creek Ln Spicewood TX 78669  
 Phone: 512-371-6159 | Fax: 512-351-8858  
 For terms and conditions of sales, please visit:  
[www.abracon.com](http://www.abracon.com)

REVISED: 03-22-21

ABRACON IS  
 ISO9001-2015  
 CERTIFIED

# Automotive Grade LTE + Wi-Fi + GNSS External Combo Antenna



**AECS1806C03Z**

Request Samples



Check Inventory



**181.7 x 68.9 x 69.1 mm**  
**RoHS/RoHS II Compliant**  
**MSL Level = 1**

## Environmental Specification

Parameter	Specification
Operating Temperature	-40°C to +85°C
Storage Temperature	-40°C to +85°C
Relative Humidity	Up to 95%
RoHS Compliance	Yes
PB Free	Yes
MSL	1
ESD Sensitive	Yes
Vibration	10 to 1000 Hz G = 28.7 m/s <sup>2</sup>
UL rating	UL-94 HB
Ingress Protection	IP67 (excluding cable outlet)

## Product Dimension

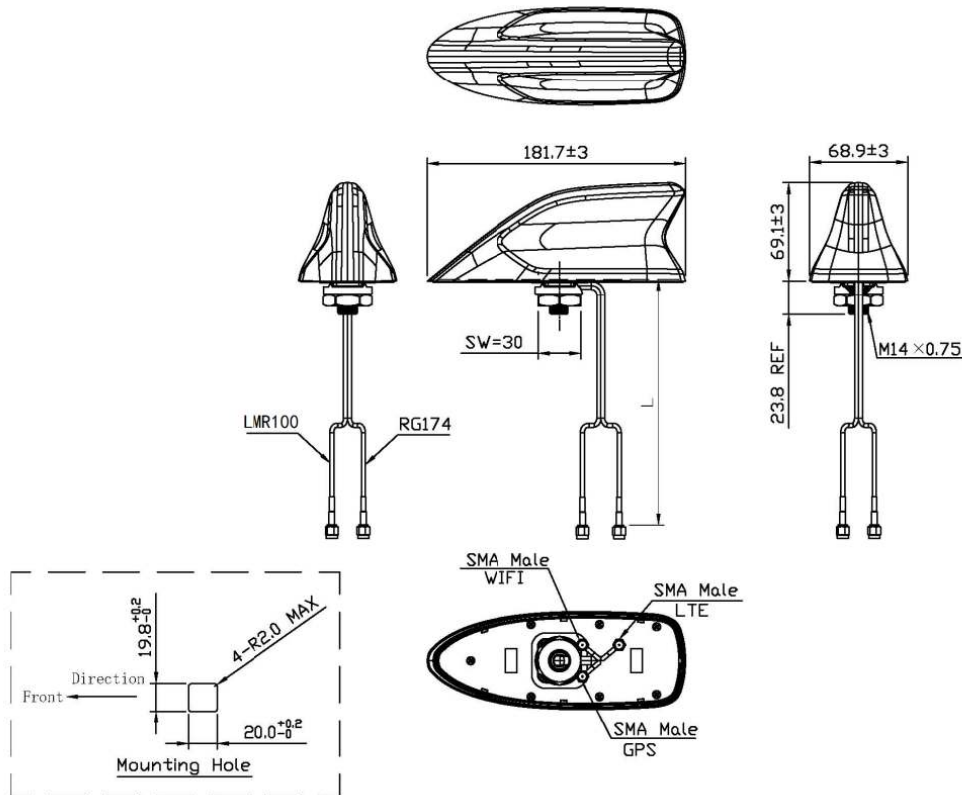

Unit: mm



5101 Hidden Creek Ln Spicewood TX 78669  
 Phone: 512-371-6159 | Fax: 512-351-8858  
 For terms and conditions of sales, please visit:  
[www.abracon.com](http://www.abracon.com)

REVISED: 03-22-21

ABRACON IS  
 ISO9001-2015  
 CERTIFIED

# Automotive Grade LTE + Wi-Fi + GNSS External Combo Antenna



**AECS1806C03Z**

Request Samples



Check Inventory



**181.7 x 68.9 x 69.1 mm**  
**RoHS/RoHS II Compliant**  
MSL Level = 1

## Test Measurements - VSWR

### GNSS

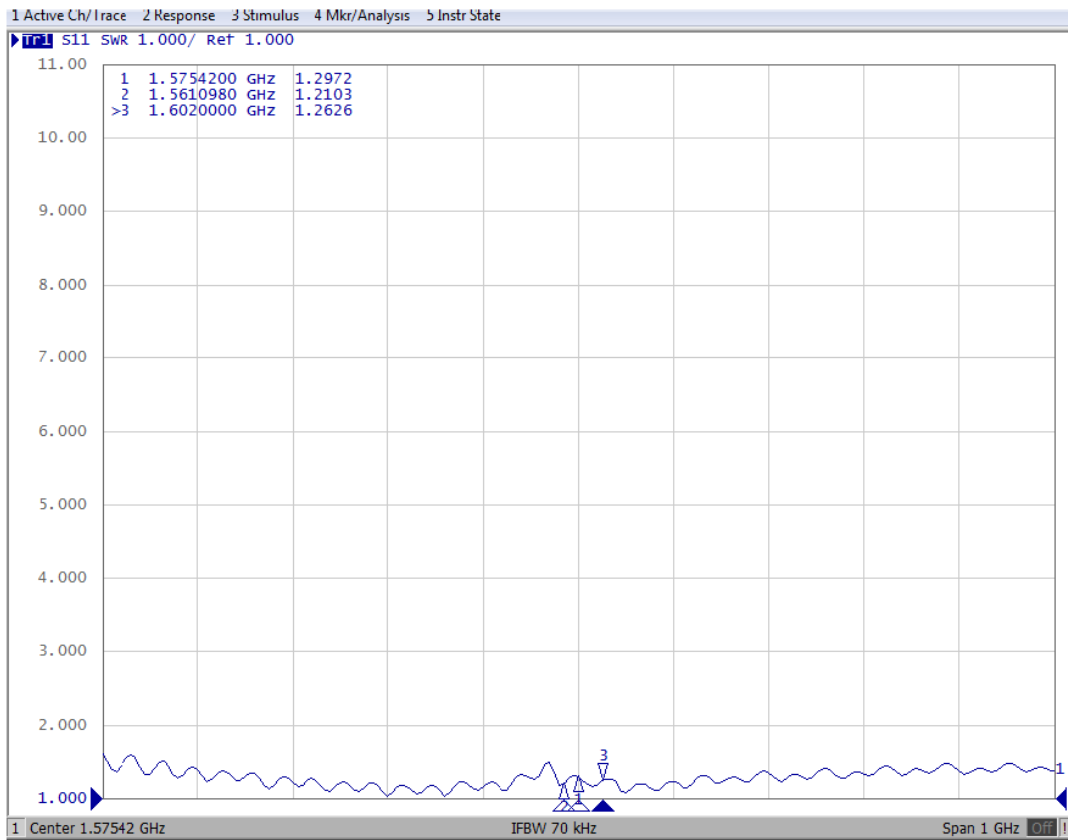

# Automotive Grade LTE + Wi-Fi + GNSS External Combo Antenna



**AECS1806C03Z**

Request Samples



Check Inventory



**181.7 x 68.9 x 69.1 mm**  
**RoHS/RoHS II Compliant**  
MSL Level = 1

**LTE**

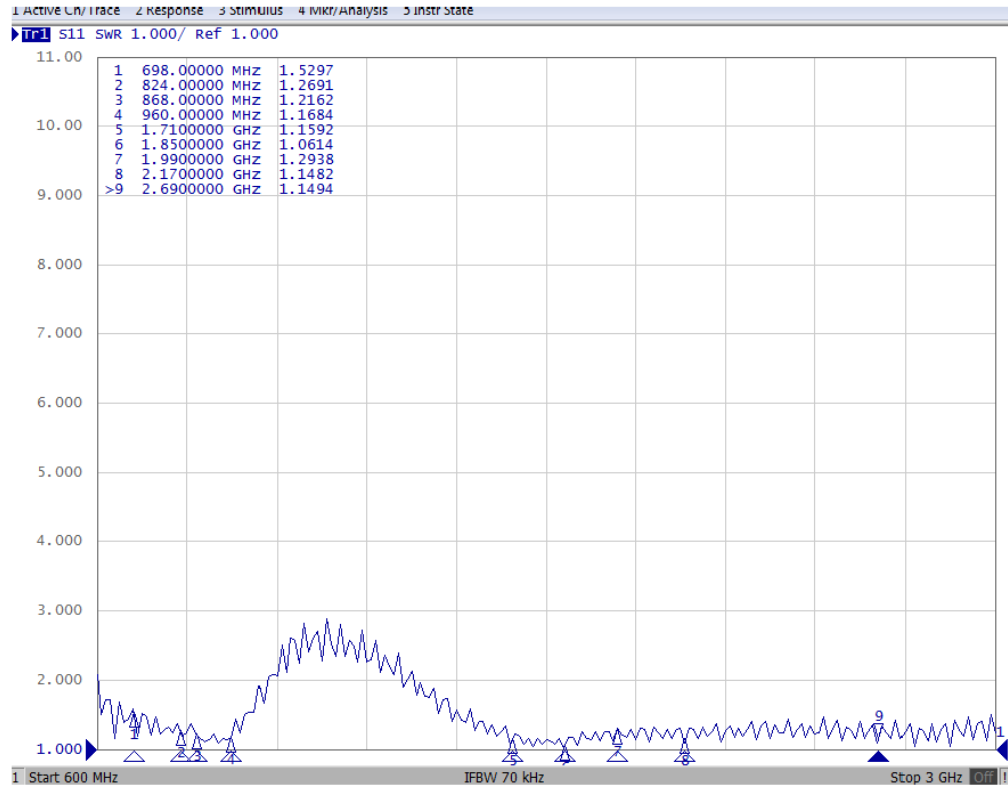

5101 Hidden Creek Ln Spicewood TX 78669  
Phone: 512-371-6159 | Fax: 512-351-8858  
For terms and conditions of sales, please visit:  
[www.abracon.com](http://www.abracon.com)

REVISED: 03-22-21

ABRACON IS  
ISO9001-2015  
CERTIFIED

# Automotive Grade LTE + Wi-Fi + GNSS External Combo Antenna



**AECS1806C03Z**

Request Samples



Check Inventory



**181.7 x 68.9 x 69.1 mm**  
**RoHS/RoHS II Compliant**  
**MSL Level = 1**

## Wi-Fi

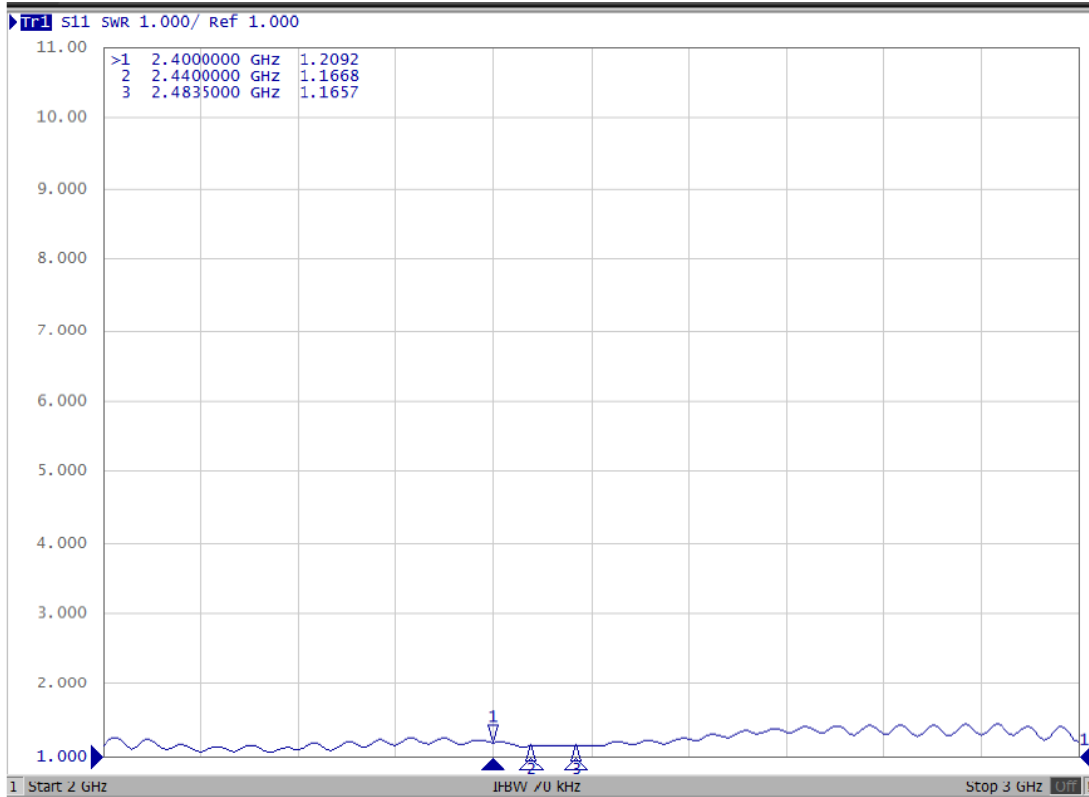

## Radiation Characteristics

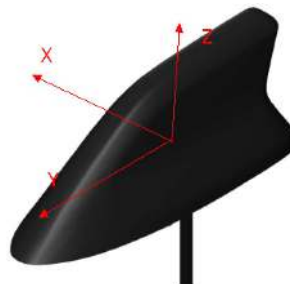

# Automotive Grade LTE + Wi-Fi + GNSS External Combo Antenna



AECS1806C03Z

Request Samples



Check Inventory



181.7 x 68.9 x 69.1 mm  
RoHS/RoHS II Compliant  
MSL Level = 1

## 2D Pattern

### GNSS

#### XY - Plane

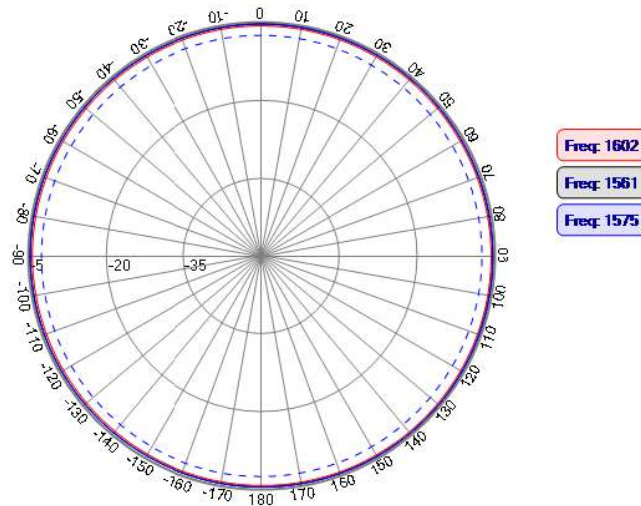

#### XZ - Plane

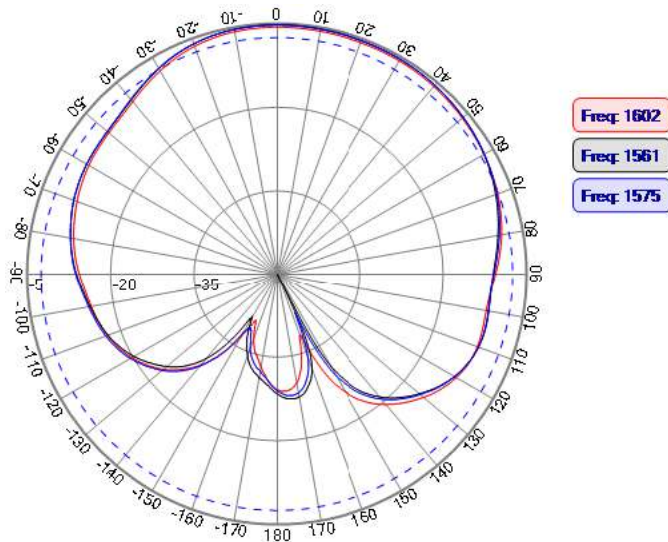

#### YZ - Plane

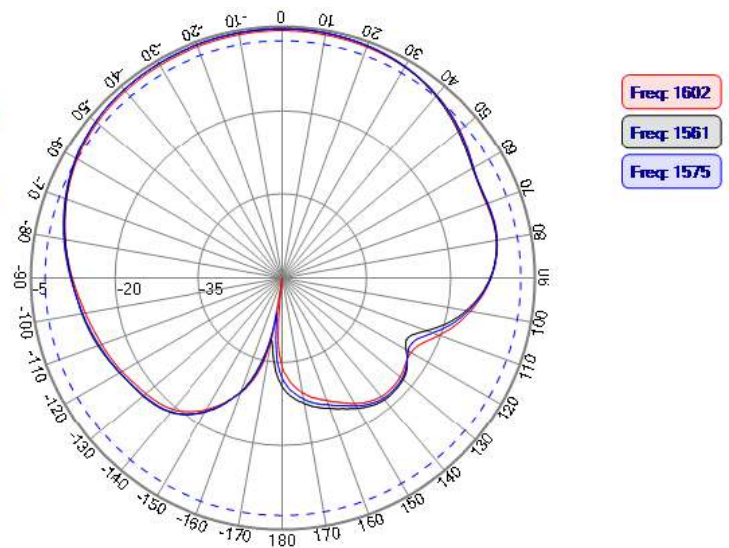

5101 Hidden Creek Ln Spicewood TX 78669  
Phone: 512-371-6159 | Fax: 512-351-8858  
For terms and conditions of sales, please visit:  
[www.abracon.com](http://www.abracon.com)

REVISED: 03-22-21

ABRACON IS  
ISO9001-2015  
CERTIFIED



# Automotive Grade LTE + Wi-Fi + GNSS External Combo Antenna



AECS1806C03Z

Request Samples



Check Inventory



181.7 x 68.9 x 69.1 mm  
RoHS/RoHS II Compliant  
MSL Level = 1

## LTE

XY - Plane

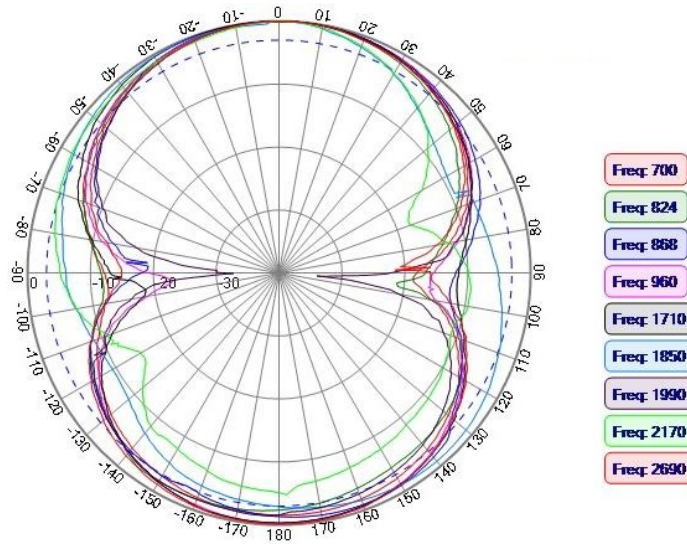

XZ - Plane

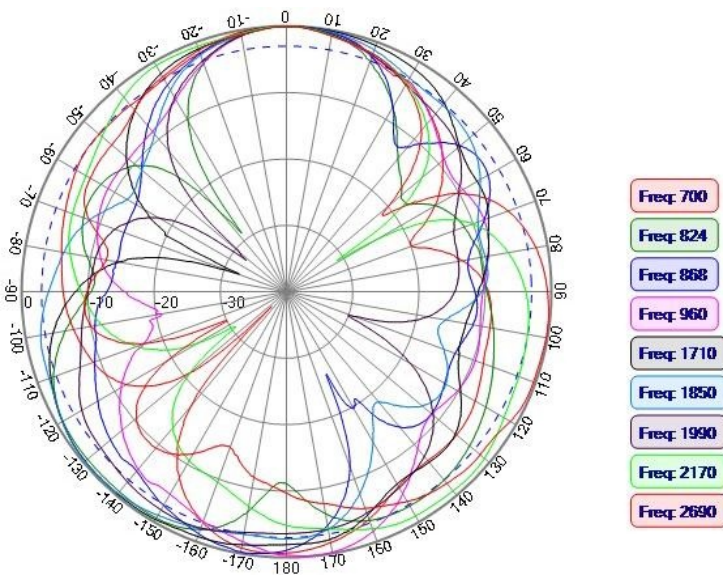

YZ - Plane

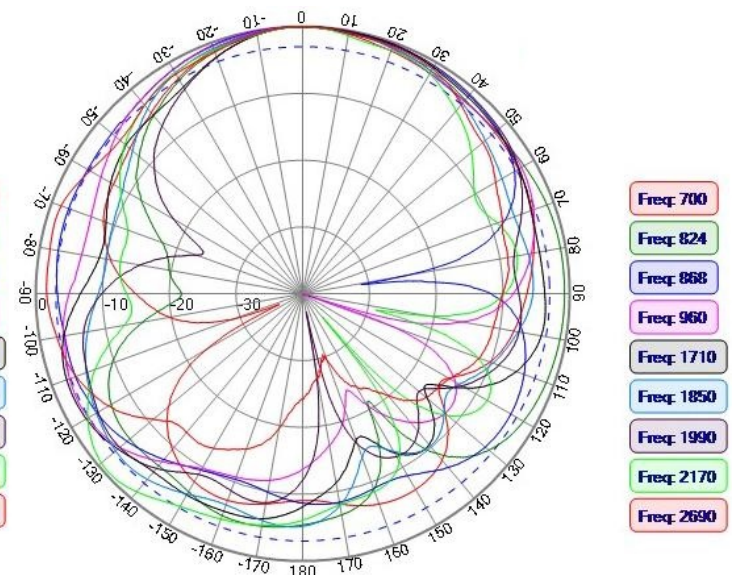

5101 Hidden Creek Ln Spicewood TX 78669  
Phone: 512-371-6159 | Fax: 512-351-8858  
For terms and conditions of sales, please visit:  
[www.abracon.com](http://www.abracon.com)

REVISED: 03-22-21

ABRACON IS  
ISO9001-2015  
CERTIFIED

# Automotive Grade LTE + Wi-Fi + GNSS External Combo Antenna



**AECS1806C03Z**

Request Samples



Check Inventory



**181.7 x 68.9 x 69.1 mm**  
**RoHS/RoHS II Compliant**  
**MSL Level = 1**

## Wi-Fi

### XY - Plane

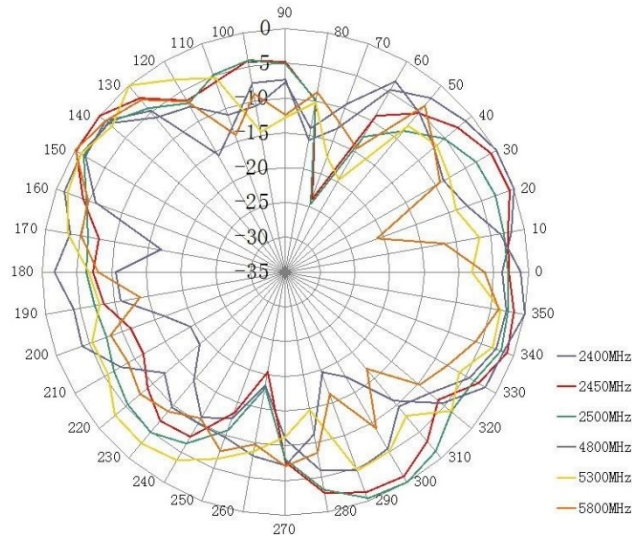

### XZ - Plane

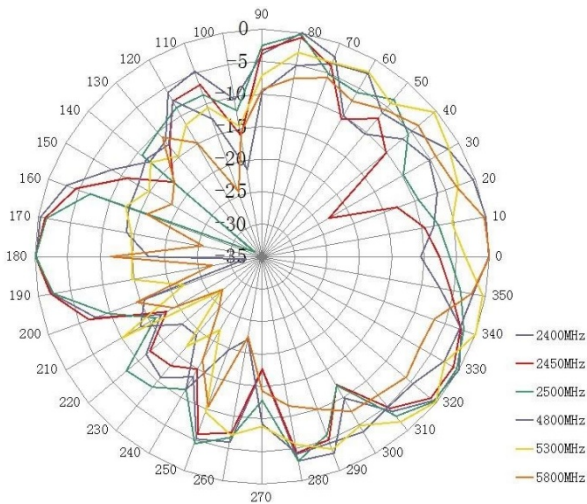

### YZ - Plane

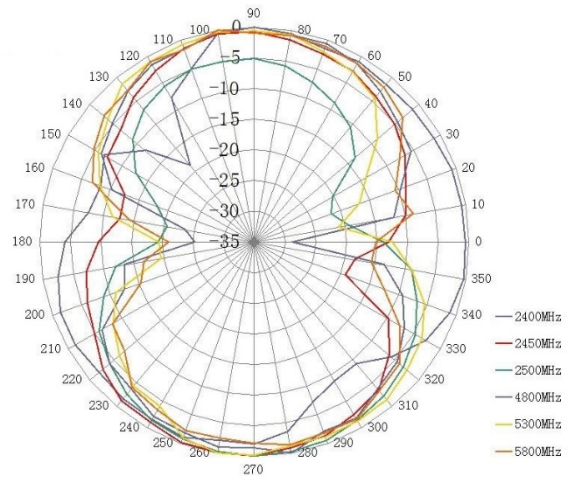

5101 Hidden Creek Ln Spicewood TX 78669  
Phone: 512-371-6159 | Fax: 512-351-8858  
For terms and conditions of sales, please visit:  
[www.abracon.com](http://www.abracon.com)

REVISED: 03-22-21

ABRACON IS  
ISO9001-2015  
CERTIFIED

# Automotive Grade LTE + Wi-Fi + GNSS External Combo Antenna



AECS1806C03Z

Request Samples



Check Inventory



181.7 x 68.9 x 69.1 mm  
RoHS/RoHS II Compliant  
MSL Level = 1

## 3D Pattern

### LTE

698 MHz

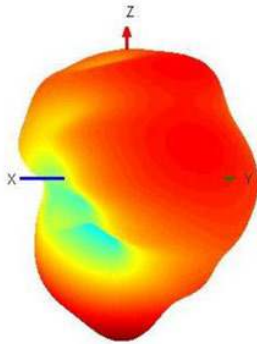

824 MHz

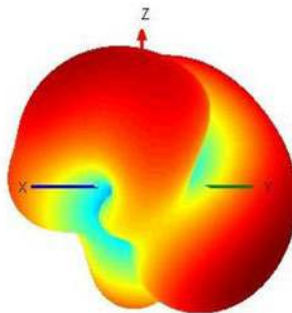

868 MHz

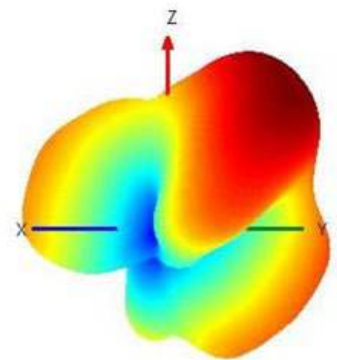

960 MHz

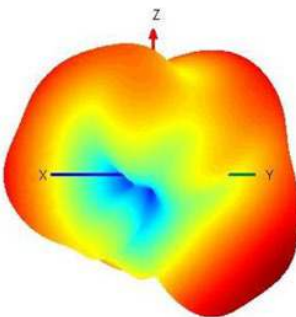

1710 MHz

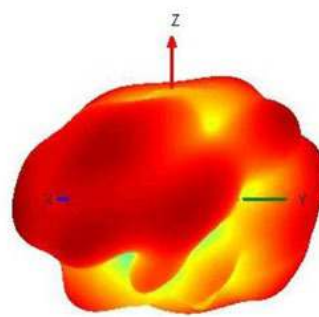

1850 MHz

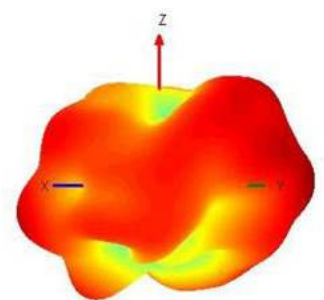

1990 MHz

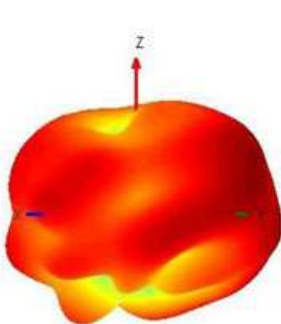

2170 MHz

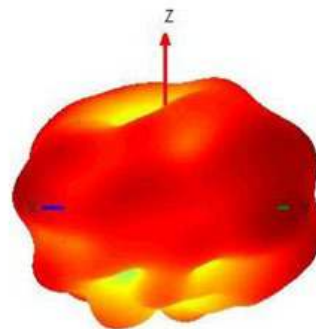

2690 MHz

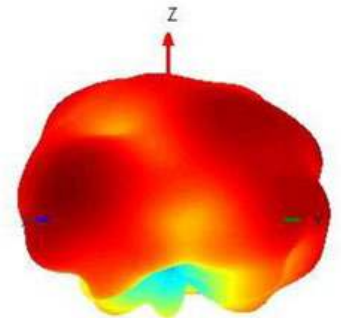

# Automotive Grade LTE + Wi-Fi + GNSS External Combo Antenna



**AECS1806C03Z**

Request Samples



Check Inventory



181.7 x 68.9 x 69.1 mm  
**RoHS/RoHS II Compliant**  
 MSL Level = 1

## Wi-Fi

2400 MHz

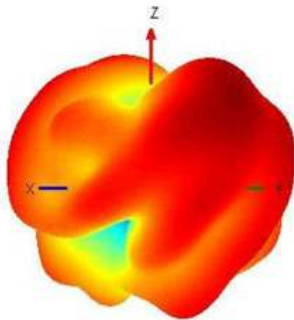

2440 MHz

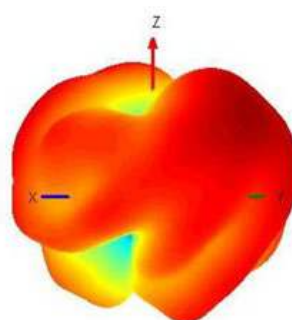

2483 MHz

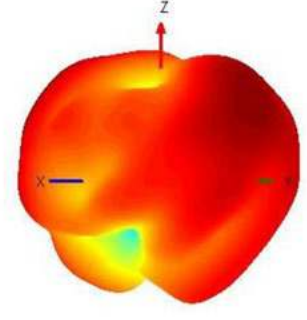

## Gain and Efficiency

Frequency (MHz)	Gain (dBi)	Efficiency
<b>LTE</b>		
698	3.57	0.69
824	2.28	0.61
868	2.32	0.56
960	2.1	0.57
1710	1.11	0.57
1850	0.32	0.52
1990	0.75	0.57
2170	1.97	0.59
2690	0.94	0.58
<b>Wi-Fi</b>		
2400	2.07	0.56
2440	1.49	0.58
2483	1.85	0.54

# Automotive Grade LTE + Wi-Fi + GNSS External Combo Antenna



**AECS1806C03Z**

Request Samples



Check Inventory



**181.7 x 68.9 x 69.1 mm**  
**RoHS/RoHS II Compliant**  
MSL Level = 1

## Packaging Information

Number of Antenna/ Carton : 12 pcs  
Weight of 1 pc of the antenna : 470 g  
Dimension of the Carton : 495 x 220 x 270 mm  
Weight of the carton : 6 kg

**ATTENTION:** Abracon LLC's products are COTS – Commercial-Off-The-Shelf products; suitable for Commercial, Industrial and, where designated, Automotive Applications. Abracon's products are not specifically designed for Military, Aviation, Aerospace, Life-dependent Medical applications or any application requiring high reliability where component failure could result in loss of life and/or property. For applications requiring high reliability and/or presenting an extreme operating environment, written consent and authorization from Abracon LLC is required. Please contact Abracon LLC for more information.



5101 Hidden Creek Ln Spicewood TX 78669  
Phone: 512-371-6159 | Fax: 512-351-8858  
For terms and conditions of sales, please visit:  
[www.abracon.com](http://www.abracon.com)

**REVISED: 03-22-21**

ABRACON IS  
ISO9001-2015  
CERTIFIED