

# 10/100Base-T Vertical RJ45 w/ LEDs

ARJC07-111071A

Request Samples



Check Inventory



16.0 x 16.7 x 16.9mm  
RoHS/RoHS II Compliant  
MSL Level = 1

## Features

- Available with or without LED
- Suitable CAT 5 & 6 cable and UTP
- Comply IEEE 802.3ab
- Integrated LAN Magnetics
- Suitable for RoHS compliant reflow

## Applications

- 10/100 Base-T LAN
- NIC, LoM and PC
- Industrial IoT/IoT
- Machine-to-machine (M2M)
- Industrial process control
- Industrial robotics
- Media converters

## Electrical Specifications

Parameters	Minimum	Typical	Maximum	Units	Notes
Turn Ratio ( $\pm 3\%$ )	1CT:1CT				100kHz, 0.1V
Inductance	350			$\mu\text{H}$	100kHz, 0.1V, 8mADC
Hipot	1500			VDC	1mA Max Complies with IEEE 802.3
Operating Temperature	-40		+85	$^{\circ}\text{C}$	
Storage Temperature	-40		+85	$^{\circ}\text{C}$	
Insertion Loss	-1.0			dB	1-100MHz
Return Loss			-18	dB	1-10MHz
			-16		10-30MHz
			-14		30-60MHz
			-12		60-80MHz
			-10		80-100MHz
Crosstalk			-35	dB	1.0-100MHz
CMRR			-35	dB	1.0-100MHz



5101 Hidden Creek Ln Spicewood TX 78669  
Phone: 512-371-6159 | Fax: 512-351-8858  
For terms and conditions of sales, please visit:  
www.abracon.com

REVISED: 01-21-20

ABRACON IS  
ISO9001-2015  
CERTIFIED

# 10/100Base-T Vertical RJ45 w/ LEDs

ARJC07-111071A

Request Samples



Check Inventory



16.0 x 16.7 x 16.9mm  
RoHS/RoHS II Compliant  
MSL Level = 1

## Mechanical Specifications

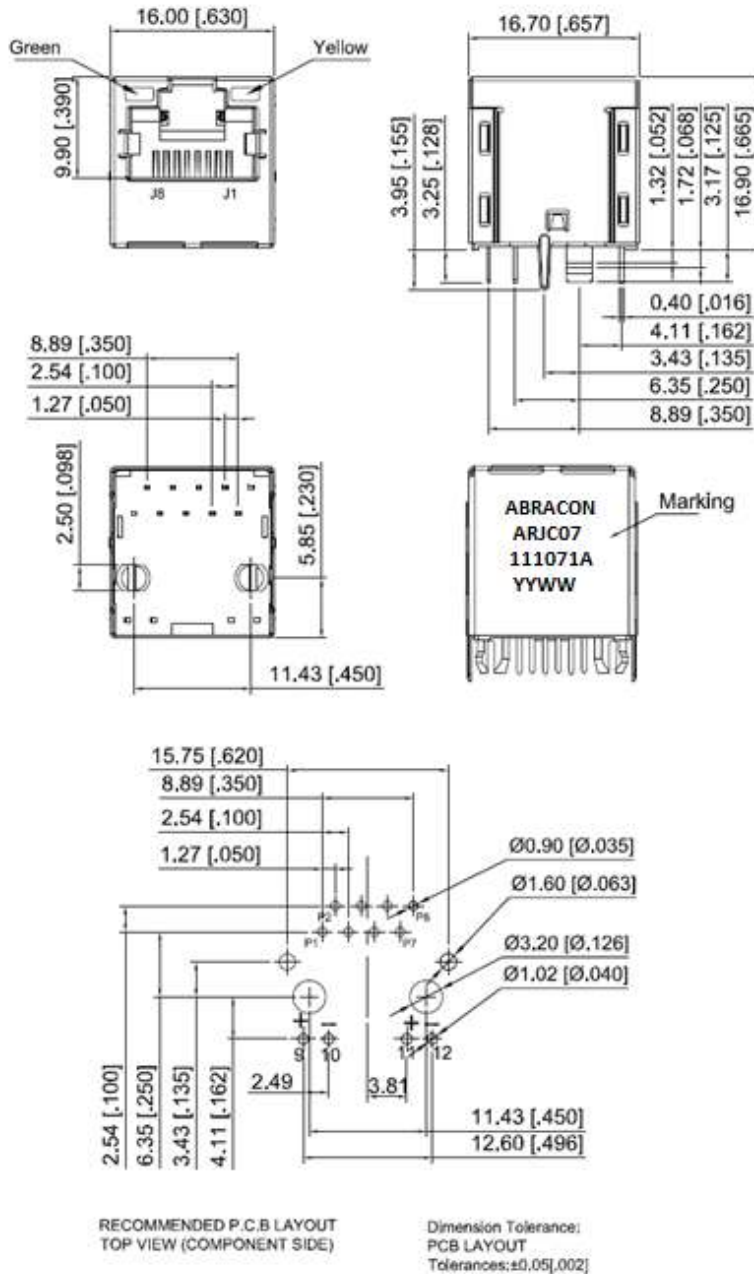

**\*\*Cosmetic differences may occur and do not affect the product's form, fit or function.**



5101 Hidden Creek Ln Spicewood TX 78669  
Phone: 512-371-6159 | Fax: 512-351-8858  
For terms and conditions of sales, please visit:  
[www.abracon.com](http://www.abracon.com)

REVISED: 01-21-20

ABRACON IS  
ISO9001-2015  
CERTIFIED

# 10/100Base-T Vertical RJ45 w/ LEDs

ARJC07-111071A

Request Samples



Check Inventory



16.0 x 16.7 x 16.9mm  
RoHS/RoHS II Compliant  
MSL Level = 1

## Schematic

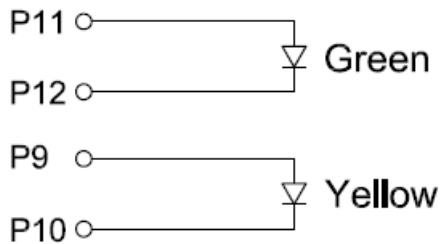
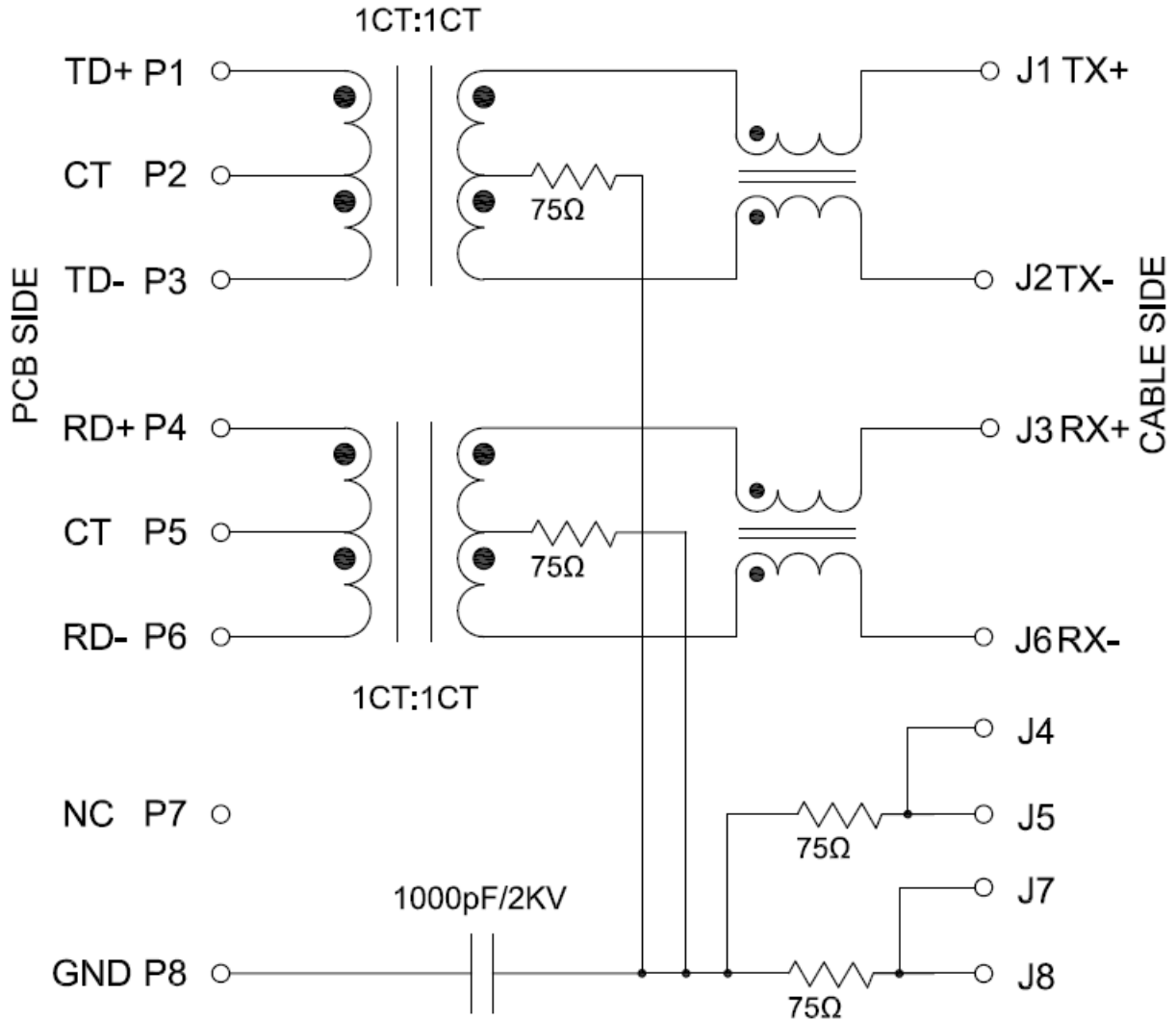

(Left: Green – Right: Yellow):

Color	Green	Yellow
Wavelength	565nm Typ	590nm Typ
Forward Voltage	2.2V Typ	2.1V Typ

# 10/100Base-T Vertical RJ45 w/ LEDs

ARJC07-111071A

Request Samples



Check Inventory



16.0 x 16.7 x 16.9mm  
RoHS/RoHS II Compliant  
MSL Level = 1

## Part Marking

---

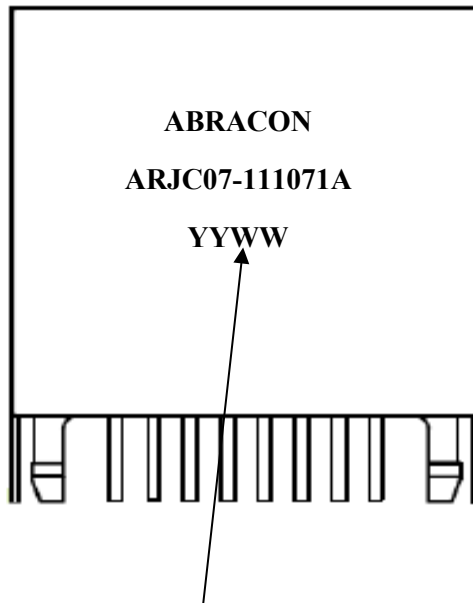

YY: Year: E.g. 20 for 2020  
WW: Week: E.g. 05 for the 5<sup>th</sup>  
week of the year.

Marking Method = Laser Marking



5101 Hidden Creek Ln Spicewood TX 78669  
Phone: 512-371-6159 | Fax: 512-351-8858  
For terms and conditions of sales, please visit:  
[www.abracon.com](http://www.abracon.com)

REVISED: 01-21-20

ABRACON IS  
ISO9001-2015  
CERTIFIED

# 10/100Base-T Vertical RJ45 w/ LEDs

ARJC07-111071A

Request Samples



Check Inventory



16.0 x 16.7 x 16.9mm  
RoHS/RoHS II Compliant  
MSL Level = 1

## Materials

---

### 1. Housing:

Material:

PBT, UL94V-0 (for wave soldering option)

LCP, UL94V-0 (for IR reflow soldering option)

Standard Color: Black

### 2. Insert:

Material:

PBT, UL94V-0 (for wave soldering option)

LCP, UL94V-0 (for IR Reflow soldering option)

Contact Material: Phosphor Bronze

Plating (1): Nickel

Plating (2): Gold, 6u"

### 3. Metal Shell:

Material: Brass

Plating (1): Nickel

### 4. Contact Pin:

Material: Phosphor Bronze

Plating (1): Nickel

Plating (2): 100%Sn

### 5. LED:

Material: Diffused Epoxy Lens, 0.5x0.5mm Carbon Steel wireframe leads

**Note: Abracon LLC will not alter any material composition, without prior written notification.**



5101 Hidden Creek Ln Spicewood TX 78669  
Phone: 512-371-6159 | Fax: 512-351-8858  
For terms and conditions of sales, please visit:  
[www.abracon.com](http://www.abracon.com)

REVISED: 01-21-20

ABRACON IS  
ISO9001-2015  
CERTIFIED

# 10/100Base-T Vertical RJ45 w/ LEDs

ARJC07-111071A

Request Samples



Check Inventory



16.0 x 16.7 x 16.9mm  
RoHS/RoHS II Compliant  
MSL Level = 1

## Wave Profile

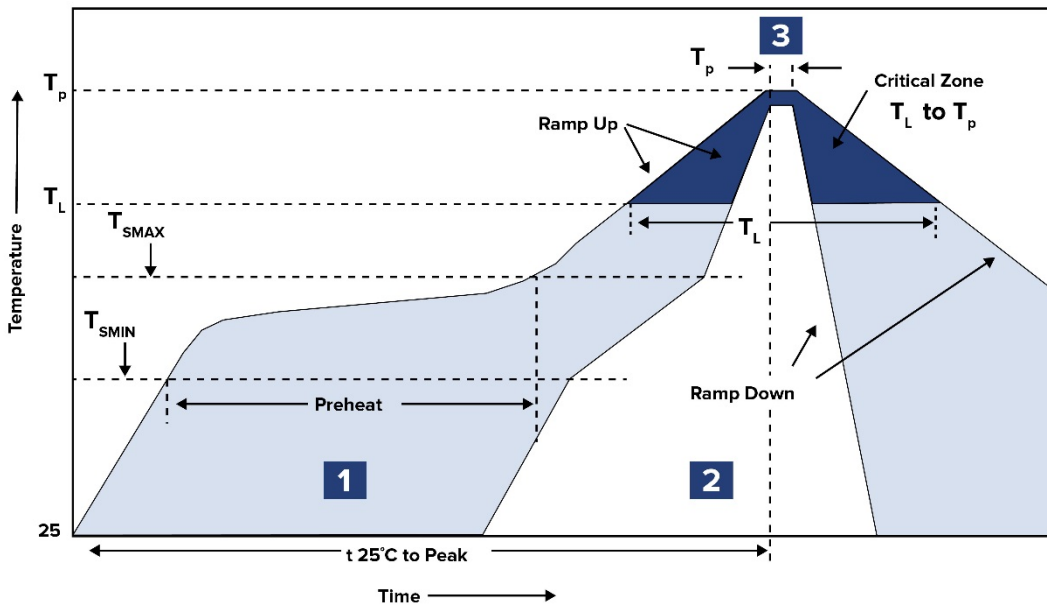

	Description	Temperature	Times
1	Preheat	$T_{SMIN} \sim T_{SMAX}$ 150°C ~ 180°C	120 ~ 180 sec.
2	Reflow	$T_L$ 217°C	60 ~ 150 sec.
3	Peak heat	$T_P$ 245°C±5°C	5 sec. MAX

# 10/100Base-T Vertical RJ45 w/ LEDs

ARJC07-111071A

Request Samples



Check Inventory



16.0 x 16.7 x 16.9mm  
RoHS/RoHS II Compliant  
MSL Level = 1

## Packaging

Bulk/Tray (60pcs/tray, 22 trays/carton)

Tray Size: 315.0 x 200.0 mm, Transparent PET

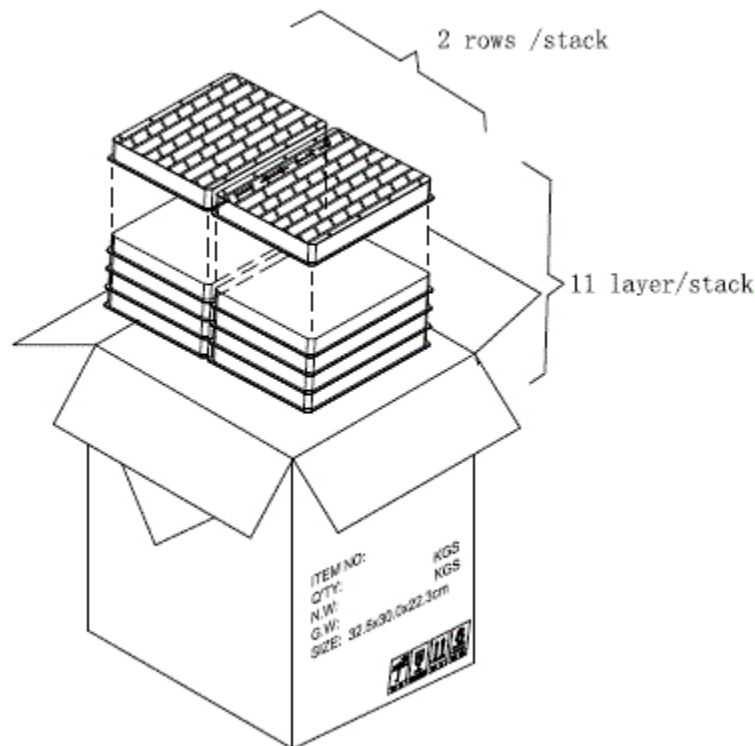
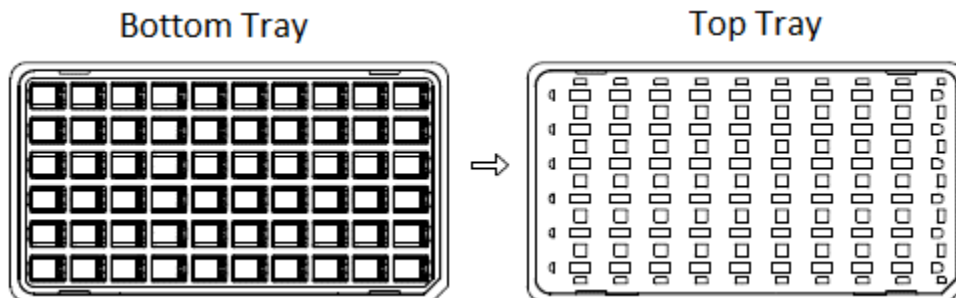

Dimensions: mm

**ATTENTION:** Abracon LLC's products are COTS – Commercial-Off-The-Shelf products; suitable for Commercial, Industrial and, where designated, Automotive Applications. Abracon's products are not specifically designed for Military, Aviation, Aerospace, Life-dependent Medical applications or any application requiring high reliability where component failure could result in loss of life and/or property. For applications requiring high reliability and/or presenting an extreme operating environment, written consent and authorization from Abracon LLC is required. Please contact Abracon LLC for more information.



5101 Hidden Creek Ln Spicewood TX 78669  
Phone: 512-371-6159 | Fax: 512-351-8858  
For terms and conditions of sales, please visit:  
[www.abracon.com](http://www.abracon.com)

REVISED: 01-21-20

ABRACON IS  
ISO9001-2015  
CERTIFIED