

Note: All part numbers are RoHS Compliant.

Index—Eurostyle

**One-Piece Board Mount
(Cage Clamp)**

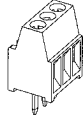

	Page No.	Page No.	Page No.
16-30 AWG	Straight		
2.54 mm Centerline	8	—	—
5.08 mm Centerline	8	—	—

**Low Profile
High Temperature and Standard**

	Page No.	Page No.	Page No.
16-28 AWG	Straight		
3.5 mm Centerline	9	—	—
3.81 mm Centerline	9	—	—

Stacking with Interlock

	Straight	Rt.-Angle	
14-30 AWG			
3.50 mm Centerline	9	19	—
3.81 mm Centerline	10	19	—

**Low Profile
Stacking with Interlock**

	Straight	Rt.-Angle	
16-30 AWG			
5.00 mm Centerline	11	20	—
5.08 mm Centerline	11	21	—
10.00 mm Centerline	16, 17	24	—
10.16 mm Centerline	18	25	—

Stacking with Interlock

	Straight	Rt.-Angle	Angled
12-30 AWG			
5.00 mm Centerline	12	20, 21, 28	26
5.08 mm Centerline	13, 14	21, 22	26
7.50 mm Centerline	14, 15	23	—
7.62 mm Centerline	15, 16	23	—
10.00 mm Centerline	16, 17	24	27
10.16 mm Centerline	18	25	27

**High Current
Stacking with Interlock**

	Straight	Rt.-Angle	Angled
10-24 AWG			
6.35 mm Centerline	29	—	—
9.52 mm Centerline	29	—	30

**Multi-Level Stacking
with Interlock
1st and 2nd Level**

16-30 AWG	
5.00 mm Centerline	32
5.08 mm Centerline	33

12-30 AWG	
5.00 mm Centerline	32
5.08 mm Centerline	33, 34

**Multi-Level Stacking with Interlock
2nd and 3rd Level**

16-30 AWG	
5.08 mm Centerline	34
12-30 AWG	
5.08 mm Centerline	35

**Multi-Level Stacking
with Interlock
Three Levels**

	Page No.
16-30 AWG	
5.00 mm Centerline	35
5.08 mm Centerline	36

12-30 AWG	
5.00 mm Centerline	36
5.08 mm Centerline	37

**Multi-Level Stacking
with Interlock 2nd Level**

16-30 AWG	
5.00 mm Centerline	38
5.08 mm Centerline	39

12-30 AWG	
5.00 mm Centerline	38, 39
5.08 mm Centerline	40

**Multi-Level Stacking
with Interlock 3rd Level**

16-30 AWG	
5.00 mm Centerline	41
10.00 mm Centerline	43

12-30 AWG	
5.00 mm Centerline	41
5.08 mm Centerline	42

**One-Piece Board Mount
(Wire Protector Version)**

Straight Stacking with Interlock

14-22 AWG	
5.00 mm Centerline	95

**Low Profile
Straight Stacking with Interlock
(LT)**

14-22 AWG	
5.00 mm Centerline	95, 97

**Straight Stacking with Interlock
(LT)**

18-26 AWG	
3.50 mm Centerline	96

14-22 AWG	
5.00 mm Centerline	98

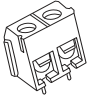
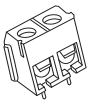
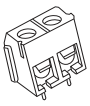
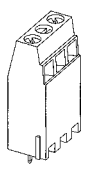
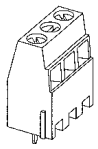
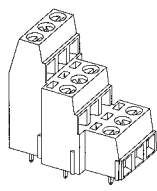
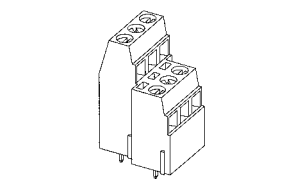
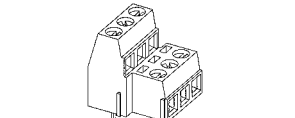
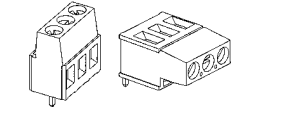
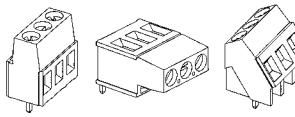
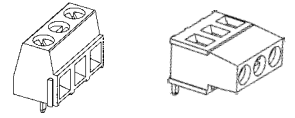
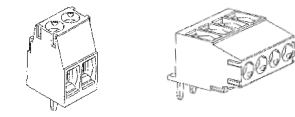

Table of Contents

Note: The BUCHANAN brand name is listed on most pages in this catalog. Tyco Electronics Corporation is consolidating AMP, BUCHANAN and RDI brand Terminal Blocks under the BUCHANAN brand. The form, fit and function of the former RDI and AMP Terminal Blocks will NOT change. In a "running" change, only the molded "RDI" and "AMP" logos on the housings will change to "BUCHANAN" logos. In some cases, a BUCHANAN or RDI series of part numbers has been replaced by an equivalent product, which may currently be labeled BUCHANAN, RDI or AMP product.

AMP, AGASTAT, BUCHANAN, FASTON, MIDTEX, PIDG, PIVOT BLOCK, PLASTI-GRIP, P&B, RDI, SCHRACK, SNAPTRACK, the TE Logo, and TYCO ELECTRONICS are trademarks.

NEMA is a trademark of the National Electrical Manufacturers Association.

Craftsman, Duramax, Ryton, Sears, Stanley and Xcelite are trademarks of their respective companies.

Other products, logos, and Company names mentioned herein may be trademarks of their respective owners.

©2001, 2002, 2006 and 2007 by Tyco Electronics Corporation. All Rights Reserved.

Eurostyle Terminal Blocks

Index	3-5
Introduction (Stacking Screw Clamp Connectors)	6
PC Board Mount Connector Styles	7
One-Piece Board Mount.....	8-44
Two-Piece	45-81
Straight Plugs	82-84
Unshrouded Straight Pin Headers	85
Special Plug Connectors	86-88
Flush Mount	89-92
Wire Protector	93
Surface Mount	94-102
Screwless	104-106
Accessories	107-111

Barrier Strips

Table of Contents	113
-------------------------	-----

Tri-Barrier Strips

Connector Index	119
-----------------------	-----

Dual-Barrier Strips

Connector Index	139
-----------------------	-----

Barrier Strip Sockets

Connector Index	161
-----------------------	-----

Accessories

.....	174-179
-------	---------

Card Edge Connector Systems

Table of Contents	181
-------------------------	-----

Interface Module Systems

Table of Contents	195
-------------------------	-----

Europa Terminal Blocks

Table of Contents	213
-------------------------	-----

NEMA Terminal Blocks

Table of Contents	239
-------------------------	-----

Part Number Cross Reference

.....	297
-------	-----

Appendix – Recommended Screw Tightening Torque

.....	326
-------	-----

Restriction on the use of Hazardous Substances (RoHS)

At Tyco Electronics, we're ready to support your RoHS requirements. We've assessed more than 1.5 million end items/components for RoHS compliance, and issued new part numbers where any change was required to eliminate the restricted materials.

Part numbers in this catalog are RoHS Compliant, unless marked otherwise. These products comply with European Union Directive 2002/95/EC as amended 1 January 2006 that restricts the use of lead, mercury, cadmium, hexavalent chromium, PBB, and PBDE in

certain electrical and electronic products sold into the EU as of 1 July 2006.

Note - For purposes of this Catalog, included within the definition of RoHS Compliant are products that are clearly "Out of Scope" of the RoHS Directive such as hand tools and other non-electrical accessories. Information regarding RoHS compliance is provided based on reasonable inquiry of our suppliers and represents our current actual knowledge based on the information provided by our suppliers. This information is subject to change. For latest compliance status, refer to our website referenced at right.

Getting the Information You Need

Our comprehensive on-line RoHS Customer Support Center provides a forum to answer your questions and support your RoHS needs. A RoHS FAQ (Frequently Asked Questions) is available with links to more detailed information. You can also submit RoHS questions and receive a response within 24 hours during a normal work week. The Support Center also provides:

- n Cross-Reference from Non-compliant to Compliant Products
- n Ability to browse RoHS Compliant Products in our on-line catalog

- n Downloadable Technical Data
 - n Customer Information Presentation
 - n More detailed information regarding the definitions used above
- So whatever your questions when it comes to RoHS, we've got the answers at www.tycoelectronics.com/leadfree



Note: All part numbers are RoHS Compliant.

Index—Eurostyle

One-Piece Board Mount (Wire Protector Version)

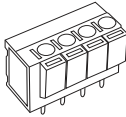
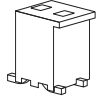
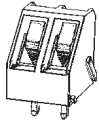

Two-Piece

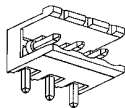
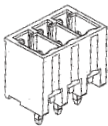
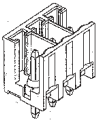
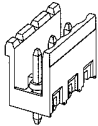

45° Wire Inlet with Interlock (LT)

14-22 AWG	Page No.
5.00 mm Centerline	99
5.08 mm Centerline	99

SMT with Wire Trap

2.5 mm Centerline	101
-------------------	-----

Screwless

14-22 AWG	
5.00 mm Centerline	103-105
5.08 mm Centerline	103-105

Straight Open End Headers

5.00 mm Centerline	51
5.08 mm Centerline	52
7.50 mm Centerline	53
7.62 mm Centerline	54
10.00 mm Centerline	55
10.16 mm Centerline	56

Straight Open End Headers with Interlock

3.50 mm Centerline	49
3.81 mm Centerline	50
5.00 mm Centerline	57
5.08 mm Centerline	57

Straight Closed End Headers

3.50 mm Centerline	49
3.81 mm Centerline	50
5.00 mm Centerline	51
5.08 mm Centerline	52
7.50 mm Centerline	53
7.62 mm Centerline	54
10.00 mm Centerline	55
10.16 mm Centerline	56

Right-Angle Open End Stacking Headers

5.00 mm Centerline	59
5.08 mm Centerline	61
7.50 mm Centerline	62
7.62 mm Centerline	63
10.00 mm Centerline	64
10.16 mm Centerline	65

Two-Piece (Continued)

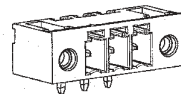
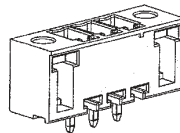
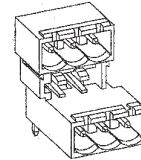
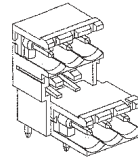
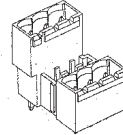
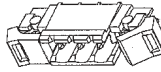
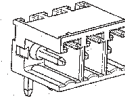
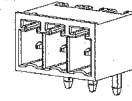

Right-Angle Closed End Headers

	Page No.
3.50 mm Centerline	58
3.81 mm Centerline	58
5.00 mm Centerline	59
5.08 mm Centerline	61
7.50 mm Centerline	62
7.62 mm Centerline	63
10.00 mm Centerline	64
10.16 mm Centerline	65

Right-Angle Open End Headers with Interlock

5.00 mm Centerline	66
5.08 mm Centerline	66

Right-Angle Closed End Headers with Ejectors

5.08 mm Centerline	67
--------------------	----

Straight Closed End Double-Row Headers with Interlock

5.00 mm Centerline	68
5.08 mm Centerline	68
10.00 mm Centerline	69
10.16 mm Centerline	69

Right-Angle Open End Double-Row Headers with Interlock

5.00 mm Centerline	70
5.08 mm Centerline	70

Right-Angle Closed End Double-Row Headers with Interlock

5.00 mm Centerline	71
5.08 mm Centerline	71
10.00 mm Centerline	72
10.16 mm Centerline	72

Straight Headers with Threaded Flange

3.50 mm Centerline	45
3.81 mm Centerline	45
5.08 mm Centerline	46

Right-Angle Closed End Headers with Threaded Flange

3.50 mm Centerline	47
3.81 mm Centerline	47
5.00 mm Centerline	48
5.08 mm Centerline	48

Index—Eurostyle

Two-Piece (Continued)

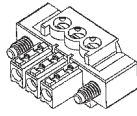

Right-Angle Plugs with Screw Flange	Page No.
14-30 AWG	
3.50 mm Centerline	73
3.81 mm Centerline	73
12-30 AWG	
5.00 mm Centerline	74
5.08 mm Centerline	74

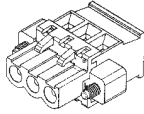

Straight Plugs with Screw Flange, Left- and Right-Hand Versions	Page No.
12-30 AWG	
5.08 mm Centerline	75

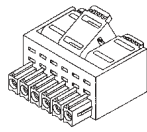

PIVOT BLOCK Plugs (IDC)	Page No.
22-24 AWG	
3.5 mm Centerline	102

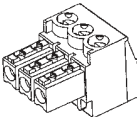

Right-Angle Plugs	Page No.
14-30 AWG	
3.50 mm Centerline	76
3.81 mm Centerline	76

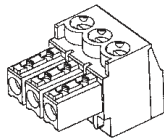

Right-Angle Plugs with Interlock	Page No.
14-30 AWG	
3.81 mm Centerline	80

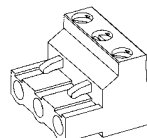

Right-Angle Plugs with Retention Latch	Page No.
12-30 AWG	
5.00 mm Centerline	77
5.08 mm Centerline	77
7.50 mm Centerline	78
7.62 mm Centerline	78
10.00 mm Centerline	79
10.16 mm Centerline	79

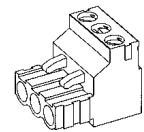

Right-Angle Stacking Plugs with Retention Latch and Interlock	Page No.
12-30 AWG	
5.00 mm Centerline	81
5.08 mm Centerline	81

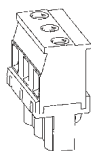

Straight Plugs with Retention Latch, Left- and Right-Hand Versions	Page No.
12-30 AWG	
5.00 mm Centerline	82
5.08 mm Centerline	83
7.50 mm Centerline	84
7.62 mm Centerline	84
10.00 mm Centerline	84
10.16 mm Centerline	84

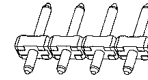

Unshrouded Pin Headers	Page No.
5.0 mm Centerline	85
10.0 mm Centerline	85

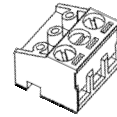

Special 90°/180° and 90°/270° Plug Connectors	Page No.
14-30 AWG	
5.0 mm Centerline	86, 87
10.0 mm Centerline	88

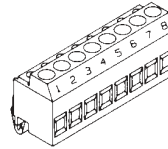

Flush-Mount Plug-In Connectors with Cage Clamp	Page No.
12-30 AWG	
5.00 mm Centerline	89
5.08 mm Centerline	91

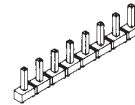

Unshrouded Pin Headers	Page No.
5.00 mm Centerline	90
5.08 mm Centerline	92

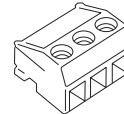

Flush Mount Plug	Page No.
14-22 AWG	
5.00 mm Centerline	100

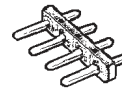

Straight Unshrouded Pin Header	Page No.
5.00 mm Centerline	100

Accessories

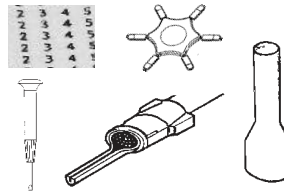

Labeling	106
Polarization Keys	107
Screwdrivers	107
Wire Pins	108
Wire Ferrules	109, 110

Stacking Screw Clamp Connectors

Product Facts

- n **Certified by the VDE Testing and Certification Institute**
 VDE File No. 6917
 (Two-Piece Version)
 VDE File No. 6920
 (One-Piece Version)
 
- n **Recognized under the Component Program of Underwriters Laboratories Inc.,**
 File No. E60677
 
- n **Certified by Canadian Standards Association,**
 File No. 703157
 
- n **Produced under Quality Management System certified to ISO 9001**

Technical Documents

- Product Specification:**
108-20166 Terminal Block Connectors, Stacking PC Board Mount
- Application Specification:**
114-20079 Terminal Block Stacking Connectors

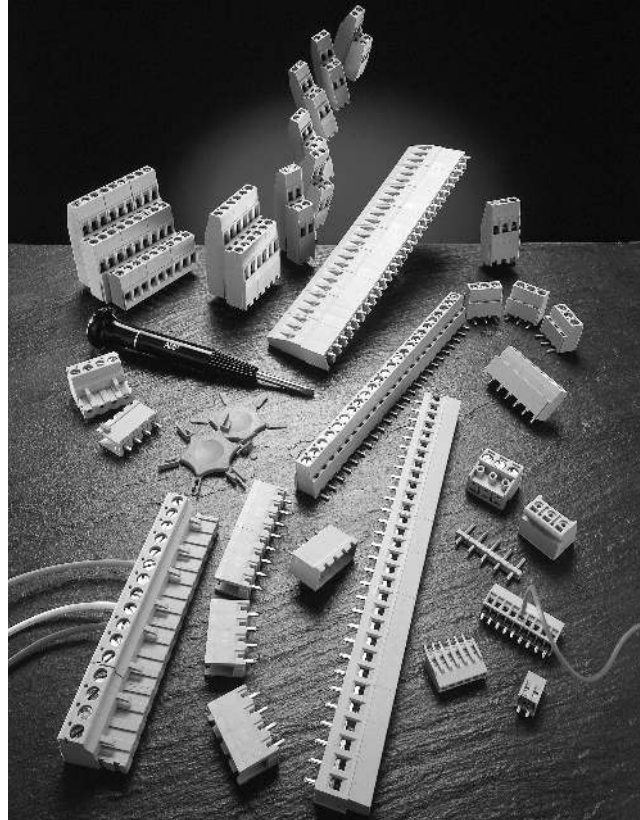

Terminal Block connectors feature the special rising cage clamp design (see illustration on page 7). The modular design of Terminal Block connectors consists of one-piece board mount terminal blocks and plug connectors with mating straight and right-angle shrouded headers. A special version – which can be mated either 90° or 180° – completes the product line. Terminal Block connectors offer several advantages:

- n IR Reflow compatible
- n Terminal Block connectors have a rising cage clamp which promotes numerous reliable connections and disconnections at field installations
- n All blocks are supplied with open screws which shortens the time for connection
- n The double captive screw system guards against lost screws

- n All metal parts are non-magnetic
- n The housing material used is halogen free Polyamide 6.6 according to UL 94V-0 (self-extinguishing); operating temperature -40°C to +105°C
- n The housing funnel entry design enables an easier product application
- n The open bottom design facilitates the PCB washing and reduces trapping of soldering fumes and dirt, with better insulation
- n Available on the board mount connectors is test probe access to determine if an electrical connection has been made
- n Contacts are post tinned with nickel underplate which allows the product to be used in specially corrosive environments

Board mount connectors, as well as pc board plugs and headers, are stackable end-

to-end without loss of centerline spacing.

Ease of assembly is facilitated by built-in interlocks on the housings. Pre-assembled products can be delivered upon request. Adhesive labels are available to number the cavities. Customer specific labeling is also available upon request.

Terminal Block connectors are interchangeable with most existing products and pc board footprint is fully compatible with existing Industry Standards.

Note: All part numbers are RoHS Compliant.

Terminal Block Board Mount Connectors

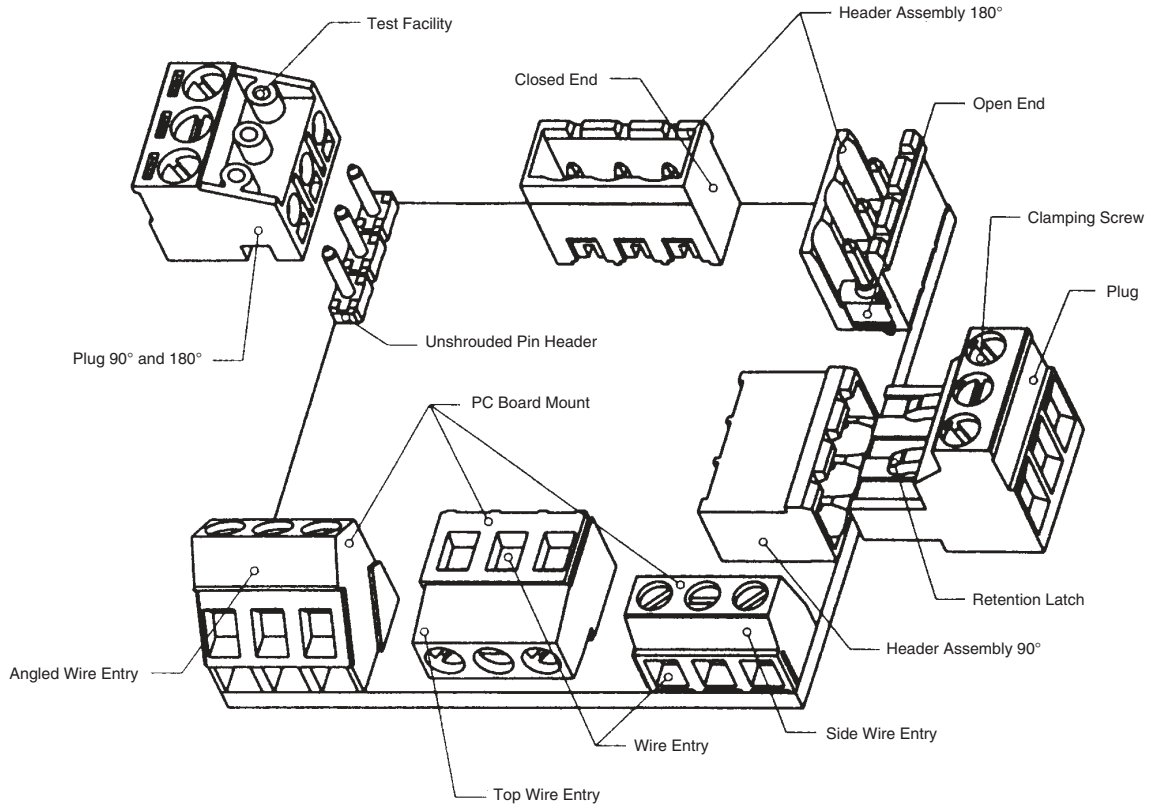

Rising Cage Clamp Design

Cross Section One-Piece Connector

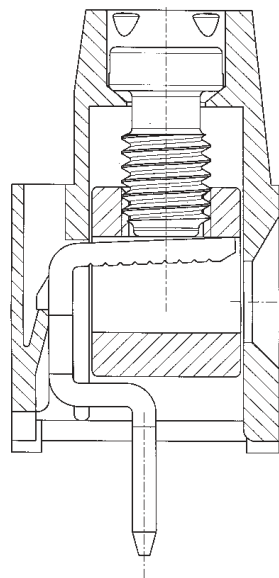

Cross Section Two-Piece Connector

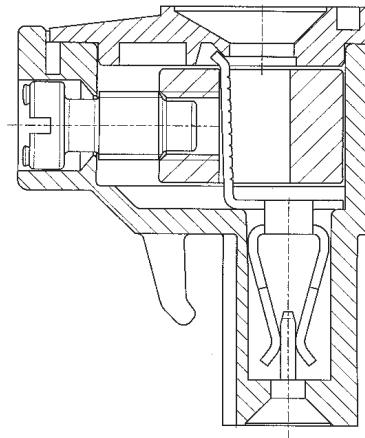

Note: All part numbers are RoHS Compliant.

Board Mount, Side Wire Entry

**Board Mount,
2.54 mm Centerline,
Side Wire Entry**
**UL Rating – 150 V, 10 A
16-30 AWG**

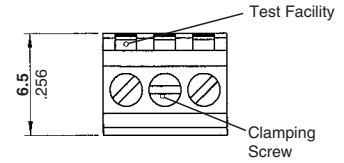
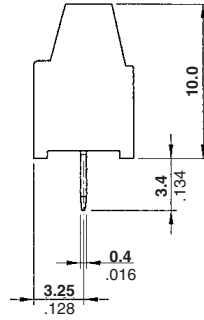
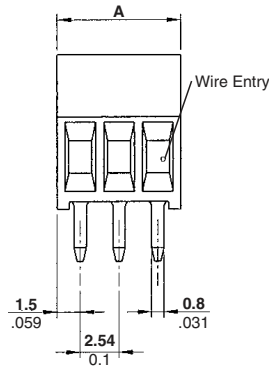
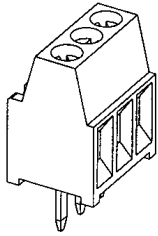

Recommended PC Board Layout

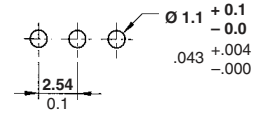

Suggested Screw Torque—
1.73 in.-lbs.

No. of Positions	Dim. A	Part Numbers	
		Green	Gray
2	5.54 [0.218]	282834-2	1546215-2
3	8.08 [0.318]	282834-3	1546215-3
4	10.62 [0.418]	282834-4	1546215-4
5	13.16 [0.518]	282834-5	1546215-5
6	15.70 [0.618]	282834-6	1546215-6
7	18.24 [0.718]	282834-7	1546215-7
8	20.78 [0.818]	282834-8	1546215-8
9	23.32 [0.918]	282834-9	1546215-9
10	25.86 [1.018]	1-282834-0	1-1546215-0
11	28.40 [1.118]	1-282834-1	1-1546215-1
12	30.94 [1.218]	1-282834-2	1-1546215-2

**Board Mount,
5.08 mm Centerline,
Side Wire Entry
Color – Green**
**UL Rating – 300 V, 10 A
16-30 AWG**

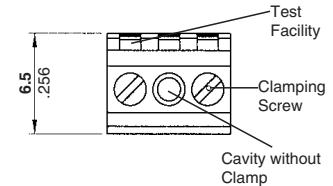
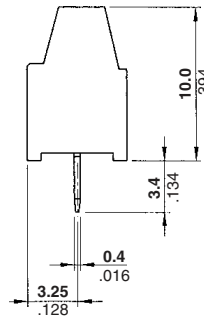
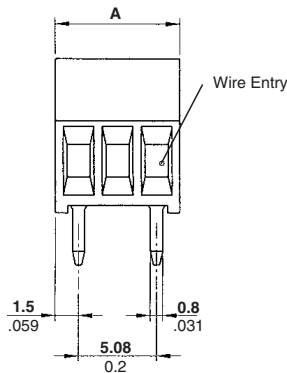
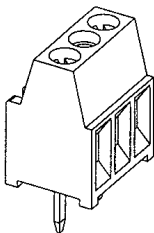

Recommended PC Board Layout

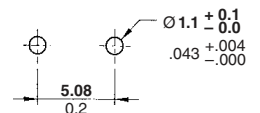

Suggested Screw Torque—
1.73 in.-lbs.

No. of Positions	Dim. A	Part Numbers
2	8.08 [0.318]	282835-2
3	13.16 [0.518]	282835-3
4	18.24 [0.718]	282835-4
5	23.32 [0.918]	282835-5
6	28.40 [1.118]	282835-6

Note: All part numbers are RoHS Compliant.

Board Mount, Side Wire Entry

Board Mount w/Interlock, 3.5 mm Centerline, Side Wire Entry

**UL Rating – 300 V, 12 A
14-30 AWG**

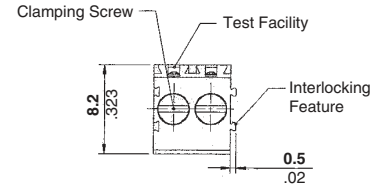
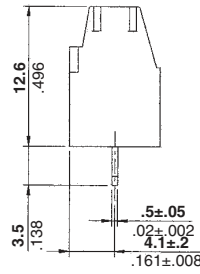
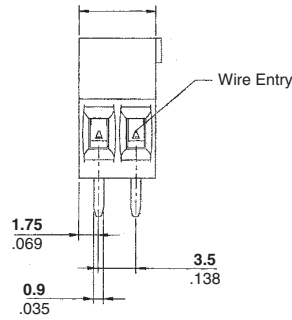
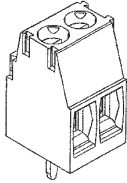

Recommended PC Board Layout

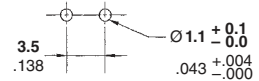

Suggested Screw Torque—
2.2 in.-lbs.

No. of Positions	Dim. A	Part Numbers	
		Green	Blue
2	7.0 [0.276]	284391-2	1546227-2
3	10.5 [0.413]	284391-3	1546227-3
4	14.0 [0.551]	284391-4	1546227-4
5	17.5 [0.689]	284391-5	1546227-5
6	21.0 [0.827]	284391-6	1546227-6
7	24.5 [0.965]	284391-7	1546227-7
8	28.0 [1.102]	284391-8	1546227-8
9	31.5 [1.240]	284391-9	1546227-9
10	35.0 [1.378]	1-284391-0	1-1546227-0
11	38.5 [1.516]	1-284391-1	1-1546227-1
12	42.0 [1.654]	1-284391-2	1-1546227-2
13	45.5 [1.791]	1-284391-3	1-1546227-3

No. of Positions	Dim. A	Part Numbers	
		Green	Blue
14	49.0 [1.929]	1-284391-4	1-1546227-4
15	52.5 [2.067]	1-284391-5	1-1546227-5
16	56.0 [2.205]	1-284391-6	1-1546227-6
17	59.5 [2.343]	1-284391-7	1-1546227-7
18	63.0 [2.480]	1-284391-8	1-1546227-8
19	66.5 [2.618]	1-284391-9	1-1546227-9
20	70.0 [2.756]	2-284391-0	2-1546227-0
21	73.5 [2.894]	2-284391-1	2-1546227-1
22	77.0 [3.031]	2-284391-2	2-1546227-2
23	80.5 [3.169]	2-284391-3	2-1546227-3
24	84.0 [3.307]	2-284391-4	2-1546227-4
25	87.5 [3.445]	2-284391-5	2-1546227-5

Board Mount 3.5 mm Centerline, Side Wire Entry

**UL Rating – 300 V, 12 A
16-28 AWG**

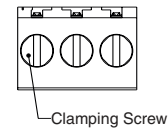
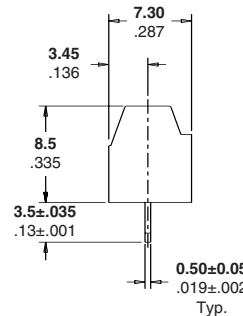
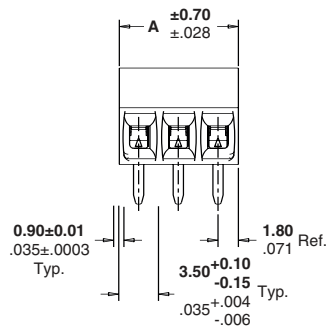
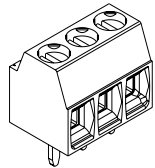

Recommended PC Board Layout

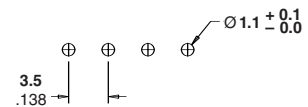

No. of Positions	Dim. A	Part Numbers	
		Black*	Green
2	7.00 [276]	1776112-2	1546551-2
3	10.50 [413]	1776112-3	1546551-3
4	14.00 [551]	1776112-4	1546551-4
5	17.50 [689]	—	1546551-5
6	21.00 [827]	—	1546551-6
7	24.50 [965]	—	1546551-7
8	28.00 [1.102]	—	1546551-8
9	31.50 [1.240]	—	1546551-9
10	35.00 [1.378]	—	1-1546551-0
11	38.50 [1.516]	—	1-1546551-1
12	42.00 [1.654]	—	1-1546551-2
13	45.50 [1.791]	—	1-1546551-3

No. of Positions	Dim. A	Part Numbers	
		Black*	Green
14	49.00 [1.929]	—	1-1546551-4
15	52.50 [2.067]	—	1-1546551-5
16	56.00 [2.205]	—	1-1546551-6
17	59.50 [2.343]	—	1-1546551-7
18	63.00 [2.480]	—	1-1546551-8
19	66.50 [2.618]	—	1-1546551-9
20	70.00 [2.756]	—	2-1546551-0
21	73.50 [2.894]	—	2-1546551-1
22	77.00 [3.031]	—	2-1546551-2
23	80.50 [3.169]	—	2-1546551-3
24	84.00 [3.307]	—	2-1546551-4
25	87.50 [3.445]	—	2-1546551-5

*Wave solder process capable to 265°C [509°F] for 10 seconds

Note: All part numbers are RoHS Compliant.

Board Mount, Side Wire Entry (Continued)

**Board Mount w/Interlock,
3.81 mm Centerline,
Side Wire Entry
Color – Green**

**UL Rating – 300 V, 12 A
14-30 AWG**

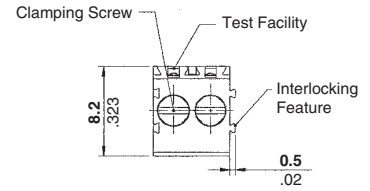
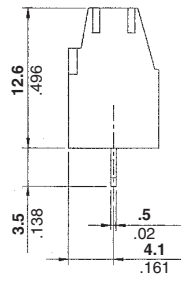
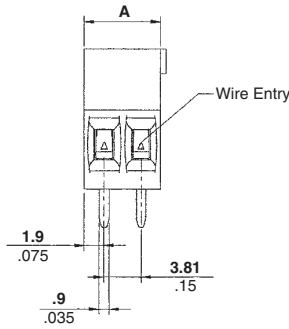
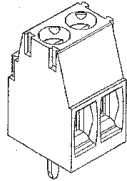

Recommended PC Board Layout

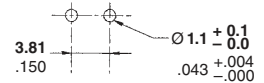

**Suggested Screw Torque—
2.2 in.-lbs.**

No. of Positions	Dim. A	Part Numbers
2	7.62 [0.300]	284392-2
3	11.43 [0.450]	284392-3
4	15.24 [0.600]	284392-4
5	19.05 [0.750]	284392-5
6	22.86 [0.900]	284392-6
7	26.67 [1.050]	284392-7
8	30.48 [1.200]	284392-8
9	34.29 [1.350]	284392-9
10	38.10 [1.500]	1-284392-0
11	41.91 [1.650]	1-284392-1
12	45.72 [1.800]	1-284392-2
13	49.53 [1.950]	1-284392-3

No. of Positions	Dim. A	Part Numbers
14	53.34 [2.100]	1-284392-4
15	57.15 [2.250]	1-284392-5
16	60.96 [2.400]	1-284392-6
17	64.77 [2.550]	1-284392-7
18	68.58 [2.700]	1-284392-8
19	72.39 [2.850]	1-284392-9
20	76.20 [3.000]	2-284392-0
21	80.01 [3.150]	2-284392-1
22	83.82 [3.300]	2-284392-2
23	87.63 [3.450]	2-284392-3
24	91.44 [3.600]	2-284392-4
25	95.25 [3.750]	2-284392-5

**Board Mount,
3.81 mm Centerline,
Side Wire Entry**

**UL Rating – 150 V, 12 A
16-28 AWG**

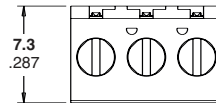
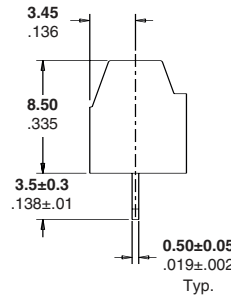
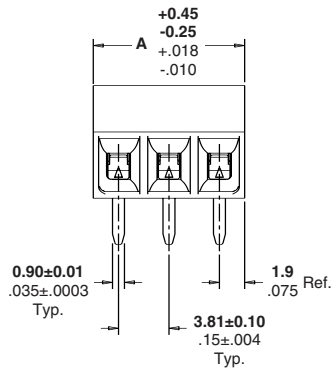
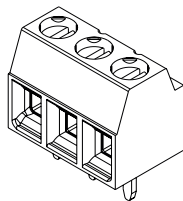

Recommended PC Board Layout

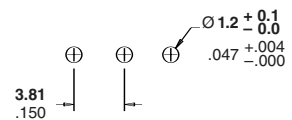

No. of Positions	Dim. A	Part Numbers	
		Black*	Green
2	7.62 [.300]	1776113-2	1546552-2
3	11.43 [.450]	1776113-3	1546552-3
4	15.24 [.600]	1776113-4	1546552-4
5	19.05 [.750]	1776113-5	1546552-5
6	22.86 [.900]	1776113-6	1546552-6
7	26.67 [1.050]	1776113-7	1546552-7
8	30.48 [1.200]	1776113-8	1546552-8
9	34.29 [1.350]	1776113-9	1546552-9
10	38.10 [1.500]	1-1776113-0	1-1546552-0
11	41.91 [1.650]	1-1776113-1	1-1546552-1
12	45.72 [1.800]	1-1776113-2	1-1546552-2
13	49.53 [1.950]	—	1-1546552-3

No. of Positions	Dim. A	Part Numbers	
		Black*	Green
14	53.34 [2.100]	—	1-1546552-4
15	57.15 [2.250]	—	1-1546552-5
16	60.96 [2.400]	—	1-1546552-6
17	64.77 [2.550]	—	1-1546552-7
18	68.58 [2.700]	—	1-1546552-8
19	72.39 [2.850]	—	1-1546552-9
20	76.20 [3.000]	—	2-1546552-0
21	80.01 [3.150]	—	2-1546552-1
22	83.82 [3.300]	—	2-1546552-2
23	87.63 [3.450]	—	2-1546552-3
24	91.44 [3.600]	—	2-1546552-4
25	95.25 [3.750]	—	2-1546552-5

*Wave solder process capable to 265°C [509°F] for 10 seconds

Note: All part numbers are RoHS Compliant.

Board Mount, Side Wire Entry (Continued)

Board Mount w/Interlock, Low Profile, 5.0 mm Centerline, Side Wire Entry

**UL Rating – 300 V, 13.5 A
16-30 AWG
10 A for field wiring applications**

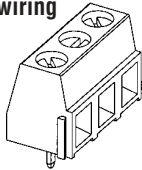

Suggested Screw Torque—
6.0 in.-lbs.

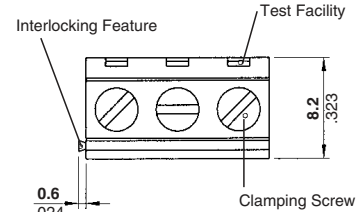
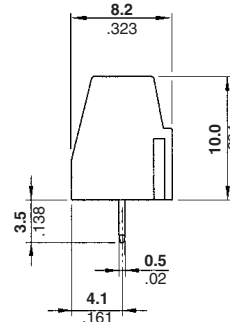
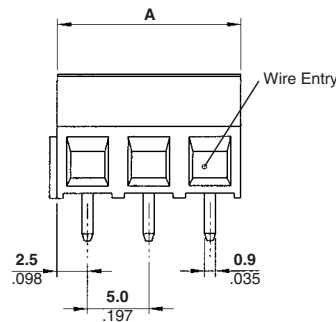

Recommended PC Board Layout

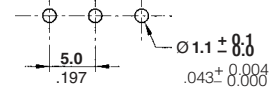

No. of Positions	Dim. A	Part Numbers		
		Green	Gray	Black*
2	10.0 [0.394]	282836-2	1546216-2	1776118-2
3	15.0 [0.591]	282836-3	1546216-3	1776118-3
4	20.0 [0.787]	282836-4	1546216-4	1776118-4
5	25.0 [0.984]	282836-5	1546216-5	1776118-5
6	30.0 [1.181]	282836-6	1546216-6	1776118-6
7	35.0 [1.378]	282836-7	1546216-7	1776118-7
8	40.0 [1.575]	282836-8	1546216-8	1776118-8
9	45.0 [1.772]	282836-9	1546216-9	—
10	50.0 [1.968]	1-282836-0	1-1546216-0	—
11	55.0 [2.165]	1-282836-1	1-1546216-1	—
12	60.0 [2.362]	1-282836-2	1-1546216-2	—
13	65.0 [2.559]	1-282836-4	1-1546216-3	—

No. of Positions	Dim. A	Part Numbers		
		Green	Gray	Black*
14	70.0 [2.756]	1-282836-5	1-1546216-4	—
15	75.0 [2.953]	1-282836-6	1-1546216-5	—
16	80.0 [3.150]	1-282836-7	1-1546216-6	—
17	85.0 [3.346]	1-282836-8	1-1546216-7	—
18	90.0 [3.543]	1-282836-9	1-1546216-8	—
19	95.0 [3.740]	2-282836-0	1-1546216-9	—
20	100.0 [3.937]	2-282836-1	2-1546216-0	—
21	105.0 [4.134]	2-282836-2	2-1546216-1	—
22	110.0 [4.331]	2-282836-3	2-1546216-2	—
23	115.0 [4.528]	2-282836-4	2-1546216-3	—
24	120.0 [4.724]	2-282836-5	2-1546216-4	—
25	125.0 [4.921]	2-282836-6	2-1546216-5	—

*Wave solder process capable to 265°C [509°F] for 10 seconds

Board Mount w/Interlock, Low Profile, 5.08 mm Centerline, Side Wire Entry

**UL Rating – 300 V, 13.5 A
16-30 AWG
10 A for field wiring applications**

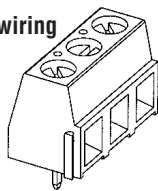

Suggested Screw Torque—
6.0 in.-lbs.

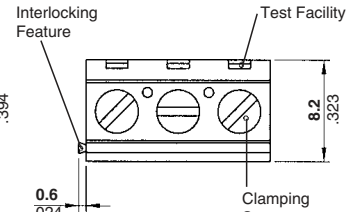
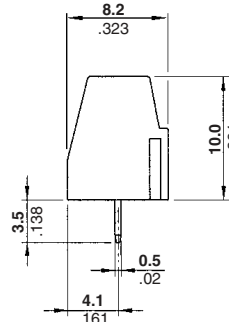
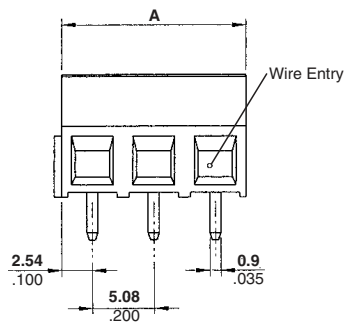

Recommended PC Board Layout

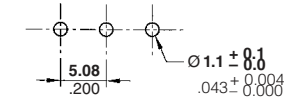

No. of Positions	Dim. A	Part Numbers		
		Green	Gray	Black*
2	10.16 [0.400]	282837-2	1546217-2	1776119-2
3	15.24 [0.600]	282837-3	1546217-3	1776119-3
4	20.32 [0.800]	282837-4	1546217-4	1776119-4
5	25.40 [1.000]	282837-5	1546217-5	1776119-5
6	30.48 [1.200]	282837-6	1546217-6	1776119-6
7	35.56 [1.400]	282837-7	1546217-7	1776119-7
8	40.64 [1.600]	282837-8	1546217-8	1776119-8
9	45.72 [1.800]	282837-9	1546217-9	—
10	50.80 [2.000]	1-282837-0	1-1546217-0	—
11	55.88 [2.200]	1-282837-1	1-1546217-1	—
12	60.96 [2.400]	1-282837-2	1-1546217-2	—
13	66.04 [2.600]	1-282837-6	1-1546217-6	—

No. of Positions	Dim. A	Part Numbers		
		Green	Gray	Black*
14	71.12 [2.800]	1-282837-7	1-1546217-7	—
15	76.20 [3.000]	1-282837-8	1-1546217-8	—
16	81.28 [3.200]	1-282837-9	1-1546217-9	—
17	86.36 [3.400]	2-282837-0	2-1546217-0	—
18	91.44 [3.600]	2-282837-1	2-1546217-1	—
19	96.52 [3.800]	2-282837-2	2-1546217-2	—
20	101.60 [4.000]	2-282837-3	2-1546217-3	—
21	106.68 [4.200]	2-282837-4	2-1546217-4	—
22	111.76 [4.400]	2-282837-5	2-1546217-5	—
23	116.84 [4.600]	2-282837-6	2-1546217-6	—
24	121.92 [4.800]	2-282837-7	2-1546217-7	—
25	127.00 [5.000]	2-282837-8	2-1546217-8	—

*Wave solder process capable to 265°C [509°F] for 10 seconds

Note: All part numbers are RoHS Compliant.

Board Mount, Side Wire Entry (Continued)

**Board Mount w/Interlock,
5.0 mm Centerline,
Side Wire Entry**

**UL Rating – 300 V, 17.5 A
12-30 AWG
15 A for field wiring applications**

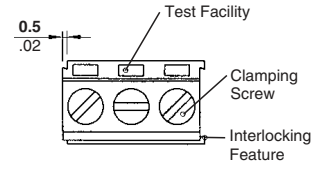
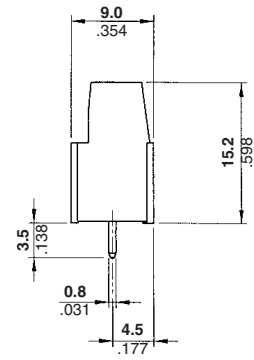
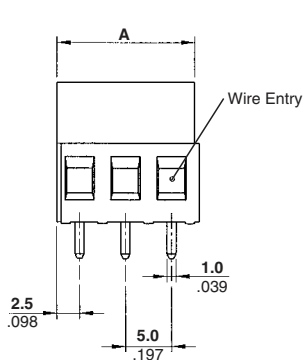
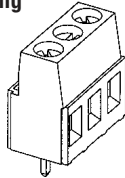

Recommended PC Board Layout

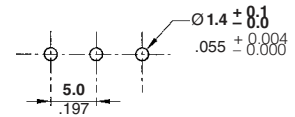

**Suggested Screw Torque—
7.0 in.-lbs.**

No. of Positions	Dim. A	Part Numbers		
		Green	Blue	Black
2	10.0 [0.394]	796683-2	796681-2	796682-2
3	15.0 [0.591]	796683-3	796681-3	796682-3
4	20.0 [0.787]	796683-4	796681-4	796682-4
5	25.0 [0.984]	796683-5	796681-5	796682-5
6	30.0 [1.181]	796683-6	796681-6	796682-6
7	35.0 [1.378]	796683-7	796681-7	796682-7
8	40.0 [1.575]	796683-8	796681-8	796682-8
9	45.0 [1.772]	796683-9	796681-9	796682-9
10	50.0 [1.968]	1-796683-0	1-796681-0	1-796682-0
11	55.0 [2.165]	1-796683-1	1-796681-1	1-796682-1
12	60.0 [2.362]	1-796683-2	1-796681-2	1-796682-2
13	65.0 [2.559]	1-796683-3	1-796681-3	1-796682-3

No. of Positions	Dim. A	Part Numbers		
		Green	Blue	Black
14	70.0 [2.756]	1-796683-4	1-796681-4	1-796682-4
15	75.0 [2.953]	1-796683-5	1-796681-5	1-796682-5
16	80.0 [3.150]	1-796683-6	1-796681-6	1-796682-6
17	85.0 [3.346]	1-796683-7	1-796681-7	1-796682-7
18	90.0 [3.543]	1-796683-8	1-796681-8	1-796682-8
19	95.0 [3.740]	1-796683-9	1-796681-9	1-796682-9
20	100.0 [3.937]	2-796683-0	2-796681-0	2-796682-0
21	105.0 [4.134]	2-796683-1	2-796681-1	2-796682-1
22	110.0 [4.331]	2-796683-2	2-796681-2	2-796682-2
23	115.0 [4.528]	2-796683-3	2-796681-3	2-796682-3
24	120.0 [4.724]	2-796683-4	2-796681-4	2-796682-4
25	125.0 [4.921]	2-796683-5	2-796681-5	2-796682-5

Note: BUCHANAN Terminal Block Series B02C4VxxT has been superceded/replaced with 796681-x.
RDI Terminal Block Series 5KEV-xx has been superceded/replaced with 796683-x (green) or 796682-x (black).

**Board Mount w/Interlock,
5.0 mm Centerline,
Side Wire Entry
Color – Green**

**UL Rating – 300 V, 24 A
12-30 AWG
20 A for field wiring applications**

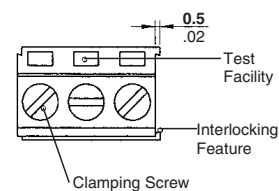
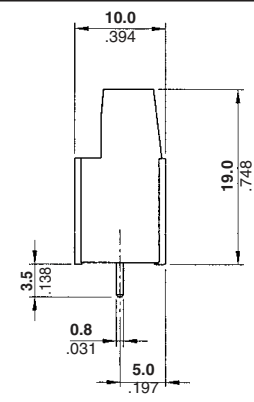
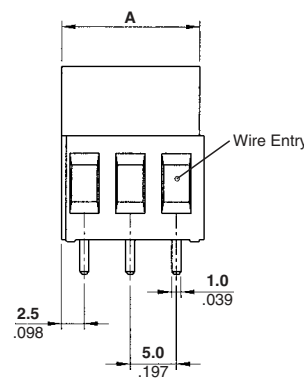
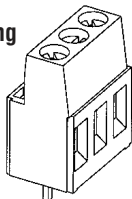

Recommended PC Board Layout

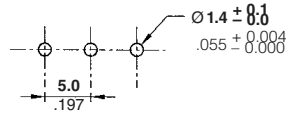

**Suggested Screw Torque—
7.0 in.-lbs.**

No. of Positions	Dim. A	Part Number
2	10.0 [.394]	282856-2
3	15.0 [.591]	282856-3
4	20.0 [.787]	282856-4
5	25.0 [.984]	282856-5
6	30.0 [1.181]	282856-6
7	35.0 [1.378]	282856-7
8	40.0 [1.575]	282856-8
9	45.0 [1.772]	282856-9
10	50.0 [1.968]	1-282856-0
11	55.0 [2.165]	1-282856-1
12	60.0 [2.362]	1-282856-2
13	65.0 [2.559]	1-282856-3

No. of Positions	Dim. A	Part Number
14	70.0 [2.756]	1-282856-5
15	75.0 [2.953]	1-282856-6
16	80.0 [3.150]	1-282856-7
17	85.0 [3.346]	1-282856-8
18	90.0 [3.543]	1-282856-9
19	95.0 [3.740]	2-282856-0
20	100.0 [3.937]	2-282856-1
21	105.0 [4.134]	2-282856-2
22	110.0 [4.331]	2-282856-3
23	115.0 [4.528]	2-282856-4
24	120.0 [4.724]	2-282856-5
25	125.0 [4.921]	2-282856-6

Note: All part numbers are RoHS Compliant.

Board Mount, Side Wire Entry (Continued)

**Board Mount w/Interlock,
5.08 mm Centerline,
Side Wire Entry**

**UL Rating – 300 V, 17.5 A
12-30 AWG
15 A for field wiring
applications**

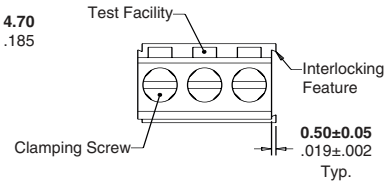
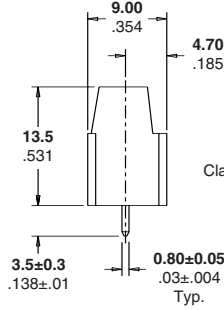
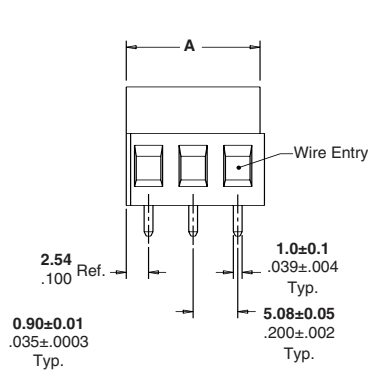
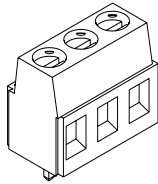

Recommended PC Board Layout

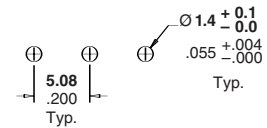

No. of Positions	Dim. A	Part Numbers	
		Black*	Green
2	10.16 [0.400]	1776126-2	796911-2
3	15.24 [0.600]	1776126-3	796911-3
4	20.32 [0.800]	—	796911-4
5	25.40 [1.000]	—	796911-5
6	30.48 [1.200]	—	796911-6
7	35.56 [1.400]	—	796911-7
8	40.64 [1.600]	—	796911-8
9	45.72 [1.800]	—	796911-9
10	50.80 [2.000]	—	1-796911-0
11	55.88 [2.200]	—	1-796911-1
12	60.96 [2.400]	—	1-796911-2
13	66.04 [2.600]	—	1-796911-3

No. of Positions	Dim. A	Part Numbers	
		Black*	Green
14	71.12 [2.800]	—	1-796911-4
15	76.20 [3.000]	—	1-796911-5
16	81.28 [3.200]	—	1-796911-6
17	86.36 [3.400]	—	1-796911-7
18	91.44 [3.600]	—	1-796911-8
19	96.52 [3.800]	—	1-796911-9
20	101.60 [4.000]	—	2-796911-0
21	106.68 [4.200]	—	2-796911-1
22	111.76 [4.400]	—	2-796911-2
23	116.84 [4.600]	—	2-796911-3
24	121.92 [4.800]	—	2-796911-4
25	127.00 [5.000]	—	2-796911-5

*Wave solder process capable to 265°C [509°F] for 10 seconds

**Board Mount w/Interlock,
5.08 mm Centerline,
Side Wire Entry**

**UL Rating – 300 V, 17.5 A
12-30 AWG
15 A for field wiring
applications**

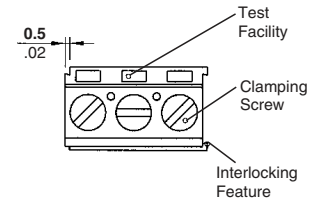
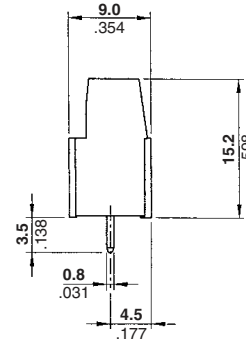
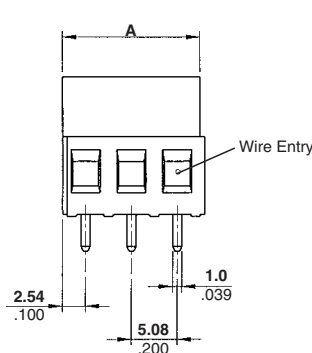
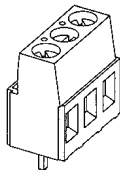

Recommended PC Board Layout

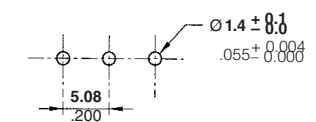

Suggested Screw Torque—
7.0 in.-lbs.

No. of Positions	Dim. A	Part Numbers		
		Green	Black	Gray
2	10.16 [0.400]	282841-2	796949-2	1546218-2
3	15.24 [0.600]	282841-3	796949-3	1546218-3
4	20.32 [0.800]	282841-4	796949-4	1546218-4
5	25.40 [1.000]	282841-5	796949-5	1546218-5
6	30.48 [1.200]	282841-6	796949-6	1546218-6
7	35.56 [1.400]	282841-7	796949-7	1546218-7
8	40.64 [1.600]	282841-8	796949-8	1546218-8
9	45.72 [1.800]	282841-9	796949-9	1546218-9
10	50.80 [2.000]	1-282841-0	1-796949-0	1-1546218-0
11	55.88 [2.200]	1-282841-1	1-796949-1	1-1546218-1
12	60.96 [2.400]	1-282841-2	1-796949-2	1-1546218-2
13	66.04 [2.600]	1-282841-6	1-796949-3	1-1546218-3

No. of Positions	Dim. A	Part Numbers		
		Green	Black	Gray
14	71.12 [2.800]	1-282841-7	1-796949-4	1-1546218-4
15	76.20 [3.000]	1-282841-8	1-796949-5	1-1546218-5
16	81.28 [3.200]	1-282841-9	1-796949-6	1-1546218-6
17	86.36 [3.400]	2-282841-0	1-796949-7	1-1546218-7
18	91.44 [3.600]	2-282841-1	1-796949-8	1-1546218-8
19	96.52 [3.800]	2-282841-2	1-796949-9	1-1546218-9
20	101.60 [4.000]	2-282841-3	2-796949-0	2-1546218-0
21	106.68 [4.200]	2-282841-4	2-796949-1	2-1546218-1
22	111.76 [4.400]	2-282841-5	2-796949-2	2-1546218-2
23	116.84 [4.600]	2-282841-6	2-796949-3	2-1546218-3
24	121.92 [4.800]	2-282841-7	2-796949-4	2-1546218-4
25	127.00 [5.000]	2-282841-8	2-796949-5	2-1546218-5



Note: All part numbers are RoHS Compliant.

Board Mount, Side Wire Entry (Continued)

Board Mount w/Interlock, 5.08 mm Centerline, Side Wire Entry
Color – Green

UL Rating – 300 V, 24 A
12-30 AWG
20 A for field wiring applications

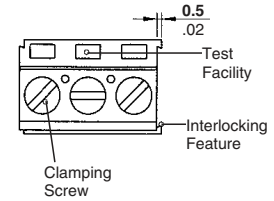
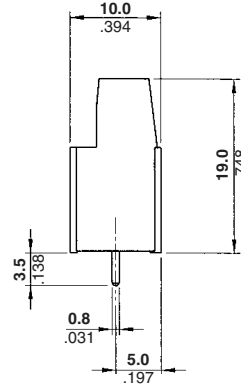
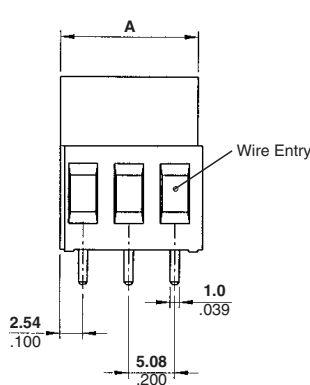
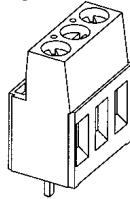

Recommended PC Board Layout

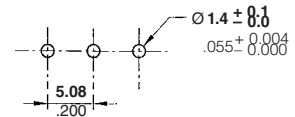

Suggested Screw Torque—
7.0 in.-lbs.

No. of Positions	Dim. A	Part Numbers
2	10.16 [0.400]	282857-2
3	15.24 [0.600]	282857-3
4	20.32 [0.800]	282857-4
5	25.40 [1.000]	282857-5
6	30.48 [1.200]	282857-6
7	35.56 [1.400]	282857-7
8	40.64 [1.600]	282857-8
9	45.72 [1.800]	282857-9
10	50.80 [2.000]	1-282857-0
11	55.88 [2.200]	1-282857-1
12	60.96 [2.400]	1-282857-2
13	66.04 [2.600]	1-282857-3

No. of Positions	Dim. A	Part Numbers
14	71.12 [2.800]	1-282857-4
15	76.20 [3.000]	1-282857-5
16	81.28 [3.200]	1-282857-6
17	86.36 [3.400]	1-282857-7
18	91.44 [3.600]	1-282857-8
19	96.52 [3.800]	1-282857-9
20	101.60 [4.000]	2-282857-0
21	106.68 [4.200]	2-282857-1
22	111.76 [4.400]	2-282857-2
23	116.84 [4.600]	2-282857-3
24	121.92 [4.800]	2-282857-4
25	127.00 [5.000]	2-282857-5

Board Mount w/Interlock, 7.5 mm Centerline, Side Wire Entry
Color – Green

UL Rating – 300 V, 17.5 A
12-30 AWG
15 A for field wiring applications

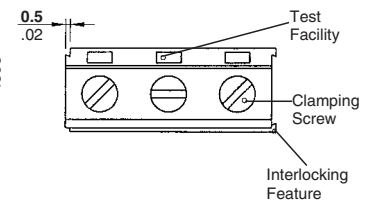
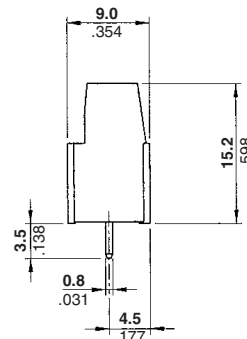
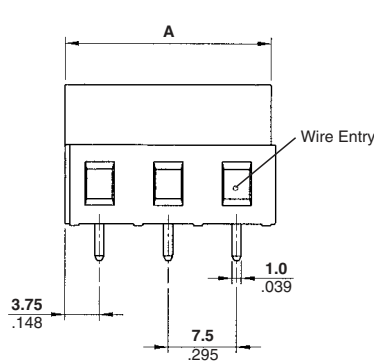
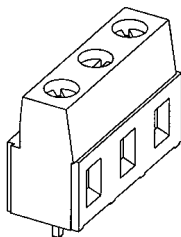

Recommended PC Board Layout

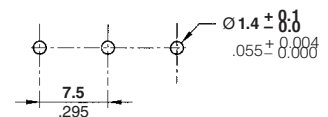

Suggested Screw Torque—
7.0 in.-lbs.

No. of Positions	Dim. A	Part Numbers
2	15.0 [0.591]	282844-2
3	22.5 [0.886]	282844-3
4	30.0 [1.181]	282844-4

Note: All part numbers are RoHS Compliant.

Board Mount, Side Wire Entry (Continued)

Board Mount w/Interlock, 7.5 mm Centerline, Side Wire Entry
UL Rating – 300 V, 24 A
12-30 AWG
20 A for field wiring applications

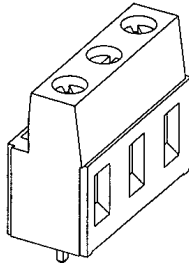

Suggested Screw Torque—
 7.0 in.-lbs.

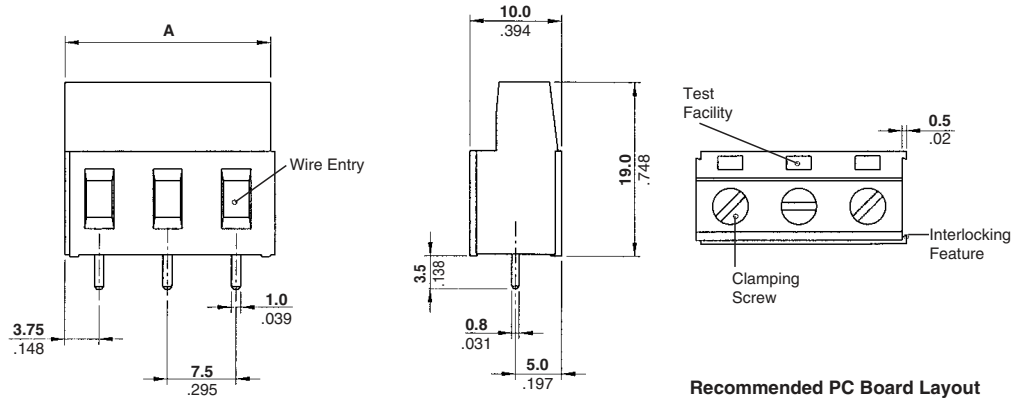

Recommended PC Board Layout

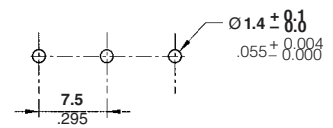

No. of Positions	Dim. A	Part Numbers	
		Green	Black
2	15.0 [0.591]	282860-2	1546062-2
3	22.5 [0.886]	282860-3	1546062-3
4	30.0 [1.181]	282860-4	1546062-4

Board Mount w/Interlock, 7.62 mm Centerline, Side Wire Entry
Color – Green
UL Rating – 300 V, 17.5 A
12-30 AWG
15 A for field wiring applications

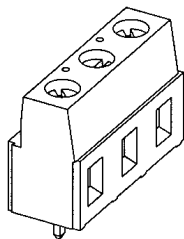

Suggested Screw Torque—
 7.0 in.-lbs.

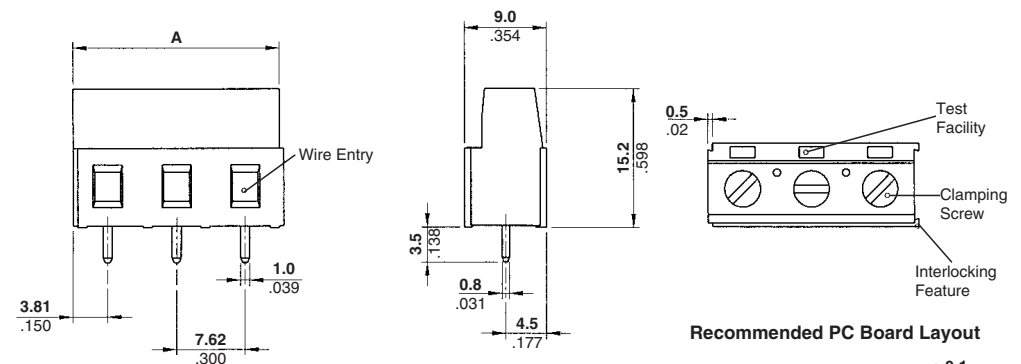

Recommended PC Board Layout

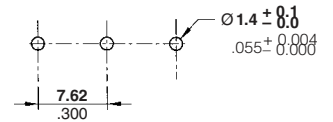

No. of Positions	Dim. A	Part Numbers
2	15.24 [.600]	282845-2
3	22.86 [.900]	282845-3

Note: All part numbers are RoHS Compliant.

Board Mount, Side Wire Entry (Continued)

Board Mount w/Interlock, 7.62 mm Centerline, Side Wire Entry
Color – Green

UL Rating – 300 V, 24 A
12-30 AWG
20 A for field wiring applications

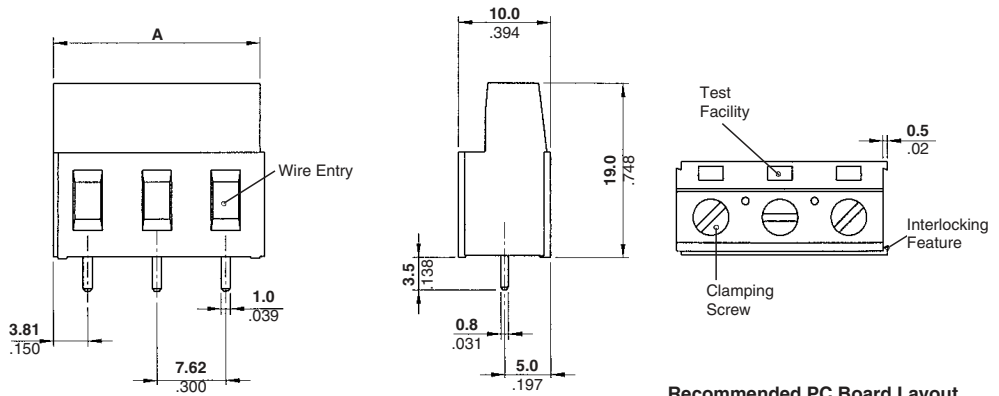
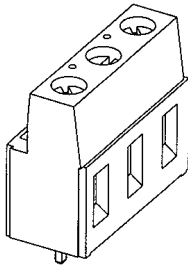

Recommended PC Board Layout

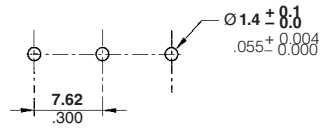

Suggested Screw Torque—
7.0 in.-lbs.

No. of Positions	Dim. A	Part Numbers
2	15.24 [.600]	282861-2
3	22.86 [.900]	282861-3

Board Mount, Low Profile, 10.0 mm Centerline, Side Wire Entry

UL Rating – 600 V, 13.5 A
16-30 AWG
10 A for field wiring applications

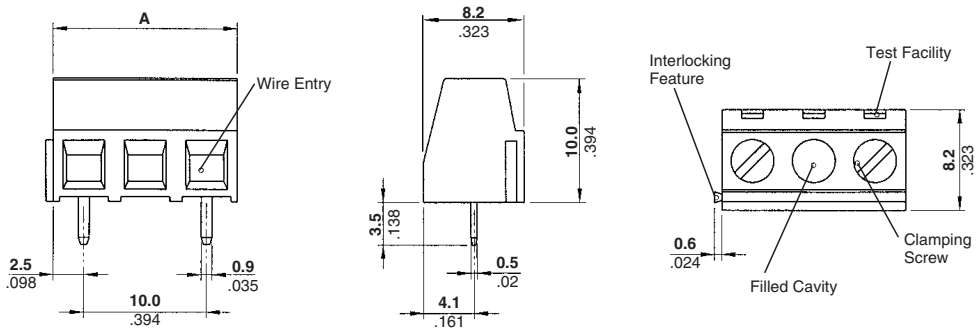
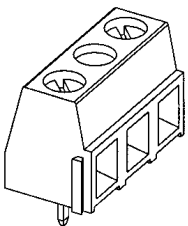

Recommended PC Board Layout

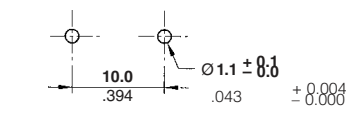

Suggested Screw Torque—
6.0 in.-lbs.

No. of Positions	Dim. A	Part Numbers	
		Green	Black*
2	15.0 [0.591]	282838-2	1776112-2
3	25.0 [0.984]	282838-3	1776112-3
4	35.0 [1.378]	282838-4	1776112-4
5	45.0 [1.772]	282838-5	—
6	55.0 [2.165]	282838-6	—
7	65.0 [2.559]	282838-8	—
8	75.0 [2.953]	282838-9	—
9	85.0 [3.346]	1-282838-0	—
10	95.0 [3.740]	1-282838-1	—
11	105.0 [4.134]	1-282838-2	—
12	115.0 [4.528]	1-282838-3	—
13	125.0 [4.921]	1-282838-4	—

*Wave solder process capable to 265°C [509°F] for 10 seconds

Note: All part numbers are RoHS Compliant.

Board Mount, Side Wire Entry (Continued)

Board Mount
10.0 mm Centerline,
Side Wire Entry
Color – Green
UL Rating – 600 V, 17.5 A
12-30 AWG
15 A for field wiring applications

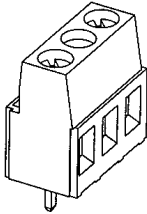

Suggested Screw Torque—
 7.0 in.-lbs.

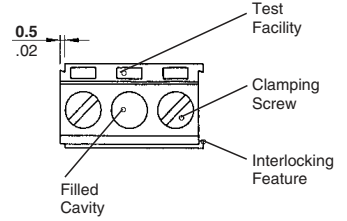
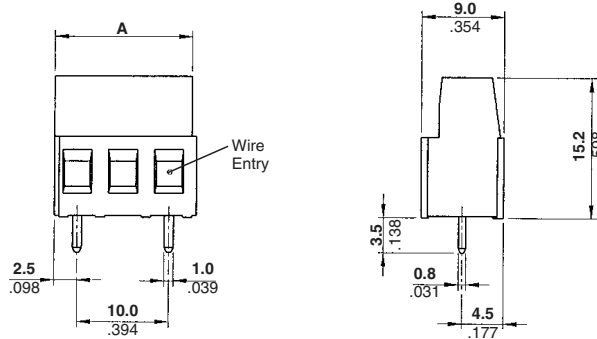

Recommended PC Board Layout

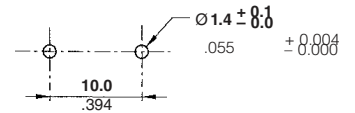

No. of Positions	Dim. A	Part Numbers
2	15.0 [0.591]	282842-2
3	25.0 [0.984]	282842-3
4	35.0 [1.378]	282842-4
5	45.0 [1.772]	282842-5
6	55.0 [2.165]	282842-6
7	65.0 [2.559]	282842-7
8	75.0 [2.953]	282842-8
9	85.0 [3.346]	282842-9
10	95.0 [3.740]	1-282842-0
11	105.0 [4.134]	1-282842-1
12	115.0 [4.528]	1-282842-2
13	125.0 [4.921]	1-282842-3

Board Mount
10.0 mm Centerline,
Side Wire Entry
Color – See Chart
UL Rating – 600 V, 24 A
12-30 AWG
20 A for field wiring applications

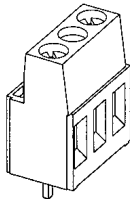

Suggested Screw Torque—
 7.0 in.-lbs.

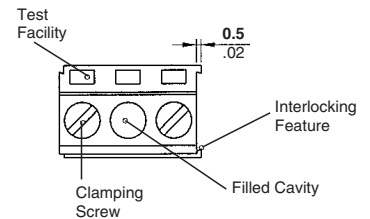
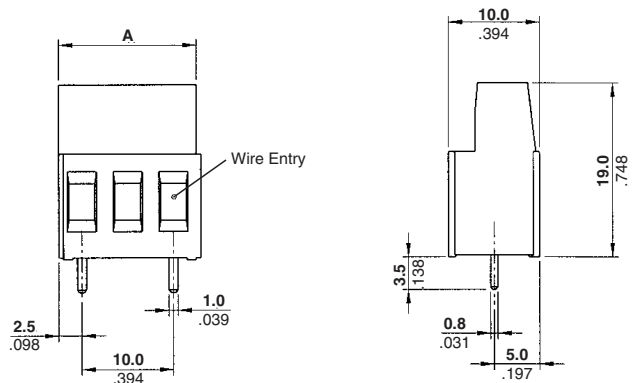

Recommended PC Board Layout

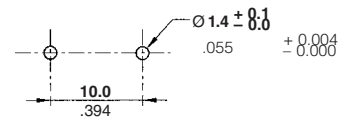

No. of Positions	Dim. A	Part Numbers	
		Green	Blue
2	15.0 [0.591]	282858-2	796704-2
3	25.0 [0.984]	282858-3	796704-3
4	35.0 [1.378]	282858-4	796704-4
5	45.0 [1.772]	282858-5	796704-5
6	55.0 [2.165]	282858-6	796704-6
7	65.0 [2.559]	282858-7	796704-7

No. of Positions	Dim. A	Part Numbers	
		Green	Blue
8	75.0 [2.953]	282858-8	796704-8
9	85.0 [3.346]	282858-9	796704-9
10	95.0 [3.740]	1-282858-0	1-796704-0
11	105.0 [4.134]	1-282858-1	1-796704-1
12	115.0 [4.528]	1-282858-2	1-796704-2
13	125.0 [4.921]	1-282858-3	1-796704-3

Note: BUCHANAN Terminal Block Series B03C5VxxT has been superseded/replaced with 796704-x.

Note: All part numbers are RoHS Compliant.

Board Mount, Side Wire Entry (Continued)

Board Mount w/Interlock, Low Profile, 10.16 mm Centerline, Side Wire Entry

**UL Rating – 300 V, 13.5 A
16-30 AWG
15 A for field wiring applications**

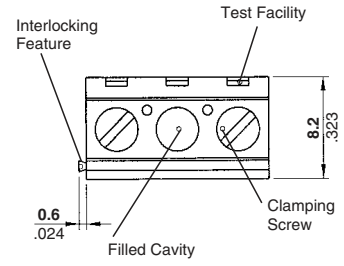
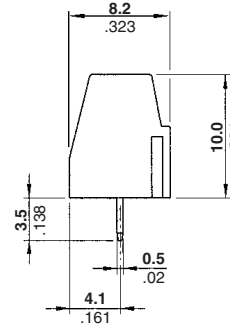
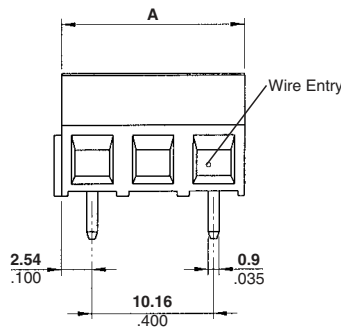
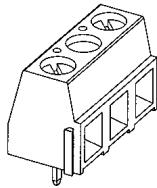

Recommended PC Board Layout

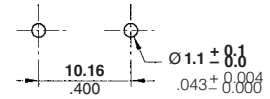

Suggested Screw Torque—
6.0 in.-lbs.

No. of Positions	Dim. A	Part Numbers	
		Green	Black*
2	15.24 [0.600]	282839-2	1776123-2
3	25.40 [1.000]	282839-3	1776123-3
4	35.56 [1.400]	282839-4	1776123-4
5	45.72 [1.800]	282839-5	—
6	55.88 [2.200]	282839-6	—
7	66.04 [2.600]	282839-7	—

*Wave solder process capable to 265°C [509°F] for 10 seconds

No. of Positions	Dim. A	Part Numbers	
		Green	Black*
8	76.20 [3.000]	282839-8	—
9	86.36 [3.400]	282839-9	—
10	96.52 [3.800]	1-282839-0	—
11	106.68 [4.200]	1-282839-1	—
12	116.84 [4.600]	1-282839-2	—
13	127.00 [5.000]	1-282839-3	—

**Board Mount
10.16 mm Centerline,
Side Wire Entry
Color – Green**

**UL Rating – 600 V, 17.5 A
12-30 AWG
15 A for field wiring applications**

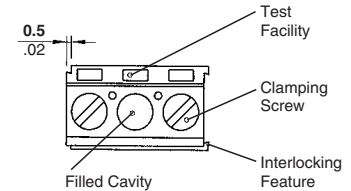
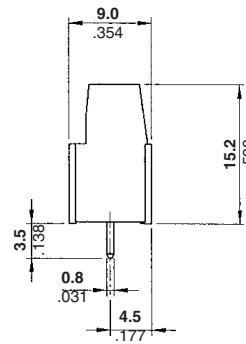
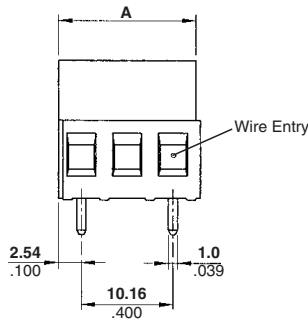
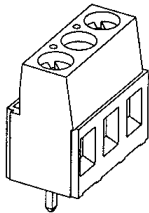

Recommended PC Board Layout

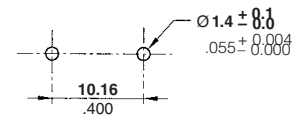

Suggested Screw Torque—
7.0 in.-lbs.

No. of Positions	Dim. A	Part Numbers
2	15.24 [0.600]	282843-2
3	25.40 [1.000]	282843-3
4	35.56 [1.400]	282843-4
5	45.72 [1.800]	282843-5
6	55.88 [2.200]	282843-6
7	66.04 [2.600]	282843-7

No. of Positions	Dim. A	Part Numbers
8	76.20 [3.000]	282843-8
9	86.36 [3.400]	282843-9
10	96.52 [3.800]	1-282843-0
11	106.68 [4.200]	1-282843-1
12	116.84 [4.600]	1-282843-2
13	127.00 [5.000]	1-282843-3

Note: All part numbers are RoHS Compliant.

Board Mount, Top Wire Entry

Board Mount w/Interlock, 3.5 mm Centerline, Top Wire Entry, Color – Green

UL Rating – 300 V, 12 A 14-30 AWG

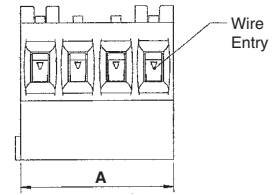
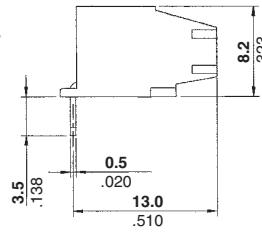
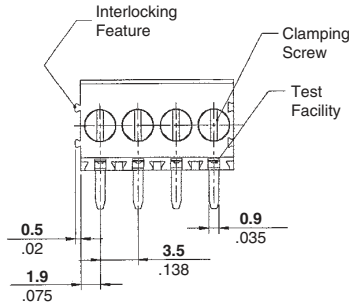
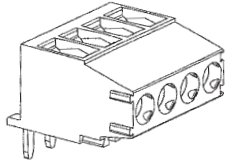

Recommended PC Board Layout

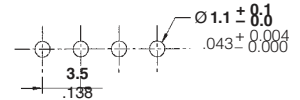

Suggested Screw Torque—
2.2 in.-lbs.

No. of Positions	Dim. A	Part Numbers
2	7.0 [0.276]	284414-2
3	10.5 [0.413]	284414-3
4	14.0 [0.551]	284414-4
5	17.5 [0.689]	284414-5
6	21.0 [0.827]	284414-6
7	24.5 [0.965]	284414-7
8	28.0 [1.102]	284414-8
9	31.5 [1.240]	284414-9
10	35.0 [1.378]	1-284414-0
11	38.5 [1.516]	1-284414-1
12	42.0 [1.654]	1-284414-2
13	45.5 [1.791]	1-284414-3

No. of Positions	Dim. A	Part Numbers
14	49.0 [1.929]	1-284414-4
15	52.5 [2.067]	1-284414-5
16	56.0 [2.205]	1-284414-6
17	59.5 [2.343]	1-284414-7
18	63.0 [2.480]	1-284414-8
19	66.5 [2.618]	1-284414-9
20	70.0 [2.756]	2-284414-0
21	73.5 [2.894]	2-284414-1
22	77.0 [3.031]	2-284414-2
23	80.5 [3.169]	2-284414-3
24	84.0 [3.307]	2-284414-4
25	87.5 [3.445]	2-284414-5

Board Mount w/Interlock, 3.81 mm Centerline, Top Wire Entry, Color – Green

UL Rating – 300 V, 12 A 14-30 AWG

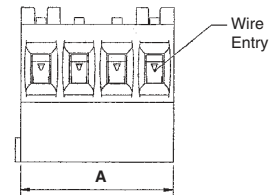
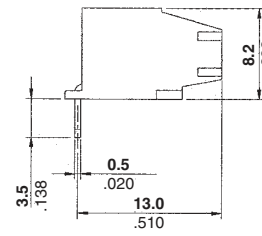
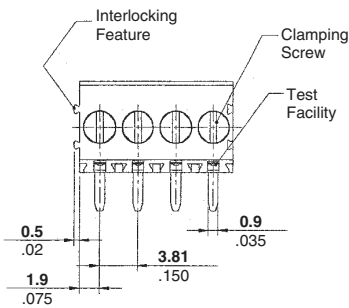
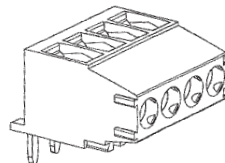

Recommended PC Board Layout

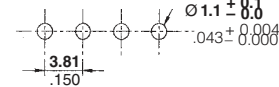

Suggested Screw Torque—
2.2 in.-lbs.

No. of Positions	Dim. A	Part Numbers
2	7.62 [0.300]	284415-2
3	11.43 [0.450]	284415-3
4	15.24 [0.600]	284415-4
5	19.05 [0.750]	284415-5
6	22.86 [0.900]	284415-6
7	26.67 [1.050]	284415-7
8	30.48 [1.200]	284415-8
9	34.29 [1.350]	284415-9
10	38.10 [1.500]	1-284415-0
11	41.91 [1.650]	1-284415-1
12	45.72 [1.800]	1-284415-2
13	49.53 [1.950]	1-284415-3

No. of Positions	Dim. A	Part Numbers
14	53.34 [2.100]	1-284415-4
15	57.15 [2.250]	1-284415-5
16	60.96 [2.400]	1-284415-6
17	64.77 [2.550]	1-284415-7
18	68.58 [2.700]	1-284415-8
19	72.39 [2.850]	1-284415-9
20	76.20 [3.000]	2-284415-0
21	80.01 [3.150]	2-284415-1
22	83.82 [3.300]	2-284415-2
23	87.63 [3.450]	2-284415-3
24	91.44 [3.600]	2-284415-4
25	95.25 [3.750]	2-284415-5



Note: All part numbers are RoHS Compliant.

Board Mount, Top Wire Entry (Continued)

**Board Mount, Low Profile
5.0 mm Centerline,
Top Wire Entry**
**UL Rating – 300 V, 13.5 A
16-30 AWG
10 A for field wiring applications**

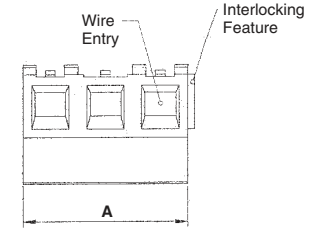
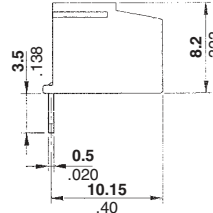
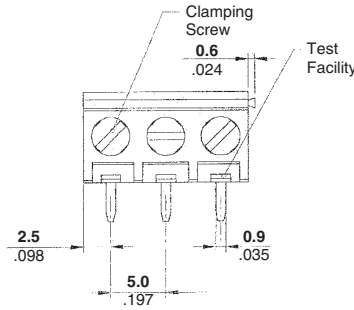
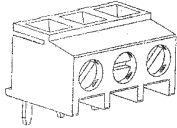

Recommended PC Board Layout

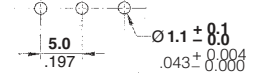

Suggested Screw Torque—
6.0 in.-lbs.

No. of Positions	Dim. A	Part Numbers		
		Green	Gray	Black*
2	10.0 [0.394]	284093-2	1546225-2	1776120-2
3	15.0 [0.591]	284093-3	1546225-3	1776120-3
4	20.0 [0.787]	284093-4	1546225-4	1776120-4
5	25.0 [0.984]	284093-5	1546225-5	1776120-5
6	30.0 [1.181]	284093-6	1546225-6	1776120-6
7	35.0 [1.378]	284093-7	1546225-7	1776120-7
8	40.0 [1.575]	284093-8	1546225-8	1776120-8
9	45.0 [1.772]	284093-9	1546225-9	—
10	50.0 [1.968]	1-284093-0	1-1546225-0	—
11	55.0 [2.165]	1-284093-1	1-1546225-1	—
12	60.0 [2.362]	1-284093-2	1-1546225-2	—
13	65.0 [2.559]	1-284093-3	1-1546225-3	—

No. of Positions	Dim. A	Part Numbers		
		Green	Gray	Black*
14	70.0 [2.756]	1-284093-4	1-1546225-4	—
15	75.0 [2.953]	1-284093-5	1-1546225-5	—
16	80.0 [3.150]	1-284093-6	1-1546225-6	—
17	85.0 [3.346]	1-284093-7	1-1546225-7	—
18	90.0 [3.543]	1-284093-8	1-1546225-8	—
19	95.0 [3.740]	1-284093-9	1-1546225-9	—
20	100.0 [3.937]	2-284093-0	2-1546225-0	—
21	105.0 [4.134]	2-284093-1	2-1546225-1	—
22	110.0 [4.331]	2-284093-2	2-1546225-2	—
23	115.0 [4.528]	2-284093-3	2-1546225-3	—
24	120.0 [4.724]	2-284093-4	2-1546225-4	—
25	125.0 [4.921]	2-284093-5	2-1546225-5	—

*Wave solder process capable to 265°C [509°F] for 10 seconds

**Board Mount w/Interlock,
5.0 mm Centerline,
Top Wire Entry**
**UL Rating – 300 V, 17.5 A
12-30 AWG
15 A for field wiring applications**

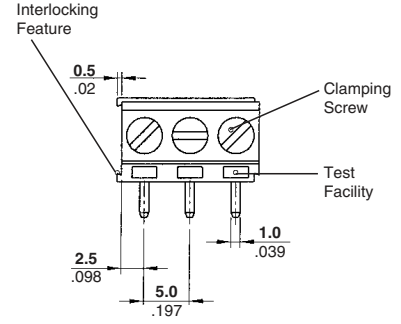
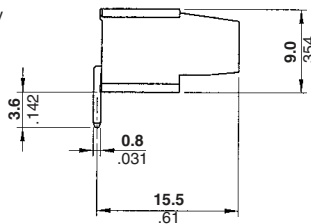
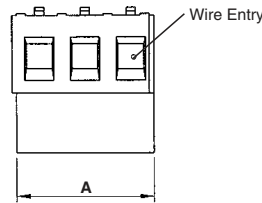
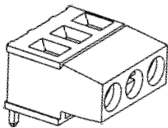

Recommended PC Board Layout

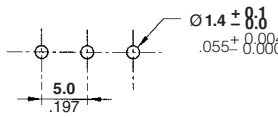

Suggested Screw Torque—
7.0 in.-lbs.

No. of Positions	Dim. A	Part Numbers	
		Green	Blue
2	10.0 [0.394]	796748-2	796684-2
3	15.0 [0.591]	796748-3	796684-3
4	20.0 [0.787]	796748-4	796684-4
5	25.0 [0.984]	796748-5	796684-5
6	30.0 [1.181]	796748-6	796684-6
7	35.0 [1.378]	796748-7	796684-7
8	40.0 [1.575]	796748-8	796684-8
9	45.0 [1.772]	796748-9	796684-9
10	50.0 [1.968]	1-796748-0	1-796684-0
11	55.0 [2.165]	1-796748-1	1-796684-1
12	60.0 [2.362]	1-796748-2	1-796684-2
13	65.0 [2.559]	1-796748-3	1-796684-3

No. of Positions	Dim. A	Part Numbers	
		Green	Blue
14	70.0 [2.756]	1-796748-4	1-796684-4
15	75.0 [2.953]	1-796748-5	1-796684-5
16	80.0 [3.150]	1-796748-6	1-796684-6
17	85.0 [3.346]	1-796748-7	1-796684-7
18	90.0 [3.543]	1-796748-8	1-796684-8
19	95.0 [3.740]	1-796748-9	1-796684-9
20	100.0 [3.937]	2-796748-0	2-796684-0
21	105.0 [4.134]	2-796748-1	2-796684-1
22	110.0 [4.331]	2-796748-2	2-796684-2
23	115.0 [4.528]	2-796748-3	2-796684-3
24	120.0 [4.724]	2-796748-4	2-796684-4
25	125.0 [4.921]	2-796748-5	2-796684-5

Note: BUCHANAN Terminal Block Series B02C4HxxT has been superseded/replaced with 796684-xx (blue).

Note: All part numbers are RoHS Compliant.

Board Mount, Top Wire Entry (Continued)

Board Mount w/Interlock, 5.0 mm Centerline, Top Wire Entry
Color – Green
UL Rating – 300 V, 24 A
12-30 AWG
20 A for field wiring applications

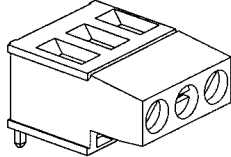

Suggested Screw Torque—
 7.0 in.-lbs.

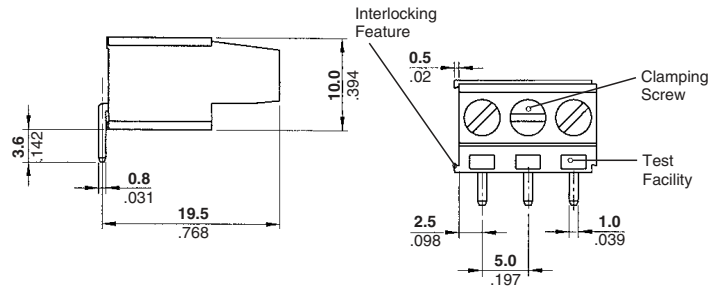
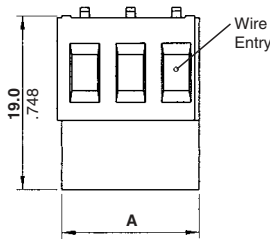

Recommended PC Board Layout

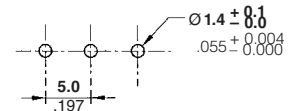

No. of Positions	Dim. A	Part Numbers
2	10.0 [.394]	282862-2
3	15.0 [.591]	282862-3
4	20.0 [.787]	282862-4
5	25.0 [.984]	282862-5
6	30.0 [1.181]	282862-6
7	35.0 [1.378]	282862-7
8	40.0 [1.575]	282862-8
9	45.0 [1.772]	282862-9
10	50.0 [1.968]	1-282862-0
11	55.0 [2.165]	1-282862-1
12	60.0 [2.362]	1-282862-2
13	65.0 [2.559]	1-282862-3

No. of Positions	Dim. A	Part Numbers
14	70.0 [2.756]	1-282862-4
15	75.0 [2.953]	1-282862-5
16	80.0 [3.150]	1-282862-6
17	85.0 [3.346]	1-282862-7
18	90.0 [3.543]	1-282862-8
19	95.0 [3.740]	1-282862-9
20	100.0 [3.937]	2-282862-0
21	105.0 [4.134]	2-282862-1
22	110.0 [4.331]	2-282862-2
23	115.0 [4.528]	2-282862-3
24	120.0 [4.724]	2-282862-4
25	125.0 [4.921]	2-282862-5

Board Mount w/Interlock, Low Profile, 5.08 mm Centerline, Top Wire Entry
UL Rating – 300 V, 13.5 A
16-30 AWG
10 A for field wiring applications

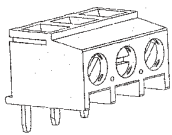

Suggested Screw Torque—
 6.0 in.-lbs.

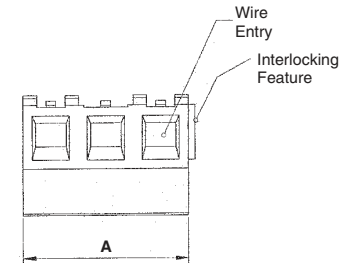
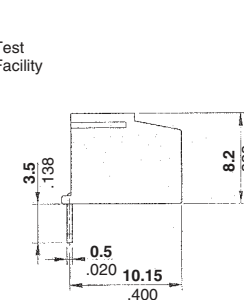
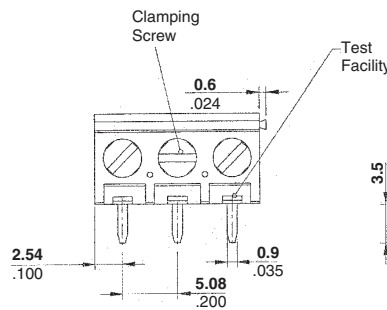

Recommended PC Board Layout

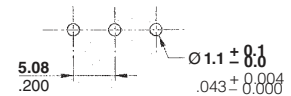

No. of Positions	Dim. A	Part Numbers	
		Green	Black*
2	10.16 [0.400]	284094-2	1776121-2
3	15.24 [0.600]	284094-3	1776121-3
4	20.32 [0.800]	284094-4	1776121-4
5	25.40 [1.000]	284094-5	1776121-5
6	30.48 [1.200]	284094-6	1776121-6
7	35.56 [1.400]	284094-7	1776121-7
8	40.64 [1.600]	284094-8	1776121-8
9	45.72 [1.800]	284094-9	—
10	50.80 [2.000]	1-284094-0	—
11	55.88 [2.200]	1-284094-1	—
12	60.96 [2.400]	1-284094-2	—
13	66.04 [2.600]	1-284094-3	—

No. of Positions	Dim. A	Part Numbers	
		Green	Black*
14	71.12 [2.800]	1-284094-4	—
15	76.20 [3.000]	1-284094-5	—
16	81.28 [3.200]	1-284094-6	—
17	86.36 [3.400]	1-284094-7	—
18	91.44 [3.600]	1-284094-8	—
19	96.52 [3.800]	1-284094-9	—
20	101.60 [4.000]	2-284094-0	—
21	106.68 [4.200]	2-284094-1	—
22	111.76 [4.400]	2-284094-2	—
23	116.84 [4.600]	2-284094-3	—
24	121.92 [4.800]	2-284094-4	—
25	127.00 [5.000]	2-284094-5	—

*Wave solder process capable to 265°C [509°F] for 10 seconds

Note: All part numbers are RoHS Compliant.

Board Mount, Top Wire Entry (Continued)

Board Mount w/Interlock, 5.08 mm Centerline, Top Wire Entry
UL Rating – 300 V, 17.5 A
12-30 AWG
15 A for field wiring applications

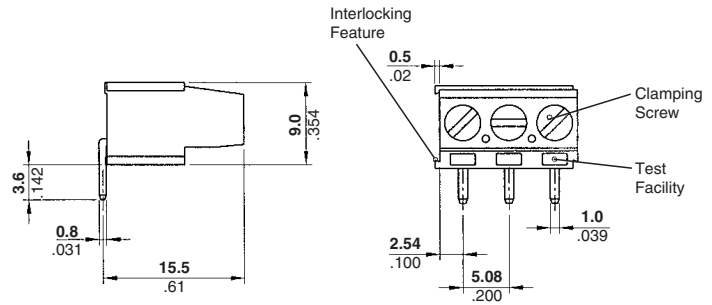
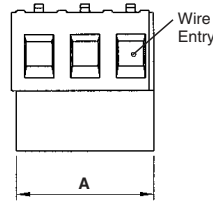
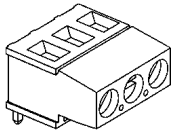

Recommended PC Board Layout

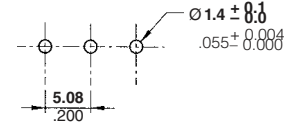

Suggested Screw Torque—
 7.0 in.-lbs.

No. of Positions	Dim. A	Part Numbers	
		Green	Black
2	10.16 [0.400]	282851-2	1546073-2
3	15.24 [0.600]	282851-3	1546073-3
4	20.32 [0.800]	282851-4	1546073-4
5	25.40 [1.000]	282851-5	1546073-5
6	30.48 [1.200]	282851-6	1546073-6
7	35.56 [1.400]	282851-7	1546073-7
8	40.64 [1.600]	282851-8	1546073-8
9	45.72 [1.800]	282851-9	1546073-9
10	50.80 [2.000]	1-282851-0	1-1546073-0
11	55.88 [2.200]	1-282851-1	1-1546073-1
12	60.96 [2.400]	1-282851-2	1-1546073-2
13	66.04 [2.600]	1-282851-3	1-1546073-3

No. of Positions	Dim. A	Part Numbers	
		Green	Black
14	71.12 [2.800]	1-282851-4	1-1546073-4
15	76.20 [3.000]	1-282851-5	1-1546073-5
16	81.28 [3.200]	1-282851-6	1-1546073-6
17	86.36 [3.400]	1-282851-7	1-1546073-7
18	91.44 [3.600]	1-282851-8	1-1546073-8
19	96.52 [3.800]	1-282851-9	1-1546073-9
20	101.60 [4.000]	2-282851-0	2-1546073-0
21	106.68 [4.200]	2-282851-1	2-1546073-1
22	111.76 [4.400]	2-282851-2	2-1546073-2
23	116.84 [4.600]	2-282851-3	2-1546073-3
24	121.92 [4.800]	2-282851-4	2-1546073-4
25	127.00 [5.000]	2-282851-5	2-1546073-5

Board Mount w/Interlock, 5.08 mm Centerline, Top Wire Entry Color – Green
UL Rating – 300 V, 24 A
12-30 AWG
20 A for field wiring applications

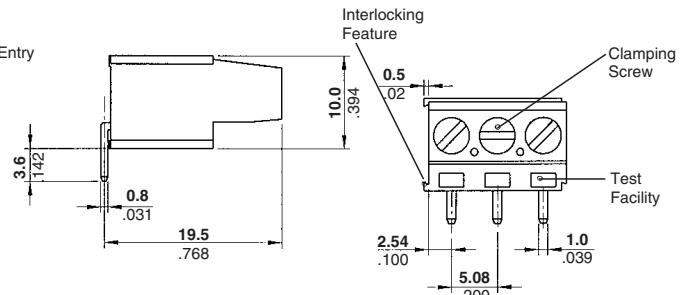
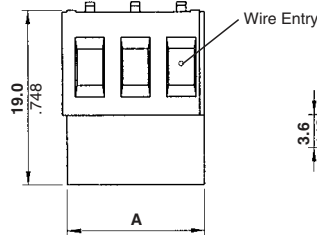
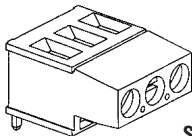

Recommended PC Board Layout

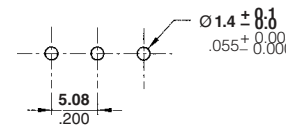

Suggested Screw Torque—
 7.0 in.-lbs.

No. of Positions	Dim. A	Part Numbers
2	10.16 [0.400]	282863-2
3	15.24 [0.600]	282863-3
4	20.32 [0.800]	282863-4
5	25.40 [1.000]	282863-5
6	30.48 [1.200]	282863-6
7	35.56 [1.400]	282863-7
8	40.64 [1.600]	282863-8
9	45.72 [1.800]	282863-9
10	50.80 [2.000]	1-282863-0
11	55.88 [2.200]	1-282863-1
12	60.96 [2.400]	1-282863-2
13	66.04 [2.600]	1-282863-3

No. of Positions	Dim. A	Part Numbers
14	71.12 [2.800]	1-282863-4
15	76.20 [3.000]	1-282863-5
16	81.28 [3.200]	1-282863-6
17	86.36 [3.400]	1-282863-7
18	91.44 [3.600]	1-282863-8
19	96.52 [3.800]	1-282863-9
20	101.60 [4.000]	2-282863-0
21	106.68 [4.200]	2-282863-1
22	111.76 [4.400]	2-282863-2
23	116.84 [4.600]	2-282863-3
24	121.92 [4.800]	2-282863-4
25	127.00 [5.000]	2-282863-5

Note: All part numbers are RoHS Compliant.

Board Mount, Top Wire Entry (Continued)

Top Wire Entry
7.5 mm Centerline,
Color – Green
UL Rating – 300 V, 17.5 A
12-30 AWG
15 A for field wiring applications

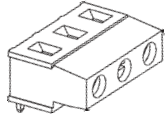

Suggested Screw Torque—
7.0 in.-lbs.

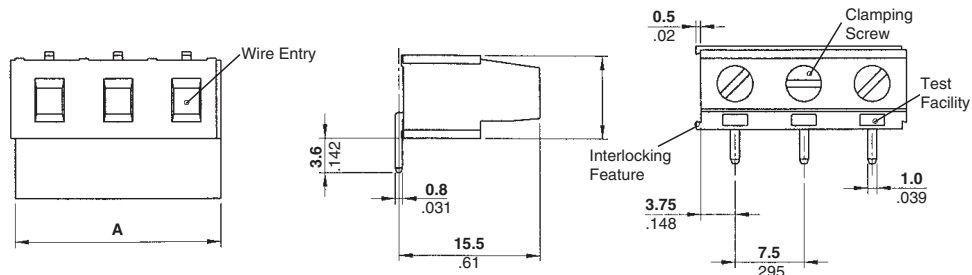

No. of Positions	Dim. A	Part Numbers
2	15.0 [0.591]	282854-2
3	22.5 [0.886]	282854-3
4	30.0 [1.181]	282854-4

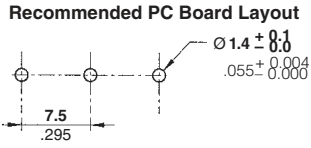

Top Wire Entry
7.62 mm Centerline,
Color – Green
UL Rating – 300 V, 17.5 A
12-30 AWG
15 A for field wiring applications

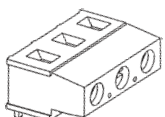

Suggested Screw Torque—
7.0 in.-lbs.

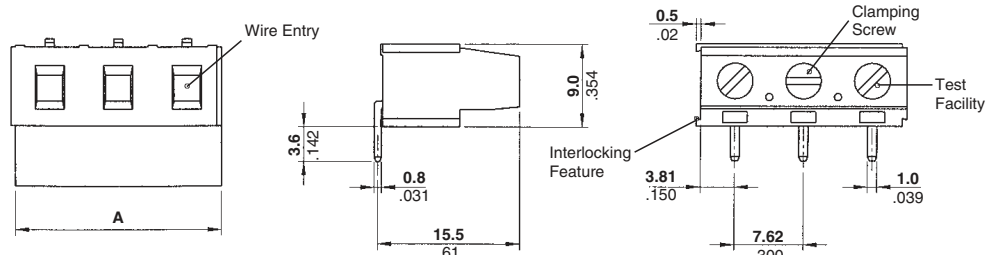

No. of Positions	Dim. A	Part Numbers
2	15.24 [.600]	282855-2
3	22.86 [.900]	282855-3

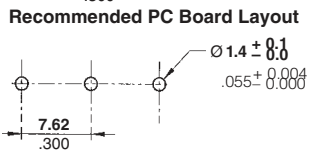

Top Wire Entry
7.62 mm Centerline,
Color – Green
UL Rating – 300 V, 24 A
12-30 AWG
20 A for field wiring applications

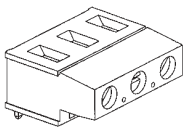

Suggested Screw Torque—
7.0 in.-lbs.

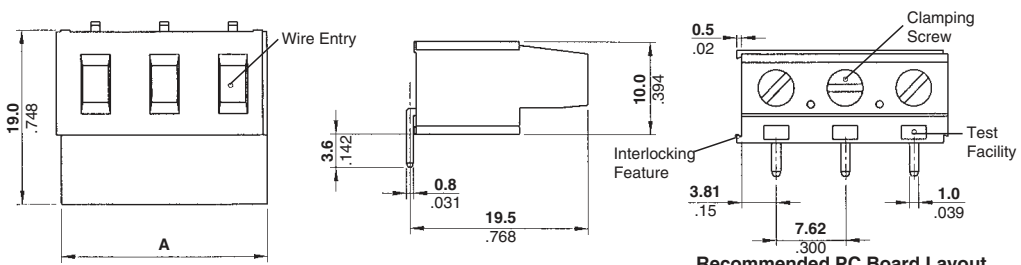

No. of Positions	Dim. A	Part Numbers
2	15.24 [.600]	282867-2
3	22.86 [.900]	282867-3

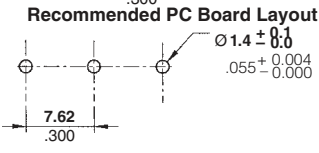

Note: All part numbers are RoHS Compliant.

Board Mount, Top Wire Entry (Continued)

Board Mount, Low Profile
10.0 mm Centerline,
Top Wire Entry,
Color – Black
UL Rating – 600 V, 13.5 A
16-30 AWG
10 A for field wiring applications

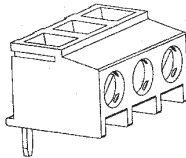

Suggested Screw Torque—
 6.0 in.-lbs.

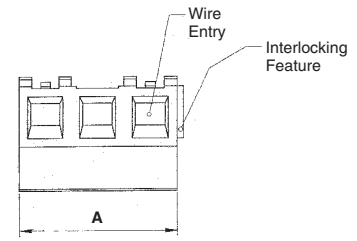
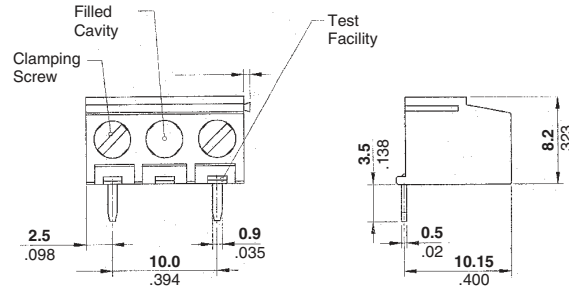

Recommended PC Board Layout

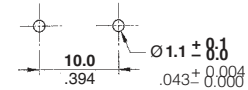

No. of Positions	Dim. A	Part Numbers
2	15.0 [.591]	1776124-2
3	20.0 [.787]	1776124-3
4	25.0 [.984]	1776124-4

Wave solder process capable to 265°C [509°F] for 10 seconds

Board Mount
10.0 mm Centerline,
Top Wire Entry
Color – Green
UL Rating – 600 V, 17.5 A
12-30 AWG
15 A for field entry applications

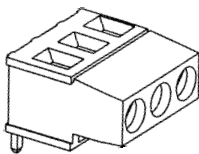

Suggested Screw Torque—
 7.0 in.-lbs.

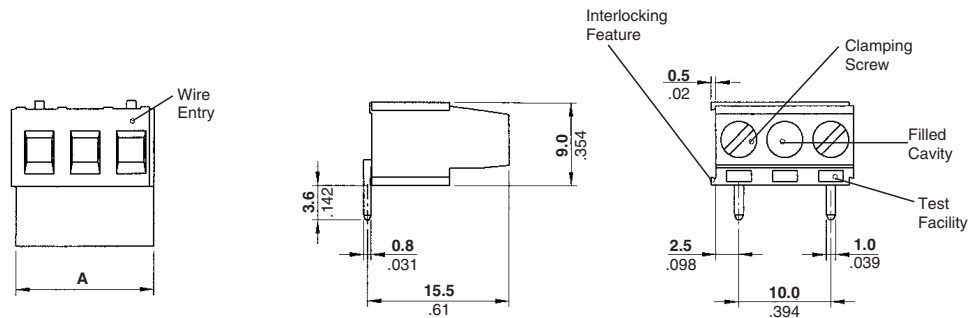

Recommended PC Board Layout

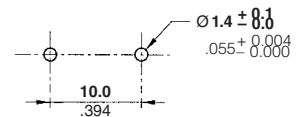

No. of Positions	Dim. A	Part Numbers
2	15.0 [.591]	282852-2
3	20.0 [.787]	282852-3
4	25.0 [.984]	282852-4
5	30.0 [1.181]	282852-5
6	35.0 [1.378]	282852-6
7	40.0 [1.575]	282852-7
8	45.0 [1.772]	282852-8
9	50.0 [1.968]	282852-9
10	55.0 [2.165]	1-282852-0
11	60.0 [2.362]	1-282852-1
12	65.0 [2.559]	1-282852-2
13	70.0 [2.775]	1-282852-3

Note: All part numbers are RoHS Compliant.

Board Mount, Top Wire Entry (Continued)

Board Mount, Low Profile, 10.16 mm Centerline, Top Wire Entry
Color – Black

UL Rating – 600 V, 13.5 A
16-30 AWG
10 A for field wiring applications

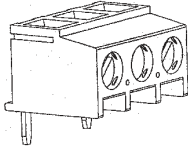

Suggested Screw Torque—
6.0 in.-lbs.

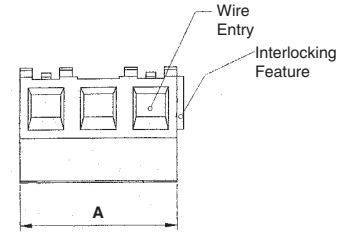
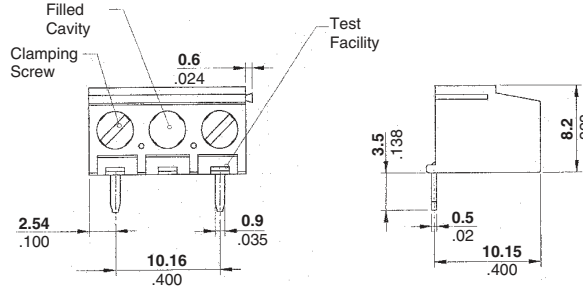

No. of Positions	Dim. A	Part Numbers
2	15.24 [0.600]	1776125-2
3	20.32 [0.800]	1776125-3
4	25.40 [1.000]	1776125-4

Wave solder process capable to 265°C [509°F] for 10 seconds

Recommended PC Board Layout

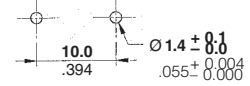

Board Mount, 10.16 mm Centerline, Top Wire Entry
Color – Green

UL Rating – 600 V, 17.5 A
12-30 AWG
15 A for field wiring applications

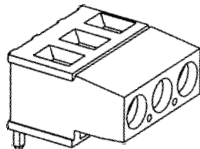

Suggested Screw Torque—
7.0 in.-lbs.

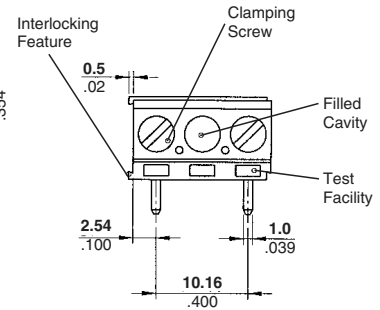
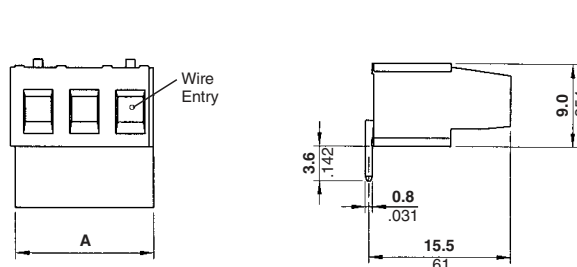

No. of Positions	Dim. A	Part Numbers
2	15.24 [0.600]	282853-2
3	20.32 [0.800]	282853-3
4	25.40 [1.000]	282853-4
5	30.48 [1.200]	282853-5
6	35.56 [1.400]	282853-6
7	40.64 [1.600]	282853-7
8	45.72 [1.800]	282853-8
9	50.80 [2.000]	282853-9
10	55.88 [2.200]	1-282853-0
11	60.96 [2.400]	1-282853-1
12	66.04 [2.600]	1-282853-2
13	71.12 [2.800]	1-282853-3

Recommended PC Board Layout

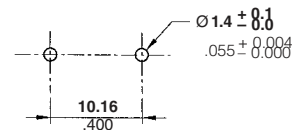

Note: All part numbers are RoHS Compliant.

Board Mount, 35° Angled Wire Entry

**Board Mount w/Interlock,
5.0 mm Centerline,
35° Angled Wire Entry**
UL Rating – 300 V, 17.5 A
12-30 AWG
15 A for field wiring applications

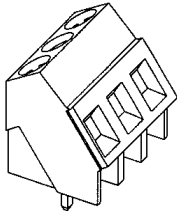

Suggested Screw Torque—
7.0 in.-lbs.

Notes:

1. BUCHANAN Terminal Block Series B04C4VXXT has been superceded/replaced with part number 796688-xx (blue color) and 796689-xx (black color).
2. RDI Terminal Block Series 5LEA-XX has been superceded/replaced with part number 796690-xx (green color).
3. RDI Terminal Block Series 5LEA-XX-1 has been superceded/replaced with part number 796689-xx (black color).

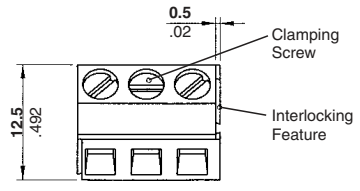
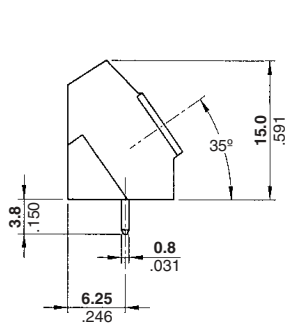
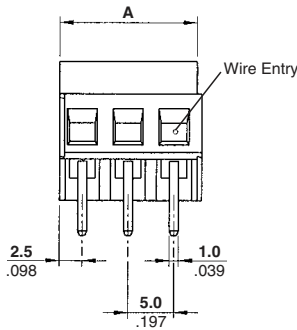

Recommended PC Board Layout

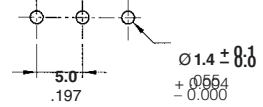

No. of Positions	Dim. A	Part Numbers			
		Gray	Blue	Black	Green
2	10.0 [0.394]	1546219-2	796688-2	796689-2	796690-2
3	15.0 [0.591]	1546219-3	796688-3	796689-3	796690-3
4	20.0 [0.787]	1546219-4	796688-4	796689-4	796690-4
5	25.0 [0.984]	1546219-5	796688-5	796689-5	796690-5
6	30.0 [1.181]	1546219-6	796688-6	796689-6	796690-6
7	35.0 [1.378]	1546219-7	796688-7	796689-7	796690-7
8	40.0 [1.575]	1546219-8	796688-8	796689-8	796690-8
9	45.0 [1.772]	1546219-9	796688-9	796689-9	796690-9
10	50.0 [1.968]	1-1546219-0	1-796688-0	1-796689-0	1-796690-0
11	55.0 [2.165]	1-1546219-1	1-796688-1	1-796689-1	1-796690-1
12	60.0 [2.362]	1-1546219-2	1-796688-2	1-796689-2	1-796690-2

**Board Mount w/Interlock,
5.08 mm Centerline,
35° Angled Wire Entry**
UL Rating – 300 V, 17.5 A
12-30 AWG
15 A for field wiring applications

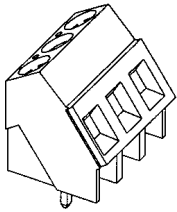

Suggested Screw Torque—
7.0 in.-lbs.

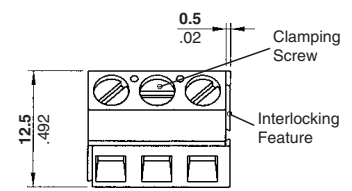
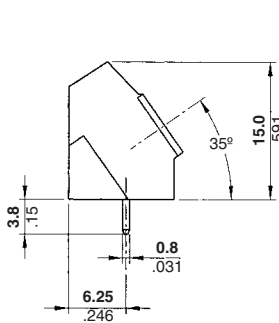
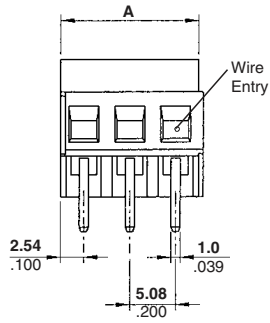

Recommended PC Board Layout

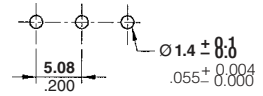

No. of Positions	Dim. A	Part Numbers		
		Gray	Green	Black
2	10.16 [0.400]	1546220-2	282847-2	1546074-2
3	15.24 [0.600]	1546220-3	282847-3	1546074-3
4	20.32 [0.800]	1546220-4	282847-4	1546074-4
5	25.40 [1.000]	1546220-5	282847-5	1546074-5
6	30.48 [1.200]	1546220-6	282847-6	1546074-6
7	35.56 [1.400]	1546220-7	282847-7	1546074-7
8	40.64 [1.600]	1546220-8	282847-8	1546074-8
9	45.72 [1.800]	1546220-9	282847-9	1546074-9
10	50.80 [2.000]	1-1546220-0	1-282847-0	1-1546074-0
11	55.88 [2.200]	1-1546220-1	1-282847-1	1-1546074-1
12	60.96 [2.400]	1-1546220-2	1-282847-2	1-1546074-2

Note: RDI Terminal Block Series 2EEA-xx has been superceded/replaced with 282847-xx series.

Note: All part numbers are RoHS Compliant.

Board Mount, 35° Angled Wire Entry (Continued)

**Board Mount,
10.0 mm Centerline,
35° Angled Wire Entry
Color – Green**
**UL Rating – 600 V, 17.5 A
12-30 AWG
15 A for field wiring applications**

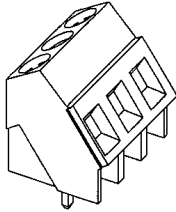

**Suggested Screw Torque—
7.0 in.-lbs.**

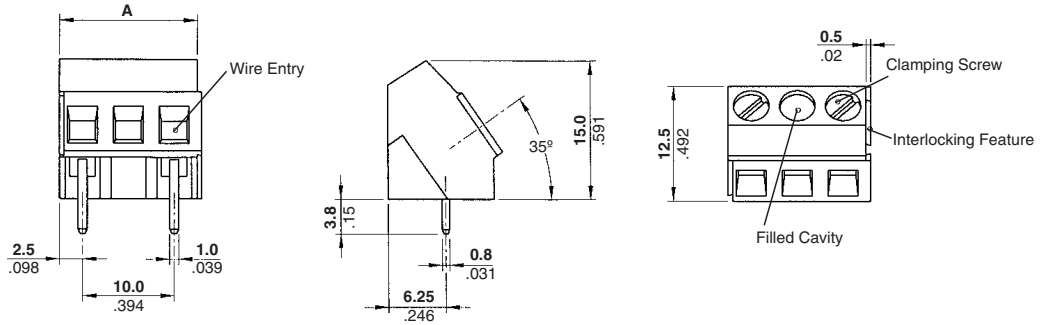

No. of Positions	Dim. A	Part Numbers
2	15.0 [0.591]	282848-2
3	25.0 [0.984]	282848-3
4	35.0 [1.378]	282848-4
5	45.0 [1.772]	282848-5
6	55.0 [2.165]	282848-6

Recommended PC Board Layout

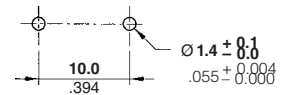

**Board Mount,
10.16 mm Centerline,
35° Angled Wire Entry
Color – Green**
**UL Rating – 600 V, 17.5 A
12-30 AWG
15 A for field wiring applications**

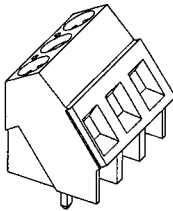

**Suggested Screw Torque—
7.0 in.-lbs.**

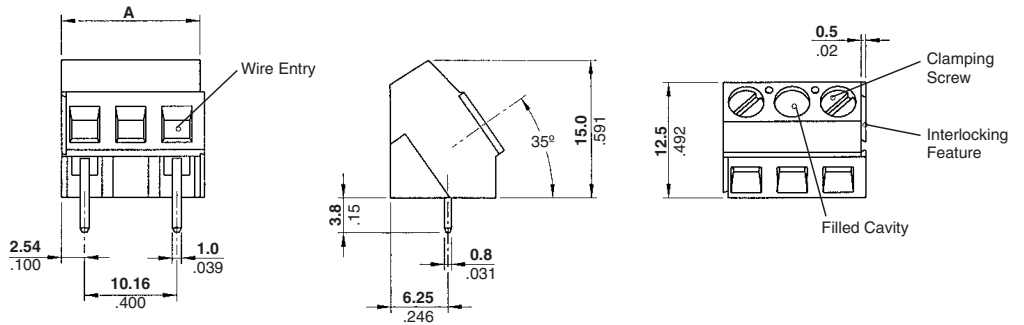

No. of Positions	Dim. A	Part Numbers
2	15.24 [0.600]	282849-2
3	25.40 [1.000]	282849-3
4	35.56 [1.400]	282849-4
5	45.72 [1.800]	282849-5
6	55.88 [2.200]	282849-6

Recommended PC Board Layout

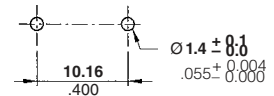

Note: All part numbers are RoHS Compliant.

Board Mount, Bottom Wire Entry

**Board Mount w/Interlock,
5.0 mm Centerline,
270° Bottom Wire Entry
Color – Green**

**UL Rating – 300 V, 17.5 A
12-30 AWG
15 A for field wiring applications**

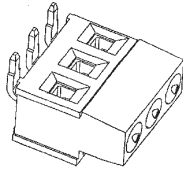

Suggested Screw Torque—
7.0 in.-lbs.

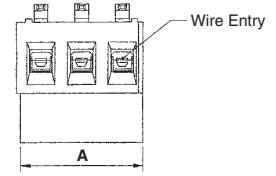
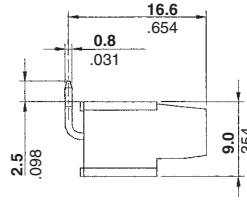
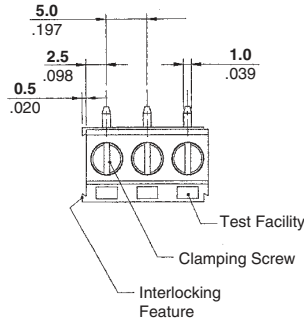

Recommended PC Board Layout

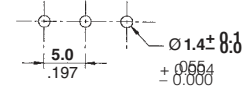

No. of Positions	Dim. A	Part Numbers
2	10.0 [0.394]	284410-2
3	15.0 [0.591]	284410-3
4	20.0 [0.787]	284410-4
5	25.0 [0.984]	284410-5
6	30.0 [1.181]	284410-6
7	35.0 [1.378]	284410-7
8	40.0 [1.575]	284410-8
9	45.0 [1.772]	284410-9
10	50.0 [1.968]	1-284410-0
11	55.0 [2.165]	1-284410-1
12	60.0 [2.362]	1-284410-2
13	65.0 [2.559]	1-284410-3
14	70.0 [2.756]	1-284410-4
15	75.0 [2.953]	1-284410-5
16	80.0 [3.150]	1-284410-6
17	85.0 [3.346]	1-284410-7
18	90.0 [3.543]	1-284410-8
19	95.0 [3.740]	1-284410-9
20	100.0 [3.937]	2-284410-0
21	105.0 [4.134]	2-284410-1
22	110.0 [4.331]	2-284410-2
23	115.0 [4.528]	2-284410-3
24	120.0 [4.724]	2-284410-4
25	125.0 [4.921]	2-284410-5

High Current PCB Mount, Side Wire Entry

Product Facts

- Available in (2) centerline spacings: 6.35 mm and 9.52 mm pitch
- (2) position sizes available: 2 and 3 position
- Wire range: 10-24 AWG
- Available in (3) wire entry configurations: side wire, top wire and 35° angle

- Cage clamp style termination
- Product is modular; designed with a dovetail feature to allow building larger position sizes to increase the number of available wire positions
- Green color; other colors available upon request



**Board Mount w/Interlock,
6.35 mm Centerline,
Side Wire Entry,
Color – Green**

**UL Rating—300 V, 30 A
10-24 AWG**

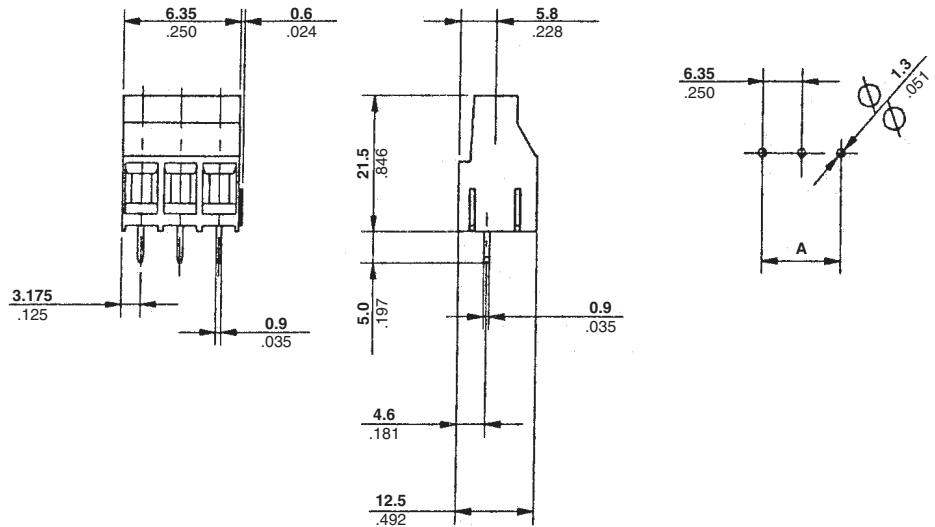

**Suggested Screw Torque—
7.0 in.-lbs.**

No. of Positions	Dim. A	Part Numbers
2	6.35 0.250	796740-2
3	12.70 0.500	796740-3

**Board Mount w/Interlock,
9.52 mm Centerline,
Side Wire Entry,
Color – Green**

**UL Rating—600 V, 30 A
10-24 AWG**

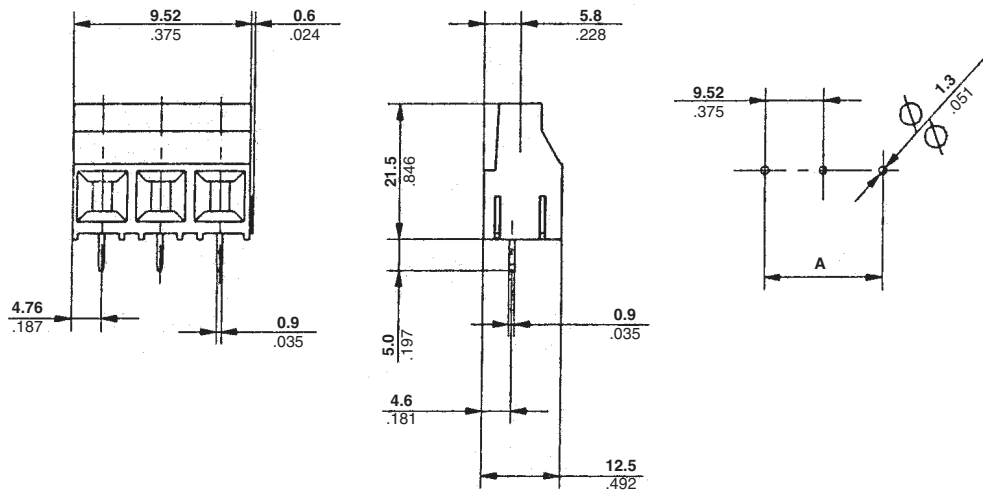

**Suggested Screw Torque—
7.0 in.-lbs.**

No. of Positions	Dim. A	Part Numbers
2	9.52 0.375	796739-2
3	19.04 0.704	796739-3

Note: All part numbers are RoHS Compliant.

High Current PCB Mount, 35° Angled Wire Entry

**Board Mount w/Interlock,
9.52 mm Centerline,
35° Wire Entry
Color – Green**

**UL Rating – 600 V, 30 A
10-24 AWG**

**Suggested Screw Torque—
7.0 in.-lbs.**

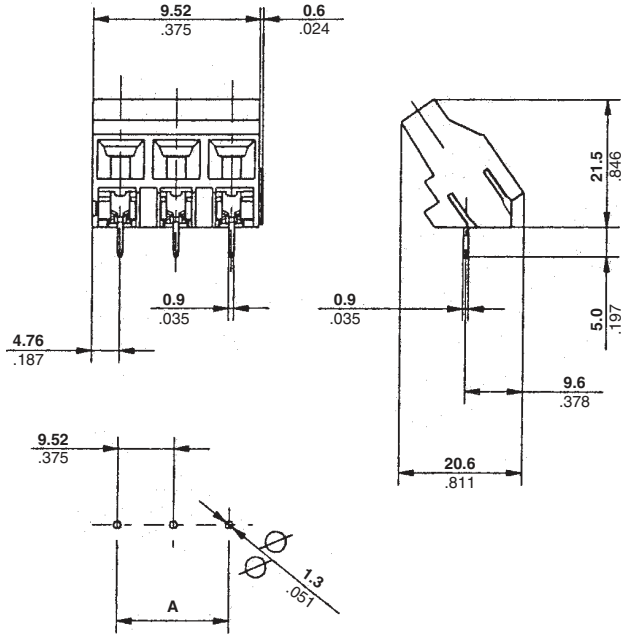

No. of Positions	Dim. A	Part Numbers
2	9.52 0.375	796741-2
3	19.04 0.704	796741-3

**Board Mount w/Interlock,
10.16 mm Centerline,
Side Wire Entry
Color – Green or Black**

**UL Rating – 300 V, 52 A
6-8 AWG**

**Suggested Screw Torque—
10.16 in.-lbs.**

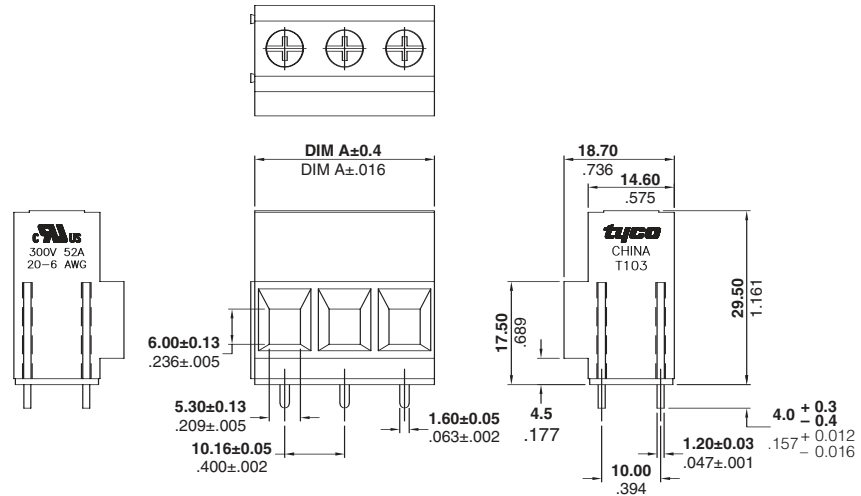

No. of Positions	Dim. A	Part Numbers	
		Green	Black
2	20.32 [.800]	1776886-2	1-1776886-2
3	30.48 [1.200]	1776886-3	1-1776886-3

Note: All part numbers are RoHS Compliant.

Board Mount Multi-Level Stacking

Board Mount w/Interlock, Multi-Level Stacking 16-30 AWG

Product Facts

- One-piece board mount terminal blocks
- Interchangeable with existing products of other terminal block suppliers
- PC board footprint fully compatible with existing Industry Standards: pc board thickness 1.6–2.4 mm
- Modular design with interlocking fixture to assemble higher number of ways applies to 5.0 and 5.08 mm centerlines
- Rising screw clamp design
- Funnel entry housing for easier wire insertion
- Test probe access
- Terminal blocks supplied with open captive screws

Tyco Electronics is expanding the range of board mount terminal blocks with its family of multi-level Terminal Block stacking connectors; three different heights are available to combine one-piece blocks, according to the user's need for better space utilization and easier wire accessibility.

5.0, 5.08, 10.0 and 10.16 mm centerline blocks suitable for 1.5 mm² max. solid wire and 1.0 mm² max. stranded wire are described in the following pages.

Mechanical/Environmental Performance

Operating Temperature—
-40°C up to +105°C

Climate Category—
40/110/21 per IEC 68-1

Level	Height	Level Combinations
1st Level	10.0 mm	1st and 2nd level; 2nd and 3rd level; three levels, 2nd level; 3rd level
2nd Level	19.0 mm	
3rd Level	28.0 mm	

Board Mount w/Interlock, Multi-Level Stacking 12-30 AWG

5.0, 5.08, 10.0 and 10.16 mm centerline blocks suitable for 4.0 mm² max. solid wire and 2.5 mm² max. stranded wire are described in the following pages.

Mechanical/Environmental Performance

Operating Temperature—
-40°C up to +105°C

Climate Category—
40/110/21 per IEC 68-1

Level	Height
1st Level	18.6 mm
2nd Level	31.5 mm
3rd Level	45.0 mm

Centerline	No. of Pos.	Level Combinations
5.00 mm	2–3	1st and 2nd level; 2nd and 3rd level; three levels, 2nd level; 3rd level
5.08 mm	2–3	1st and 2nd level; 2nd and 3rd level; three levels, 2nd level; 3rd level
10.00 mm	2	1st and 2nd level; 2nd and 3rd level; three levels, 2nd level; 3rd level
10.16 mm	2	1st and 2nd level; 2nd and 3rd level; three levels, 2nd level; 3rd level

Note: All part numbers are RoHS Compliant.

Board Mount, 1st and 2nd Level Stacking Connectors

Board Mount w/Interlock, 5.0 mm Centerline, 1st and 2nd Level, Stacking Color – Green

UL Rating – 300 V, 13.5 A 16-30 AWG 10 A for field wiring applications

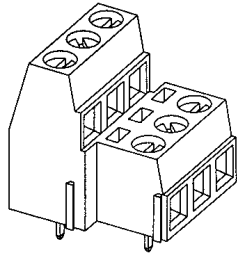

Suggested Screw Torque—
6.0 in.-lb.

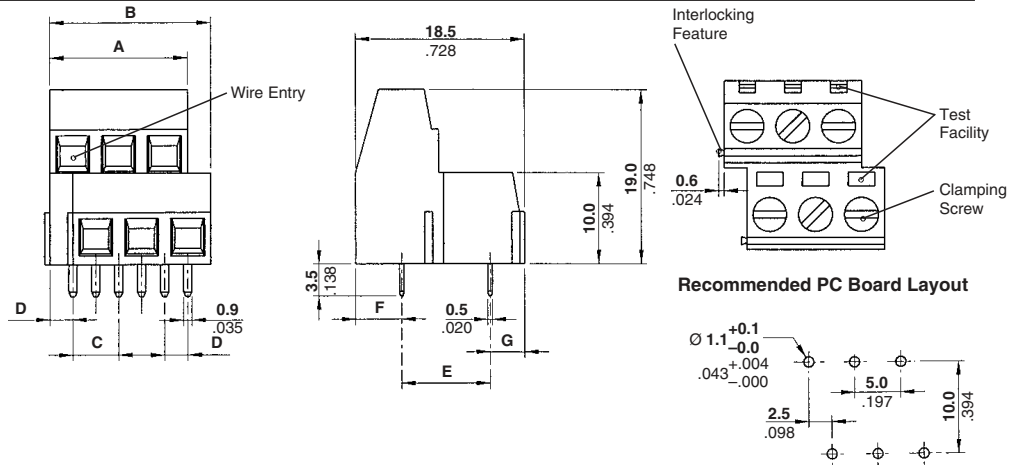

No. of Positions	Dimensions							Part Numbers
	A	B	C	D	E	F	G	
2	10.0 .394	12.5 .492	5.0 .197	2.5 .098	10.0 .394	4.4 .173	4.1 .161	282868-2
3	15.0 .591	17.5 .689	5.0 .197	2.5 .098	10.0 .394	4.4 .173	4.1 .161	282868-3

Board Mount w/Interlock, 5.0 mm Centerline, 1st and 2nd Level, Stacking

UL Rating – 300 V, 17.5 A 12-30 AWG 15 A for field wiring applications

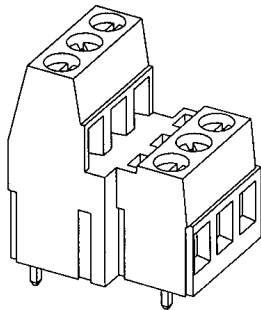

Suggested Screw Torque—
7.0 in.-lb.

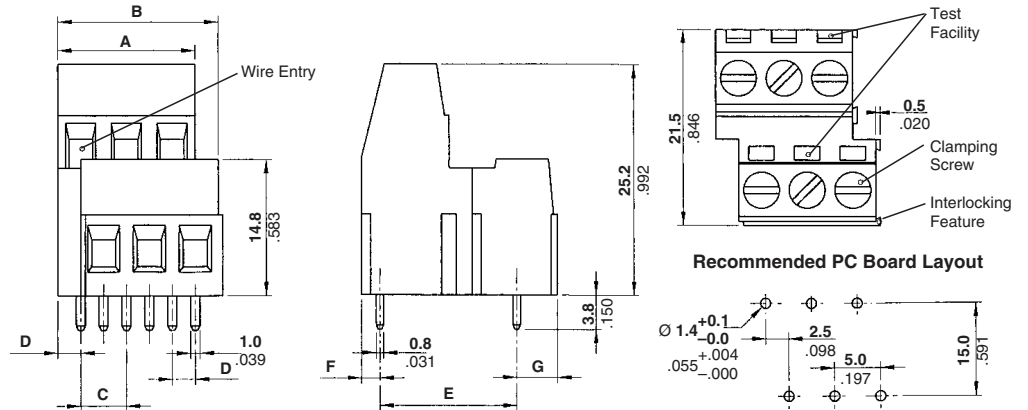

No. of Positions	Dimensions							Part Numbers	
	A	B	C	D	E	F	G	Green	Blue
2	10.0 .394	12.5 .492	5.0 .197	2.5 .098	15.0 .591	2.0 .079	4.5 .177	282888-2	796691-2
3	15.0 .591	17.5 .689	5.0 .197	2.5 .098	15.0 .591	2.0 .079	4.5 .177	282888-3	796691-3
4	20.0 .787	22.5 .886	5.0 .197	2.5 .098	15.0 .591	2.0 .079	4.5 .177	—	796691-4
5	25.0 .984	27.5 1.083	5.0 .197	2.5 .098	15.0 .591	2.0 .079	4.5 .177	—	796691-5
6	30.0 1.181	32.5 1.28	5.0 .197	2.5 .098	15.0 .591	2.0 .079	4.5 .177	—	796691-6
7	35.0 1.378	37.5 1.476	5.0 .197	2.5 .098	15.0 .591	2.0 .079	4.5 .177	—	796691-7
8	40.0 1.575	42.5 1.673	5.0 .197	2.5 .098	15.0 .591	2.0 .079	4.5 .177	—	796691-8
9	45.0 1.772	47.5 1.87	5.0 .197	2.5 .098	15.0 .591	2.0 .079	4.5 .177	—	796691-9
10	50.0 1.968	52.5 2.067	5.0 .197	2.5 .098	15.0 .591	2.0 .079	4.5 .177	—	1-796691-0
11	55.0 2.165	57.5 2.264	5.0 .197	2.5 .098	15.0 .591	2.0 .079	4.5 .177	—	1-796691-1
12	60.0 2.362	62.5 2.461	5.0 .197	2.5 .098	15.0 .591	2.0 .079	4.5 .177	—	1-796691-2

Note: BUCHANAN Terminal Block Series B07C4VxxT has been superceded/replaced with 796691-xx (blue). RDI Terminal Block Series 5LEEV-xx has been superceded/replaced with 796691-xx.

Note: All part numbers are RoHS Compliant.

Board Mount, 1st and 2nd Level Stacking Connectors (Continued)

Board Mount w/Interlock, 5.08 mm Centerline, 1st and 2nd Level, Stacking Color – Green

**UL Rating – 300 V, 13.5 A
16-30 AWG
10 A for field wiring applications**

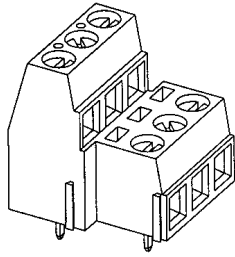

Suggested Screw Torque—
6.0 in.-lb.

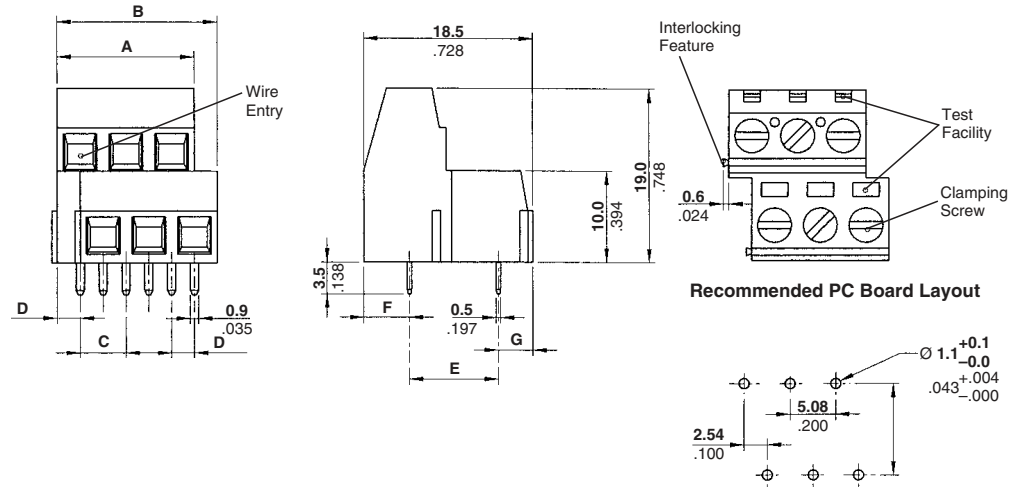

No. of Positions	Dimensions							Part Numbers
	A	B	C	D	E	F	G	
2	10.16 .400	12.70 .500	5.08 .200	2.54 .100	10.16 .400	4.24 .167	4.1 .161	282869-2
3	15.24 .600	17.78 .700	5.08 .200	2.54 .100	10.16 .400	4.24 .167	4.1 .161	282869-3

Board Mount w/Interlock, 5.08 mm Centerline, 1st and 2nd Level, Stacking

**UL Rating – 300 V, 17.5 A
12-30 AWG
15 A for field wiring applications**

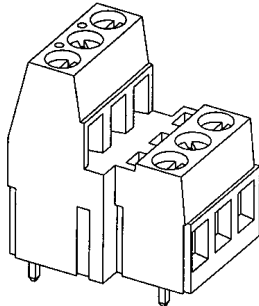

Suggested Screw Torque—
7.0 in.-lb.

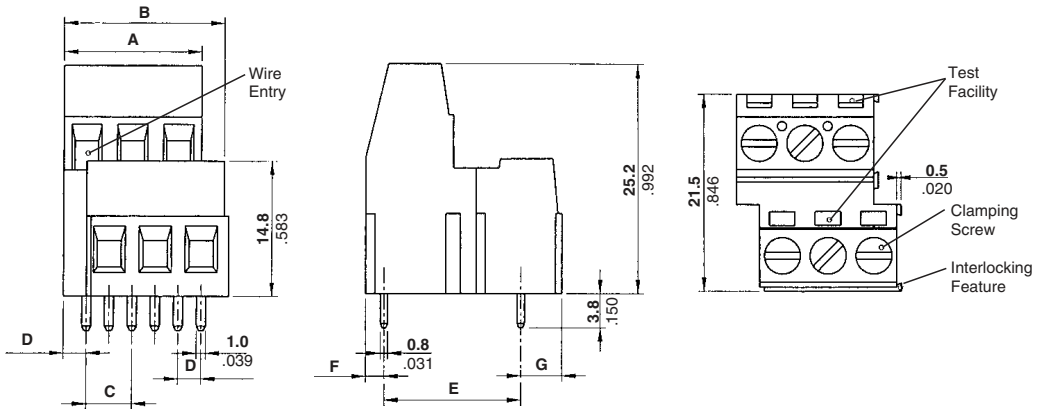

No. of Positions	Dimensions							Part Numbers		
	A	B	C	D	E	F	G	Gray	Green	Black
2	10.16 .400	12.70 .500	5.08 .200	2.54 .100	15.24 .600	1.76 .069	4.5 .177	1546222-2	796692-2	796984-2
3	15.24 .600	17.78 .700	5.08 .200	2.54 .100	15.24 .600	1.76 .069	4.5 .177	1546222-3	796692-3	796984-3
4	20.32 0.80	22.86 0.90	5.08 .200	2.54 .100	15.24 .600	1.76 .069	4.5 .177	—	796692-4	796984-4
5	25.40 1.00	27.94 1.10	5.08 .200	2.54 .100	15.24 .600	1.76 .069	4.5 .177	—	796692-5	796984-5
6	30.48 1.20	33.02 1.30	5.08 .200	2.54 .100	15.24 .600	1.76 .069	4.5 .177	—	796692-6	796984-6
7	35.56 1.40	38.10 1.50	5.08 .200	2.54 .100	15.24 .600	1.76 .069	4.5 .177	—	796692-7	796984-7
8	40.64 1.60	43.18 1.70	5.08 .200	2.54 .100	15.24 .600	1.76 .069	4.5 .177	—	796692-8	796984-8
9	45.72 1.80	48.26 1.90	5.08 .200	2.54 .100	15.24 .600	1.76 .069	4.5 .177	—	796692-9	796984-9
10	50.80 2.00	53.34 2.10	5.08 .200	2.54 .100	15.24 .600	1.76 .069	4.5 .177	—	1-796692-0	1-796984-0
11	55.88 2.20	58.42 2.30	5.08 .200	2.54 .100	15.24 .600	1.76 .069	4.5 .177	—	1-796692-1	1-796984-1
12	60.96 2.40	63.50 2.50	5.08 .200	2.54 .100	15.24 .600	1.76 .069	4.5 .177	—	1-796692-2	1-796984-2

Note: RDI Terminal Block Series 2LEEV-xx/2 has been superceded/replaced with 796692-xx (green).

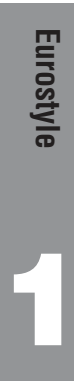
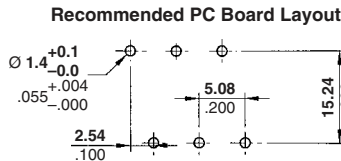

Note: All part numbers are RoHS Compliant.

Board Mount, 1st and 2nd Level Stacking Connectors (Continued)

Board Mount w/Interlock, 5.08 mm Centerline, 1st and 2nd Level, Stacking Color – Green

**UL Rating – 300 V, 24 A
12-30 AWG
20 A for field wiring applications**

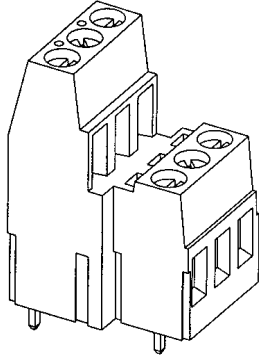

Suggested Screw Torque—
7.0 in.-lb.

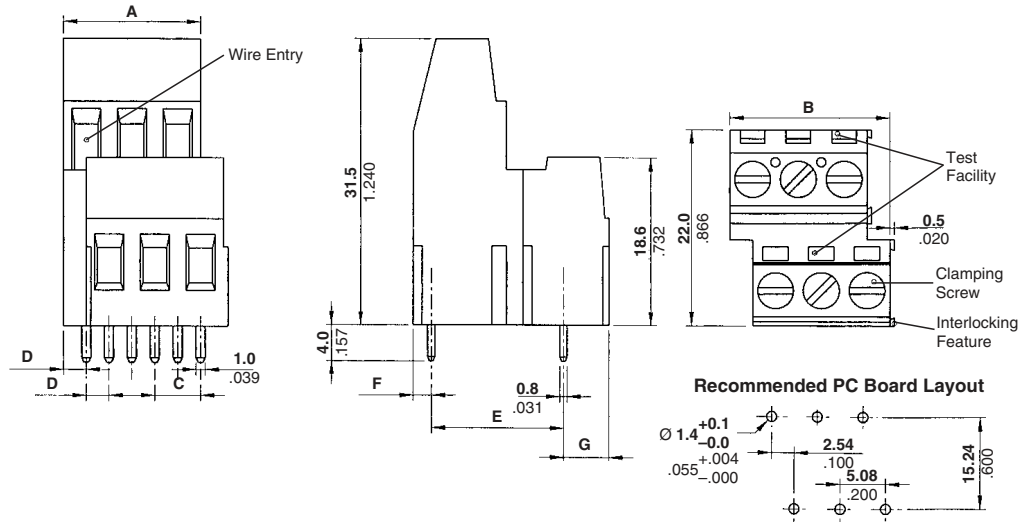

No. of Positions	Dimensions							Part Numbers
	A	B	C	D	E	F	G	
2	10.16 .400	12.70 .500	5.08 .200	2.54 .100	15.24 .600	1.76 .069	5.0 .197	282909-2
3	15.24 .600	17.78 .700	5.08 .200	2.54 .100	15.24 .600	1.76 .069	5.0 .197	282909-3

Board Mount, 2nd and 3rd Level Stacking Connectors

Board Mount w/Interlock, 5.08 mm Centerline, 2nd and 3rd Level, Stacking Color – Green

**UL Rating – 300 V, 13.5 A
16-30 AWG
10 A for field wiring applications**

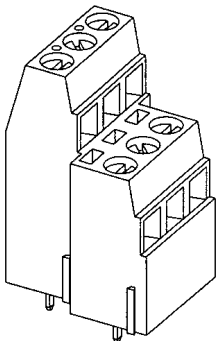

Suggested Screw Torque—
6.0 in.-lb.

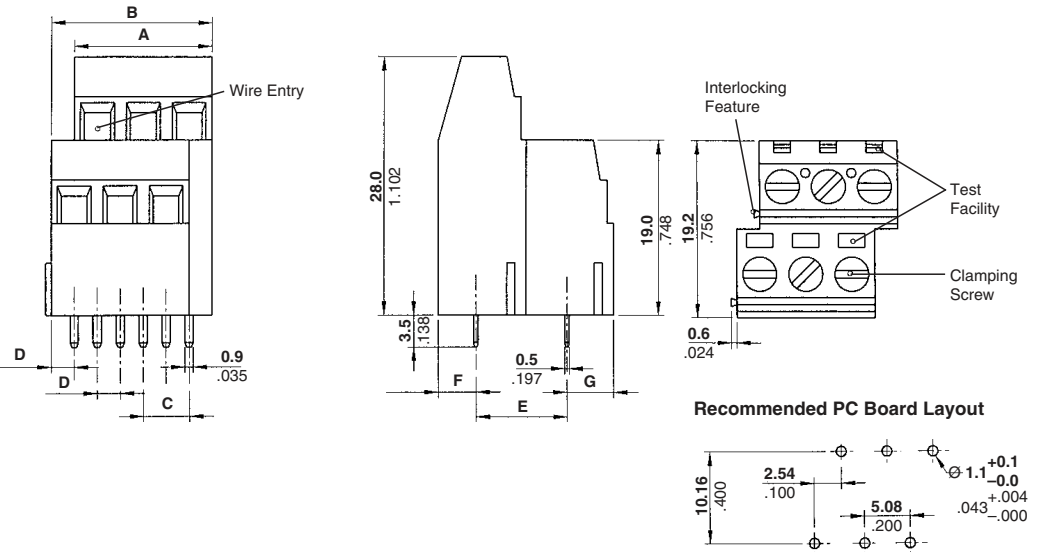

No. of Positions	Dimensions							Part Numbers
	A	B	C	D	E	F	G	
2	10.16 .400	12.70 .500	5.08 .200	2.54 .100	10.16 .400	3.78 .149	5.26 .207	282873-2
3	15.24 .600	17.78 .700	5.08 .200	2.54 .100	10.16 .400	3.78 .149	5.26 .207	282873-3

Note: All part numbers are RoHS Compliant.

Board Mount, 2nd and 3rd Level Stacking Connectors (Continued)

Board Mount w/Interlock, 5.08 mm Centerline, 2nd and 3rd Level, Stacking Color – Green

**UL Rating – 300 V, 24 A
12-30 AWG
20 A for field wiring applications**

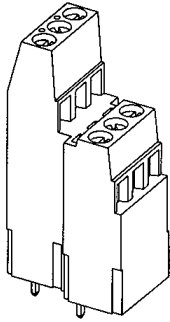

Suggested Screw Torque—
7.0 in.-lb.

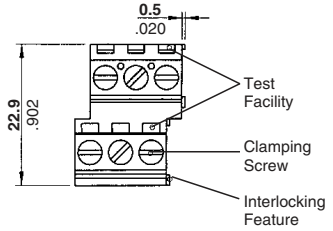
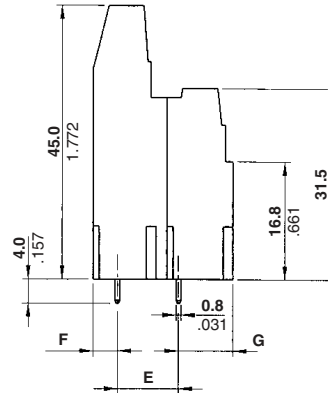
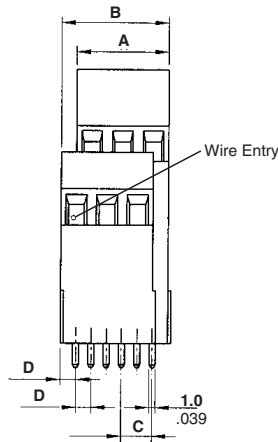

Recommended PC Board Layout

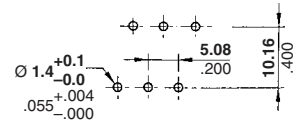

No. of Positions	Dimensions							Part Numbers
	A	B	C	D	E	F	G	
2	10.16 .400	12.70 .500	5.08 .200	2.54 .100	10.16 .400	3.6 .142	9.14 .360	282913-2
3	15.24 .600	17.78 .700	5.08 .200	2.54 .100	10.16 .400	3.6 .142	9.14 .360	282913-3

Board Mount, Three-Levels Stacking Connectors

Board Mount w/Interlock, 5.0 mm Centerline, Three Levels, Stacking Color – Green

**UL Rating – 300 V, 13.5 A
16-30 AWG
10 A for field wiring applications**

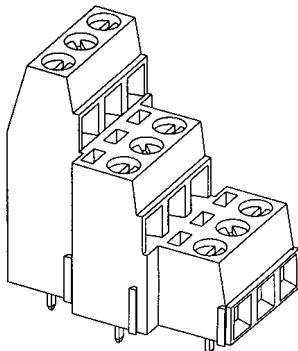

Suggested Screw Torque—
6.0 in.-lb.

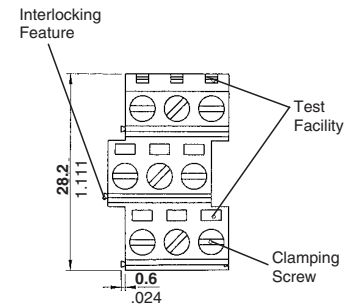
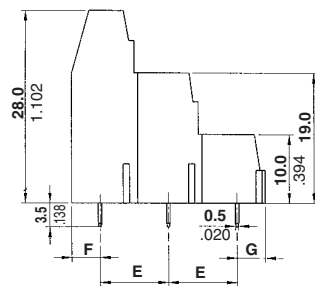
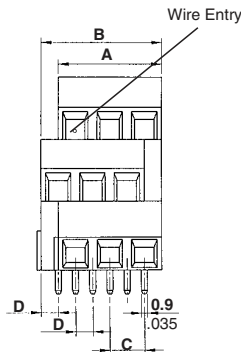

Recommended PC Board Layout

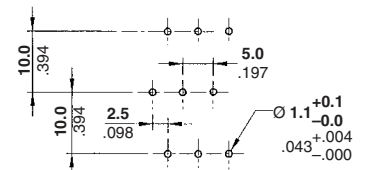

No. of Positions	Dimensions							Part Numbers
	A	B	C	D	E	F	G	
2	10.0 .394	12.5 .492	5.0 .197	2.5 .098	10.0 .394	4.1 .161	4.1 .161	282876-2
3	15.0 .591	17.5 .689	5.0 .197	2.5 .098	10.0 .394	4.1 .161	4.1 .161	282876-3

Note: All part numbers are RoHS Compliant.

Board Mount, Three-Levels Stacking Connectors

Board Mount w/Interlock
5.0 mm Centerline,
Three Levels, Stacking
Color – Green
UL Rating – 300 V, 24 A
12-30 AWG
20 A for field wiring applications

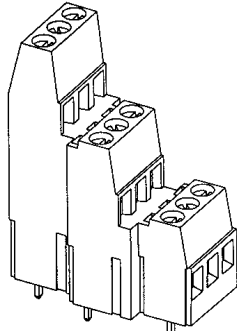

Suggested Screw Torque—
 7.0 in.-lb.

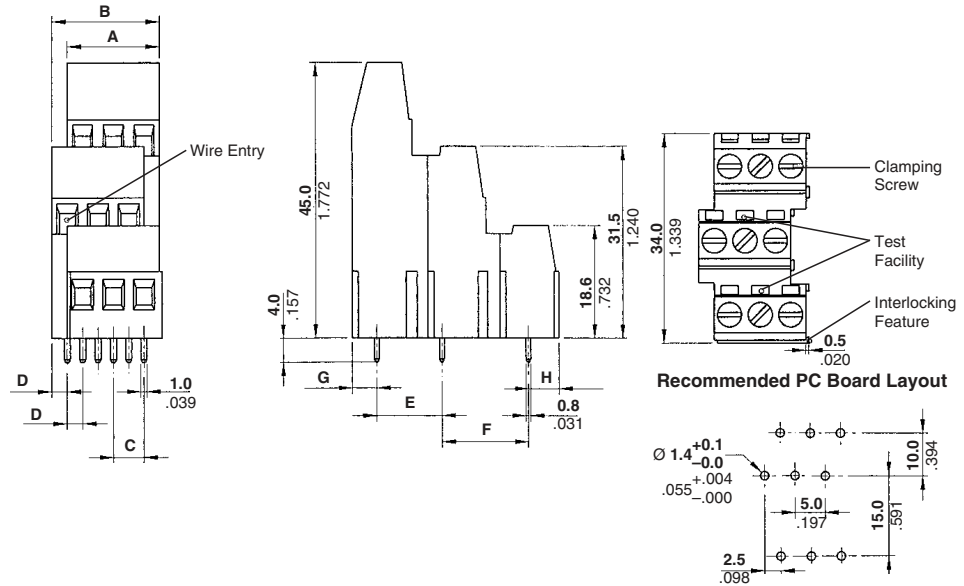

No. of Positions	Dimensions								Part Numbers
	A	B	C	D	E	F	G	H	
2	10.0 .394	12.5 .492	5.0 .197	2.5 .098	10.0 .394	15.0 .591	4.0 .157	5.0 .197	282916-2
3	15.0 .591	17.5 .689	5.0 .197	2.5 .098	10.0 .394	15.0 .591	4.0 .157	5.0 .197	282916-3

Board Mount w/Interlock
5.08 mm Centerline,
Three Levels, Stacking
Color – Green
UL Rating – 300 V, 13.5 A
16-30 AWG
10 A for field wiring applications

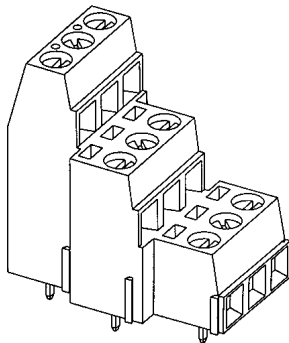

Suggested Screw Torque—
 6.0 in.-lb.

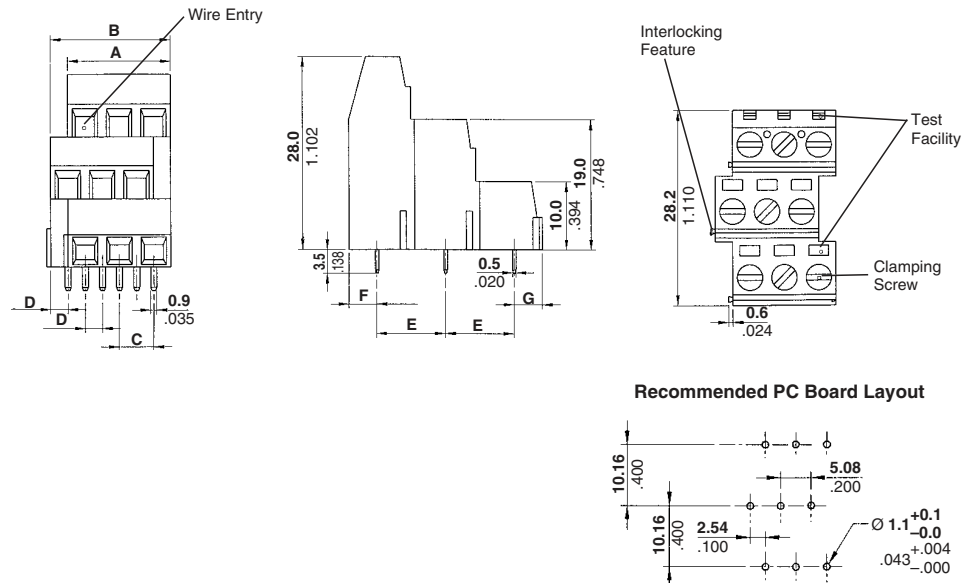

No. of Positions	Dimensions							Part Number
	A	B	C	D	E	F	G	
2	10.16 .400	12.70 .500	5.08 .200	2.54 .100	10.16 .400	3.78 .149	4.1 .161	282877-2
3	15.24 .100	17.78 .700	5.08 .200	2.54 .100	10.16 .400	3.78 .149	4.1 .161	282877-3

Note: All part numbers are RoHS Compliant.

Board Mount, Three-Levels Stacking Connectors (Continued)

Board Mount w/Interlock
5.08 mm Centerline,
Three Levels, Stacking
UL Rating – 300 V, 17.5 A
12-30 AWG
15 A for field wiring applications

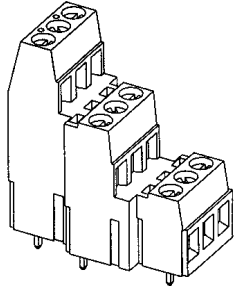

Suggested Screw Torque—
 7.0 in.-lb.

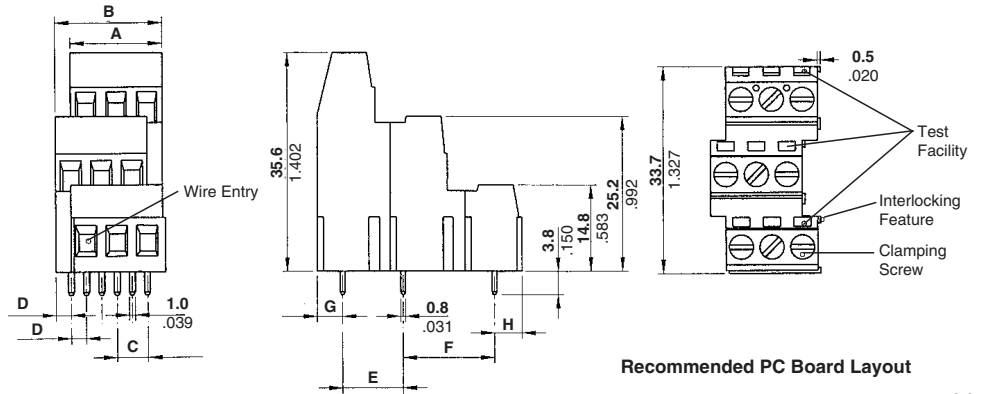

Recommended PC Board Layout

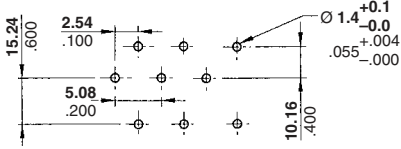

No. of Positions	Dimensions								Part Numbers	
	A	B	C	D	E	F	G	H	Green	Black
2	10.16	12.70	5.08	2.54	10.16	15.24	3.8	4.5	282897-2	1546233-2
	.400	.500	.200	.100	.400	.600	.150	.177		
3	15.24	17.78	5.08	2.54	10.16	15.24	3.8	4.5	282897-3	1546233-3
	.600	.700	.200	.100	.400	.600	.150	.177		

Board Mount w/Interlock
5.08 mm Centerline,
Three Levels, Stacking
Color – Green
UL Rating – 300 V, 24 A
12-30 AWG
20 A for field wiring applications

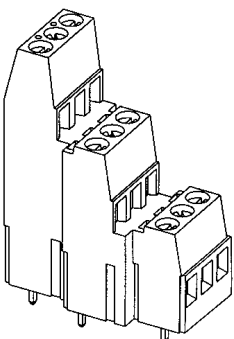

Suggested Screw Torque—
 7.0 in.-lb.

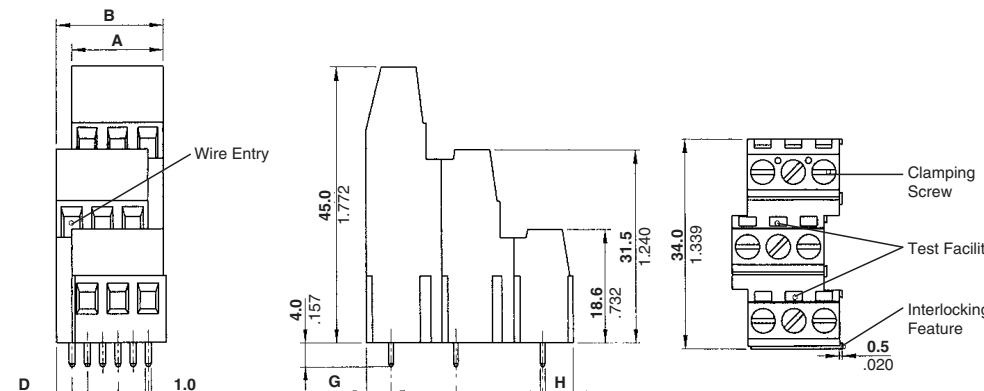

Recommended PC Board Layout

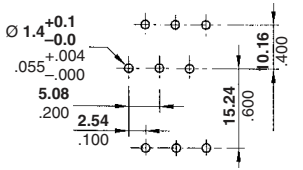

No. of Positions	Dimensions								Part Numbers
	A	B	C	D	E	F	G	H	
2	10.16	12.70	5.08	2.54	10.16	15.24	3.6	5.0	282917-2
	.400	.500	.200	.100	.400	.600	.142	.197	
3	15.24	17.78	5.08	2.54	10.16	15.24	3.6	5.0	282917-3
	.600	.700	.200	.100	.400	.600	.142	.197	



Note: All part numbers are RoHS Compliant.

Board Mount, 2nd Level Stacking Connectors

Board Mount w/Interlock
5.0 mm Centerline,
2nd Level, Stacking
Color – Green

UL Rating – 300 V, 13.5 A
16-30 AWG
10 A for field wiring applications

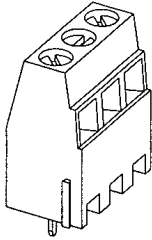

Suggested Screw Torque—
 6.0 in.-lb.

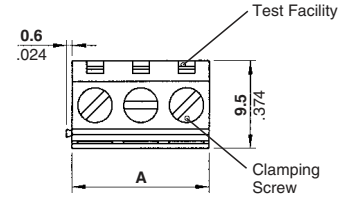
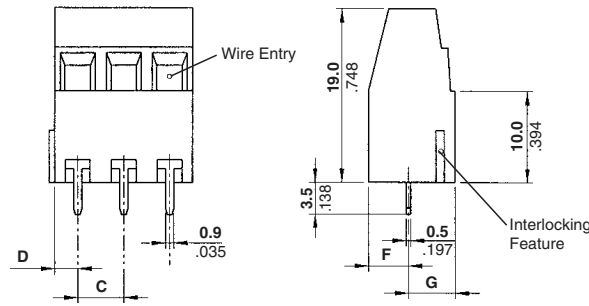

Recommended PC Board Layout

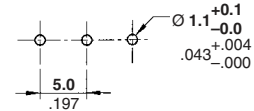

No. of Positions	Dimensions					Part Numbers
	A	C	D	F	G	
2	10.0 .394	5.0 .197	2.5 .098	4.4 .173	5.1 .201	282880-2
3	15.0 .591	5.0 .197	2.5 .098	4.4 .173	5.1 .201	282880-3

Board Mount w/Interlock
5.0 mm Centerline,
2nd Level, Stacking
Color – Green

UL Rating – 300 V, 17.5 A
12-30 AWG
15 A for field wiring applications

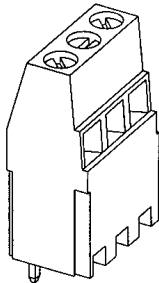

Suggested Screw Torque—
 7.0 in.-lb.

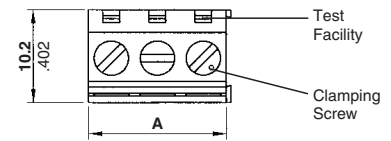
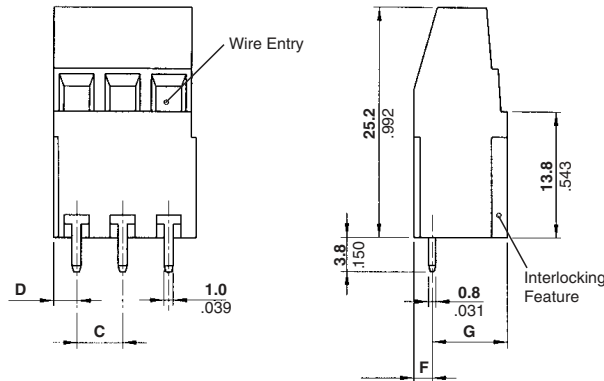

Recommended PC Board Layout

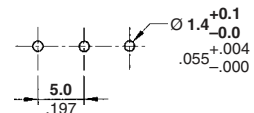

No. of Positions	Dimensions					Part Numbers
	A	C	D	F	G	
2	10.0 .394	5.0 .197	2.5 .098	2.0 .079	8.2 .323	282900-2
3	15.0 .591	5.0 .197	2.5 .098	2.0 .079	8.2 .323	282900-3

Note: All part numbers are RoHS Compliant.

Board Mount, 2nd Level Stacking Connectors (Continued)

Board Mount w/Interlock
5.0 mm Centerline,
2nd Level, Stacking
Color – Green
UL Rating – 300 V, 24 A
12-30 AWG
20 A for field wiring applications

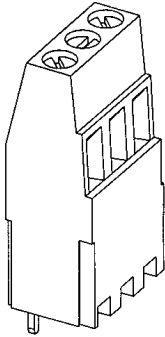

Suggested Screw Torque—
 7.0 in.-lb.

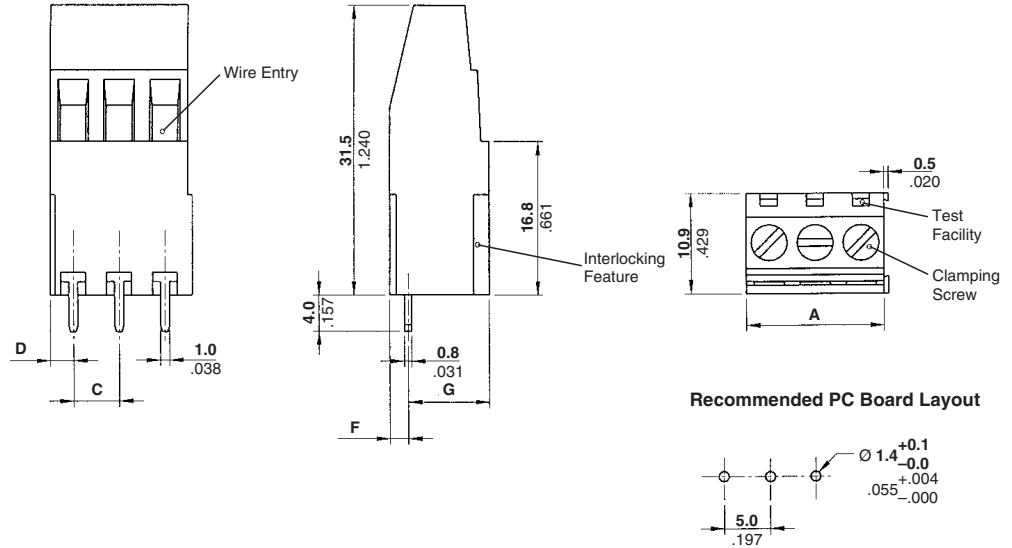

No. of Positions	Dimensions					Part Numbers
	A	C	D	F	G	
2	10.0 .394	5.0 .197	2.5 .098	2.0 .079	8.9 .350	282920-2
3	15.0 .591	5.0 .197	2.5 .098	2.0 .079	8.9 .350	282920-3

Board Mount w/Interlock
5.08 mm Centerline,
2nd Level, Stacking
Color – Green
UL Rating – 300 V, 13.5 A
16-30 AWG
10 A for field wiring applications

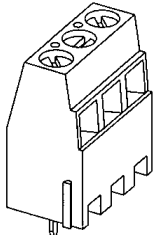

Suggested Screw Torque—
 6.0 in.-lb.

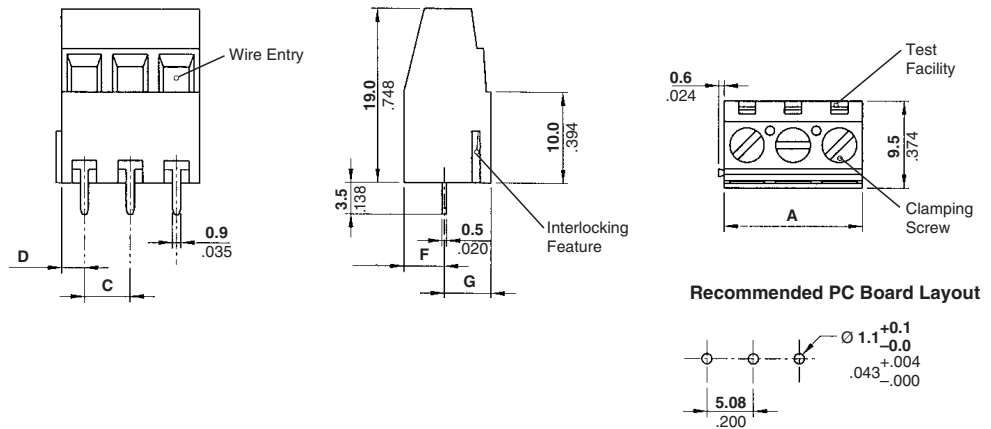

No. of Positions	Dimensions					Part Numbers
	A	C	D	F	G	
2	10.16 .400	5.08 .200	2.54 .100	4.24 .167	5.26 .207	282881-2
3	15.24 .600	5.08 .200	2.54 .100	4.24 .167	5.26 .207	282881-3



Note: All part numbers are RoHS Compliant.

Board Mount, 2nd Level Stacking Connectors (Continued)

Board Mount w/Interlock
5.08 mm Centerline,
2nd Level, Stacking
Color – Green
UL Rating – 300 V, 17.5 A
12-30 AWG
15 A for field wiring applications

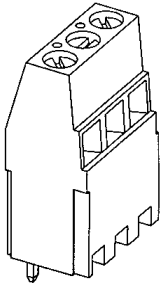

Suggested Screw Torque—
 7.0 in.-lb.

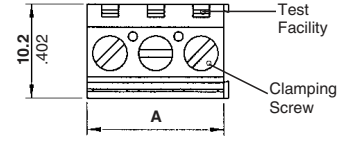
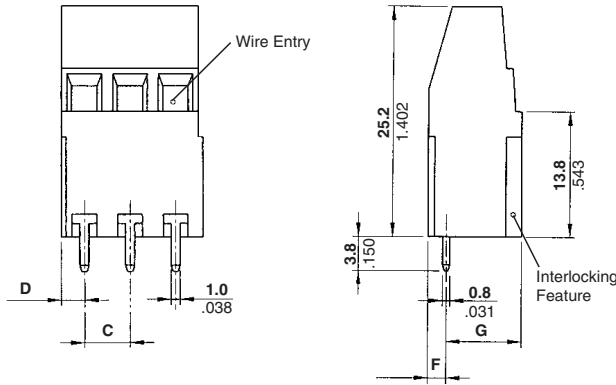

Recommended PC Board Layout

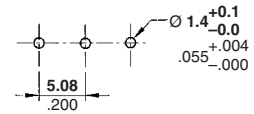

No. of Positions	Dimensions					Part Numbers
	A	C	D	F	G	
2	10.16 .400	5.08 .200	2.54 .100	1.76 .069	8.44 .332	282901-2
3	15.24 .600	5.08 .200	2.54 .100	1.76 .069	8.44 .332	282901-3

Board Mount w/Interlock
5.08 mm Centerline,
2nd Level, Stacking
Color – Green
UL Rating – 300 V, 24 A
12-30 AWG
20 A for field wiring applications

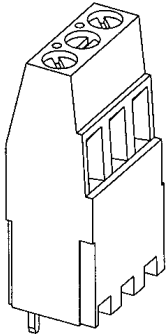

Suggested Screw Torque—
 7.0 in.-lb.

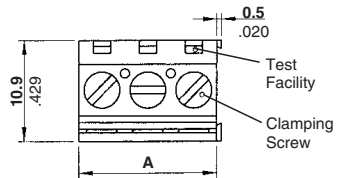
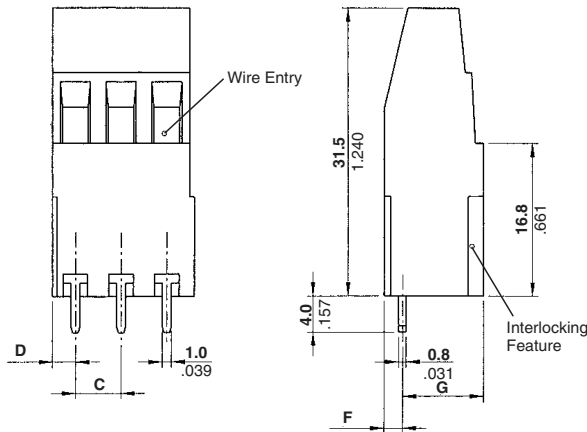

Recommended PC Board Layout

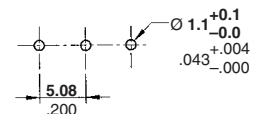

No. of Positions	Dimensions					Part Numbers
	A	C	D	F	G	
2	10.16 .400	5.08 .200	2.54 .100	1.76 .069	9.14 .360	282921-2
3	15.24 .600	5.08 .200	2.54 .100	1.76 .069	9.14 .360	282921-3

Note: All part numbers are RoHS Compliant.

Board Mount, 3rd Level Stacking Connectors

Board Mount w/Interlock
5.0 mm Centerline,
3rd Level, Stacking
Color – Green
UL Rating – 300 V, 13.5 A
16-30 AWG
10 A for field wiring applications

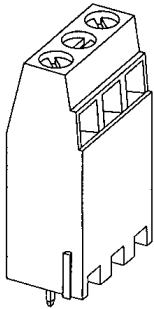

Suggested Screw Torque—
 6.0 in.-lb.

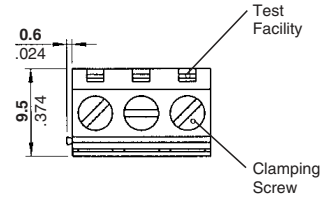
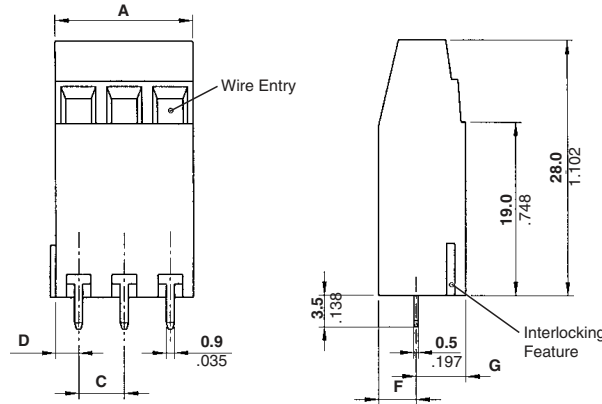

Recommended PC Board Layout

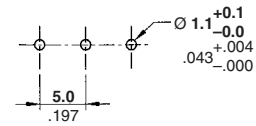

No. of Positions	Dimensions					Part Numbers
	A	C	D	F	G	
2	10.0 .394	5.0 .197	2.5 .098	4.1 .173	5.4 .213	282884-2
3	15.0 .591	5.0 .197	2.5 .098	4.1 .173	5.4 .213	282884-3

Board Mount w/Interlock
5.0 mm Centerline,
3rd Level, Stacking
Color – Green
UL Rating – 300 V, 24 A
12-30 AWG
20 A for field wiring applications

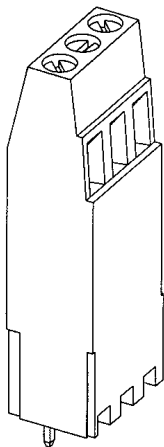

Suggested Screw Torque—
 7.0 in.-lb.

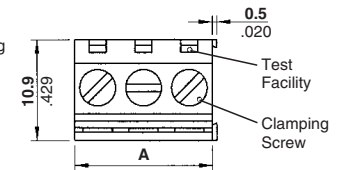
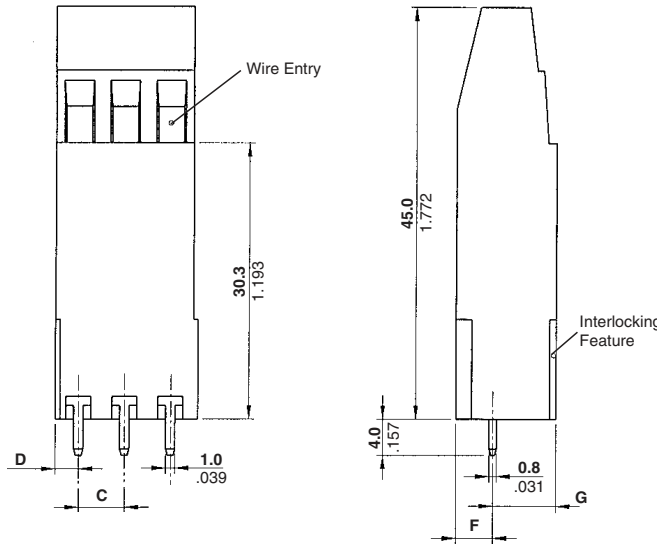

Recommended PC Board Layout

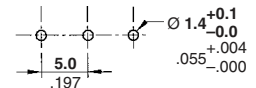

No. of Positions	Dimensions					Part Numbers
	A	C	D	F	G	
2	10.0 .394	5.0 .197	2.5 .098	4.0 .157	6.9 .272	282924-2
3	15.0 .591	5.0 .197	2.5 .098	4.0 .157	6.9 .272	282924-3

Note: All part numbers are RoHS Compliant.

Board Mount, 3rd Level Stacking Connectors (Continued)

Board Mount w/Interlock
5.08 mm Centerline,
3rd Level, Stacking
Color – Green

UL Rating – 300 V, 17.5 A
12-30 AWG
15 A for field wiring applications

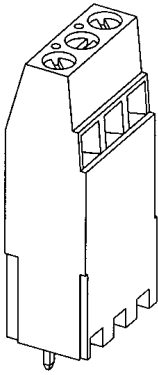

Suggested Screw Torque—
 7.0 in.-lb.

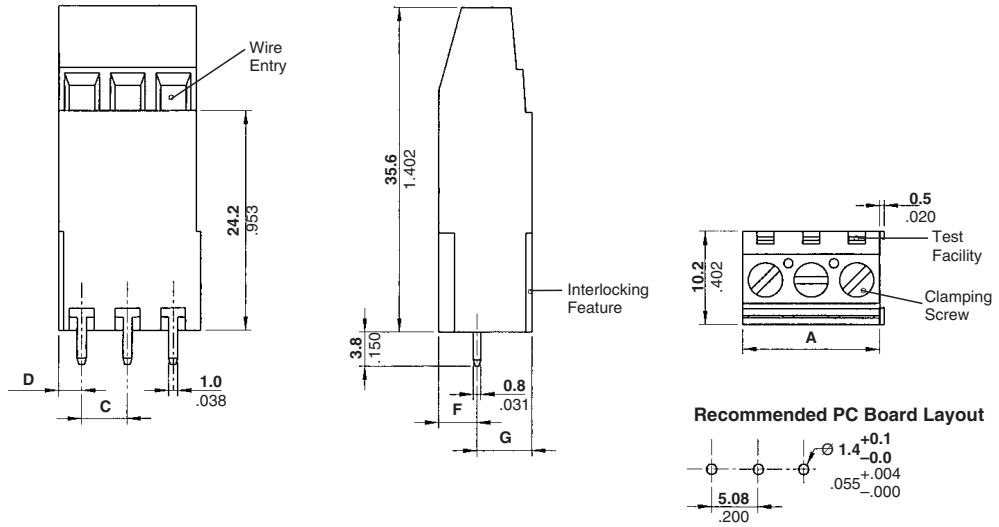

No. of Positions	Dimensions					Part Numbers
	A	C	D	F	G	
2	10.16 .400	5.08 .200	2.54 .100	3.8 .150	6.4 .252	282905-2
3	15.24 .600	5.08 .200	2.54 .100	3.8 .150	6.4 .252	282905-3

Board Mount w/Interlock
5.08 mm Centerline,
3rd Level, Stacking
Color – Green

UL Rating – 300 V, 24 A
12-30 AWG
20 A for field wiring applications

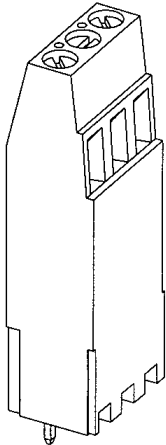

Suggested Screw Torque—
 7.0 in.-lb.

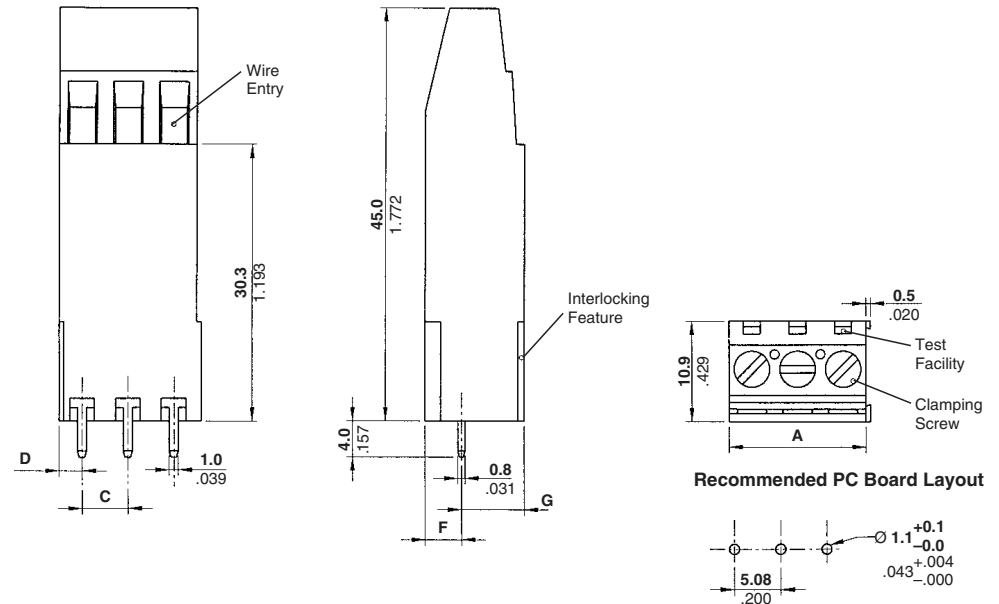

No. of Positions	Dimensions					Part Number
	A	C	D	F	G	
2	10.16 .400	5.08 .200	2.54 .100	3.6 .142	7.3 .287	282925-2
3	15.24 .600	5.08 .200	2.54 .100	3.6 .142	7.3 .287	282925-3

Note: All part numbers are RoHS Compliant.

Board Mount, 3rd Level Stacking Connectors (Continued)

Board Mount w/Interlock
10.0 mm Centerline,
3rd Level, Stacking
Color – Green

UL Rating – 600 V, 17.5 A
16-30 AWG
15 A for field wiring applications

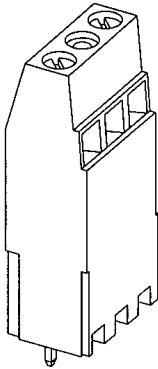

Suggested Screw Torque—
7.0 in.-lb.

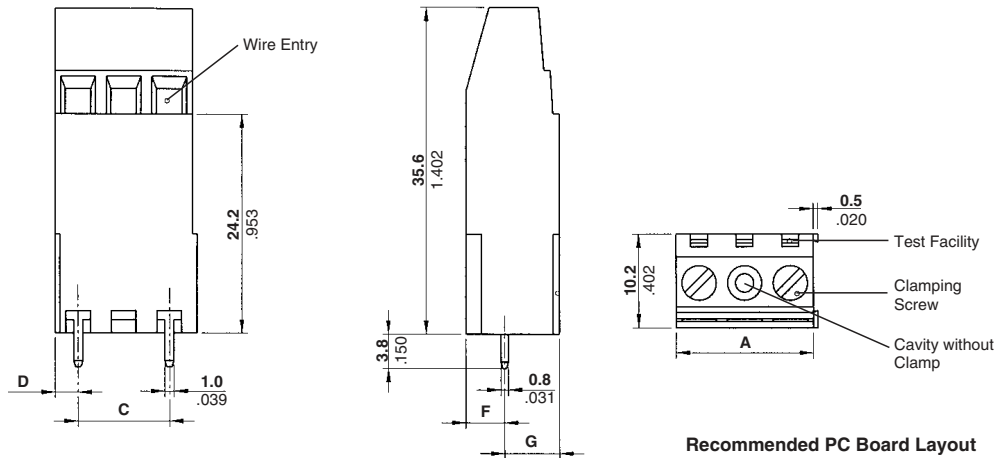

Recommended PC Board Layout

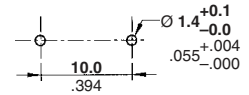

No. of Positions	Dimensions					Part Number
	A	C	D	F	G	
2	15.0 .591	10.0 .394	2.5 .098	4.2 .165	6.0 .236	282906-2



Two-Piece Terminal Block Connectors

Two-Piece Terminal Block Connectors

Tyco Electronics currently provides a full range of two-piece modular terminal blocks for headers with 3.5, 3.81, 5.0, 5.08, 7.5, 7.62, 10.0 and 10.16 mm centerline.

Product Facts

- n 3.5, 3.81, 5.0, 5.08, 7.5, 7.62, 10.0 and 10.16 mm centerlines
- n Straight and right-angle shrouded headers with open or closed ends
- n Double-sided female contact design
- n Built-in interlocks to assemble higher number of ways
- n Retention latches between plug and header
- n Polarization keys for easier mating
- n Special 90°/180° and 90°/270° Plugs and Unshrouded Headers (5.0 and 10.0mm Centerline)
- n Interchangeable with existing products of most terminal block suppliers
- n PC board footprint fully compatible with existing Industry Standards: pc board thickness 1.6–2.4 mm
- n 2-3-4 way modules with interlocking fixture, 3.5, 3.81, 5.0 and 5.08 mm centerline, to assemble higher number of ways
- n Polarizing keys promote proper mating (see page 108 for keys and page 107 for labeling)
- n Straight and right-angle headers
- n Stackable open end headers
- n Closed end headers
- n Retention latch between plug and header housings
- n Rising cage clamp design
- n Double-sided contact spring
- n Funnel entry plug housing for easier wire insertion
- n Captive screw
- n Plugs supplied with open screw

- n **Screw flange versions available on 3.5, 3.81, 5.0, and 5.08 mm centerlines**
- n **5.0 and 10.0 mm centerlines**
- n **Recognized under the Component Program of Underwriters Laboratories Inc., File No. E60677** 
- n **Certified by Canadian Standards Association, File No. 703157** 
- n **Interchangeable with most existing products**
- n **PC board footprint compatible with the existing Industry Standards**
- n **Rising cage clamp design**
- n **Funnel entry housing for easier wire insertion**
- n **Test probe access**
- n **Terminal blocks supplied with open captive screws**
- n **Adhesive labeling for numbering**

Housing Material—Polyamide 6/6, UL 94V-0 rated

Male Contact—Brass, tin plated

Female Contact—Phosphor bronze, tin plated

Screw Clamp—Brass, nickel plated

Screw—Brass, nickel plated

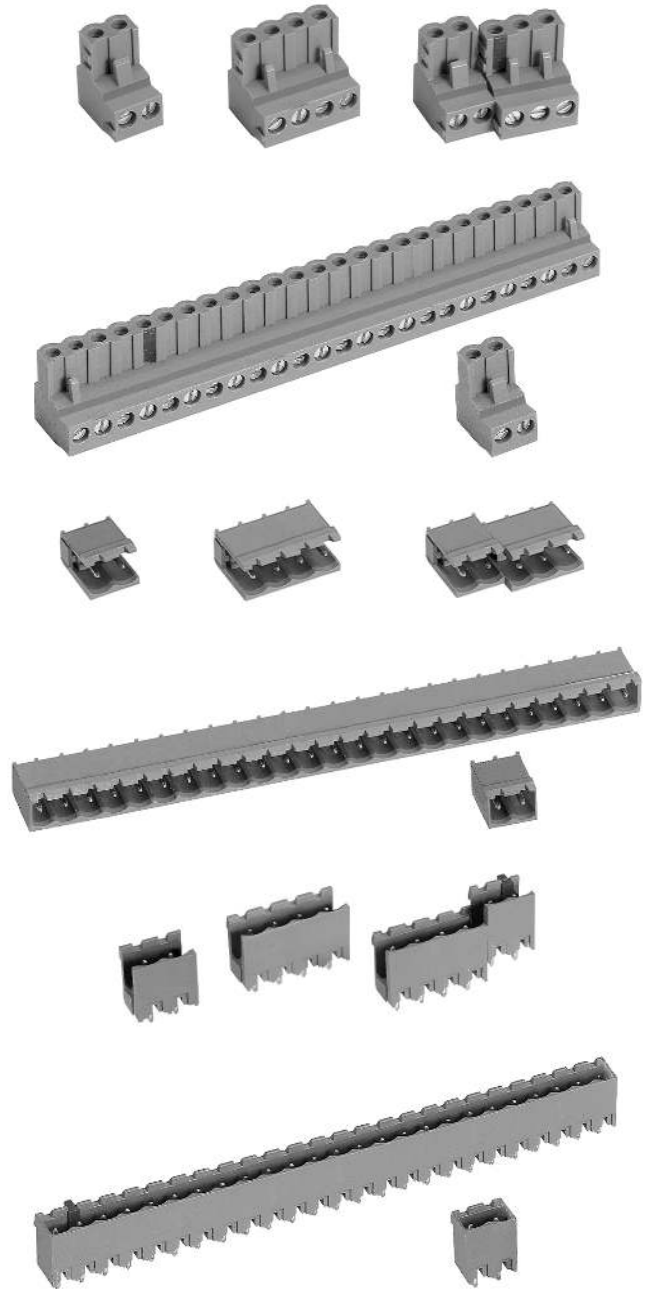

Two-Piece Header and Plug

Centerline	No. of Positions
3.50 [.138]*	2–25
3.81 [.150]*	2–25
5.00 [.197]*	2–25
5.08 [.200]*	2–25
7.50 [.295]	2–12
7.62 [.300]	2–12
10.00 [.394]	2–13
10.16 [.400]	2–13

*Flanged versions may not reflect standard position size.

Note: All part numbers are RoHS Compliant.

Two-Piece Terminal Block Connectors (Continued)

Straight Header w/Threaded Flange, 3.5 mm Centerline
UL Rating – 300 V, 11 A

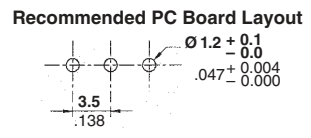
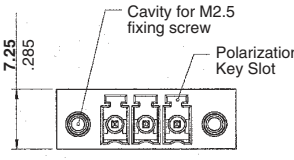
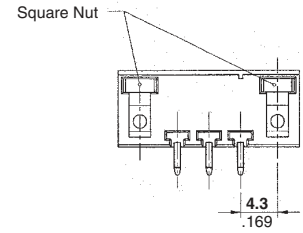
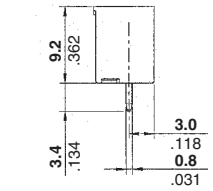
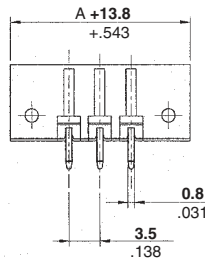
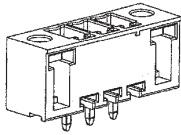

No. of Positions	Dim. A	Part Numbers	
		Green	Black*
2	3.5 [0.138]	284516-2	1776132-2
3	7.0 [0.276]	284516-3	1776132-3
4	10.5 [0.413]	284516-4	1776132-4
5	14.0 [0.551]	284516-5	1776132-5
6	17.5 [0.689]	284516-6	1776132-6
7	21.0 [0.827]	284516-7	1776132-7
8	24.5 [0.965]	284516-8	1776132-8
9	28.0 [1.102]	284516-9	1776132-9
10	31.5 [1.240]	1-284516-0	1-1776132-0
11	35.0 [1.378]	1-284516-1	1-1776132-1
12	38.5 [1.516]	1-284516-2	1-1776132-2

No. of Positions	Dim. A	Part Numbers	
		Green	Black*
13	42.0 [1.654]	1-284516-3	—
14	45.5 [1.791]	1-284516-4	—
15	49.0 [1.929]	1-284516-5	—
16	52.5 [2.067]	1-284516-6	—
17	56.0 [2.205]	1-284516-7	—
18	59.5 [2.343]	1-284516-8	—
19	63.0 [2.480]	1-284516-9	—
20	66.5 [2.618]	2-284516-0	—
21	70.0 [2.756]	2-284516-1	—
22	73.5 [2.894]	2-284516-2	—
23	77.0 [3.031]	2-284516-3	—

*Wave solder process capable to 265°C [509°F] for 10 seconds. Dimensions may vary from what is shown for High Temperature Parts. Please check Customer Drawing.

Straight Header w/Threaded Flange, 3.81 mm Centerline
UL Rating – 300 V, 11 A

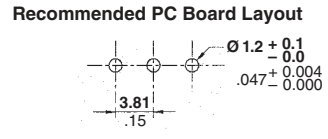
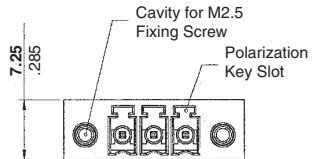
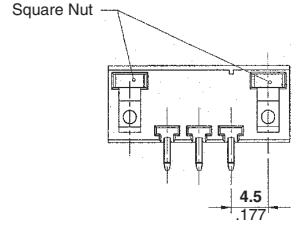
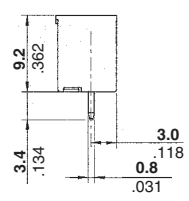
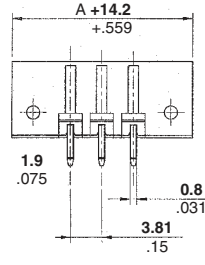
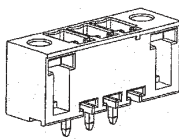

No. of Positions	Dim. A	Part Numbers	
		Green	Black*
2	3.81 [0.15]	284519-2	1776133-2
3	7.62 [0.30]	284519-3	1776133-3
4	11.43 [0.45]	284519-4	1776133-4
5	15.24 [0.60]	284519-5	1776133-5
6	19.05 [0.75]	284519-6	1776133-6
7	22.86 [0.90]	284519-7	1776133-7
8	26.67 [1.05]	284519-8	1776133-8
9	30.48 [1.20]	284519-9	1776133-9
10	34.29 [1.35]	1-284519-0	1-1776133-0
11	38.10 [1.50]	1-284519-1	1-1776133-1
12	41.91 [1.65]	1-284519-2	1-1776133-2

No. of Positions	Dim. A	Part Numbers	
		Green	Black*
13	45.72 [1.80]	1-284519-3	—
14	49.53 [1.95]	1-284519-4	—
15	53.34 [2.10]	1-284519-5	—
16	57.15 [2.25]	1-284519-6	—
17	60.96 [2.40]	1-284519-7	—
18	64.77 [2.55]	1-284519-8	—
19	68.58 [2.70]	1-284519-9	—
20	72.39 [2.85]	2-284519-0	—
21	76.20 [3.00]	2-284519-1	—
22	80.01 [3.15]	2-284519-2	—
23	83.82 [3.30]	2-284519-3	—

*Wave solder process capable to 265°C [509°F] for 10 seconds. Dimensions may vary from what is shown for High Temperature Parts. Please check Customer Drawing.



Note: All part numbers are RoHS Compliant.

Two-Piece Terminal Block Connectors (Continued)

**Straight Header w/Locking
Screw Flange,
5.08 mm Centerline,
Color – Green
UL Rating – 300 V, 15 A**

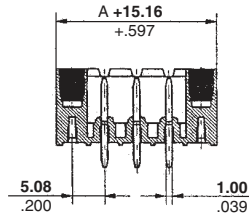
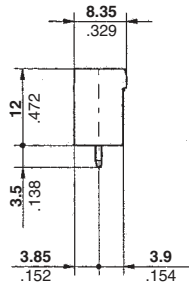

Recommended PC Board Layout

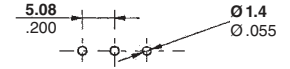

No. of Positions	Dim. A	Part Numbers
2	5.08 [0.20]	796867-2
3	10.16 [0.40]	796867-3
4	15.24 [0.60]	796867-4
5	20.32 [0.80]	796867-5
6	25.40 [1.00]	796867-6
7	30.48 [1.20]	796867-7
8	35.56 [1.40]	796867-8
9	40.64 [1.60]	796867-9
10	45.72 [1.80]	1-796867-0
11	50.80 [2.00]	1-796867-1
12	55.88 [2.20]	1-796867-2

No. of Positions	Dim. A	Part Numbers
13	60.96 [2.40]	1-796867-3
14	66.04 [2.60]	1-796867-4
15	71.12 [2.80]	1-796867-5
16	76.20 [3.00]	1-796867-6
17	81.28 [3.20]	1-796867-7
18	86.36 [3.40]	1-796867-8
19	91.44 [3.60]	1-796867-9
20	96.52 [3.80]	2-796867-0
21	101.60 [4.00]	2-796867-1
22	106.68 [4.20]	2-796867-2
23	111.76 [4.40]	2-796867-3

Note: All part numbers are RoHS Compliant.

Two-Piece Terminal Block Connectors (Continued)

Right-Angle Closed End Header w/Threaded Flange, 3.5 mm Centerline
UL Rating – 300 V, 11 A

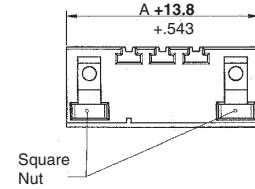
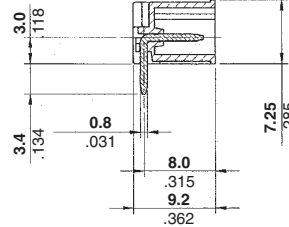
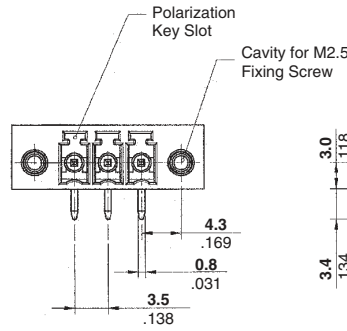
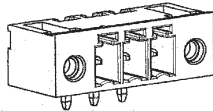

Recommended PC Board Layout

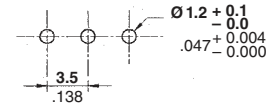

No. of Positions	Dim. A	Part Numbers	
		Green	Black*
2	3.5 [0.138]	284539-2	1776136-2
3	7.0 [0.276]	284539-3	1776136-3
4	10.5 [0.413]	284539-4	1776136-4
5	14.0 [0.551]	284539-5	1776136-5
6	17.5 [0.689]	284539-6	1776136-6
7	21.0 [0.827]	284539-7	1776136-7
8	24.5 [0.965]	284539-8	1776136-8
9	28.0 [1.102]	284539-9	1776136-9
10	31.5 [1.240]	1-284539-0	1-1776136-0
11	35.0 [1.378]	1-284539-1	1-1776136-1
12	38.5 [1.516]	1-284539-2	1-1776136-2

No. of Positions	Dim. A	Part Numbers	
		Green	Black*
13	42.0 [1.654]	1-284539-3	—
14	45.5 [1.791]	1-284539-4	—
15	49.0 [1.929]	1-284539-5	—
16	52.5 [2.067]	1-284539-6	—
17	56.0 [2.205]	1-284539-7	—
18	59.5 [2.343]	1-284539-8	—
19	63.0 [2.480]	1-284539-9	—
20	66.5 [2.618]	2-284539-0	—
21	70.0 [2.756]	2-284539-1	—
22	73.5 [2.894]	2-284539-2	—
23	77.0 [3.031]	2-284539-3	—

*Wave solder process capable to 265°C [509°F] for 10 seconds. Dimensions may vary from what is shown for High Temperature Parts. Please check Customer Drawing.

Right-Angle Closed End Header w/Threaded Flange, 3.81 mm Centerline
UL Rating – 300 V, 11 A

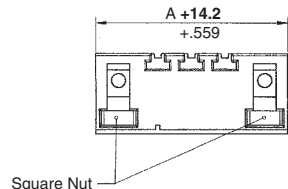
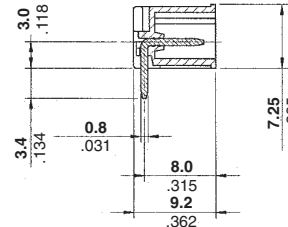
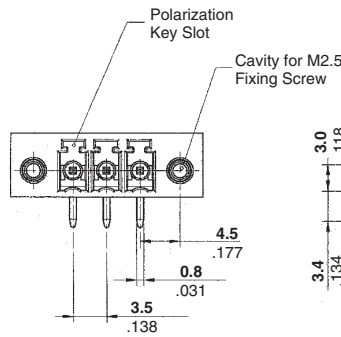
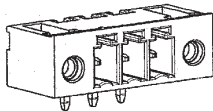

Recommended PC Board Layout

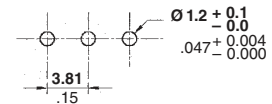

No. of Positions	Dim. A	Part Numbers	
		Green	Black*
2	3.81 [0.15]	284541-2	1776137-2
3	7.62 [0.30]	284541-3	1776137-3
4	11.43 [0.45]	284541-4	1776137-4
5	15.24 [0.60]	284541-5	1776137-5
6	19.05 [0.75]	284541-6	1776137-6
7	22.86 [0.90]	284541-7	1776137-7
8	26.67 [1.05]	284541-8	1776137-8
9	30.48 [1.20]	284541-9	1776137-9
10	34.29 [1.35]	1-284541-0	1-1776137-0
11	38.10 [1.50]	1-284541-1	1-1776137-1
12	41.91 [1.65]	1-284541-2	1-1776137-2

No. of Positions	Dim. A	Part Numbers	
		Green	Black*
13	45.72 [1.80]	1-284541-3	—
14	49.53 [1.95]	1-284541-4	—
15	53.34 [2.10]	1-284541-5	—
16	57.15 [2.25]	1-284541-6	—
17	60.96 [2.40]	1-284541-7	—
18	64.77 [2.55]	1-284541-8	—
19	68.58 [2.70]	1-284541-9	—
20	72.39 [2.85]	2-284541-0	—
21	76.20 [3.00]	2-284541-1	—
22	80.01 [3.15]	2-284541-2	—
23	83.82 [3.30]	2-284541-3	—

*Wave solder process capable to 265°C [509°F] for 10 seconds. Dimensions may vary from what is shown for High Temperature Parts. Please check Customer Drawing.



Two-Piece Terminal Block Connectors (Continued)

Right-Angle Header w/Locking Screw Flange, 5.0 mm Centerline, Color – Green
UL Rating – 300 V, 15 A

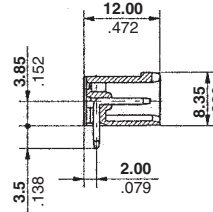
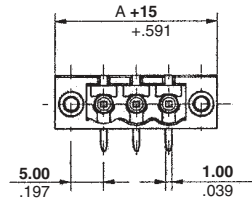
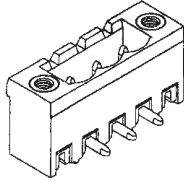

Recommended PC Board Layout

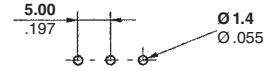

No. of Positions	Dim. A	Part Numbers
2	5.0 [0.197]	796864-2
3	10.0 [0.394]	796864-3
4	15.0 [0.591]	796864-4
5	20.0 [0.787]	796864-5
6	25.0 [0.984]	796864-6
7	30.0 [1.181]	796864-7
8	35.0 [1.378]	796864-8

Right-Angle Header w/Locking Screw Flange, 5.08 mm Centerline, Color – Green
UL Rating – 300 V, 15 A

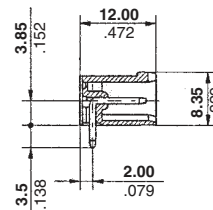
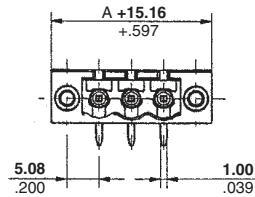
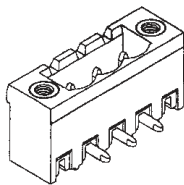

Recommended PC Board Layout

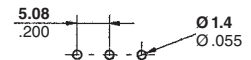

No. of Positions	Dim. A	Part Numbers
2	5.08 [0.20]	796866-2
3	10.16 [0.40]	796866-3
4	15.24 [0.60]	796866-4
5	20.32 [0.80]	796866-5
6	25.40 [1.00]	796866-6
7	30.48 [1.20]	796866-7
8	35.56 [1.40]	796866-8
9	40.64 [1.60]	796866-9
10	45.72 [1.80]	1-796866-0
11	50.80 [2.00]	1-796866-1
12	55.88 [2.20]	1-796866-2

No. of Positions	Dim. A	Part Numbers
13	60.96 [2.40]	1-796866-3
14	66.04 [2.60]	1-796866-4
15	71.12 [2.80]	1-796866-5
16	76.20 [3.00]	1-796866-6
17	81.28 [3.20]	1-796866-7
18	86.36 [3.40]	1-796866-8
19	91.44 [3.60]	1-796866-9
20	96.52 [3.80]	2-796866-0
21	101.60 [4.00]	2-796866-1
22	106.68 [4.20]	2-796866-2
23	111.76 [4.40]	2-796866-3

Note: All part numbers are RoHS Compliant.

Two-Piece Terminal Block Connectors (Continued)

Straight, Open End Headers, 3.5 mm Centerline

UL Rating – 300 V, 11 A

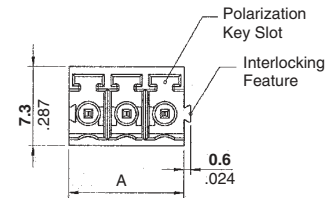
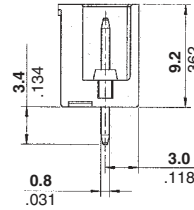
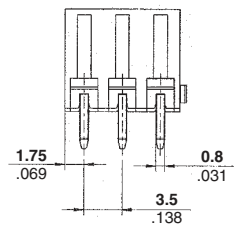
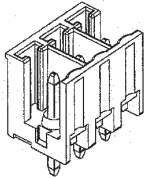

Recommended PC Board Layout

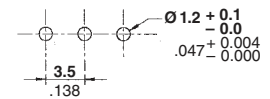

No. of Positions	Dim. A	Part Numbers Green
2	7.0 [0.276]	284515-2
3	10.5 [0.413]	284515-3
4	14.0 [0.551]	284515-4
5	17.5 [0.689]	284515-5
6	21.0 [0.827]	284515-6
7	24.5 [0.965]	284515-7
8	28.0 [1.102]	284515-8
9	31.5 [1.240]	284515-9
10	35.0 [1.378]	1-284515-0
11	38.5 [1.516]	1-284515-1
12	42.0 [1.654]	1-284515-2
13	45.5 [1.791]	1-284515-3

No. of Positions	Dim. A	Part Numbers Green
14	49.0 [1.929]	1-284515-4
15	52.5 [2.067]	1-284515-5
16	56.0 [2.205]	1-284515-6
17	59.5 [2.343]	1-284515-7
18	63.0 [2.480]	1-284515-8
19	66.5 [2.618]	1-284515-9
20	70.0 [2.756]	2-284515-0
21	73.5 [2.894]	2-284515-1
22	77.0 [3.031]	2-284515-2
23	80.5 [3.169]	2-284515-3
24	84.0 [3.307]	2-284515-4
25	87.5 [3.445]	2-284515-5

Straight, Closed End Headers, 3.5 mm Centerline

UL Rating – 300 V, 11 A

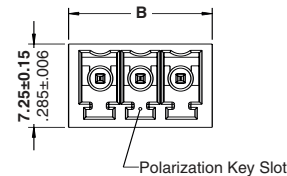
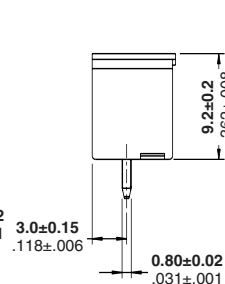
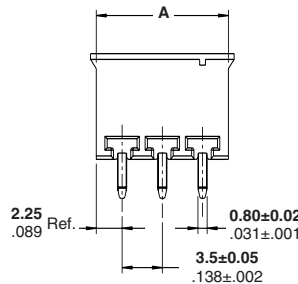
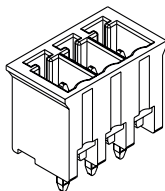

Recommended PC Board Layout

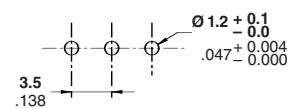

Number of Positions	Dimensions		Part Numbers		
	A	B	Green	Blue	Black*
2	8.0 [0.315]	9.0 [0.354]	284514-2	796694-2	1776130-2
3	11.5 [0.453]	12.5 [0.492]	284514-3	796694-3	1776130-3
4	15.0 [0.590]	16.0 [0.630]	284514-4	796694-4	1776130-4
5	18.5 [0.728]	19.5 [0.768]	284514-5	796694-5	1776130-5
6	22.0 [0.866]	23.0 [0.906]	284514-6	796694-6	1776130-6
7	25.5 [1.004]	26.5 [1.043]	284514-7	796694-7	1776130-7
8	29.0 [1.142]	30.0 [1.181]	284514-8	796694-8	1776130-8
9	32.5 [1.280]	33.5 [1.319]	284514-9	796694-9	1776130-9
10	36.0 [1.417]	37.0 [1.457]	1-284514-0	1-796694-0	1-1776130-0
11	39.5 [1.555]	40.5 [1.594]	1-284514-1	1-796694-1	1-1776130-1
12	43.0 [1.693]	44.0 [1.732]	1-284514-2	1-796694-2	1-1776130-2
13	46.5 [1.831]	47.5 [1.870]	1-284514-3	1-796694-3	—

Number of Positions	Dimensions		Part Numbers		
	A	B	Green	Blue	Black*
14	50.0 [1.968]	51.0 [2.008]	1-284514-4	1-796694-4	—
15	53.5 [2.106]	54.5 [2.146]	1-284514-5	1-796694-5	—
16	57.0 [2.244]	58.0 [2.283]	1-284514-6	1-796694-6	—
17	60.5 [2.382]	61.5 [2.421]	1-284514-7	1-796694-7	—
18	64.0 [2.520]	65.0 [2.599]	1-284514-8	1-796694-8	—
19	67.5 [2.657]	68.5 [2.697]	1-284514-9	1-796694-9	—
20	71.0 [2.795]	72.0 [2.835]	2-284514-0	2-796694-0	—
21	74.5 [2.933]	75.5 [2.972]	2-284514-1	2-796694-1	—
22	78.0 [3.071]	79.0 [3.110]	2-284514-2	2-796694-2	—
23	81.5 [3.209]	82.5 [3.248]	2-284514-3	2-796694-3	—
24	85.0 [3.346]	86.0 [3.386]	2-284514-4	2-796694-4	—
25	88.5 [3.484]	89.5 [3.524]	2-284514-5	2-796694-5	—

Note: BUCHANAN Terminal Block Series B73N3VxxT has been superseded/replaced with 796694-xx.

*Wave solder process capable to 265°C [509°F] for 10 seconds. Dimensions may vary from what is shown for High Temperature Parts. Please check Customer Drawing.



Note: All part numbers are RoHS Compliant.

Two-Piece Terminal Block Connectors (Continued)

**Straight, Open End Headers,
3.81 mm Centerline
Color – Green
UL Rating – 300 V, 11 A**

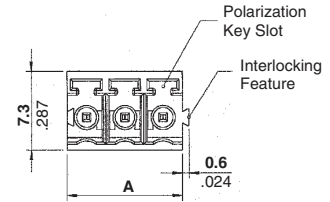
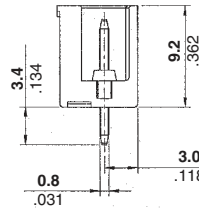
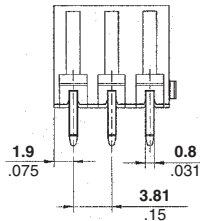
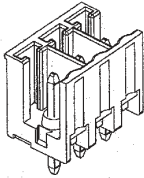

Recommended PC Board Layout

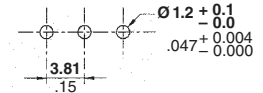

No. of Positions	Dim. A	Part Numbers
2	7.62 [0.30]	284518-2
3	11.43 [0.45]	284518-3
4	15.24 [0.60]	284518-4
5	19.05 [0.75]	284518-5
6	22.86 [0.90]	284518-6
7	26.67 [1.05]	284518-7
8	30.48 [1.20]	284518-8
9	34.29 [1.35]	284518-9
10	38.10 [1.50]	1-284518-0
11	41.91 [1.65]	1-284518-1
12	45.72 [1.80]	1-284518-2
13	49.53 [1.95]	1-284518-3

No. of Positions	Dim. A	Part Numbers
14	53.34 [2.10]	1-284518-4
15	57.15 [2.25]	1-284518-5
16	60.96 [2.40]	1-284518-6
17	64.77 [2.55]	1-284518-7
18	68.58 [2.70]	1-284518-8
19	72.39 [2.85]	1-284518-9
20	76.20 [3.00]	2-284518-0
21	80.01 [3.15]	2-284518-1
22	83.82 [3.30]	2-284518-2
23	87.63 [3.45]	2-284518-3
24	91.44 [3.60]	2-284518-4
25	95.25 [3.75]	2-284518-5

**Straight, Closed End Headers,
3.81 mm Centerline
UL Rating – 300 V, 11 A**

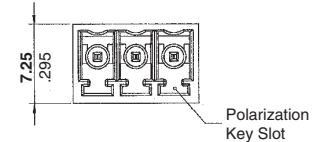
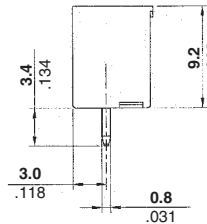
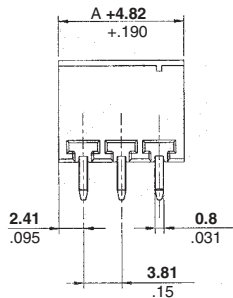
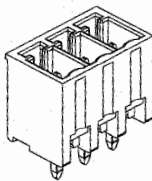

Recommended PC Board Layout

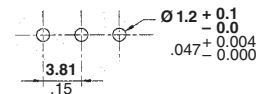

No. of Positions	Dim. A	Part Numbers	
		Green	Black*
2	3.81 [0.15]	284517-2	1776131-2
3	7.62 [0.30]	284517-3	1776131-3
4	11.43 [0.45]	284517-4	1776131-4
5	15.24 [0.60]	284517-5	1776131-5
6	19.05 [0.75]	284517-6	1776131-6
7	22.86 [0.90]	284517-7	1776131-7
8	26.67 [1.05]	284517-8	1776131-8
9	30.48 [1.20]	284517-9	1776131-9
10	34.29 [1.35]	1-284517-0	1-1776131-0
11	38.10 [1.50]	1-284517-1	1-1776131-1
12	41.91 [1.65]	1-284517-2	1-1776131-2
13	45.72 [1.80]	1-284517-3	—

No. of Positions	Dim. A	Part Numbers	
		Green	Black*
14	53.34 [2.10]	1-284517-4	—
15	57.15 [2.25]	1-284517-5	—
16	60.96 [2.40]	1-284517-6	—
17	64.77 [2.55]	1-284517-7	—
18	68.58 [2.70]	1-284517-8	—
19	72.39 [2.85]	1-284517-9	—
20	76.20 [3.00]	2-284517-0	—
21	80.01 [3.15]	2-284517-1	—
22	83.82 [3.30]	2-284517-2	—
23	87.63 [3.45]	2-284517-3	—
24	91.44 [3.60]	2-284517-4	—
25	95.25 [3.75]	2-284517-5	—

*Wave solder process capable to 265°C [509°F] for 10 seconds. Dimensions may vary from what is shown for High Temperature Parts. Please check Customer Drawing.

Note: All part numbers are RoHS Compliant.

Two-Piece Terminal Block Connectors (Continued)

Straight, Open End Stacking Headers, 5.0 mm Centerline Color – See chart.

UL Rating – 300 V, 15 A

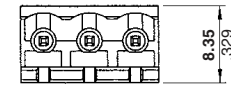
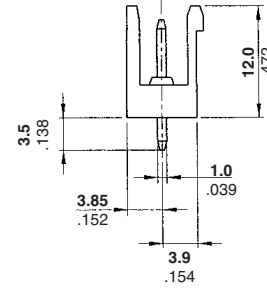
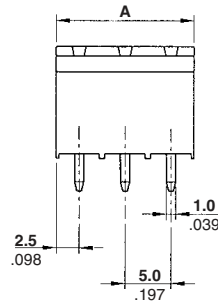
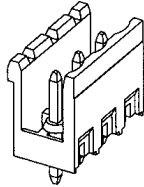

Recommended PC Board Layout

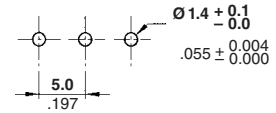

No. of Positions	Dim. A	Part Numbers				
		Gray	Green	Blue	Black*	
2	10.0 [0.394]	1546212-2	282822-2	796697-2	1776138-2	
3	15.0 [0.591]	1546212-3	282822-3	796697-3	1776138-3	
4	20.0 [0.787]	1546212-4	282822-4	796697-4	1776138-4	
5	25.0 [0.984]	1546212-5	282822-5	796697-5	1776138-5	
6	30.0 [1.181]	1546212-6	282822-6	796697-6	1776138-6	
7	35.0 [1.378]	1546212-7	282822-7	796697-7	1776138-7	
8	40.0 [1.575]	1546212-8	282822-8	796697-8	1776138-8	
9	45.0 [1.772]	1546212-9	282822-9	796697-9	1776138-9	
10	50.0 [1.968]	1-1546212-0	1-282822-0	1-796697-0	1-1776138-0	
11	55.0 [2.165]	1-1546212-1	1-282822-1	1-796697-1	1-1776138-1	
12	60.0 [2.362]	1-1546212-2	1-282822-2	1-796697-2	1-1776138-2	
13	65.0 [2.559]	1-1546212-3	1-282822-3	1-796697-3	—	

No. of Positions	Dim. A	Part Numbers				
		Gray	Green	Blue	Black*	
14	70.0 [2.756]	1-1546212-4	1-282822-4	1-796697-4	—	
15	75.0 [2.953]	1-1546212-5	1-282822-5	1-796697-5	—	
16	80.0 [3.150]	1-1546212-6	1-282822-6	1-796697-6	—	
17	85.0 [3.346]	1-1546212-7	1-282822-7	1-796697-7	—	
18	90.0 [3.543]	1-1546212-8	1-282822-8	1-796697-8	—	
19	95.0 [3.740]	1-1546212-9	1-282822-9	1-796697-9	—	
20	100.0 [3.937]	2-1546212-0	2-282822-0	2-796697-0	—	
21	105.0 [4.134]	2-1546212-1	2-282822-1	2-796697-1	—	
22	110.0 [4.331]	2-1546212-2	2-282822-2	2-796697-2	—	
23	115.0 [4.528]	2-1546212-3	2-282822-3	2-796697-3	—	
24	120.0 [4.724]	2-1546212-4	2-282822-4	2-796697-4	—	
25	125.0 [4.921]	2-1546212-5	2-282822-5	2-796697-5	—	

Note: BUCHANAN Terminal Block Series B72N4VxxT has been replaced by x-796697-x (blue).

*Wave solder process capable to 265°C [509°F] for 10 seconds. Dimensions may vary from what is shown for High Temperature Parts. Please check Customer Drawing.

Straight, Closed End Headers, 5.0 mm Centerline Color – See chart.

UL Rating – 300 V, 15 A

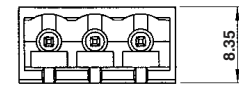
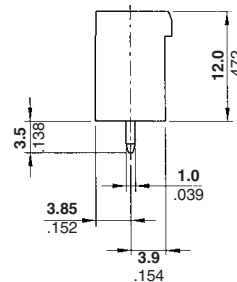
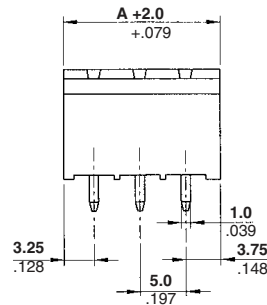
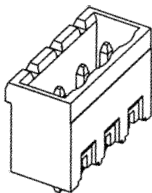

Recommended PC Board Layout

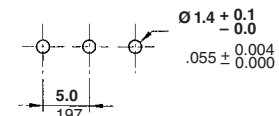

No. of Pos.	Dim. A	Part Numbers				
		Gray	Green	Blue	Black*	
2	10.0 [0.394]	1546211-2	796642-2	796699-2	796643-2	1776146-2
3	15.0 [0.591]	1546211-3	796642-3	796699-3	796643-3	1776146-3
4	20.0 [0.787]	1546211-4	796642-4	796699-4	796643-4	1776146-4
5	25.0 [0.984]	1546211-5	796642-5	796699-5	796643-5	1776146-5
6	30.0 [1.181]	1546211-6	796642-6	796699-6	796643-6	1776146-6
7	35.0 [1.378]	1546211-7	796642-7	796699-7	796643-7	1776146-7
8	40.0 [1.575]	1546211-8	796642-8	796699-8	796643-8	1776146-8
9	45.0 [1.772]	1546211-9	796642-9	796699-9	796643-9	1776146-9
10	50.0 [1.968]	1-1546211-0	1-796642-0	1-796699-0	1-796643-0	1-1776146-0
11	55.0 [2.165]	1-1546211-1	1-796642-1	1-796699-1	1-796643-1	1-1776146-1
12	60.0 [2.362]	1-1546211-2	1-796642-2	1-796699-2	1-796643-2	1-1776146-2
13	65.0 [2.559]	1-1546211-3	1-796642-3	1-796699-3	1-796643-3	—

No. of Positions	Dim. A	Part Numbers				
		Gray	Green	Blue	Black	
14	70.0 [2.756]	1-1546211-4	1-796642-4	1-796699-4	1-796643-4	
15	75.0 [2.953]	1-1546211-5	1-796642-5	1-796699-5	1-796643-5	
16	80.0 [3.150]	1-1546211-6	1-796642-6	1-796699-6	1-796643-6	
17	85.0 [3.346]	1-1546211-7	1-796642-7	1-796699-7	1-796643-7	
18	90.0 [3.543]	1-1546211-8	1-796642-8	1-796699-8	1-796643-8	
19	95.0 [3.740]	1-1546211-9	1-796642-9	1-796699-9	1-796643-9	
20	100.0 [3.937]	2-1546211-0	2-796642-0	2-796699-0	2-796643-0	
21	105.0 [4.134]	2-1546211-1	2-796642-1	2-796699-1	2-796643-1	
22	110.0 [4.331]	2-1546211-2	2-796642-2	2-796699-2	2-796643-2	
23	115.0 [4.528]	2-1546211-3	2-796642-3	2-796699-3	2-796643-3	
24	120.0 [4.724]	2-1546211-4	2-796642-4	2-796699-4	2-796643-4	
25	125.0 [4.921]	2-1546211-5	2-796642-5	2-796699-5	2-796643-5	

Note: BUCHANAN Terminal Block Series B73N4VxxT has been replaced with 796699-xx (blue) and 796643-xx (black).

RDI Terminal Block Series 2EHDV-xx has been replaced with 796642-xx (green) and 796643-xx (black).

*Wave solder process capable to 265°C [509°F] for 10 seconds. Dimensions may vary from what is shown for High Temperature Parts. Please check Customer Drawing.

Note: All part numbers are RoHS Compliant.

Two-Piece Terminal Block Connectors (Continued)

Straight, Open End Stacking Headers, 5.08 mm Centerline Color – See chart. UL Rating – 300 V, 15 A

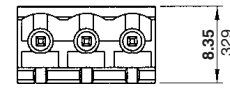
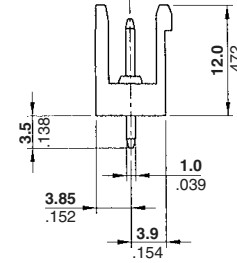
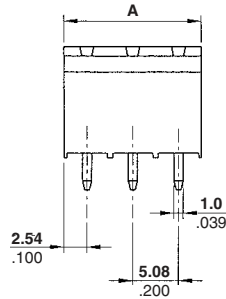
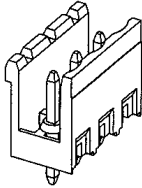

Recommended PC Board Layout

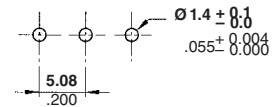

No. of Positions	Dim. A	Part Numbers		
		Green	Gray	Black*
2	10.16 [0.40]	282825-2	1546213-2	1776139-2
3	15.24 [0.60]	282825-3	1546213-3	1776139-3
4	20.32 [0.80]	282825-4	1546213-4	1776139-4
5	25.40 [1.00]	282825-5	1546213-5	1776139-5
6	30.48 [1.20]	282825-6	1546213-6	1776139-6
7	35.56 [1.40]	282825-7	1546213-7	1776139-7
8	40.64 [1.60]	282825-8	1546213-8	1776139-8
9	45.72 [1.80]	282825-9	1546213-9	—
10	50.80 [2.00]	1-282825-0	1-1546213-0	—
11	55.88 [2.20]	1-282825-1	1-1546213-1	—
12	60.96 [2.40]	1-282825-2	1-1546213-2	—
13	66.04 [2.60]	1-282825-3	1-1546213-3	—

No. of Positions	Dim. A	Part Numbers		
		Green	Gray	Black*
14	71.12 [2.80]	1-282825-4	1-1546213-4	—
15	76.20 [3.00]	1-282825-5	1-1546213-5	—
16	81.28 [3.20]	1-282825-6	1-1546213-6	—
17	86.36 [3.40]	1-282825-7	1-1546213-7	—
18	91.44 [3.60]	1-282825-8	1-1546213-8	—
19	96.52 [3.80]	1-282825-9	1-1546213-9	—
20	101.60 [4.00]	2-282825-0	2-1546213-0	—
21	106.68 [4.20]	2-282825-1	2-1546213-1	—
22	111.76 [4.40]	2-282825-2	2-1546213-2	—
23	116.84 [4.60]	2-282825-3	2-1546213-3	—
24	121.92 [4.80]	2-282825-4	2-1546213-4	—
25	127.00 [5.00]	2-282825-5	2-1546213-5	—

*Wave solder process capable to 265°C [509°F] for 10 seconds. Dimensions may vary from what is shown for High Temperature Parts. Please check Customer Drawing.

Straight, Closed End Headers, 5.08 mm Centerline Color – See chart. UL Rating – 300 V, 15 A

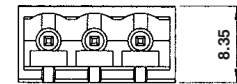
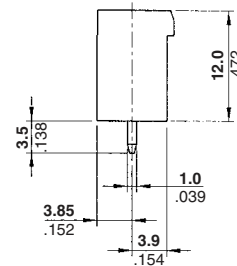
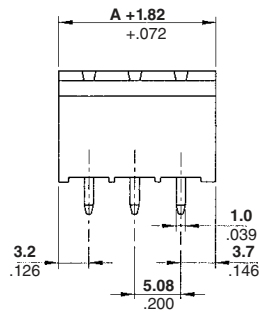
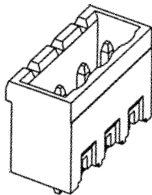

Recommended PC Board Layout

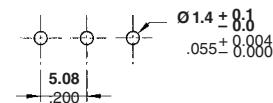

No. of Pos.	Dim. A	Part Numbers			
		Gray	Green	Black	Black*
2	10.16 [0.40]	1546111-2	796636-2	796637-2	1776147-2
3	15.24 [0.60]	1546111-3	796636-3	796637-3	1776147-3
4	20.32 [0.80]	1546111-4	796636-4	796637-4	1776147-4
5	25.40 [1.00]	1546111-5	796636-5	796637-5	1776147-5
6	30.48 [1.20]	1546111-6	796636-6	796637-6	1776147-6
7	35.56 [1.40]	1546111-7	796636-7	796637-7	1776147-7
8	40.64 [1.60]	1546111-8	796636-8	796637-8	1776147-8
9	45.72 [1.80]	1546111-9	796636-9	796637-9	—
10	50.80 [2.00]	1-1546111-0	1-796636-0	1-796637-0	—
11	55.88 [2.20]	1-1546111-1	1-796636-1	1-796637-1	—
12	60.96 [2.40]	1-1546111-2	1-796636-2	1-796637-2	—
13	66.04 [2.60]	1-1546111-3	1-796636-3	1-796637-3	—

No. of Positions	Dim. A	Part Numbers		
		Gray	Green	Black
14	71.12 [2.80]	1-1546111-4	1-796636-4	1-796637-4
15	76.20 [3.00]	1-1546111-5	1-796636-5	1-796637-5
16	81.28 [3.20]	1-1546111-6	1-796636-6	1-796637-6
17	86.36 [3.40]	1-1546111-7	1-796636-7	1-796637-7
18	91.44 [3.60]	1-1546111-8	1-796636-8	1-796637-8
19	96.52 [3.80]	1-1546111-9	1-796636-9	1-796637-9
20	101.60 [4.00]	2-1546111-0	2-796636-0	1-796637-0
21	106.68 [4.20]	2-1546111-1	2-796636-1	2-796637-1
22	111.76 [4.40]	2-1546111-2	2-796636-2	2-796637-2
23	116.84 [4.60]	2-1546111-3	2-796636-3	2-796637-3
24	121.92 [4.80]	2-1546111-4	2-796636-4	2-796637-4
25	127.00 [5.00]	2-1546111-5	2-796636-5	2-796637-5

Note: BUCHANAN Terminal Block Series B2EHDVxx has been superceded/replaced with 796636-xx (green) and 796637-xx (black).

*Wave solder process capable to 265°C [509°F] for 10 seconds. Dimensions may vary from what is shown for High Temperature Parts. Please check Customer Drawing.

Note: All part numbers are RoHS Compliant.

Two-Piece Terminal Block Connectors (Continued)

Straight, Open End Headers, 7.5 mm Centerline
UL Rating – 300 V, 15 A

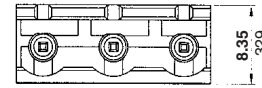
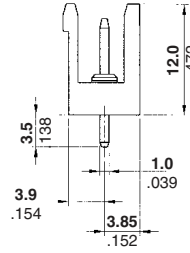
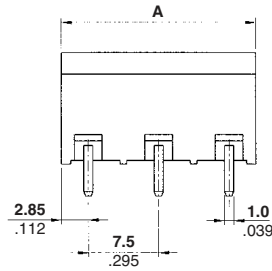
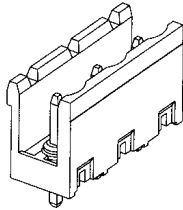

Recommended PC Board Layout

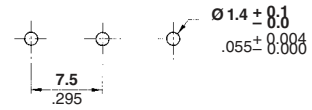

No. of Positions	Dim. A	Part Numbers	
		Green	Black*
2	13.2 [0.520]	282963-2	1776149-2
3	20.7 [0.815]	282963-3	1776149-3
4	28.2 [1.110]	282963-4	1776149-4
5	35.7 [1.406]	282963-5	1776149-5
6	43.2 [1.701]	282963-6	1776149-6
7	50.7 [1.996]	282963-7	1776149-7

No. of Positions	Dim. A	Part Numbers	
		Green	Black*
8	58.2 [2.291]	282963-8	1776149-8
9	65.7 [2.587]	282963-9	1776149-9
10	73.2 [2.882]	1-282963-0	1-1776149-0
11	80.7 [3.177]	1-282963-1	1-1776149-1
12	88.2 [3.472]	1-282963-2	1-1776149-2

*Wave solder process capable to 265°C [509°F] for 10 seconds. Dimensions may vary from what is shown for High Temperature Parts. Please check Customer Drawing.

Straight, Closed End Headers, 7.5 mm Centerline
UL Rating – 300 V, 15 A

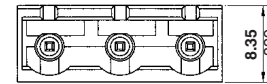
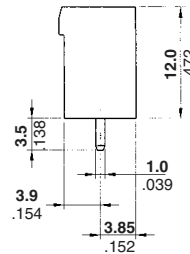
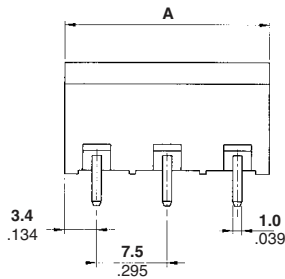
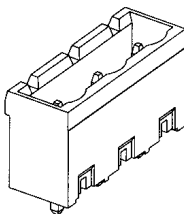

Recommended PC Board Layout

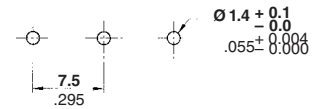

No. of Positions	Dim. A	Part Numbers	
		Green	Black*
2	14.3 [0.563]	282964-2	1776153-2
3	21.8 [0.858]	282964-3	1776153-3
4	29.3 [1.154]	282964-4	1776153-4
5	36.8 [1.449]	282964-5	1776153-5
6	44.3 [1.744]	282964-6	1776153-6
7	51.8 [2.039]	282964-7	1776153-7

No. of Positions	Dim. A	Part Numbers	
		Green	Black*
8	59.3 [2.335]	282964-8	1776153-8
9	66.8 [2.630]	282964-9	1776153-9
10	74.3 [2.925]	1-282964-0	1-1776153-0
11	81.8 [3.220]	1-282964-1	1-1776153-1
12	89.3 [3.516]	1-282964-2	1-1776153-2

*Wave solder process capable to 265°C [509°F] for 10 seconds. Dimensions may vary from what is shown for High Temperature Parts. Please check Customer Drawing.



Note: All part numbers are RoHS Compliant.

Two-Piece Terminal Block Connectors (Continued)

Straight, Open End Headers, 7.62 mm Centerline
UL Rating – 300 V, 15 A

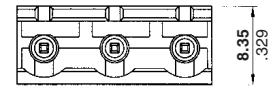
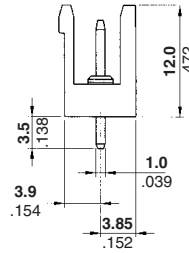
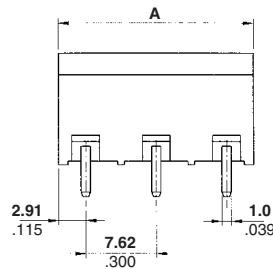
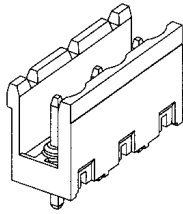

Recommended PC Board Layout

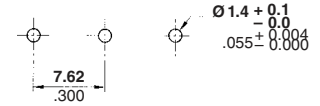

No. of Positions	Dim. A	Part Numbers	
		Green	Black*
2	13.44 [0.529]	282967-2	1776150-2
3	21.06 [0.829]	282967-3	1776150-3
4	28.68 [1.129]	282967-4	1776150-4
5	36.30 [1.429]	282967-5	1776150-5
6	43.92 [1.729]	282967-6	1776150-6
7	51.54 [2.029]	282967-7	1776150-7

No. of Positions	Dim. A	Part Numbers	
		Green	Black*
8	59.16 [2.329]	282967-8	1776150-8
9	66.78 [2.629]	282967-9	1776150-9
10	74.40 [2.929]	1-282967-0	1-1776150-0
11	82.02 [3.229]	1-282967-1	1-1776150-1
12	89.64 [3.529]	1-282967-2	1-1776150-2

*Wave solder process capable to 265°C [509°F] for 10 seconds. Dimensions may vary from what is shown for High Temperature Parts. Please check Customer Drawing.

Straight, Closed End Headers, 7.62 mm Centerline
UL Rating – 300 V, 15 A

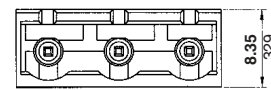
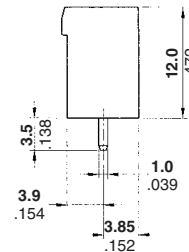
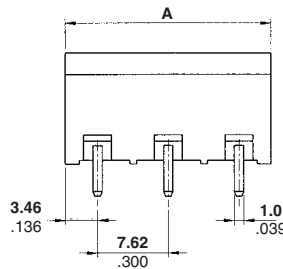
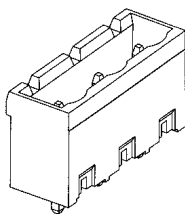

Recommended PC Board Layout

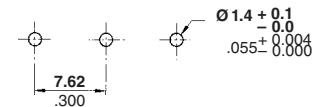

No. of Positions	Dim. A	Part Numbers	
		Green	Black*
2	14.54 [0.572]	796980-2	1776154-2
3	22.16 [0.872]	796980-3	1776154-3
4	29.78 [1.172]	796980-4	1776154-4
5	37.40 [1.472]	796980-5	1776154-5
6	45.02 [1.772]	796980-6	1776154-6
7	52.64 [2.072]	796980-7	1776154-7

No. of Positions	Dim. A	Part Numbers	
		Green	Black*
8	60.26 [2.372]	796980-8	1776154-8
9	67.88 [2.672]	796980-9	1776154-9
10	75.50 [2.972]	1-796980-0	1-1776154-0
11	83.12 [3.272]	1-796980-1	1-1776154-1
12	90.74 [3.572]	1-796980-2	1-1776154-2

*Wave solder process capable to 265°C [509°F] for 10 seconds. Dimensions may vary from what is shown for High Temperature Parts. Please check Customer Drawing.

Note: All part numbers are RoHS Compliant.

Two-Piece Terminal Block Connectors (Continued)

Straight, Open End Headers, 10.0 mm Centerline
UL Rating – 600 V, 24 A

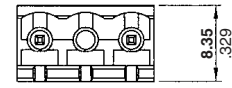
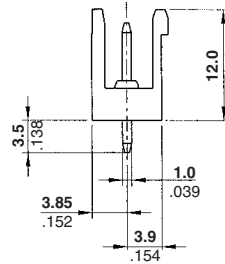
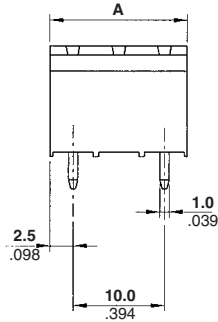
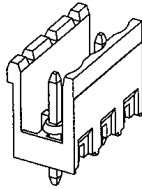

Recommended PC Board Layout

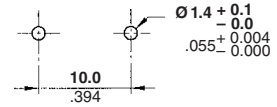

No. of Positions	Dim. A	Part Numbers	
		Green	Black*
2	15.0 [0.591]	282827-2	1776156-2
3	25.0 [0.984]	282827-3	1776156-3
4	35.0 [1.378]	282827-4	1776156-4
5	45.0 [1.772]	282827-5	—
6	55.0 [2.165]	282827-6	—
7	65.0 [2.559]	282827-7	—

No. of Positions	Dim. A	Part Numbers	
		Green	Black*
8	75.0 [2.953]	282827-8	—
9	85.0 [3.346]	282827-9	—
10	95.0 [3.740]	1-282827-0	—
11	105.0 [4.134]	1-282827-1	—
12	115.0 [4.528]	1-282827-2	—
13	125.0 [4.921]	1-282827-3	—

*Wave solder process capable to 265°C [509°F] for 10 seconds. Dimensions may vary from what is shown for High Temperature Parts. Please check Customer Drawing.

Straight, Closed End Headers, 10.0 mm Centerline
UL Rating – 600 V, 24 A

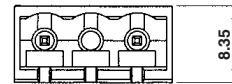
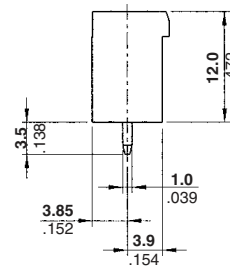
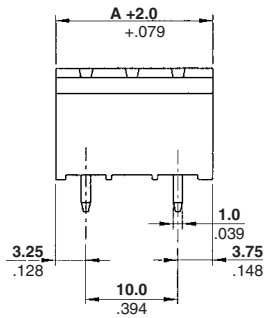
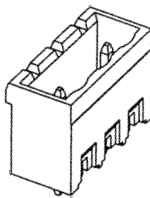

Recommended PC Board Layout

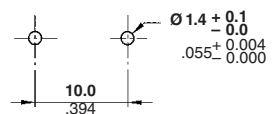

No. of Positions	Dim. A	Part Numbers	
		Green	Black*
2	15.0 [0.591]	282826-2	1776160-2
3	25.0 [0.984]	282826-3	1776160-3
4	35.0 [1.378]	282826-4	1776160-4
5	45.0 [1.772]	282826-5	—
6	55.0 [2.165]	282826-6	—
7	65.0 [2.559]	282826-7	—

No. of Positions	Dim. A	Part Numbers	
		Green	Black*
8	75.0 [2.953]	282826-8	—
9	85.0 [3.346]	282826-9	—
10	95.0 [3.740]	1-282826-0	—
11	105.0 [4.134]	1-282826-1	—
12	115.0 [4.528]	1-282826-2	—
13	125.0 [4.921]	1-282826-3	—

*Wave solder process capable to 265°C [509°F] for 10 seconds. Dimensions may vary from what is shown for High Temperature Parts. Please check Customer Drawing.

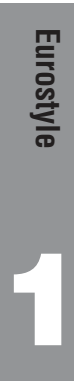

Note: All part numbers are RoHS Compliant.

Two-Piece Terminal Block Connectors (Continued)

Straight, Open End Headers, 10.16 mm Centerline UL Rating – 600 V, 15 A

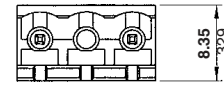
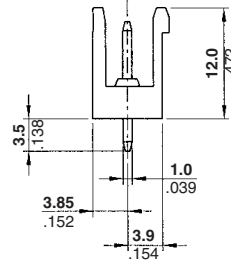
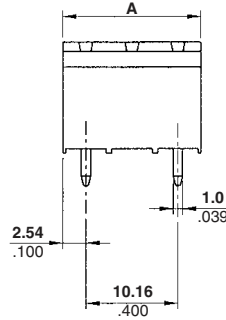
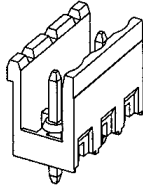

Recommended PC Board Layout

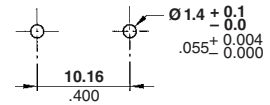

No. of Positions	Dim. A	Part Numbers	
		Green	Black*
2	15.24 [0.60]	282828-2	1776157-2
3	25.40 [1.00]	282828-3	1776157-3
4	35.56 [1.40]	282828-4	1776157-4

*Wave solder process capable to 265°C [509°F] for 10 seconds
Dimensions may vary from what is shown for High Temperature Parts.
Please check Customer Drawing.

Straight, Closed End Headers, 10.16 mm Centerline UL Rating – 600 V, 15 A

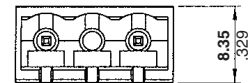
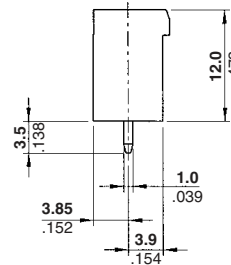
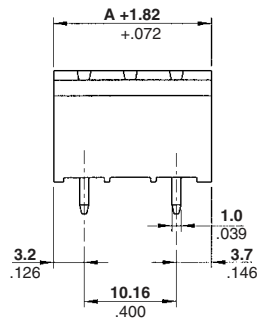
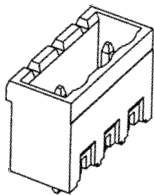

Recommended PC Board Layout

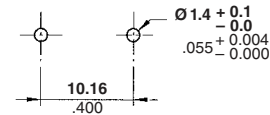

No. of Positions	Dim. A	Part Numbers	
		Green	Black*
2	15.24 [0.60]	282828-2	1776161-2
3	25.40 [1.00]	282828-3	1776161-3
4	35.56 [1.40]	282828-4	1776161-4
5	45.72 [1.80]	282828-5	—
6	55.88 [2.20]	282828-6	—
7	66.04 [2.60]	282828-7	—

No. of Positions	Dim. A	Part Numbers	
		Green	Black*
8	76.20 [3.00]	282828-8	—
9	86.36 [3.40]	282828-9	—
10	96.52 [3.80]	1-282828-0	—
11	106.68 [4.20]	1-282828-1	—
12	116.84 [4.60]	1-282828-2	—
13	127.00 [5.00]	1-282828-3	—

*Wave solder process capable to 265°C [509°F] for 10 seconds. Dimensions may vary from what is shown for High Temperature Parts. Please check Customer Drawing.

Note: All part numbers are RoHS Compliant.

Two-Piece Terminal Block Connectors (Continued)

Straight, Open End Stacking Headers w/Interlock, 5.0 mm Centerline
UL Rating – 300 V, 15 A

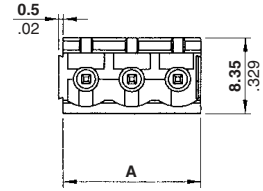
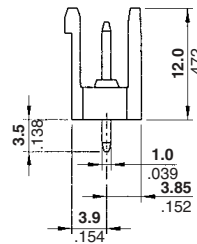
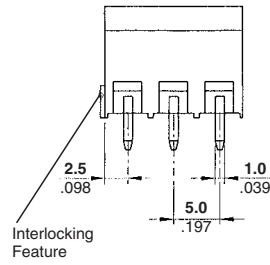
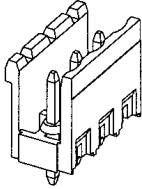

Recommended PC Board Layout

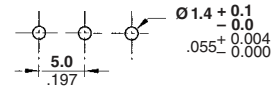

No. of Positions	Dim. A	Part Numbers	
		Green	Black*
2	10.0 [.394]	282821-2	1776142-2
3	15.0 [.591]	282821-3	1776142-3
4	20.0 [.787]	282821-4	1776142-4

*Wave solder process capable to 265°C [509°F] for 10 seconds
Dimensions may vary from what is shown for High Temperature Parts.
Please check Customer Drawing.

Straight, Open End Stacking Headers w/Interlock, 5.08 mm Centerline
UL Rating – 300 V, 15 A

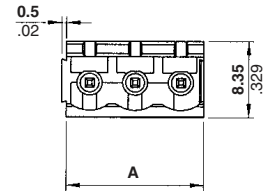
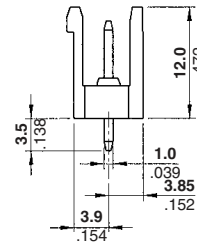
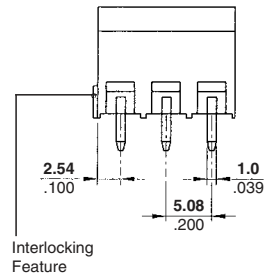
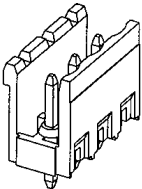

Recommended PC Board Layout

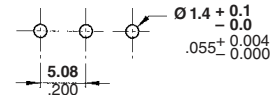

No. of Positions	Dim. A	Part Numbers	
		Green	Black*
2	10.16 [.400]	282824-2	1776143-2
3	15.24 [.600]	282824-3	1776143-3
4	20.32 [.800]	282824-4	1776143-4

*Wave solder process capable to 265°C [509°F] for 10 seconds
Dimensions may vary from what is shown for High Temperature Parts.
Please check Customer Drawing.

Note: All part numbers are RoHS Compliant.

Two-Piece Terminal Block Connectors (Continued)

Right-Angle, Closed End Headers, 3.5 mm Centerline Color – See chart. UL Rating – 300 V, 11 A

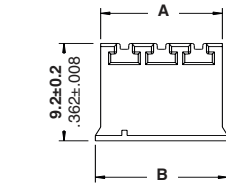
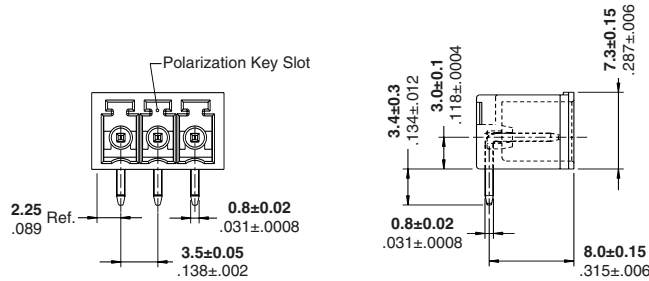
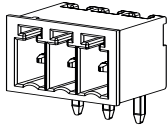

Recommended PC Board Layout

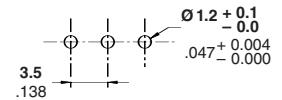

Number of Positions	Dimensions		Part Numbers		
	A	B	Green	Blue	Black*
2	8.0 [0.315]	9.0 [0.354]	284512-2	796695-2	1776134-2
3	11.5 [0.453]	12.5 [0.492]	284512-3	796695-3	1776134-3
4	15.0 [0.590]	16.0 [0.630]	284512-4	796695-4	1776134-4
5	18.5 [0.728]	19.5 [0.768]	284512-5	796695-5	1776134-5
6	22.0 [0.866]	23.0 [0.906]	284512-6	796695-6	1776134-6
7	25.5 [1.004]	26.5 [1.043]	284512-7	796695-7	1776134-7
8	29.0 [1.142]	30.0 [1.181]	284512-8	796695-8	1776134-8
9	32.5 [1.280]	33.5 [1.319]	284512-9	796695-9	—
10	36.0 [1.417]	37.0 [1.457]	1-284512-0	1-796695-0	—
11	39.5 [1.555]	40.5 [1.594]	1-284512-1	1-796695-1	—
12	43.0 [1.693]	44.0 [1.732]	1-284512-2	1-796695-2	—
13	46.5 [1.831]	47.5 [1.870]	1-284512-3	1-796695-3	—

Number of Positions	Dimensions		Part Numbers		
	A	B	Green	Blue	Black*
14	50.0 [1.968]	51.0 [2.008]	1-284512-4	1-796695-4	—
15	53.5 [2.106]	54.5 [2.146]	1-284512-5	1-796695-5	—
16	57.0 [2.244]	58.0 [2.283]	1-284512-6	1-796695-6	—
17	60.5 [2.382]	61.5 [2.421]	1-284512-7	1-796695-7	—
18	64.0 [2.520]	65.0 [2.559]	1-284512-8	1-796695-8	—
19	67.5 [2.657]	68.5 [2.697]	1-284512-9	1-796695-9	—
20	71.0 [2.795]	72.0 [2.835]	2-284512-0	2-796695-0	—
21	74.5 [2.933]	75.5 [2.972]	2-284512-1	2-796695-1	—
22	78.0 [3.071]	79.0 [3.110]	2-284512-2	2-796695-2	—
23	81.5 [3.209]	82.5 [3.248]	2-284512-3	2-796695-3	—
24	85.0 [3.346]	86.0 [3.386]	2-284512-4	2-796695-4	—
25	88.5 [3.484]	89.5 [3.524]	2-284512-5	2-796695-5	—

Note: BUCHANAN Terminal Block Series B73N3HxxT has been replaced with Part Number 796695-xx (blue).

*Wave solder process capable to 265°C [509°F] for 10 seconds. Dimensions may vary from what is shown for High Temperature Parts. Please check Customer Drawing.

Right-Angle, Closed End Headers, 3.81 mm Centerline UL Rating – 300 V, 11 A

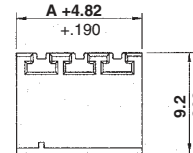
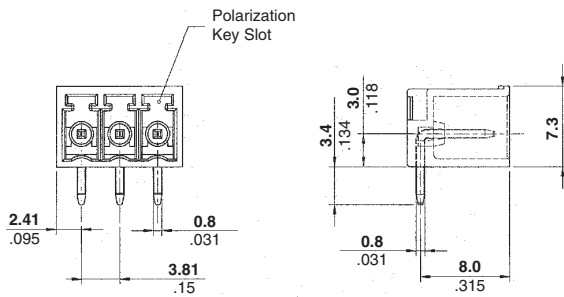
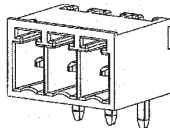

Recommended PC Board Layout

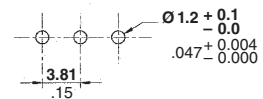

No. of Positions	Dim. A	Part Numbers	
		Green	Black*
2	3.81 [0.15]	284513-2	1776135-2
3	7.62 [0.30]	284513-3	1776135-3
4	11.43 [0.45]	284513-4	1776135-4
5	15.24 [0.60]	284513-5	1776135-5
6	19.05 [0.75]	284513-6	1776135-6
7	22.86 [0.90]	284513-7	1776135-7
8	26.67 [1.05]	284513-8	1776135-8
9	30.48 [1.20]	284513-9	1776135-9
10	34.29 [1.35]	1-284513-0	1-1776135-0
11	38.10 [1.50]	1-284513-1	1-1776135-1
12	41.91 [1.65]	1-284513-2	1-1776135-2
13	45.72 [1.80]	1-284513-3	—

No. of Positions	Dim. A	Part Numbers	
		Green	Black*
14	49.53 [1.95]	1-284513-4	—
15	53.34 [2.10]	1-284513-5	—
16	57.15 [2.25]	1-284513-6	—
17	60.96 [2.40]	1-284513-7	—
18	64.77 [2.55]	1-284513-8	—
19	68.58 [2.70]	1-284513-9	—
20	72.39 [2.85]	2-284513-0	—
21	76.20 [3.00]	2-284513-1	—
22	80.01 [3.15]	2-284513-2	—
23	83.82 [3.30]	2-284513-3	—
24	87.63 [3.45]	2-284513-4	—
25	91.44 [3.60]	2-284513-5	—

*Wave solder process capable to 265°C [509°F] for 10 seconds. Dimensions may vary from what is shown for High Temperature Parts. Please check Customer Drawing.

Note: All part numbers are RoHS Compliant.

Two-Piece Terminal Block Connectors (Continued)

**Right-Angle,
Open End Stacking Headers,
5.0 mm Centerline
Color – See chart.**

UL Rating – 300 V, 15 A

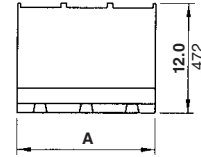
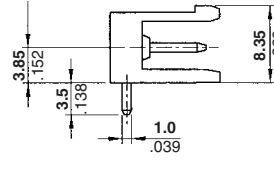
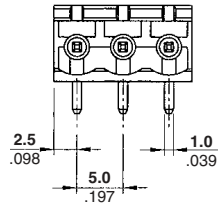
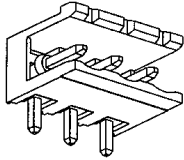

Recommended PC Board Layout

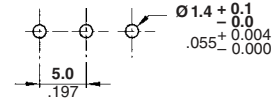

No. of Pos.	Dim. A	Part Numbers				
		Gray	Green	Blue	Black	Black*
2	10.0 [0.394]	1546210-2	282812-2	796698-2	1546179-2	1776140-2
3	15.0 [0.591]	1546210-3	282812-3	796698-3	1546179-3	1776140-3
4	20.0 [0.787]	1546210-4	282812-4	796698-4	1546179-4	1776140-4
5	25.0 [0.984]	1546210-5	282812-5	796698-5	1546179-5	1776140-5
6	30.0 [1.181]	1546210-6	282812-6	796698-6	1546179-6	1776140-6
7	35.0 [1.378]	1546210-7	282812-7	796698-7	1546179-7	1776140-7
8	40.0 [1.575]	1546210-8	282812-8	796698-8	1546179-8	1776140-8
9	45.0 [1.772]	1546210-9	282812-9	796698-9	1546179-9	1776140-9
10	50.0 [1.968]	1-1546210-0	1-282812-0	1-796698-0	1-1546179-0	1-1776140-0
11	55.0 [2.165]	1-1546210-1	1-282812-1	1-796698-1	1-1546179-1	1-1776140-1
12	60.0 [2.362]	1-1546210-2	1-282812-2	1-796698-2	1-1546179-2	1-1776140-2
13	65.0 [2.559]	1-1546210-3	1-282812-3	1-796698-3	1-1546179-3	—
14	70.0 [2.756]	1-1546210-4	1-282812-4	1-796698-4	1-1546179-4	—
15	75.0 [2.953]	1-1546210-5	1-282812-5	1-796698-5	1-1546179-5	—
16	80.0 [3.150]	1-1546210-6	1-282812-6	1-796698-6	1-1546179-6	—
17	85.0 [3.346]	1-1546210-7	1-282812-7	1-796698-7	1-1546179-7	—
18	90.0 [3.543]	1-1546210-8	1-282812-8	1-796698-8	1-1546179-8	—
19	95.0 [3.740]	1-1546210-9	1-282812-9	1-796698-9	1-1546179-9	—
20	100.0 [3.937]	2-1546210-0	2-282812-0	2-796698-0	2-1546179-0	—
21	105.0 [4.134]	2-1546210-1	2-282812-1	2-796698-1	2-1546179-1	—
22	110.0 [4.331]	2-1546210-2	2-282812-2	2-796698-2	2-1546179-2	—
23	115.0 [4.528]	2-1546210-3	2-282812-3	2-796698-3	2-1546179-3	—
24	120.0 [4.724]	2-1546210-4	2-282812-4	2-796698-4	2-1546179-4	—
25	125.0 [4.921]	2-1546210-5	2-282812-5	2-796698-5	2-1546179-5	—

Note: BUCHANAN Terminal Block Series B72N4HxxT has been replaced with 796698-xx (blue).
*Wave solder process capable to 265°C [509°F] for 10 seconds. Dimensions may vary from what is shown for High Temperature Parts. Please check Customer Drawing.

Note: All part numbers are RoHS Compliant.

Two-Piece Terminal Block Connectors (Continued)

**Right-Angle,
Closed End Headers,
5.0 mm Centerline
Color – See chart.
UL Rating – 300 V, 15 A**

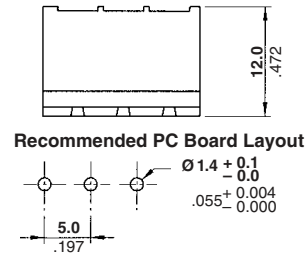
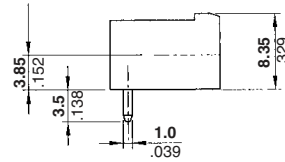
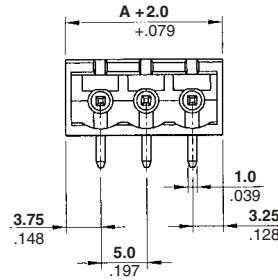
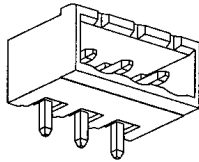

No. of Pos.	Dim. A	Part Numbers				
		Gray	Green	Blue	Black	Black*
2	10.0 [0.394]	1546209-2	796644-2	796700-2	796645-2	1776148-2
3	15.0 [0.591]	1546209-3	796644-3	796700-3	796645-3	1776148-3
4	20.0 [0.787]	1546209-4	796644-4	796700-4	796645-4	1776148-4
5	25.0 [0.984]	1546209-5	796644-5	796700-5	796645-5	1776148-5
6	30.0 [1.181]	1546209-6	796644-6	796700-6	796645-6	1776148-6
7	35.0 [1.378]	1546209-7	796644-7	796700-7	796645-7	1776148-7
8	40.0 [1.575]	1546209-8	796644-8	796700-8	796645-8	1776148-8
9	45.0 [1.772]	1546209-9	796644-9	796700-9	796645-9	—
10	50.0 [1.968]	1-1546209-0	1-796644-0	1-796700-0	1-796645-0	—
11	55.0 [2.165]	1-1546209-1	1-796644-1	1-796700-1	1-796645-1	—
12	60.0 [2.362]	1-1546209-2	1-796644-2	1-796700-2	1-796645-2	—
13	65.0 [2.559]	1-1546209-3	1-796644-3	1-796700-3	1-796645-3	—
14	70.0 [2.756]	1-1546209-4	1-796644-4	1-796700-4	1-796645-4	—
15	75.0 [2.953]	1-1546209-5	1-796644-5	1-796700-5	1-796645-5	—
16	80.0 [3.150]	1-1546209-6	1-796644-6	1-796700-6	1-796645-6	—
17	85.0 [3.346]	1-1546209-7	1-796644-7	1-796700-7	1-796645-7	—
18	90.0 [3.543]	1-1546209-8	1-796644-8	1-796700-8	1-796645-8	—
19	95.0 [3.740]	1-1546209-9	1-796644-9	1-796700-9	1-796645-9	—
20	100.0 [3.937]	2-1546209-0	2-796644-0	2-796700-0	2-796645-0	—
21	105.0 [4.134]	2-1546209-1	2-796644-1	2-796700-1	2-796645-1	—
22	110.0 [4.331]	2-1546209-2	2-796644-2	2-796700-2	2-796645-2	—
23	115.0 [4.528]	2-1546209-3	2-796644-3	2-796700-3	2-796645-3	—
24	120.0 [4.724]	2-1546209-4	2-796644-4	2-796700-4	2-796645-4	—
25	125.0 [4.921]	2-1546209-5	2-796644-5	2-796700-5	2-796645-5	—

Note: RDI Terminal Block Series 2EHDR-xx has been replaced with 796644-xx (green) and 796645-xx (black).
BUCHANAN Terminal Block Series B73N4HxxT has been replaced with 796700-xx (blue) and 796645-xx (black).

*Wave solder process capable to 265°C [509°F] for 10 seconds. Dimensions may vary from what is shown for High Temperature Parts. Please check Customer Drawing.

Note: All part numbers are RoHS Compliant.

Two-Piece Terminal Block Connectors (Continued)

Right-Angle, Open End Stacking Headers, 5.08 mm Centerline Color – See chart.

UL Rating – 300 V, 15 A

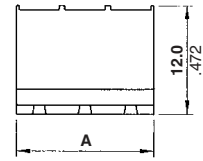
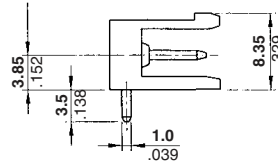
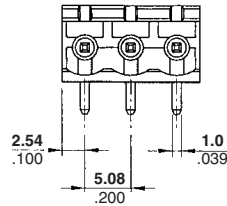
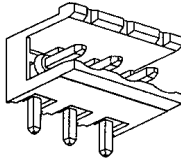

Recommended PC Board Layout

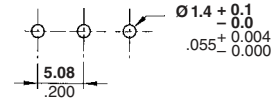

No. of Positions	Dim. A	Part Numbers		
		Green	Gray	Black*
2	10.16 [0.40]	282815-2	1546110-2	1776141-2
3	15.24 [0.60]	282815-3	1546110-3	1776141-3
4	20.32 [0.80]	282815-4	1546110-4	1776141-4
5	25.40 [1.00]	282815-5	1546110-5	1776141-5
6	30.48 [1.20]	282815-6	1546110-6	1776141-6
7	35.56 [1.40]	282815-7	1546110-7	1776141-7
8	40.64 [1.60]	282815-8	1546110-8	1776141-8
9	45.72 [1.80]	282815-9	1546110-9	—
10	50.80 [2.00]	1-282815-0	1-1546110-0	—
11	55.88 [2.20]	1-282815-1	1-1546110-1	—
12	60.96 [2.40]	1-282815-2	1-1546110-2	—
13	66.04 [2.60]	1-282815-3	1-1546110-3	—

No. of Positions	Dim. A	Part Numbers		
		Green	Gray	Black*
14	71.12 [2.80]	1-282815-4	1-1546110-4	—
15	76.20 [3.00]	1-282815-5	1-1546110-5	—
16	81.28 [3.20]	1-282815-6	1-1546110-6	—
17	86.36 [3.40]	1-282815-7	1-1546110-7	—
18	91.44 [3.60]	1-282815-8	1-1546110-8	—
19	96.52 [3.80]	1-282815-9	1-1546110-9	—
20	101.60 [4.00]	2-282815-0	2-1546110-0	—
21	106.68 [4.20]	2-282815-1	2-1546110-1	—
22	111.76 [4.40]	2-282815-2	2-1546110-2	—
23	116.84 [4.60]	2-282815-3	2-1546110-3	—
24	121.92 [4.80]	2-282815-4	2-1546110-4	—
25	127.00 [5.00]	2-282815-5	2-1546110-5	—

*Wave solder process capable to 265°C [509°F] for 10 seconds. Dimensions may vary from what is shown for High Temperature Parts. Please check Customer Drawing.

Right-Angle, Closed End Headers, 5.08 mm Centerline Color – See chart.

UL Rating – 300 V, 15 A

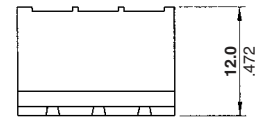
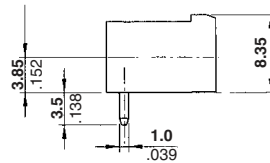
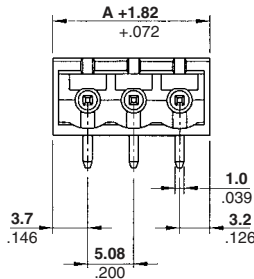
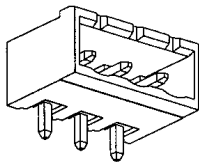

Recommended PC Board Layout

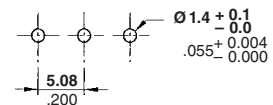

No. of Pos.	Dim. A	Part Numbers			
		Gray	Green	Black	Black*
2	10.16 [0.40]	1546109-2	796638-2	796639-2	1776038-2
3	15.24 [0.60]	1546109-3	796638-3	796639-3	1776038-3
4	20.32 [0.80]	1546109-4	796638-4	796639-4	1776038-4
5	25.40 [1.00]	1546109-5	796638-5	796639-5	1776038-5
6	30.48 [1.20]	1546109-6	796638-6	796639-6	1776038-6
7	35.56 [1.40]	1546109-7	796638-7	796639-7	1776038-7
8	40.64 [1.60]	1546109-8	796638-8	796639-8	1776038-8
9	45.72 [1.80]	1546109-9	796638-9	796639-9	—
10	50.80 [2.00]	1-1546109-0	1-796638-0	1-796639-0	—
11	55.88 [2.20]	1-1546109-1	1-796638-1	1-796639-1	—
12	60.96 [2.40]	1-1546109-2	1-796638-2	1-796639-2	—
13	66.04 [2.60]	1-1546109-3	1-796638-3	1-796639-3	—

No. of Positions	Dim. A	Part Numbers		
		Gray	Green	Black
14	71.12 [2.80]	1-1546109-4	1-796638-4	1-796639-4
15	76.20 [3.00]	1-1546109-5	1-796638-5	1-796639-5
16	81.28 [3.20]	1-1546109-6	1-796638-6	1-796639-6
17	86.36 [3.40]	1-1546109-7	1-796638-7	1-796639-7
18	91.44 [3.60]	1-1546109-8	1-796638-8	1-796639-8
19	96.52 [3.80]	1-1546109-9	1-796638-9	1-796639-9
20	101.60 [4.00]	2-1546109-0	2-796638-0	2-796639-0
21	106.68 [4.20]	2-1546109-1	2-796638-1	2-796639-1
22	111.76 [4.40]	2-1546109-2	2-796638-2	2-796639-2
23	116.84 [4.60]	2-1546109-3	2-796638-3	2-796639-3
24	121.92 [4.80]	2-1546109-4	2-796638-4	2-796639-4
25	127.00 [5.00]	2-1546109-5	2-796638-5	2-796639-5

Note: RDI Terminal Block Series 2EHDR-xx has been superceded/replaced with 796638-xx (green) and 796639-xx (black).

*Wave solder process capable to 265°C [509°F] for 10 seconds. Dimensions may vary from what is shown for High Temperature Parts. Please check Customer Drawing.



Note: All part numbers are RoHS Compliant.

Two-Piece Terminal Block Connectors (Continued)

Right-Angle, Open End Headers, 7.5 mm Centerline Color – Green UL Rating – 300 V, 15 A

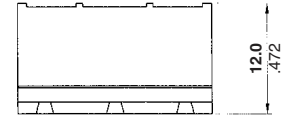
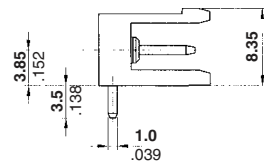
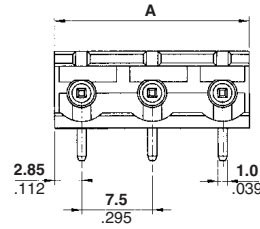
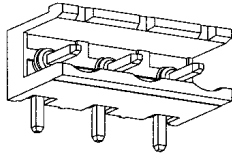

Recommended PC Board Layout

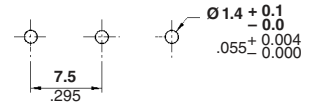

No. of Positions	Dim. A	Part Numbers
2	13.2 [0.520]	282961-2
3	20.7 [0.815]	282961-3
4	28.2 [1.110]	282961-4
5	35.7 [1.406]	282961-5
6	43.2 [1.701]	282961-6
7	50.7 [1.996]	282961-7

No. of Positions	Dim. A	Part Numbers
8	58.2 [2.291]	282961-8
9	65.7 [2.587]	282961-9
10	73.2 [2.882]	1-282961-0
11	80.7 [3.177]	1-282961-1
12	88.2 [3.472]	1-282961-2

Right-Angle, Closed End Headers, 7.5 mm Centerline Color – Green UL Rating – 300 V, 15 A

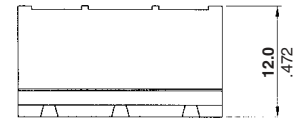
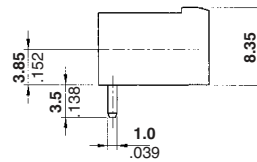
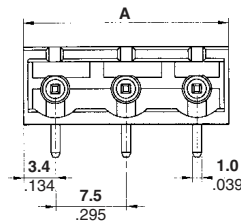
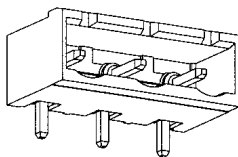

Recommended PC Board Layout

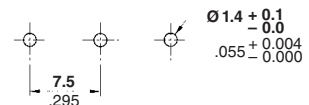

No. of Positions	Dim. A	Part Numbers
2	14.3 [0.563]	282962-2
3	21.8 [0.858]	282962-3
4	29.3 [1.154]	282962-4
5	36.8 [1.449]	282962-5
6	44.3 [1.744]	282962-6
7	51.8 [2.039]	282962-7

No. of Positions	Dim. A	Part Numbers
8	59.3 [2.335]	282962-8
9	66.8 [2.630]	282962-9
10	74.3 [2.925]	1-282962-0
11	81.8 [3.220]	1-282962-1
12	89.3 [3.516]	1-282962-2

Note: All part numbers are RoHS Compliant.

Two-Piece Terminal Block Connectors (Continued)

Right-Angle, Open End Headers, 7.62 mm Centerline
UL Rating – 300 V, 15 A

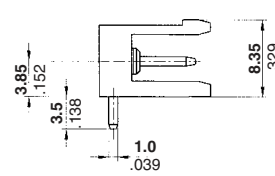
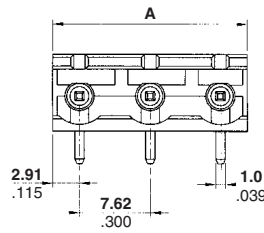
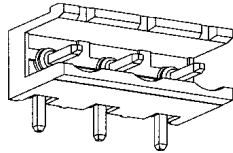

Recommended PC Board Layout

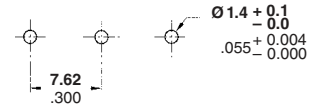

No. of Positions	Dim. A	Part Numbers	
		Green	Black*
2	13.44 [0.529]	282965-2	1776152-2
3	21.06 [0.829]	282965-3	1776152-3
4	28.68 [1.129]	282965-4	—
5	36.30 [1.429]	282965-5	—
6	43.92 [1.729]	282965-6	—
7	51.54 [2.029]	282965-7	—

No. of Positions	Dim. A	Part Numbers	
		Green	Black*
8	59.16 [2.329]	282965-8	—
9	66.78 [2.629]	282965-9	—
10	74.40 [2.929]	1-282965-0	—
11	82.02 [3.229]	1-282965-1	—
12	89.64 [3.529]	1-282965-2	—

*Wave solder process capable to 265°C [509°F] for 10 seconds
Dimensions may vary from what is shown for High Temperature Parts.
Please check Customer Drawing.

Right-Angle, Closed End Headers, 7.62 mm Centerline
UL Rating – 300 V, 15 A

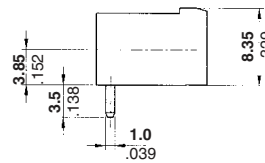
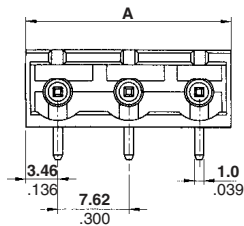
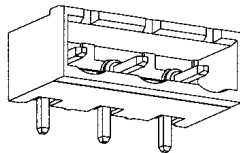

Recommended PC Board Layout

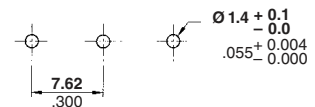

No. of Positions	Dim. A	Part Numbers	
		Green	Black*
2	14.44 [0.568]	282966-2	1776155-2
3	22.06 [0.868]	282966-3	1776155-3
4	29.68 [1.168]	282966-4	1776155-4
5	37.30 [1.468]	282966-5	1776155-5
6	44.92 [1.768]	282966-6	1776155-6
7	52.54 [2.068]	282966-7	1776155-7

No. of Positions	Dim. A	Part Numbers	
		Green	Black*
8	60.16 [2.368]	282966-8	1776155-8
9	67.78 [2.668]	282966-9	1776155-9
10	75.40 [2.968]	1-282966-0	1-1776155-0
11	83.02 [3.268]	1-282966-1	1-1776155-1
12	90.64 [3.568]	1-282966-2	1-1776155-2

*Wave solder process capable to 265°C [509°F] for 10 seconds
Dimensions may vary from what is shown for High Temperature Parts.
Please check Customer Drawing.



Note: All part numbers are RoHS Compliant.

Two-Piece Terminal Block Connectors (Continued)

Right-Angle, Open End Headers, 10.0 mm Centerline
UL Rating – 600 V, 15 A

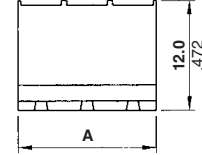
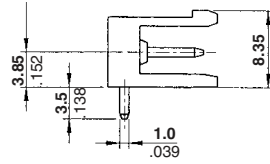
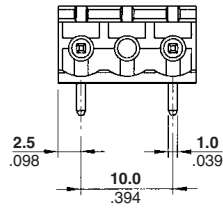
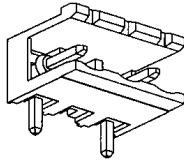

Recommended PC Board Layout

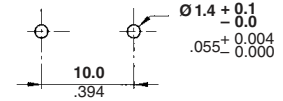

No. of Positions	Dim. A	Part Numbers	
		Green	Black*
2	15.0 [0.591]	282817-2	1776158-2
3	25.0 [0.984]	282817-3	1776158-3
4	35.0 [1.378]	282817-4	1776158-4
5	45.0 [1.772]	282817-5	—
6	55.0 [2.165]	282817-6	—
7	65.0 [2.559]	282817-7	—

No. of Positions	Dim. A	Part Numbers	
		Green	Black*
8	75.0 [2.953]	282817-8	—
9	85.0 [3.346]	282817-9	—
10	95.0 [3.740]	1-282817-0	—
11	105.0 [4.134]	1-282817-1	—
12	115.0 [4.528]	1-282817-2	—
13	125.0 [4.921]	1-282817-3	—

*Wave solder process capable to 265°C [509°F] for 10 seconds. Dimensions may vary from what is shown for High Temperature Parts. Please check Customer Drawing.

Right-Angle, Closed End Headers, 10.0 mm Centerline
UL Rating – 600 V, 15 A

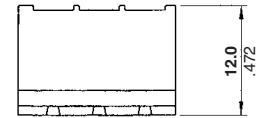
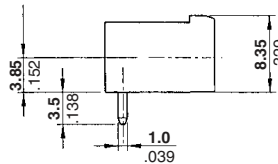
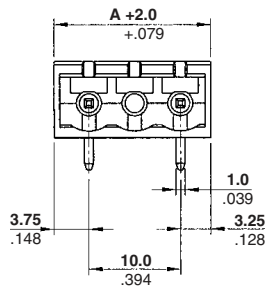
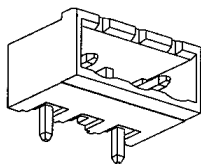

Recommended PC Board Layout

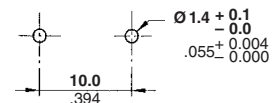

No. of Positions	Dim. A	Part Numbers	
		Green	Black*
2	15.0 [0.591]	282816-2	1776162-2
3	25.0 [0.984]	282816-3	1776162-3
4	35.0 [1.378]	282816-4	1776162-4
5	45.0 [1.772]	282816-5	—
6	55.0 [2.165]	282816-6	—
7	65.0 [2.559]	282816-7	—

No. of Positions	Dim. A	Part Numbers	
		Green	Black*
8	75.0 [2.953]	282816-8	—
9	85.0 [3.346]	282816-9	—
10	95.0 [3.740]	1-282816-0	—
11	105.0 [4.134]	1-282816-1	—
12	115.0 [4.528]	1-282816-2	—
13	125.0 [4.921]	1-282816-3	—

*Wave solder process capable to 265°C [509°F] for 10 seconds. Dimensions may vary from what is shown for High Temperature Parts. Please check Customer Drawing.

Note: All part numbers are RoHS Compliant.

Two-Piece Terminal Block Connectors (Continued)

Right-Angle, Open End Headers, 10.16 mm Centerline
UL Rating – 600 V, 15 A

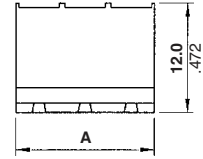
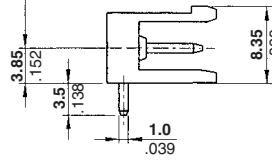
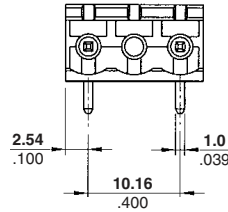
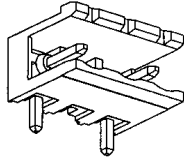

Recommended PC Board Layout

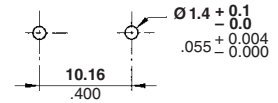

No. of Positions	Dim. A	Part Numbers	
		Green	Black*
2	15.24 [0.60]	282819-2	1776159-2
3	25.40 [1.00]	282819-3	1776159-3
4	35.56 [1.40]	282819-4	1776159-4
5	45.72 [1.80]	282819-5	—
6	55.88 [2.20]	282819-6	—
7	66.04 [2.60]	282819-7	—

No. of Positions	Dim. A	Part Numbers	
		Green	Black*
8	76.20 [3.00]	282819-8	—
9	86.36 [3.40]	282819-9	—
10	96.52 [3.80]	1-282819-0	—
11	106.68 [4.20]	1-282819-1	—
12	116.84 [4.60]	1-282819-2	—
13	127.00 [5.00]	1-282819-3	—

*Wave solder process capable to 265°C [509°F] for 10 seconds. Dimensions may vary from what is shown for High Temperature Parts. Please check Customer Drawing.

Right-Angle, Closed End Headers, 10.16 mm Centerline
UL Rating – 600 V, 15 A

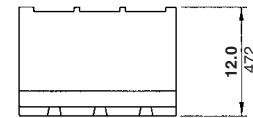
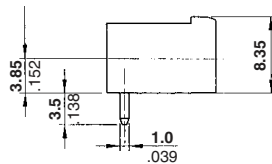
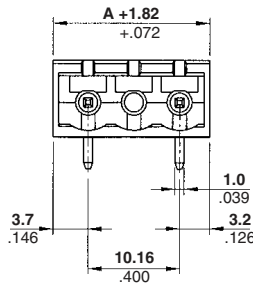
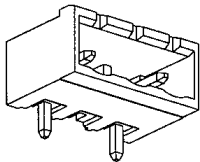

Recommended PC Board Layout

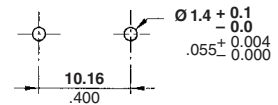

No. of Positions	Dim. A	Part Numbers	
		Green	Black*
2	15.24 [0.60]	282818-2	1776163-2
3	25.40 [1.00]	282818-3	1776163-3
4	35.56 [1.40]	282818-4	1776163-4
5	45.72 [1.80]	282818-5	—
6	55.88 [2.20]	282818-6	—
7	66.04 [2.60]	282818-7	—

No. of Positions	Dim. A	Part Numbers	
		Green	Black*
8	76.20 [3.00]	282818-8	—
9	86.36 [3.40]	282818-9	—
10	96.52 [3.80]	1-282818-0	—
11	106.68 [4.20]	1-282818-1	—
12	116.84 [4.60]	1-282818-2	—
13	127.00 [5.00]	1-282818-3	—

*Wave solder process capable to 265°C [509°F] for 10 seconds. Dimensions may vary from what is shown for High Temperature Parts. Please check Customer Drawing.



Note: All part numbers are RoHS Compliant.

Two-Piece Terminal Block Connectors (Continued)

**Right-Angle,
Open End Stacking Headers
with Interlock,
5.0 mm Centerline
UL Rating – 300 V, 15 A**

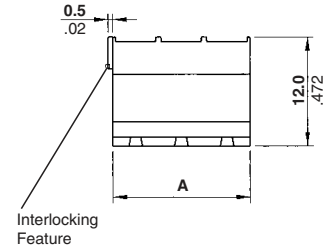
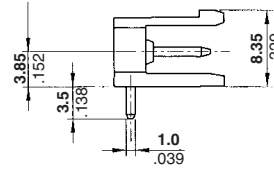
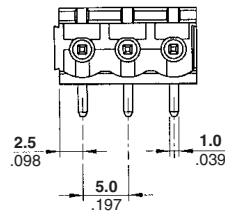
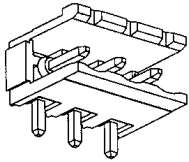

Recommended PC Board Layout

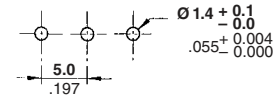

No. of Positions	Dim. A	Part Numbers	
		Green	Black*
2	10.0 [.394]	282811-2	1776144-2
3	15.0 [.591]	282811-3	1776144-3
4	20.0 [.787]	282811-4	1776144-4

*Wave solder process capable to 265°C [509°F] for 10 seconds
Dimensions may vary from what is shown for High Temperature Parts.
Please check Customer Drawing.

**Right-Angle,
Open End Stacking Headers
with Interlock,
5.08 mm Centerline
UL Rating – 300 V, 15 A**

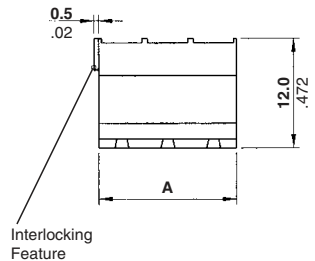
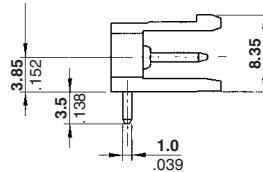
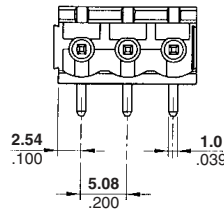
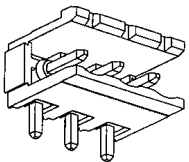

Recommended PC Board Layout

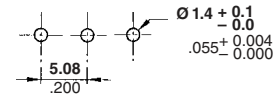

No. of Positions	Dim. A	Part Numbers	
		Green	Black*
2	10.16 [.400]	282814-2	1776145-2
3	15.24 [.600]	282814-3	1776145-3
4	20.32 [.800]	282814-4	1776145-4

*Wave solder process capable to 265°C [509°F] for 10 seconds
Dimensions may vary from what is shown for High Temperature Parts.
Please check Customer Drawing.

Two-Piece Terminal Block Connectors (Continued)

**Right-Angle,
Closed End Headers,
w/Ejectors,
5.08 mm Centerline
Color – Green**
UL Rating – 300 V, 15 A

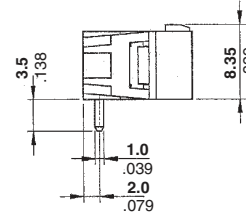
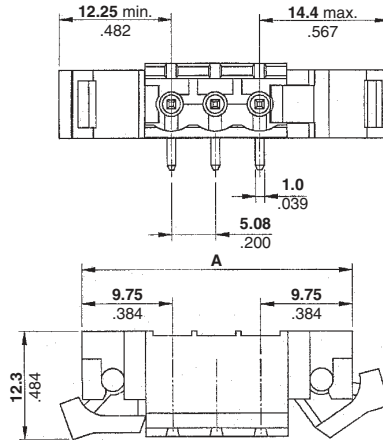
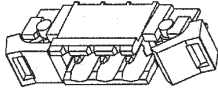

Recommended PC Board Layout

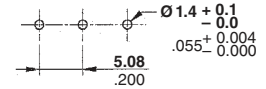

No. of Positions	Dim. A	Part Numbers
2	24.58 [.968]	284008-2
3	29.66 [1.168]	284008-3
4	34.74 [1.368]	284008-4
5	39.82 [1.568]	284008-5
6	44.90 [1.768]	284008-6
7	49.98 [1.968]	284008-7
8	55.06 [2.168]	284008-8
9	60.14 [2.368]	284008-9
10	65.22 [2.568]	1-284008-0
11	70.30 [2.768]	1-284008-1

No. of Positions	Dim. A	Part Numbers
12	75.38 [2.968]	1-284008-2
13	80.46 [3.168]	1-284008-3
14	85.54 [3.368]	1-284008-4
15	90.62 [3.568]	1-284008-5
16	95.70 [3.768]	1-284008-6
17	100.78 [3.968]	1-284008-7
18	105.86 [4.168]	1-284008-8
19	110.94 [4.368]	1-284008-9
20	116.02 [4.568]	2-284008-0
21	121.10 [4.768]	2-284008-1



Note: All part numbers are RoHS Compliant.

Two-Piece Terminal Block Connectors (Continued)

Vertical, Closed End Double-Row Header
5.0 mm Centerline
Color – See chart.
UL Rating – 300 V, 12 A

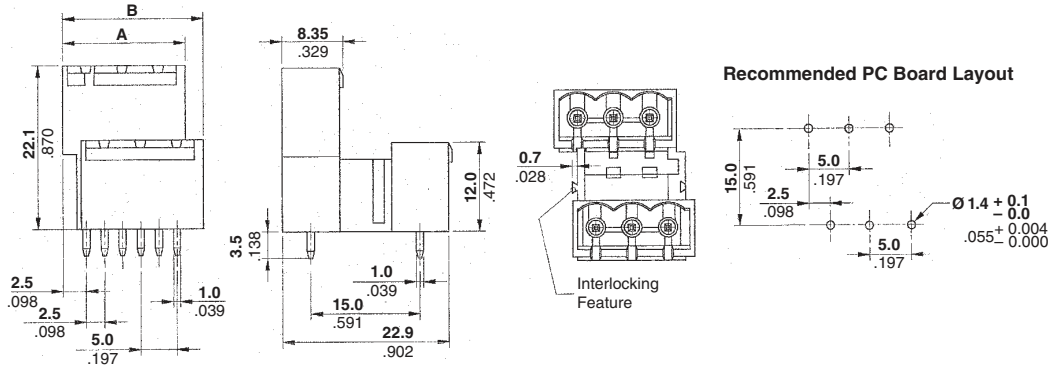
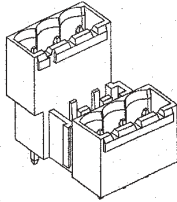

No. of Positions	Dimensions		Part Numbers		
	A	B	Green	Gray	Black*
2	12.0 [0.472]	14.5 [0.571]	284056-2	1546106-2	1776164-2
3	17.0 [0.669]	19.5 [0.768]	284056-3	1546106-3	1776164-3
4	22.0 [0.866]	24.5 [0.965]	284056-4	1546106-4	1776164-4
5	27.0 [1.063]	29.5 [1.161]	284056-5	1546106-5	1776164-5
6	32.0 [1.260]	34.5 [1.358]	284056-6	1546106-6	1776164-6
7	37.0 [1.457]	39.5 [1.555]	284056-7	1546106-7	1776164-7
8	42.0 [1.654]	44.5 [1.752]	284056-8	1546106-8	1776164-8
9	47.0 [1.850]	49.5 [1.949]	284056-9	1546106-9	—
10	52.0 [2.047]	54.5 [2.146]	284056-10	1-1546106-0	—
11	57.0 [2.244]	59.5 [2.343]	284056-11	1-1546106-1	—
12	62.0 [2.441]	64.5 [2.539]	284056-12	1-1546106-2	—
13	67.0 [2.638]	69.5 [2.736]	284056-13	1-1546106-3	—

No. of Positions	Dimensions		Part Numbers		
	A	B	Green	Gray	Black*
14	72.0 [2.835]	74.5 [2.933]	284056-14	1-1546106-4	—
15	77.0 [3.031]	79.5 [3.130]	284056-15	1-1546106-5	—
16	82.0 [3.228]	84.5 [3.327]	284056-16	1-1546106-6	—
17	87.0 [3.425]	89.5 [3.524]	284056-17	1-1546106-7	—
18	92.0 [3.622]	94.5 [3.720]	284056-18	1-1546106-8	—
19	97.0 [3.819]	99.5 [3.917]	284056-19	1-1546106-9	—
20	102.0 [4.016]	104.5 [4.114]	284056-20	2-1546106-0	—
21	107.0 [4.213]	109.5 [4.311]	284056-21	2-1546106-1	—
22	112.0 [4.409]	114.5 [4.508]	284056-22	2-1546106-2	—
23	117.0 [4.606]	119.5 [4.705]	284056-23	2-1546106-3	—
24	122.0 [4.803]	124.5 [4.902]	284056-24	2-1546106-4	—
25	127.0 [5.000]	129.5 [5.098]	284056-25	2-1546106-5	—

*Wave solder process capable to 265°C [509°F] for 10 seconds

Vertical, Closed End Double-Row Header
5.08 mm Centerline
UL Rating – 300 V, 12 A

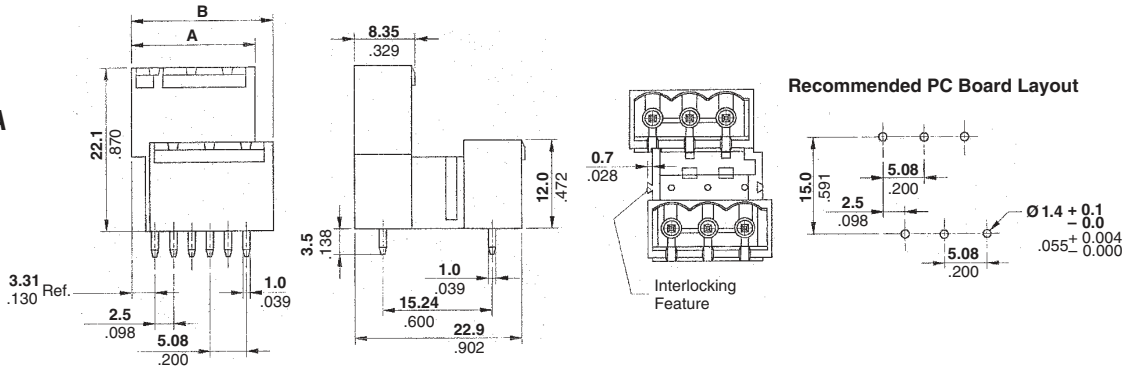
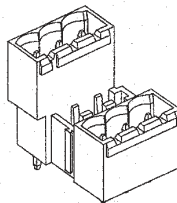

No. of Positions	Dim.		Part Numbers	
	A	B	Green	Black*
2	12.20 [0.48]	14.74 [0.58]	284065-2	1776165-2
3	17.28 [0.68]	19.82 [0.78]	284065-3	1776165-3
4	22.36 [0.88]	24.90 [0.98]	284065-4	1776165-4
5	27.44 [1.08]	29.98 [1.18]	284065-5	1776165-5
6	32.52 [1.28]	35.06 [1.38]	284065-6	1776165-6
7	37.60 [1.48]	40.14 [1.58]	284065-7	1776165-7
8	42.68 [1.68]	45.22 [1.78]	284065-8	1776165-8
9	47.76 [1.88]	50.30 [1.98]	284065-9	—
10	52.84 [2.08]	55.38 [2.18]	1-284065-0	—
11	57.92 [2.28]	60.46 [2.68]	1-284065-1	—
12	63.00 [2.48]	65.54 [2.58]	1-284065-2	—
13	68.08 [2.68]	70.62 [2.78]	1-284065-3	—

No. of Positions	Dim.		Part Numbers	
	A	B	Green	Black*
14	72.0 [2.835]	74.5 [2.933]	1-284065-4	—
15	77.0 [3.031]	79.5 [3.130]	1-284065-5	—
16	82.0 [3.228]	84.5 [3.327]	1-284065-6	—
17	87.0 [3.425]	89.5 [3.524]	1-284065-7	—
18	92.0 [3.622]	94.5 [3.720]	1-284065-8	—
19	97.0 [3.819]	99.5 [3.917]	1-284065-9	—
20	102.0 [4.016]	104.5 [4.114]	2-284065-0	—
21	107.0 [4.213]	109.5 [4.311]	2-284065-1	—
22	112.0 [4.409]	114.5 [4.508]	2-284065-2	—
23	117.0 [4.606]	119.5 [4.705]	2-284065-3	—
24	122.0 [4.803]	124.5 [4.902]	2-284065-4	—
25	127.0 [5.000]	129.5 [5.098]	2-284065-5	—

*Wave solder process capable to 265°C [509°F] for 10 seconds

Note: All part numbers are RoHS Compliant.

Two-Piece Terminal Block Connectors (Continued)

**Vertical, Closed End
Double-Row Header
10.0 mm Centerline
Color – Black
UL Rating – 600 V, 12 A**

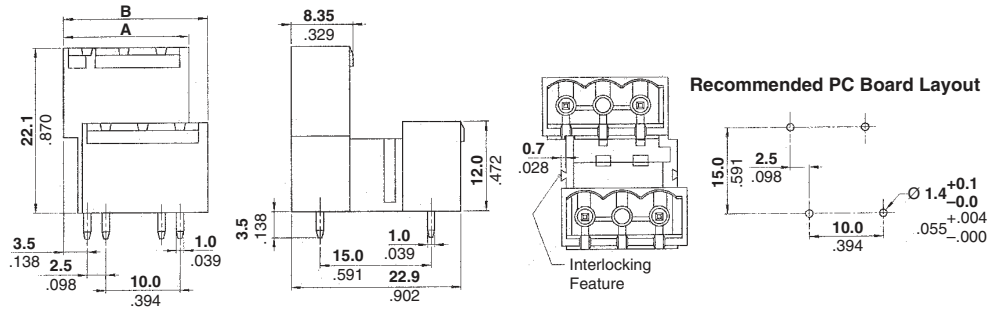
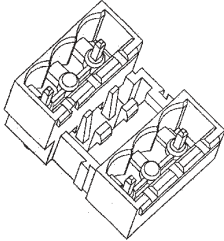

No. of Positions	Dim.		Part Numbers*
	A	B	
2	17.0 [0.669]	19.5 [0.768]	1776168-2
3	27.0 [1.063]	29.5 [1.161]	1776168-3
4	37.0 [1.457]	39.5 [1.555]	1776168-4

*Wave solder process capable to 265°C [509°F] for 10 seconds

**Vertical, Closed End
Double-Row Header
10.16 mm Centerline
Color – Black
UL Rating – 600 V, 12 A**

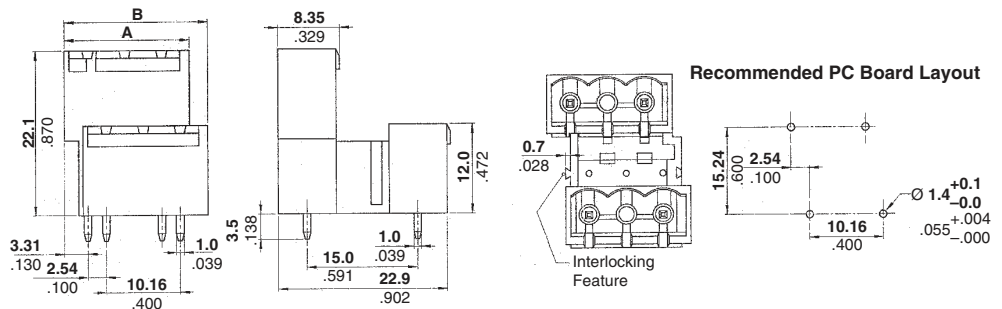
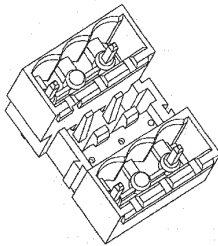

No. of Positions	Dim.		Part Numbers*
	A	B	
2	17.28 [0.68]	19.82 [0.78]	1776169-2
3	27.44 [1.08]	29.98 [1.18]	1776169-3
4	37.60 [1.48]	40.14 [1.58]	1776169-4

*Wave solder process capable to 265°C [509°F] for 10 seconds

Note: All part numbers are RoHS Compliant.

Two-Piece Terminal Block Connectors (Continued)

Right-Angle, Open End Double-Row Header w/Interlock, 5.0 mm Centerline Color – Green UL Rating – 300 V, 12 A

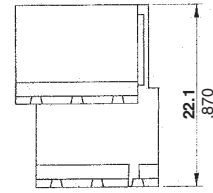
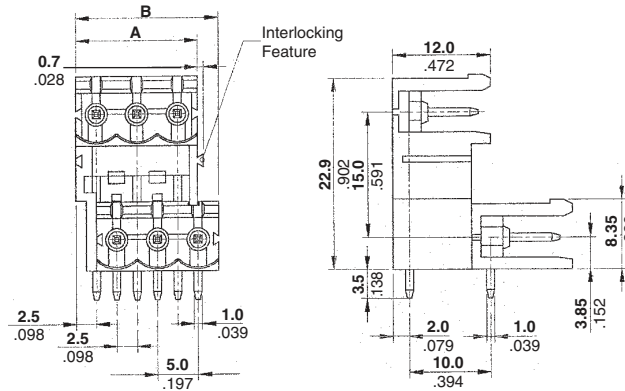
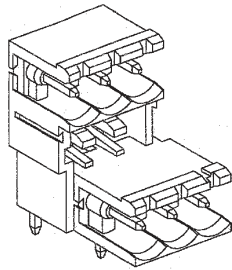

Recommended PC Board Layout

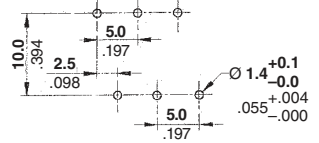

No. of Positions	Dim.		Part Numbers
	A	B	
2	10.0 [.394]	12.5 [.492]	284052-2
3	15.0 [.591]	17.5 [.689]	284052-3

Right-Angle, Open End Double-Row Header w/Interlock, 5.08 mm Centerline Color – See chart. UL Rating – 300 V, 12 A

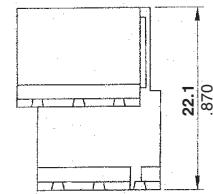
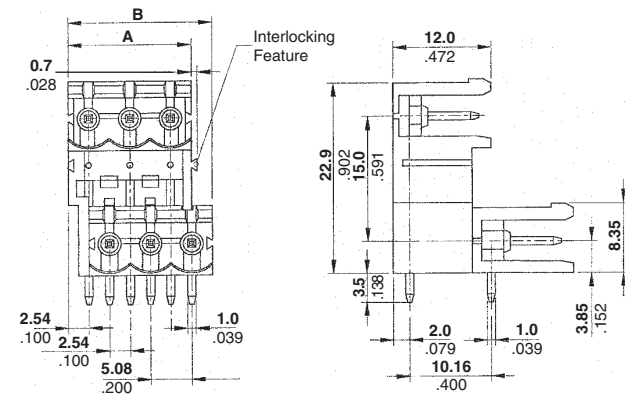
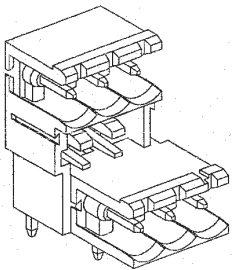

Recommended PC Board Layout

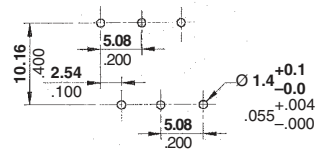

No. of Positions	Dim.		Part Numbers	
	A	B	Green	Gray
2	10.16 [.400]	12.70 [.500]	284053-2	1546237-2
3	15.24 [.600]	17.78 [.700]	284053-3	1546237-3

Note: All part numbers are RoHS Compliant.

Two-Piece Terminal Block Connectors (Continued)

Right-Angle, Closed End Double-Row Header w/Interlock, 5.0 mm Centerline Color – Black
UL Rating – 300 V, 12 A

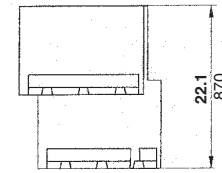
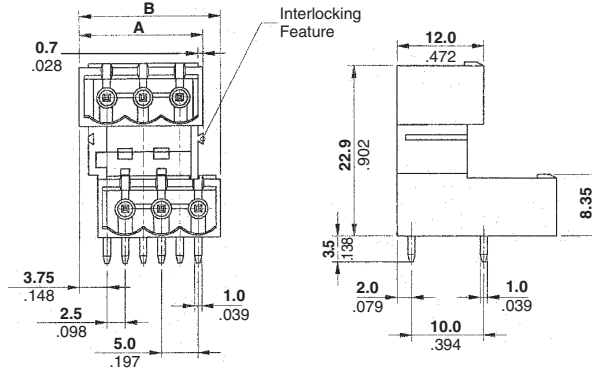
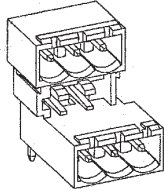

Recommended PC Board Layout

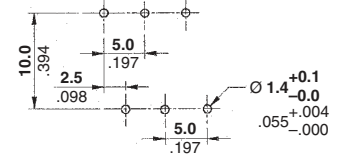

No. of Positions	Dim.		Part Numbers*
	A	B	
2	12.0 [0.472]	14.5 [0.571]	1776166-2
3	17.0 [0.669]	19.5 [0.768]	1776166-3
4	22.0 [0.866]	24.5 [0.965]	1776166-4
5	27.0 [1.063]	29.5 [1.161]	1776166-5
6	32.0 [1.260]	34.5 [1.358]	1776166-6
7	37.0 [1.457]	39.5 [1.555]	1776166-7
8	42.0 [1.654]	44.5 [1.752]	1776166-8

*Wave solder process capable to 265°C [509°F] for 10 seconds

Right-Angle, Closed End Double-Row Header w/Interlock, 5.08 mm Centerline
UL Rating – 300 V, 12 A

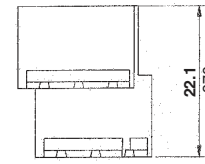
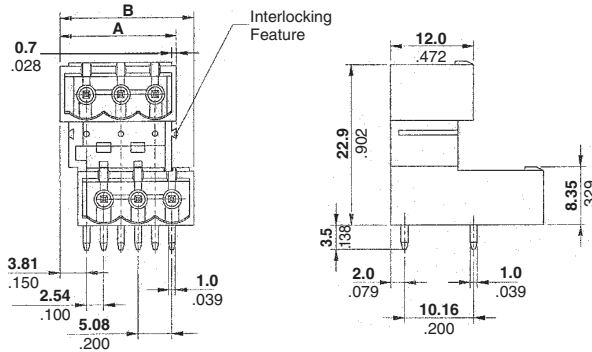
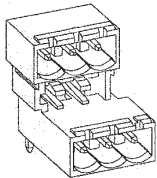

Recommended PC Board Layout

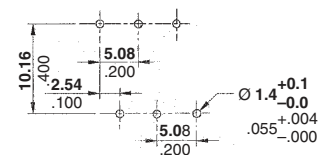

No. of Positions	Dim.		Part Numbers	
	A	B	Green	Black*
2	12.20 [0.48]	14.74 [0.58]	284061-2	1776167-2
3	17.28 [0.68]	19.82 [0.78]	284061-3	1776167-3
4	22.36 [0.88]	24.90 [0.98]	284061-4	1776167-4
5	27.44 [1.08]	29.98 [1.18]	284061-5	1776167-5
6	32.52 [1.28]	35.06 [1.38]	284061-6	1776167-6
7	37.60 [1.48]	40.14 [1.58]	284061-7	1776167-7
8	42.68 [1.68]	45.22 [1.78]	284061-8	1776167-8
9	47.76 [1.88]	50.30 [1.98]	284061-9	—
10	52.84 [2.08]	55.38 [2.18]	1-284061-0	—
11	57.92 [2.28]	60.46 [2.68]	1-284061-1	—
12	63.00 [2.48]	65.54 [2.58]	1-284061-2	—
13	68.08 [2.68]	70.62 [2.78]	1-284061-3	—

*Wave solder process capable to 265°C [509°F] for 10 seconds

No. of Positions	Dim.		Part Numbers	
	A	B	Green	Black*
14	73.16 [2.88]	75.70 [2.98]	1-284061-4	—
15	78.24 [3.08]	80.78 [3.18]	1-284061-5	—
16	83.32 [3.28]	85.86 [3.38]	1-284061-6	—
17	88.40 [3.48]	90.94 [3.58]	1-284061-7	—
18	93.48 [3.68]	96.02 [3.78]	1-284061-8	—
19	98.56 [3.88]	101.10 [3.98]	1-284061-9	—
20	103.64 [4.08]	106.18 [4.18]	2-284061-0	—
21	108.72 [4.48]	111.26 [4.38]	2-284061-1	—
22	113.80 [4.88]	116.34 [4.58]	2-284061-2	—
23	118.88 [4.68]	121.42 [4.78]	2-284061-3	—
24	123.96 [4.88]	126.50 [4.98]	2-284061-4	—
25	129.04 [5.08]	131.58 [5.18]	2-284061-5	—



Note: All part numbers are RoHS Compliant.

Two-Piece Terminal Block Connectors (Continued)

Right-Angle, Closed End Double-Row Header w/Interlock, 10.0 mm Centerline Color – Black
UL Rating – 600 V, 12 A

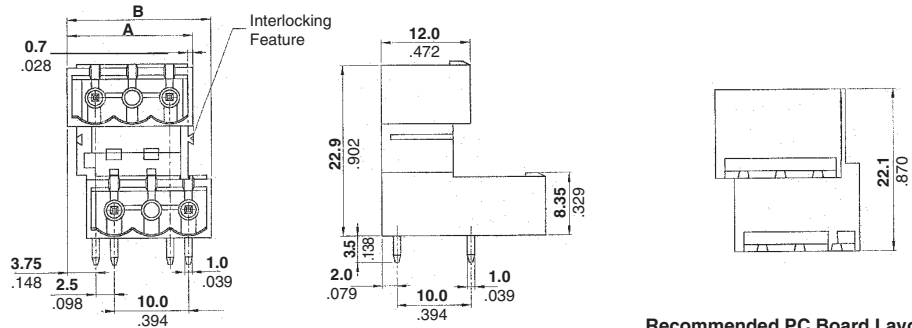
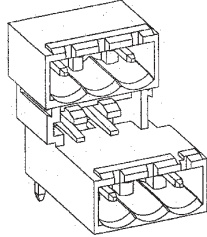

Recommended PC Board Layout

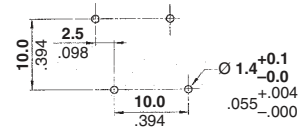

No. of Positions	Dim.		Part Numbers*
	A	B	
2	17.0 [0.669]	19.5 [0.768]	1776170-2
3	27.0 [1.063]	29.5 [1.161]	1776170-3
4	37.0 [1.457]	39.5 [1.555]	1776170-4

*Wave solder process capable to 265°C [509°F] for 10 seconds

Right-Angle, Closed End Double-Row Header w/Interlock, 10.16 mm Centerline Color – Black
UL Rating – 600 V, 12 A

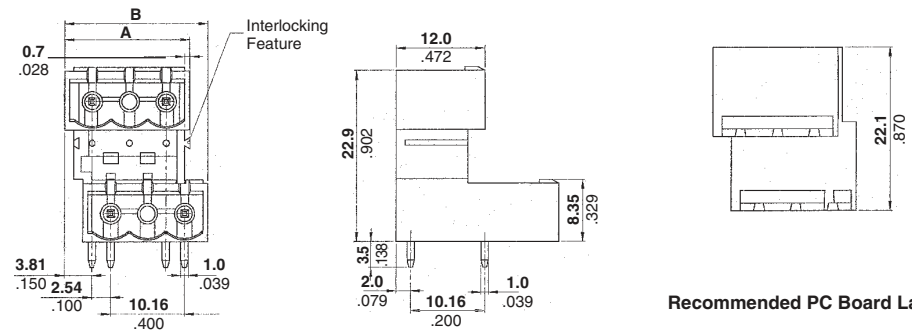
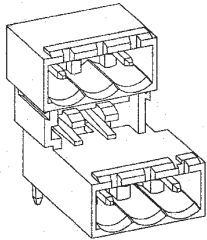

Recommended PC Board Layout

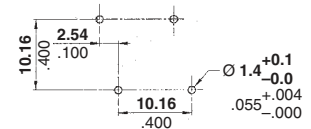

No. of Positions	Dim.		Part Numbers*
	A	B	
2	17.28 [0.68]	19.82 [0.78]	1776171-2
3	27.44 [1.08]	29.98 [1.18]	1776171-3
4	37.60 [1.48]	40.14 [1.58]	1776171-4

*Wave solder process capable to 265°C [509°F] for 10 seconds

Two-Piece Terminal Block Connectors (Continued)

Plug, Right-Angle w/Screw Flange
3.5 mm Centerline
Color – Green
UL Rating – 300 V, 11 A
14-30 AWG

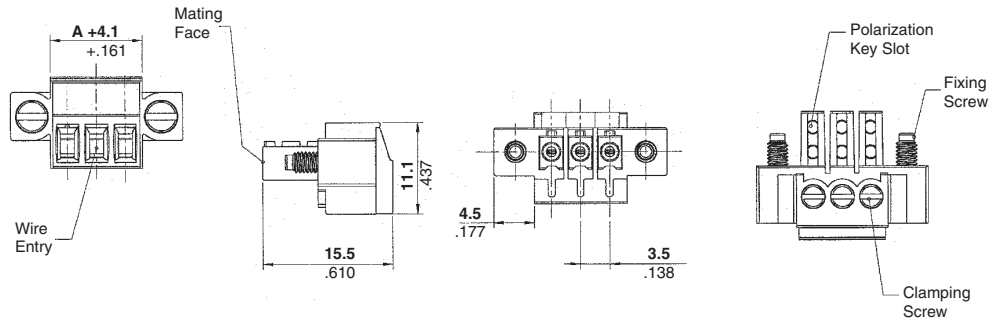
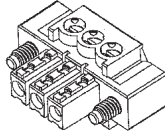

Suggested Screw Torque—
2.7 in.-lb.

No. of Positions	Dim. A	Part Numbers
2	3.5 [0.138]	284510-2
3	7.0 [0.276]	284510-3
4	10.5 [0.413]	284510-4
5	14.0 [0.551]	284510-5
6	17.5 [0.689]	284510-6
7	21.0 [0.827]	284510-7
8	24.5 [0.965]	284510-8
9	28.0 [1.102]	284510-9
10	31.5 [1.240]	1-284510-0
11	35.0 [1.378]	1-284510-1
12	38.5 [1.516]	1-284510-2

No. of Positions	Dim. A	Part Numbers
13	42.0 [1.654]	1-284510-3
14	45.5 [1.791]	1-284510-4
15	49.0 [1.929]	1-284510-5
16	52.5 [2.067]	1-284510-6
17	56.0 [2.205]	1-284510-7
18	59.5 [2.343]	1-284510-8
19	63.0 [2.480]	1-284510-9
20	66.5 [2.618]	2-284510-0
21	70.0 [2.756]	2-284510-1
22	73.5 [2.894]	2-284510-2
23	77.0 [3.031]	2-284510-3

Plug, Right-Angle w/Screw Flange
3.81 mm Centerline
Color – Green
UL Rating – 300 V, 11 A
14-30 AWG

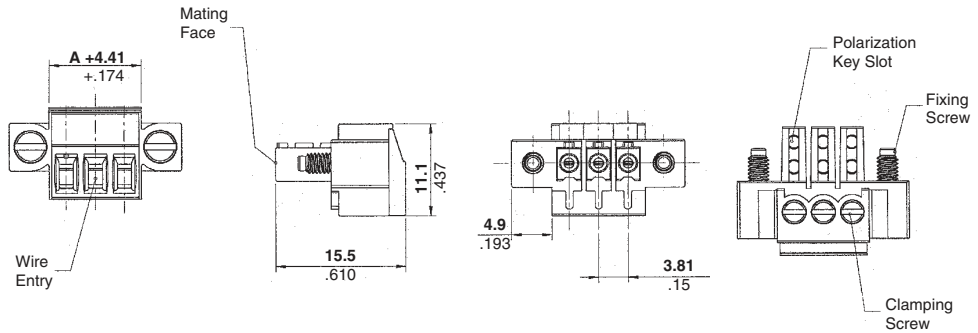
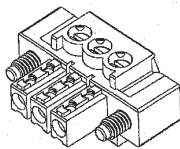

Suggested Screw Torque—
2.7 in.-lb.

No. of Positions	Dim. A	Part Numbers
2	3.81 [0.15]	284511-2
3	7.62 [0.30]	284511-3
4	11.43 [0.45]	284511-4
5	15.24 [0.60]	284511-5
6	19.05 [0.75]	284511-6
7	22.86 [0.90]	284511-7
8	26.67 [1.05]	284511-8
9	30.48 [1.20]	284511-9
10	34.29 [1.35]	1-284511-0
11	38.10 [1.50]	1-284511-1
12	41.91 [1.65]	1-284511-2

No. of Positions	Dim. A	Part Numbers
13	45.72 [1.80]	1-284511-3
14	49.53 [1.95]	1-284511-4
15	53.34 [2.10]	1-284511-5
16	57.15 [2.25]	1-284511-6
17	60.96 [2.40]	1-284511-7
18	64.77 [2.55]	1-284511-8
19	68.58 [2.70]	1-284511-9
20	72.39 [2.85]	2-284511-0
21	76.20 [3.00]	2-284511-1
22	80.01 [3.15]	2-284511-2
23	83.82 [3.30]	2-284511-3

Note: All part numbers are RoHS Compliant.

Two-Piece Terminal Block Connectors (Continued)

Plug, Right-Angle w/Locking Screw Flange, 5.0 mm Centerline Color – Green

UL Rating – 300 V, 15 A 12-30 AWG

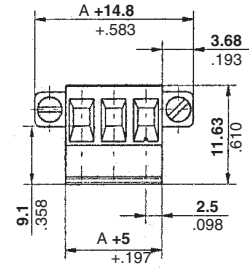
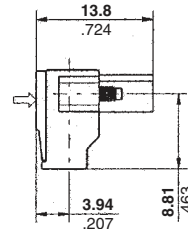
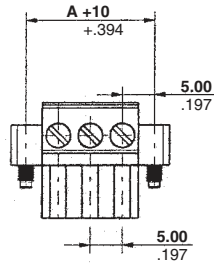
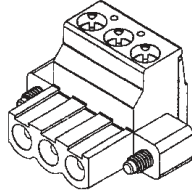

Suggested Screw Torque—
7.0 in.-lb.

No. of Positions	Dim. A	Part Numbers
2	5.0 [0.197]	796858-2
3	10.0 [0.394]	796858-3
4	15.0 [0.591]	796858-4
5	20.0 [0.787]	796858-5
6	25.0 [0.984]	796858-6
7	30.0 [1.181]	796858-7
8	35.0 [1.378]	796858-8

Plug, Right-Angle w/Locking Screw Flange, 5.08 mm Centerline Color – Green

UL Rating – 300 V, 15 A 12-30 AWG

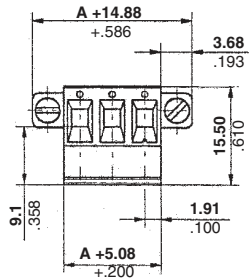
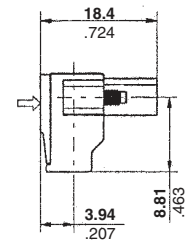
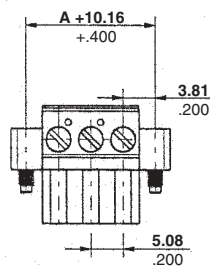
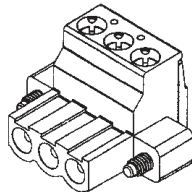

Suggested Screw Torque—
7.0 in.-lb.

No. of Positions	Dim. A	Part Numbers
2	5.08 [0.20]	796859-2
3	10.16 [0.40]	796859-3
4	15.24 [0.60]	796859-4
5	20.32 [0.80]	796859-5
6	25.40 [1.00]	796859-6
7	30.48 [1.20]	796859-7
8	35.56 [1.40]	796859-8
9	40.64 [1.60]	796859-9
10	45.72 [1.80]	1-796859-0
11	50.80 [2.00]	1-796859-1
12	55.88 [2.20]	1-796859-2

No. of Positions	Dim. A	Part Numbers
13	60.96 [2.40]	1-796859-3
14	66.04 [2.60]	1-796859-4
15	71.12 [2.80]	1-796859-5
16	76.20 [3.00]	1-796859-6
17	81.28 [3.20]	1-796859-7
18	86.36 [3.40]	1-796859-8
19	91.44 [3.60]	1-796859-9
20	96.52 [3.80]	2-796859-0
21	101.60 [4.00]	2-796859-1
22	106.68 [4.20]	2-796859-2
23	111.76 [4.40]	2-796859-3

Two-Piece Terminal Block Connectors (Continued)

**Plug (Left-Hand Version),
Straight w/Locking Screw
Flange,
5.08 mm Centerline
Color – Green**

**UL Rating – 300 V, 15 A
12-30 AWG**

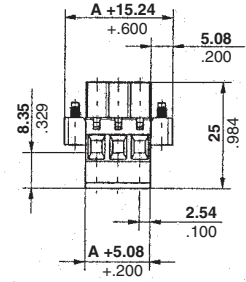
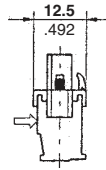
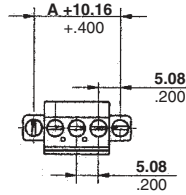
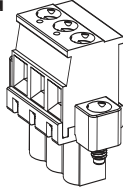

**Suggested Screw Torque—
7.0 in.-lb.**

No. of Positions	Dim. A	Part Numbers
2	5.08 [0.20]	796861-2
3	10.16 [0.40]	796861-3
4	15.24 [0.60]	796861-4
5	20.32 [0.80]	796861-5
6	25.40 [1.00]	796861-6
7	30.48 [1.20]	796861-7
8	35.56 [1.40]	796861-8
9	40.64 [1.60]	796861-9
10	45.72 [1.80]	1-796861-0
11	50.80 [2.00]	1-796861-1
12	55.88 [2.20]	1-796861-2

No. of Positions	Dim. A	Part Numbers
13	60.96 [2.40]	1-796861-3
14	66.04 [2.60]	1-796861-4
15	71.12 [2.80]	1-796861-5
16	76.20 [3.00]	1-796861-6
17	81.28 [3.20]	1-796861-7
18	86.36 [3.40]	1-796861-8
19	91.44 [3.60]	1-796861-9
20	96.52 [3.80]	2-796861-0
21	101.60 [4.00]	2-796861-1
22	106.68 [4.20]	2-796861-2
23	111.76 [4.40]	2-796861-3

**Plug (Right-Hand Version),
Straight w/Locking Screw
Flange,
5.08 mm Centerline
Color – Green**

**UL Rating – 300 V, 15 A
12-30 AWG**

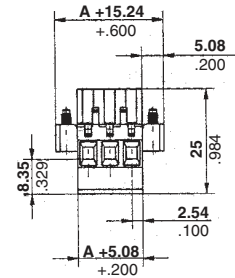
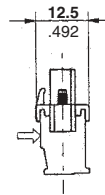
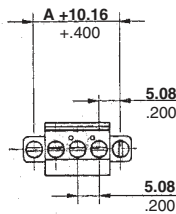
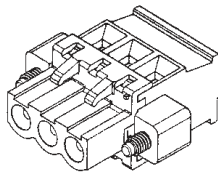

**Suggested Screw Torque—
7.0 in.-lb.**

No. of Positions	Dim. A	Part Numbers
2	5.08 [0.20]	796863-2
3	10.16 [0.40]	796863-3
4	15.24 [0.60]	796863-4
5	20.32 [0.80]	796863-5
6	25.40 [1.00]	796863-6
7	30.48 [1.20]	796863-7
8	35.56 [1.40]	796863-8
9	40.64 [1.60]	796863-9
10	45.72 [1.80]	1-796863-0
11	50.80 [2.00]	1-796863-1
12	55.88 [2.20]	1-796863-2

No. of Positions	Dim. A	Part Numbers
13	60.96 [2.40]	1-796863-3
14	66.04 [2.60]	1-796863-4
15	71.12 [2.80]	1-796863-5
16	76.20 [3.00]	1-796863-6
17	81.28 [3.20]	1-796863-7
18	86.36 [3.40]	1-796863-8
19	91.44 [3.60]	1-796863-9
20	96.52 [3.80]	2-796863-0
21	101.60 [4.00]	2-796863-1
22	106.68 [4.20]	2-796863-2
23	111.76 [4.40]	2-796863-3

Note: All part numbers are RoHS Compliant.

Two-Piece Terminal Block Connectors (Continued)

**Plug, Right-Angle,
3.5 mm Centerline
Colors – See chart.**

**UL Rating – 300 V, 11 A
14-30 AWG**

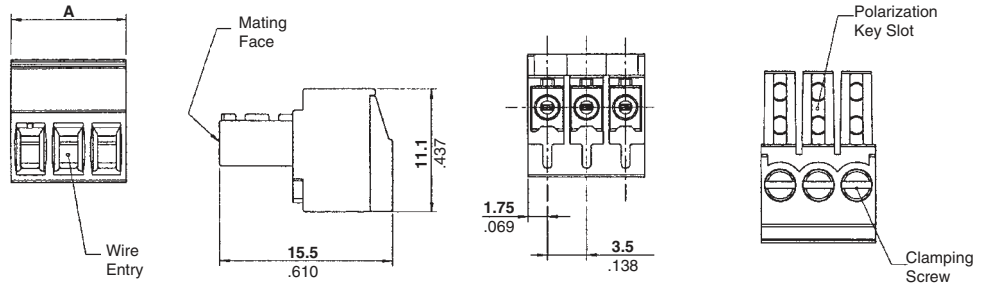
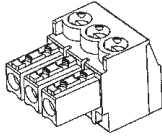

Suggested Screw Torque— 2.7 in.-lb.

No. of Positions	Dim. A	Part Numbers	
		Green	Blue
2	7.0 [0.276]	284506-2	796693-2
3	10.5 [0.413]	284506-3	796693-3
4	14.0 [0.551]	284506-4	796693-4
5	17.5 [0.689]	284506-5	796693-5
6	21.0 [0.827]	284506-6	796693-6
7	24.5 [0.965]	284506-7	796693-7
8	28.0 [1.102]	284506-8	796693-8
9	31.5 [1.240]	284506-9	796693-9
10	35.0 [1.378]	1-284506-0	1-796693-0
11	38.5 [1.516]	1-284506-1	1-796693-1
12	42.0 [1.654]	1-284506-2	1-796693-2
13	45.5 [1.791]	1-284506-3	1-796693-3

No. of Positions	Dim. A	Part Numbers	
		Green	Blue
14	49.0 [1.929]	1-284506-4	1-796693-4
15	52.5 [2.067]	1-284506-5	1-796693-5
16	56.0 [2.205]	1-284506-6	1-796693-6
17	59.5 [2.343]	1-284506-7	1-796693-7
18	63.0 [2.450]	1-284506-8	1-796693-8
19	66.5 [2.618]	1-284506-9	1-796693-9
20	70.0 [2.756]	2-284506-0	2-796693-0
21	73.5 [2.894]	2-284506-1	2-796693-1
22	77.0 [3.031]	2-284506-2	2-796693-2
23	80.5 [3.169]	2-284506-3	2-796693-3
24	84.0 [3.307]	2-284506-4	2-796693-4
25	87.5 [3.445]	2-284506-5	2-796693-5

Note: BUCHANAN Terminal Block Series B52C3UxxT has been superseded/replaced with 796693-xx (blue).

**Plug, Right-Angle,
3.81 mm Centerline
Color – Green**

**UL Rating – 300 V, 11 A
14-30 AWG**

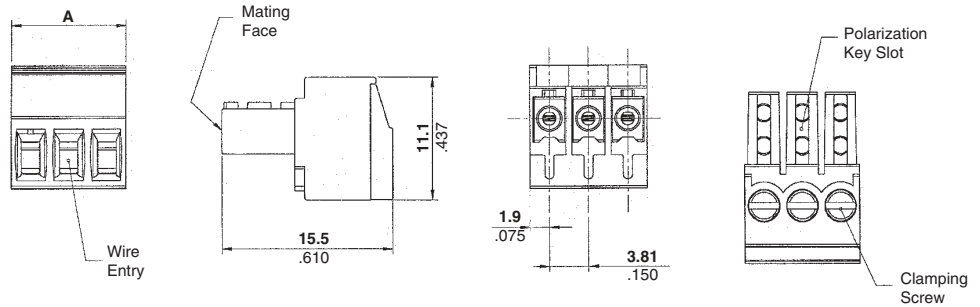
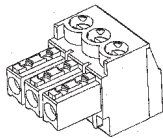

Suggested Screw Torque— 2.7 in.-lb.

No. of Positions	Dim. A	Part Numbers
2	7.62 [0.30]	284507-2
3	11.43 [0.45]	284507-3
4	15.24 [0.60]	284507-4
5	19.05 [0.75]	284507-5
6	22.86 [0.90]	284507-6
7	26.67 [1.05]	284507-7
8	30.48 [1.20]	284507-8
9	34.29 [1.35]	284507-9
10	38.10 [1.50]	1-284507-0
11	41.91 [1.65]	1-284507-1
12	45.72 [1.80]	1-284507-2
13	49.53 [1.95]	1-284507-3

No. of Positions	Dim. A	Part Numbers
14	53.34 [2.10]	1-284507-4
15	57.15 [2.25]	1-284507-5
16	60.96 [2.40]	1-284507-6
17	64.77 [2.55]	1-284507-7
18	68.58 [2.70]	1-284507-8
19	72.39 [2.85]	1-284507-9
20	76.20 [3.00]	2-284507-0
21	80.01 [3.15]	2-284507-1
22	83.82 [3.30]	2-284507-2
23	87.63 [3.45]	2-284507-3
24	91.44 [3.60]	2-284507-4
25	95.25 [3.75]	2-284507-5

Note: All part numbers are RoHS Compliant.

Two-Piece Terminal Block Connectors (Continued)

Plug, Right-Angle, 5.0 mm Centerline Colors – See chart.

UL Rating – 300 V, 15 A 12-30 AWG

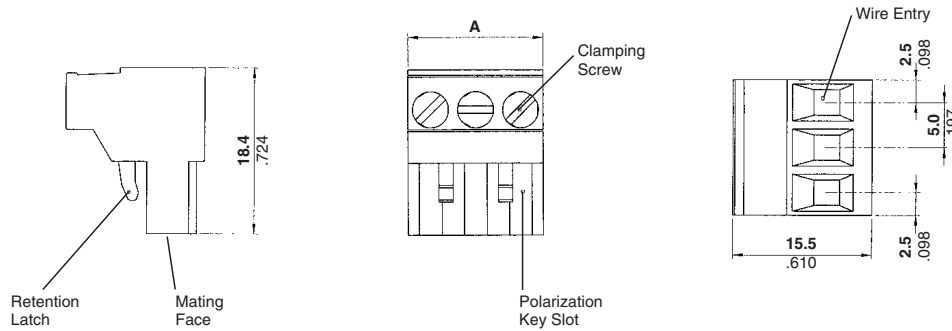
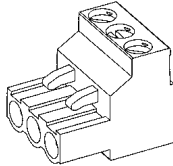

Suggested Screw Torque—
7.0 in.-lb.

No. of Positions	Dim. A	Part Numbers			
		Gray	Green	Blue	Black
2	10.0 [0.394]	1546208-2	796640-2	796696-2	796641-2
3	15.0 [0.591]	1546208-3	796640-3	796696-3	796641-3
4	20.0 [0.787]	1546208-4	796640-4	796696-4	796641-4
5	25.0 [0.984]	1546208-5	796640-5	796696-5	796641-5
6	30.0 [1.181]	1546208-6	796640-6	796696-6	796641-6
7	35.0 [1.378]	1546208-7	796640-7	796696-7	796641-7
8	40.0 [1.575]	1546208-8	796640-8	796696-8	796641-8
9	45.0 [1.772]	1546208-9	796640-9	796696-9	796641-9
10	50.0 [1.968]	1-1546208-0	1-796640-0	1-796696-0	1-796641-0
11	55.0 [2.165]	1-1546208-1	1-796640-1	1-796696-1	1-796641-1
12	60.0 [2.362]	1-1546208-2	1-796640-2	1-796696-2	1-796641-2
13	65.0 [2.559]	1-1546208-3	1-796640-3	1-796696-3	1-796641-3

No. of Positions	Dim. A	Part Numbers			
		Gray	Green	Blue	Black
14	70.0 [2.756]	1-1546208-4	1-796640-4	1-796696-4	1-796641-4
15	75.0 [2.953]	1-1546208-5	1-796640-5	1-796696-5	1-796641-5
16	80.0 [3.150]	1-1546208-6	1-796640-6	1-796696-6	1-796641-6
17	85.0 [3.346]	1-1546208-7	1-796640-7	1-796696-7	1-796641-7
18	90.0 [3.543]	1-1546208-8	1-796640-8	1-796696-8	1-796641-8
19	95.0 [3.740]	1-1546208-9	1-796640-9	1-796696-9	1-796641-9
20	100.0 [3.937]	2-1546208-0	2-796640-0	2-796696-0	2-796641-0
21	105.0 [4.134]	2-1546208-1	2-796640-1	2-796696-1	2-796641-1
22	110.0 [4.331]	2-1546208-2	2-796640-2	2-796696-2	2-796641-2
23	115.0 [4.528]	2-1546208-3	2-796640-3	2-796696-3	2-796641-3
24	120.0 [4.724]	2-1546208-4	2-796640-4	2-796696-4	2-796641-4
25	125.0 [4.921]	2-1546208-5	2-796640-5	2-796696-5	2-796641-5

Note: BUCHANAN Terminal Block Series B52C4UxxT has been replaced with 796696-xx (blue) and 796641-xx (black). RDI Terminal Block Series 5ESDV-xx has been replaced with 796640-xx (green) or 796641-xx (black).

Plug, Right-Angle, 5.08 mm Centerline Colors – See chart.

UL Rating – 300 V, 15 A 12-30 AWG

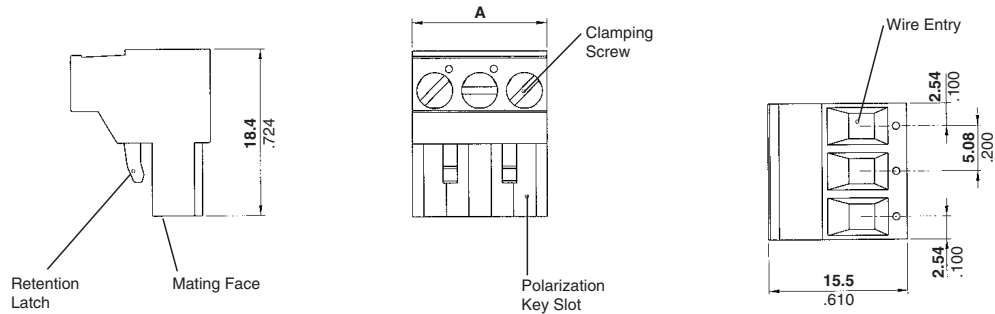
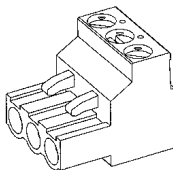

Suggested Screw Torque—
7.0 in.-lb.

No. of Positions	Dim. A	Part Numbers		
		Gray	Green	Black
2	10.16 [0.40]	1546108-2	796634-2	796635-2
3	15.24 [0.60]	1546108-3	796634-3	796635-3
4	20.32 [0.80]	1546108-4	796634-4	796635-4
5	25.40 [1.00]	1546108-5	796634-5	796635-5
6	30.48 [1.20]	1546108-6	796634-6	796635-6
7	35.56 [1.40]	1546108-7	796634-7	796635-7
8	40.64 [1.60]	1546108-8	796634-8	796635-8
9	45.72 [1.80]	1546108-9	796634-9	796635-9
10	50.80 [2.00]	1-1546108-0	1-796634-0	1-796635-0
11	55.88 [2.20]	1-1546108-1	1-796634-1	1-796635-1
12	60.96 [2.40]	1-1546108-2	1-796634-2	1-796635-2
13	66.04 [2.60]	1-1546108-3	1-796634-3	1-796635-3

No. of Positions	Dim. A	Part Numbers		
		Gray	Green	Black
14	71.12 [2.80]	1-1546108-4	1-796634-4	1-796635-4
15	76.20 [3.00]	1-1546108-5	1-796634-5	1-796635-5
16	81.28 [3.20]	1-1546108-6	1-796634-6	1-796635-6
17	86.36 [3.40]	1-1546108-7	1-796634-7	1-796635-7
18	91.44 [3.60]	1-1546108-8	1-796634-8	1-796635-8
19	96.52 [3.80]	1-1546108-9	1-796634-9	1-796635-9
20	101.60 [4.00]	2-1546108-0	2-796634-0	2-796635-0
21	106.68 [4.20]	2-1546108-1	2-796634-1	2-796635-1
22	111.76 [4.40]	2-1546108-2	2-796634-2	2-796635-2
23	116.84 [4.60]	2-1546108-3	2-796634-3	2-796635-3
24	121.92 [4.80]	2-1546108-4	2-796634-4	2-796635-4
25	127.00 [5.00]	2-1546108-5	2-796634-5	2-796635-5

Note: RDI Terminal Block Series 2ESDV-xx has been replaced with 796634-xx (green) and 796635-xx (black).



Two-Piece Terminal Block Connectors (Continued)

**Plug, Right-Angle,
7.5 mm Centerline
Color – Green**

**UL Rating – 300 V, 15 A
12-30 AWG**

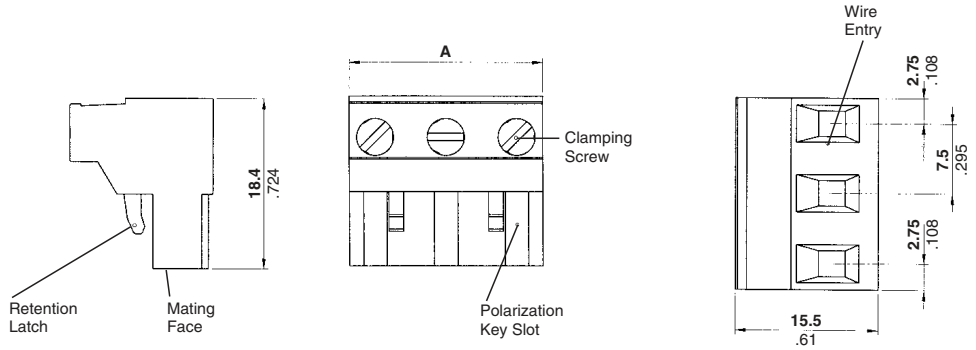
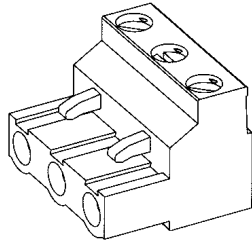

Suggested Screw Torque—
7.0 in.-lb.

No. of Positions	Dim. A	Part Numbers
2	13.0 [0.512]	282959-2
3	20.5 [0.807]	282959-3
4	28.0 [1.102]	282959-4
5	35.5 [1.398]	282959-5
6	43.0 [1.693]	282959-6
7	50.5 [1.988]	282959-7

No. of Positions	Dim. A	Part Numbers
8	58.0 [2.283]	282959-8
9	65.5 [2.579]	282959-9
10	73.0 [2.874]	1-282959-0
11	80.5 [3.169]	1-282959-1
12	88.0 [3.465]	1-282959-2

**Plug, Right-Angle,
7.62 mm Centerline
Color – Green**

**UL Rating – 300 V, 15 A
12-30 AWG**

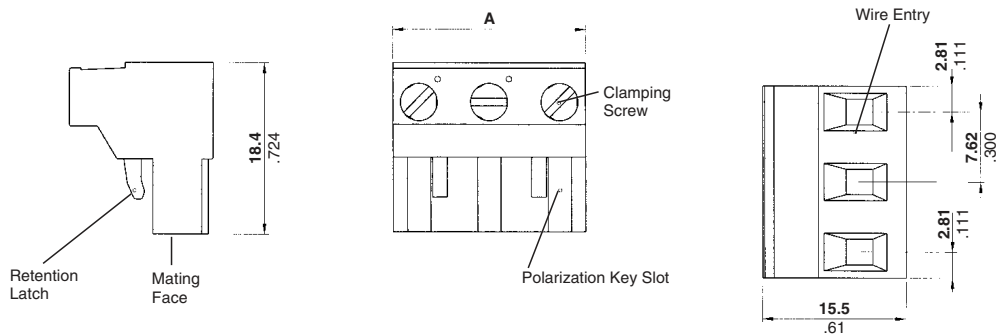
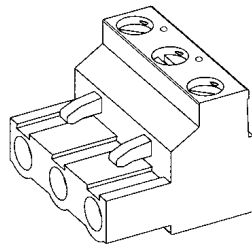

Suggested Screw Torque—
7.0 in.-lb.

No. of Positions	Dim. A	Part Numbers
2	13.24 [0.521]	796981-2
3	20.86 [0.821]	796981-3
4	28.48 [1.121]	796981-4
5	36.10 [1.421]	796981-5
6	43.72 [1.721]	796981-6
7	51.34 [2.021]	796981-7

No. of Positions	Dim. A	Part Numbers
8	58.96 [2.321]	796981-8
9	66.58 [2.621]	796981-9
10	74.20 [2.921]	1-796981-0
11	81.82 [3.221]	1-796981-1
12	89.44 [3.521]	1-796981-2

Note: All part numbers are RoHS Compliant.

Two-Piece Terminal Block Connectors (Continued)

**Plug, Right-Angle,
10.0 mm Centerline
Color – Green**

**UL Rating – 600 V, 15 A
12-30 AWG**

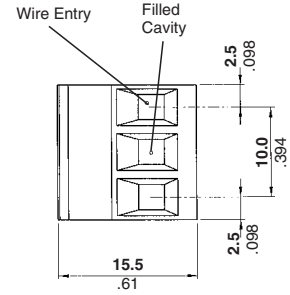
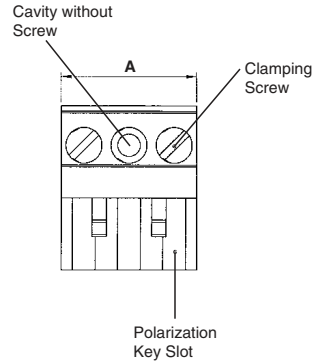
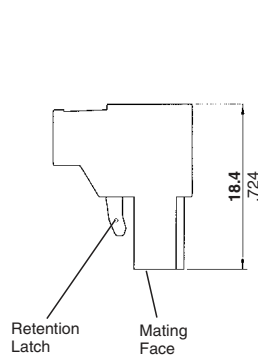
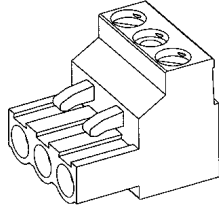

Suggested Screw Torque—
7.0 in.-lb.

No. of Positions	Dim. A	Part Numbers
2	15.0 [0.591]	282808-2
3	25.0 [0.984]	282808-3
4	35.0 [1.378]	282808-4
5	45.0 [1.772]	282808-5
6	55.0 [2.165]	282808-6
7	65.0 [2.559]	282808-7

No. of Positions	Dim. A	Part Numbers
8	75.0 [2.953]	282808-8
9	85.0 [3.346]	282808-9
10	95.0 [3.740]	1-282808-0
11	105.0 [4.134]	1-282808-1
12	115.0 [4.528]	1-282808-2
13	125.0 [4.921]	1-282808-3

**Plug, Right-Angle,
10.16 mm Centerline
Color – Green**

**UL Rating – 600 V, 15 A
12-30 AWG**

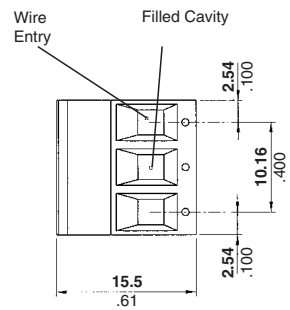
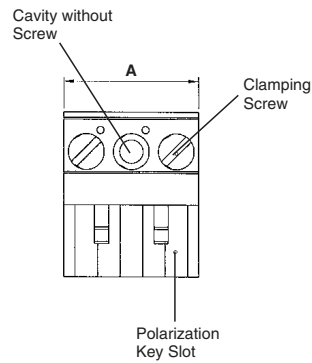
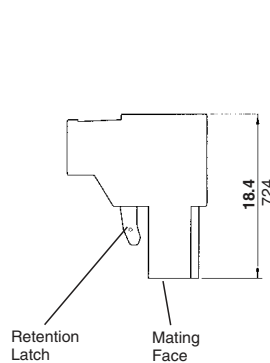
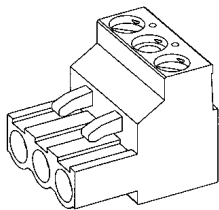

Suggested Screw Torque—
7.0 in.-lb.

No. of Positions	Dim. A	Part Numbers
2	15.24 [0.60]	282809-2
3	25.40 [1.00]	282809-3
4	35.56 [1.40]	282809-4
5	45.72 [1.80]	282809-5
6	55.88 [2.20]	282809-6
7	66.04 [2.60]	282809-7

No. of Positions	Dim. A	Part Numbers
8	76.20 [3.00]	282809-8
9	86.36 [3.40]	282809-9
10	96.52 [3.80]	1-282809-0
11	106.68 [4.20]	1-282809-1
12	116.84 [4.60]	1-282809-2
13	127.00 [5.00]	1-282809-3

Note: All part numbers are RoHS Compliant.

Two-Piece Terminal Block Connectors (Continued)

**Plug, Right-Angle w/Interlock,
3.81 mm Centerline
Color – Green**

**UL Rating – 150 V, 12 A
14-30 AWG**

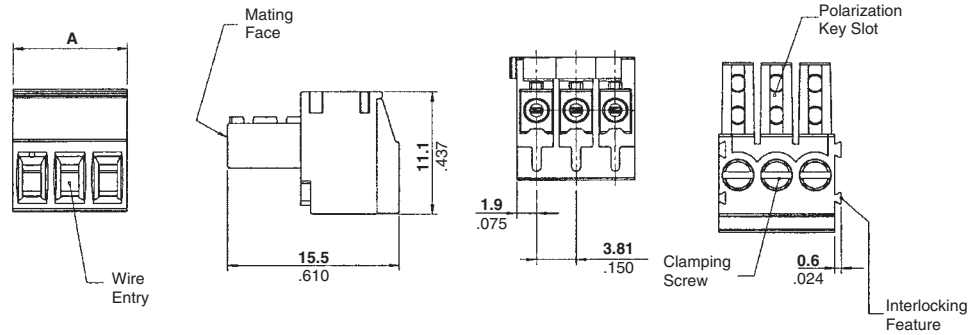
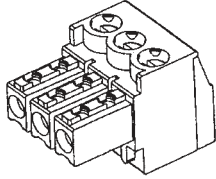

Suggested Screw Torque—
2.2 in.-lb.

No. of Positions	Dim. A	Part Numbers
2	7.62 [0.30]	284509-2
3	11.43 [0.45]	284509-3
4	15.24 [0.60]	284509-4
5	19.05 [0.75]	284509-5
6	22.86 [0.90]	284509-6
7	26.67 [1.05]	284509-7
8	30.48 [1.20]	284509-8
9	34.29 [1.35]	284509-9
10	38.10 [1.50]	1-284509-0
11	41.91 [1.65]	1-284509-1
12	45.72 [1.80]	1-284509-2
13	49.53 [1.95]	1-284509-3
14	53.34 [2.10]	1-284509-4
15	57.15 [2.25]	1-284509-5
16	60.96 [2.40]	1-284509-6
17	64.77 [2.55]	1-284509-7
18	68.58 [2.70]	1-284509-8
19	72.39 [2.85]	1-284509-9
20	86.20 [3.00]	2-284509-0
21	80.01 [3.15]	2-284509-1
22	83.82 [3.30]	2-284509-2
23	87.63 [3.45]	2-284509-3
24	91.44 [3.60]	2-284509-4
25	95.25 [3.75]	2-284509-5

Two-Piece Terminal Block Connectors (Continued)

Stacking Plug, Right-Angle with Interlock, 5.0 mm Centerline Color – Green

**UL Rating – 300 V, 15 A
12-30 AWG**

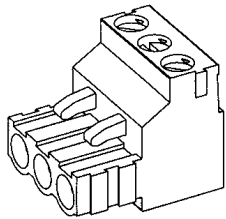

**Suggested Screw Torque—
7.0 in.-lb.**

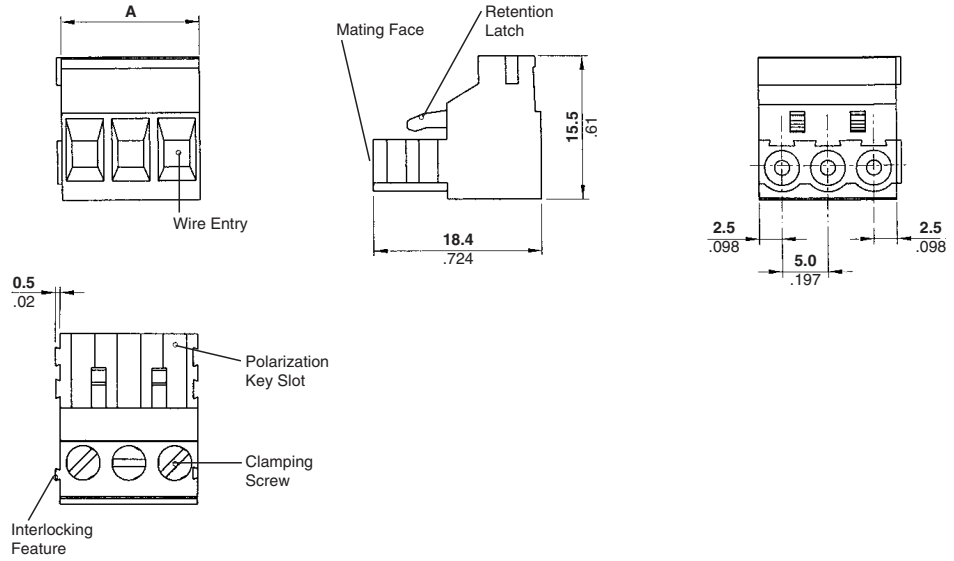

No. of Positions	Dim. A	Part Numbers
2	10.0 [.394]	282805-2
3	15.0 [.591]	282805-3
4	20.0 [.787]	282805-4

Stacking Plug, Right-Angle with Interlock, 5.08 mm Centerline Color – Green

**UL Rating – 300 V, 15 A
12-30 AWG**

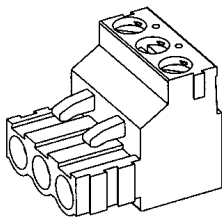

**Suggested Screw Torque—
7.0 in.-lb.**

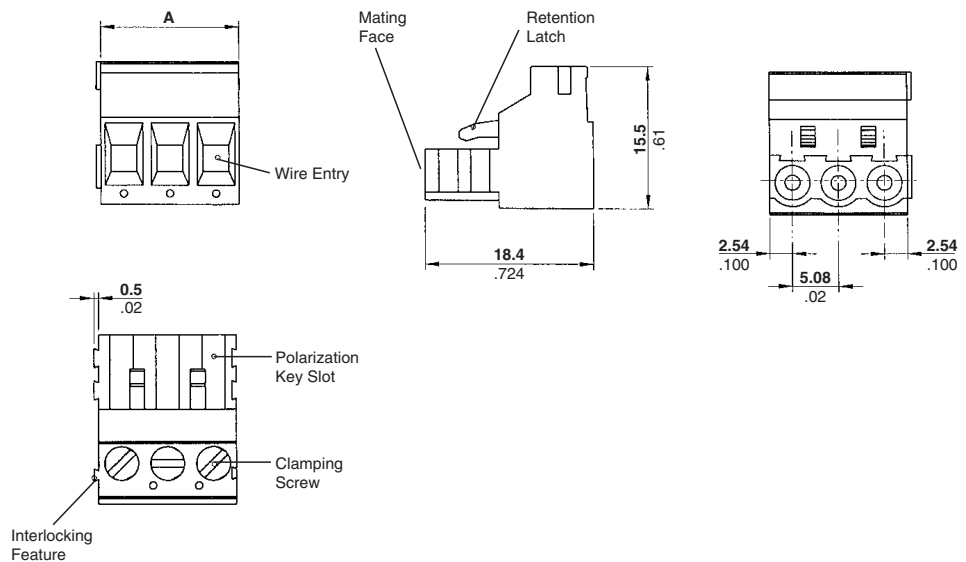

No. of Positions	Dim. A	Part Numbers
2	10.16 [.400]	282807-2
3	15.24 [.600]	282807-3
4	20.32 [.800]	282807-4

Straight Plugs

**Plug, Straight,
5.0 mm Centerline
Color – See chart.**

**UL Rating – 300 V, 15 A
12-30 AWG**

**Suggested Screw Torque—
7.0 in.-lbs.**

Left-Hand Version

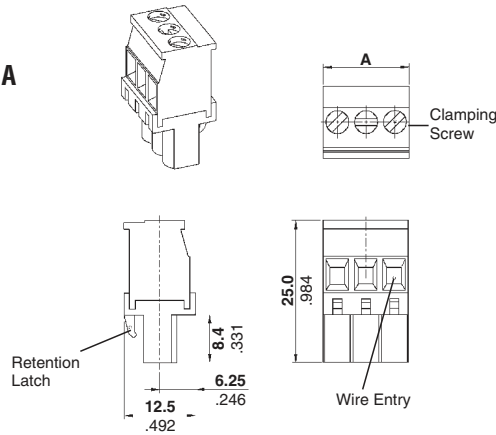

Right-Hand Version

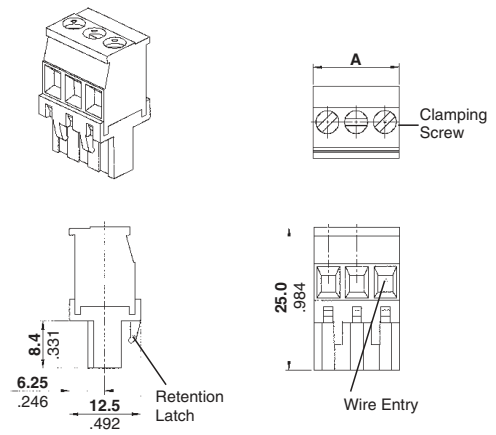

No. of Positions	Dim. A	Part Numbers					
		Left-Hand			Right-Hand		
		Green	Black	Gray	Green	Black	Gray
2	10.0 [.394]	284040-2	1546118-2	1546223-2	284046-2	1546625-2	1546857-2
3	15.0 [.591]	284040-3	1546118-3	1546223-3	284046-3	1546625-3	1546857-3
4	20.0 [.787]	284040-4	1546118-4	1546223-4	284046-4	1546625-4	1546857-4
5	25.0 [.984]	284040-5	1546118-5	1546223-5	284046-5	1546625-5	1546857-5
6	30.0 [1.181]	284040-6	1546118-6	1546223-6	284046-6	1546625-6	1546857-6
7	35.0 [1.378]	284040-7	1546118-7	1546223-7	284046-7	1546625-7	1546857-7
8	40.0 [1.575]	284040-8	1546118-8	1546223-8	284046-8	1546625-8	1546857-8
9	45.0 [1.772]	284040-9	1546118-9	1546223-9	284046-9	1546625-9	1546857-9
10	50.0 [1.968]	1-284040-0	1-1546118-0	1-1546223-0	1-284046-0	1-1546625-0	1-1546857-0
11	55.0 [2.165]	1-284040-1	1-1546118-1	1-1546223-1	1-284046-1	1-1546625-1	1-1546857-1
12	60.0 [2.362]	1-284040-2	1-1546118-2	1-1546223-2	1-284046-2	1-1546625-2	1-1546857-2
13	65.0 [2.559]	1-284040-3	1-1546118-3	1-1546223-3	1-284046-3	1-1546625-3	1-1546857-3
14	70.0 [2.756]	1-284040-4	1-1546118-4	1-1546223-4	1-284046-4	1-1546625-4	1-1546857-4
15	75.0 [2.953]	1-284040-5	1-1546118-5	1-1546223-5	1-284046-5	1-1546625-5	1-1546857-5
16	80.0 [3.150]	1-284040-6	1-1546118-6	1-1546223-6	1-284046-6	1-1546625-6	1-1546857-6
17	85.0 [3.346]	1-284040-7	1-1546118-7	1-1546223-7	1-284046-7	1-1546625-7	1-1546857-7
18	90.0 [3.543]	1-284040-8	1-1546118-8	1-1546223-8	1-284046-8	1-1546625-8	1-1546857-8
19	95.0 [3.740]	1-284040-9	1-1546118-9	1-1546223-9	1-284046-9	1-1546625-9	1-1546857-9
20	100.0 [3.937]	2-284040-0	2-1546118-0	2-1546223-0	2-284046-0	2-1546625-0	2-1546857-0
21	105.0 [4.134]	2-284040-1	2-1546118-1	2-1546223-1	2-284046-1	2-1546625-1	2-1546857-1
22	110.0 [4.331]	2-284040-2	2-1546118-2	2-1546223-2	2-284046-2	2-1546625-2	2-1546857-2
23	115.0 [4.528]	2-284040-3	2-1546118-3	2-1546223-3	2-284046-3	2-1546625-3	2-1546857-3
24	120.0 [4.724]	2-284040-4	2-1546118-4	2-1546223-4	2-284046-4	2-1546625-4	2-1546857-4
25	125.0 [4.921]	2-284040-5	2-1546118-5	2-1546223-5	2-284046-5	2-1546625-5	2-1546857-5

Note: All part numbers are RoHS Compliant.

Straight Plugs (Continued)

**Plug, Straight,
5.08 mm Centerline
Color – See chart.
UL Rating – 300 V, 15 A
12-30 AWG**

**Suggested Screw Torque—
7.0 in.-lbs.**

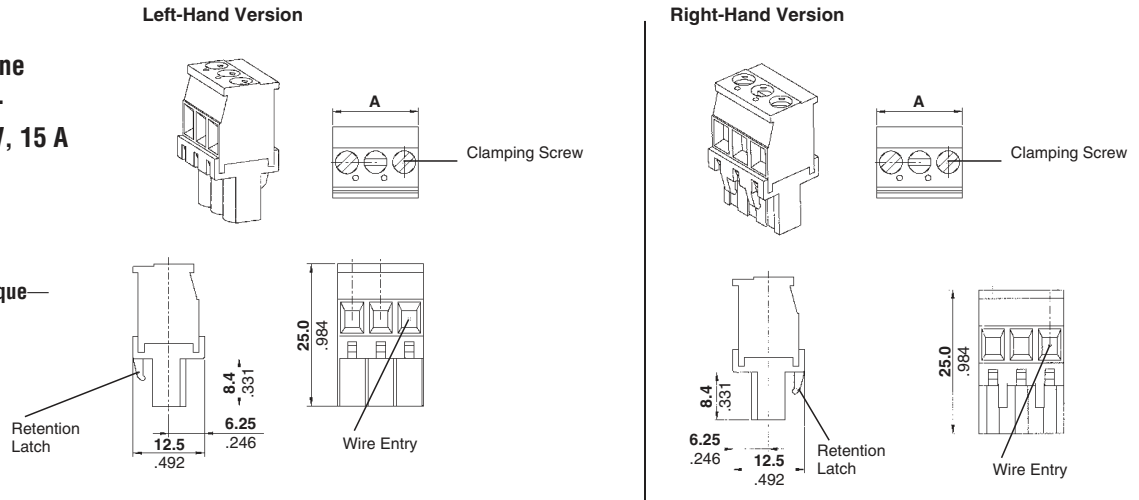

No. of Positions	Dim. A	Part Numbers					
		Left-Hand			Right-Hand		
		Green	Black	Gray	Green	Black	Gray
2	10.16 [.400]	284041-2	1546105-2	1546224-2	284047-2	1546231-2	1546122-2
3	15.24 [.600]	284041-3	1546105-3	1546224-3	284047-3	1546231-3	1546122-3
4	20.32 [.800]	284041-4	1546105-4	1546224-4	284047-4	1546231-4	1546122-4
5	25.40 [1.000]	284041-5	1546105-5	1546224-5	284047-5	1546231-5	1546122-5
6	30.48 [1.200]	284041-6	1546105-6	1546224-6	284047-6	1546231-6	1546122-6
7	35.56 [1.400]	284041-7	1546105-7	1546224-7	284047-7	1546231-7	1546122-7
8	40.64 [1.600]	284041-8	1546105-8	1546224-8	284047-8	1546231-8	1546122-8
9	45.72 [1.800]	284041-9	1546105-9	1546224-9	284047-9	1546231-9	1546122-9
10	50.80 [2.000]	1-284041-0	1-1546105-0	1-1546224-0	1-284047-0	1-1546231-0	1-1546122-0
11	55.88 [2.200]	1-284041-1	1-1546105-1	1-1546224-1	1-284047-1	1-1546231-1	1-1546122-1
12	60.96 [2.400]	1-284041-2	1-1546105-2	1-1546224-2	1-284047-2	1-1546231-2	1-1546122-2
13	66.04 [2.600]	1-284041-3	1-1546105-3	1-1546224-3	1-284047-3	1-1546231-3	1-1546122-3
14	71.12 [2.800]	1-284041-4	1-1546105-4	1-1546224-4	1-284047-4	1-1546231-4	1-1546122-4
15	76.20 [3.000]	1-284041-5	1-1546105-5	1-1546224-5	1-284047-5	1-1546231-5	1-1546122-5
16	81.28 [3.200]	1-284041-6	1-1546105-6	1-1546224-6	1-284047-6	1-1546231-6	1-1546122-6
17	86.36 [3.400]	1-284041-7	1-1546105-7	1-1546224-7	1-284047-7	1-1546231-7	1-1546122-7
18	91.44 [3.600]	1-284041-8	1-1546105-8	1-1546224-8	1-284047-8	1-1546231-8	1-1546122-8
19	96.52 [3.800]	1-284041-9	1-1546105-9	1-1546224-9	1-284047-9	1-1546231-9	1-1546122-9
20	101.60 [4.000]	2-284041-0	2-1546105-0	2-1546224-0	2-284047-0	2-1546231-0	2-1546122-0
21	106.68 [4.200]	2-284041-1	2-1546105-1	2-1546224-1	2-284047-1	2-1546231-1	2-1546122-1
22	111.76 [4.400]	2-284041-2	2-1546105-2	2-1546224-2	2-284047-2	2-1546231-2	2-1546122-2
23	116.84 [4.600]	2-284041-3	2-1546105-3	2-1546224-3	2-284047-3	2-1546231-3	2-1546122-3
24	121.92 [4.800]	2-284041-4	2-1546105-4	2-1546224-4	2-284047-4	2-1546231-4	2-1546122-4
25	127.00 [5.000]	2-284041-5	2-1546105-5	2-1546224-5	2-284047-5	2-1546231-5	2-1546122-5

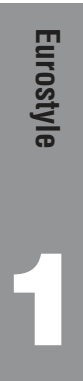

Note: All part numbers are RoHS Compliant.

Straight Plugs (Continued)

**Plug, Straight,
7.5 mm and 10.0 mm Centerline
Color – Green**

**UL Rating – 300 V, 15 A
12-30 AWG**

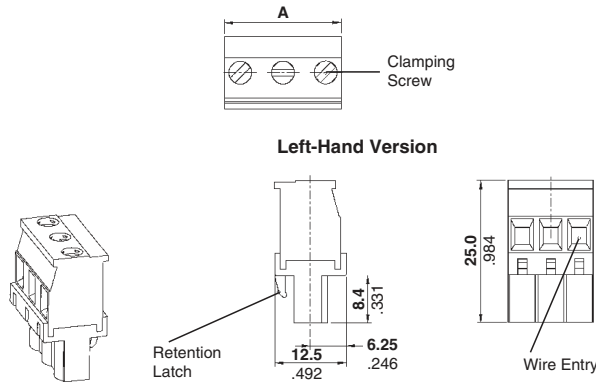

Suggested Screw Torque—7.0 in.-lbs.

No. of Positions	Dim. A	7.5 mm Centerline Part Numbers	
		Wire Entry	
		Left-Hand	Right-Hand
2	13.0 [.512]	284042-2	
3	20.5 [.807]	284042-3	
4	28.0 [1.102]	284042-4	
5	35.5 [1.398]	284042-5	
6	43.0 [1.693]	284042-6	
7	50.5 [1.988]	284042-7	
8	58.0 [2.283]	284042-8	
9	65.5 [2.579]	284042-9	
10	73.0 [2.874]	1-284042-0	
11	80.5 [3.169]	1-284042-1	
12	88.0 [3.465]	1-284042-2	

No. of Positions	Dim. A	10.0 mm Centerline Part Numbers	
		Wire Entry	
		Left-Hand	Right-Hand
2	15.0 [0.591]	284044-2	
3	25.0 [0.984]	284044-3	
4	35.0 [1.378]	284044-4	
5	45.0 [1.772]	284044-5	
6	55.0 [2.165]	284044-6	
7	65.0 [2.559]	284044-7	
8	75.0 [2.953]	284044-8	
9	85.0 [3.346]	284044-9	
10	95.0 [3.740]	1-284044-0	
11	105.0 [4.134]	1-284044-1	
12	115.0 [4.528]	1-284044-2	
13	125.0 [4.921]	1-284044-3	

**Plug, Straight,
7.62 mm and 10.16 mm Centerline**

**UL Rating – 300 V, 15 A
12-30 AWG**

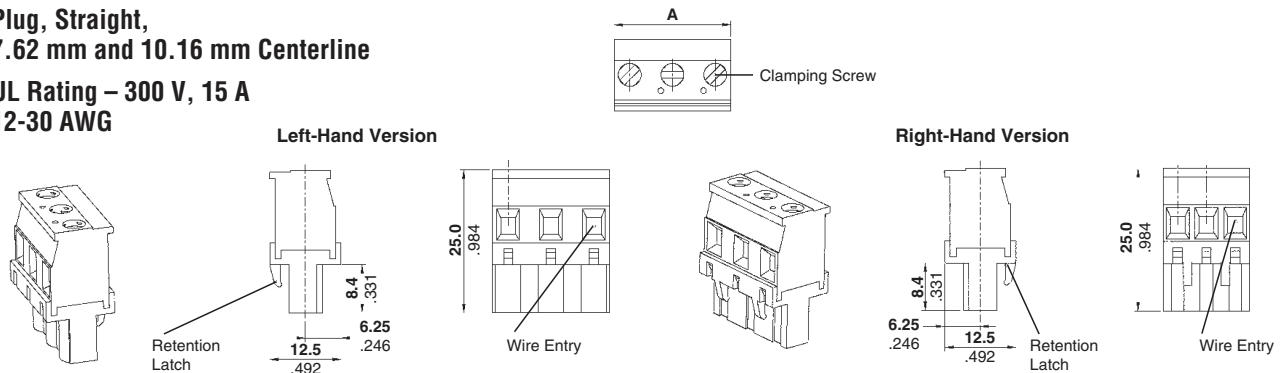

Suggested Screw Torque—7.0 in.-lbs.

No. of Positions	Dim. A	7.62 mm Centerline Part Numbers		
		Wire Entry		
		Left-Hand	Black	Right-Hand
2	13.24 [.521]	284043-2	1546935-2	284049-2
3	20.86 [.821]	284043-3	1546935-3	284049-3
4	28.48 [1.121]	284043-4	1546935-4	284049-4
5	36.10 [1.421]	284043-5	1546935-5	284049-5
6	43.72 [1.721]	284043-6	1546935-6	284049-6
7	51.34 [2.021]	284043-7	1546935-7	284049-7
8	58.96 [2.321]	284043-8	1546935-8	284049-8
9	66.58 [2.621]	284043-9	1546935-9	284049-9
10	74.20 [2.921]	1-284043-0	1-1546935-0	1-284049-0
11	81.82 [3.221]	1-284043-1	1-1546935-1	1-284049-1
12	89.44 [3.521]	1-284043-2	—	1-284049-2

No. of Positions	Dim. A	10.16 mm Centerline Part Numbers		
		Wire Entry		
		Left-Hand	Green	Right-Hand
2	15.24 [0.600]	284045-2	284051-2	1776538-2
3	25.40 [1.000]	284045-3	284051-3	1776538-3
4	35.56 [1.400]	284045-4	284051-4	1776538-4
5	45.72 [1.800]	284045-5	284051-5	1776538-5
6	55.88 [2.200]	284045-6	284051-6	1776538-6
7	66.04 [2.600]	284045-7	284051-7	1776538-7
8	76.20 [3.000]	284045-8	284051-8	1776538-8
9	86.36 [3.400]	284045-9	284051-9	1776538-9
10	96.52 [3.800]	1-284045-0	1-284051-0	1-1776538-0
11	106.68 [4.200]	1-284045-1	1-284051-1	1-1776538-1
12	116.84 [4.600]	1-284045-2	1-284051-2	1-1776538-2
13	127.00 [5.000]	1-284045-3	1-284051-3	—

Note: All part numbers are RoHS Compliant.

Unshrouded Straight Pin Headers

Unshrouded Straight Pin Headers, 5.0 mm Centerline Color – Black UL Rating – 300 V, 12 A

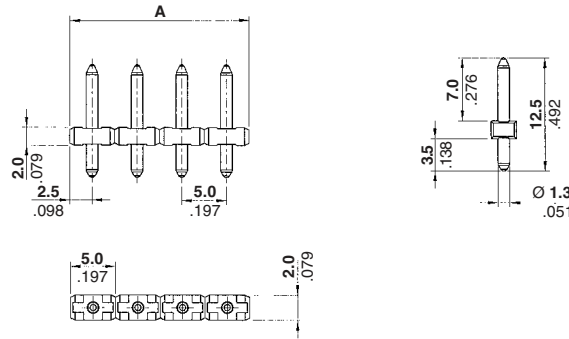
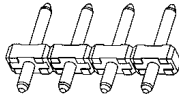

Recommended PC Board Layout

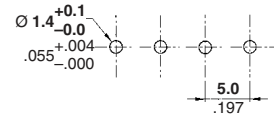

No. of Positions	Dim. A	Part Numbers*
2	10.0 [.394]	1546931-2
3	15.0 [.591]	1546931-3
4	20.0 [.787]	1546931-4
5	25.0 [.984]	1546931-5
6	30.0 [1.181]	1546931-6
7	35.0 [1.378]	1546931-7
8	40.0 [1.575]	1546931-8
9	45.0 [1.772]	1546931-9
10	50.0 [1.968]	1-1546931-0
11	55.0 [2.165]	1-1546931-1
12	60.0 [2.362]	1-1546931-2
13	65.0 [2.559]	1-1546931-3

No. of Positions	Dim. A	Part Numbers*
14	70.0 [2.756]	1-1546931-4
15	75.0 [2.953]	1-1546931-5
16	80.0 [3.150]	1-1546931-6
17	85.0 [3.346]	1-1546931-7
18	90.0 [3.543]	1-1546931-8
19	95.0 [3.740]	1-1546931-9
20	100.0 [3.937]	2-1546931-0
21	105.0 [4.134]	2-1546931-1
22	110.0 [4.331]	2-1546931-2
23	115.0 [4.528]	2-1546931-3
24	120.0 [4.724]	2-1546931-4
25	125.0 [4.921]	2-1546931-5

Note: Mate with Special Plug Connectors on pages 86 and 87.
*Wave solder process capable to 265°C [509°F] for 10 seconds.

Unshrouded Straight Pin Headers, 10.0 mm Centerline Color – Black UL Rating – 300 V, 12 A

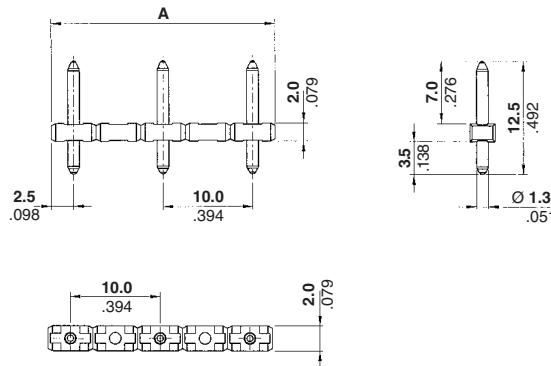
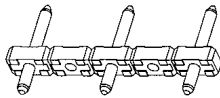

Recommended PC Board Layout

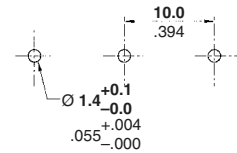

No. of Positions	Dim. A	Part Numbers*
2	15.0 [.591]	1546932-2
3	25.0 [.984]	1546932-3
4	35.0 [1.378]	1546932-4
5	45.0 [1.772]	1546932-5
6	55.0 [2.165]	1546932-6

Note: Mate with Special Plug Connectors on page 88.
*Wave solder process capable to 265°C [509°F] for 10 seconds.



Note: All part numbers are RoHS Compliant.

Special Plug Connectors

Special 90°/180° Plug Connectors, 5.0 mm Centerline Color – See chart.

UL Rating – 300 V, 12 A 14-30 AWG

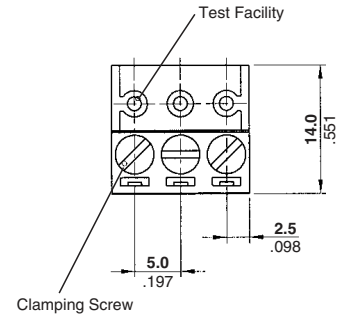
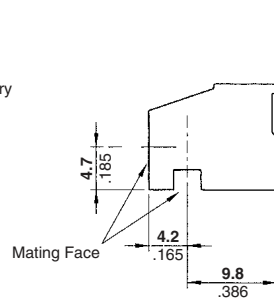
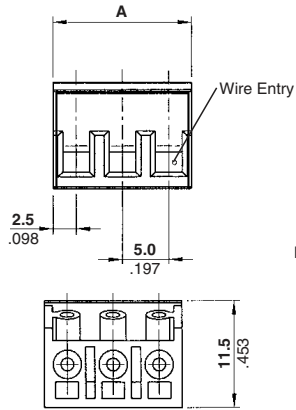
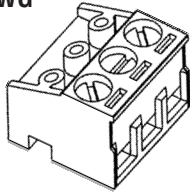

Suggested Screw Torque—6.0 in.-lbs.

No. of Positions	Dim. A	Part Numbers	
		Green	Black
2	10.0 [.394]	282830-2	1546018-2
3	15.0 [.591]	282830-3	1546018-3
4	20.0 [.787]	282830-4	1546018-4
5	25.0 [.984]	282830-5	1546018-5
6	30.0 [1.181]	282830-6	1546018-6
7	35.0 [1.378]	282830-7	1546018-7
8	40.0 [1.575]	282830-8	1546018-8
9	45.0 [1.772]	282830-9	1546018-9
10	50.0 [1.968]	1-282830-0	1-1546018-0
11	55.0 [2.165]	1-282830-1	1-1546018-1
12	60.0 [2.362]	1-282830-2	1-1546018-2
13	65.0 [2.559]	1-282830-4	1-1546018-3

Note: Mate only with 1546931 (black) pin headers.

No. of Positions	Dim. A	Part Numbers	
		Green	Black
14	70.0 [.591]	1-282830-5	1-1546018-4
15	75.0 [.787]	1-282830-6	1-1546018-5
16	80.0 [.984]	1-282830-7	1-1546018-6
17	85.0 [1.181]	1-282830-8	1-1546018-7
18	90.0 [1.378]	1-282830-9	1-1546018-8
19	95.0 [1.575]	2-282830-0	1-1546018-9
20	100.0 [1.772]	2-282830-1	2-1546018-0
21	105.0 [1.968]	2-282830-2	2-1546018-1
22	110.0 [2.165]	2-282830-3	2-1546018-2
23	115.0 [2.362]	2-282830-4	2-1546018-3
24	120.0 [2.362]	2-282830-5	2-1546018-4
25	125.0 [2.362]	2-282830-6	2-1546018-5

Special 90°/270° Plug Connectors, 5.0 mm Centerline Color – Gray

UL Rating – 300 V, 12 A 14-30 AWG

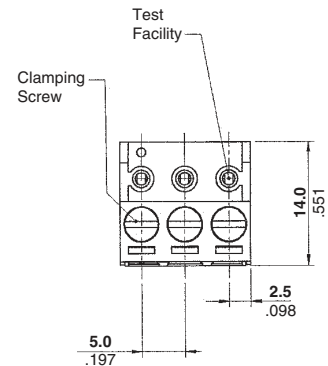
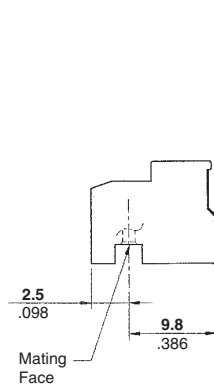
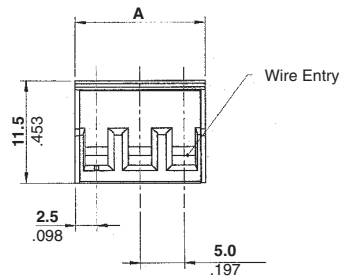
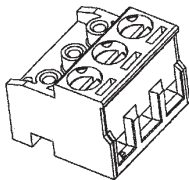

Suggested Screw Torque—6.0 in.-lbs.

No. of Positions	Dim. A	Part Numbers
2	10.0 [.394]	1546226-2
3	15.0 [.591]	1546226-3
4	20.0 [.787]	1546226-4
5	25.0 [.984]	1546226-5
6	30.0 [1.181]	1546226-6
7	35.0 [1.378]	1546226-7
8	40.0 [1.575]	1546226-8
9	45.0 [1.772]	1546226-9
10	50.0 [1.968]	1-1546226-0
11	55.0 [2.165]	1-1546226-1
12	60.0 [2.362]	1-1546226-2
13	65.0 [2.559]	1-1546226-3

Note: Mate only with 1546931 (black) pin headers.

No. of Positions	Dim. A	Part Numbers
14	70.0 [.591]	1-1546226-4
15	75.0 [.787]	1-1546226-5
16	80.0 [.984]	1-1546226-6
17	85.0 [1.181]	1-1546226-7
18	90.0 [1.378]	1-1546226-8
19	95.0 [1.575]	1-1546226-9
20	100.0 [1.772]	2-1546226-0
21	105.0 [1.968]	2-1546226-1
22	110.0 [2.165]	2-1546226-2
23	115.0 [2.362]	2-1546226-3
24	120.0 [2.362]	2-1546226-4
25	125.0 [2.362]	2-1546226-5

Note: All part numbers are RoHS Compliant.

Special Plug Connectors with Latch

Special 90°/270° Plug Connectors with Latch, 5.0 mm Centerline Color – Green

**UL Rating – 300 V, 12 A
14-30 AWG**

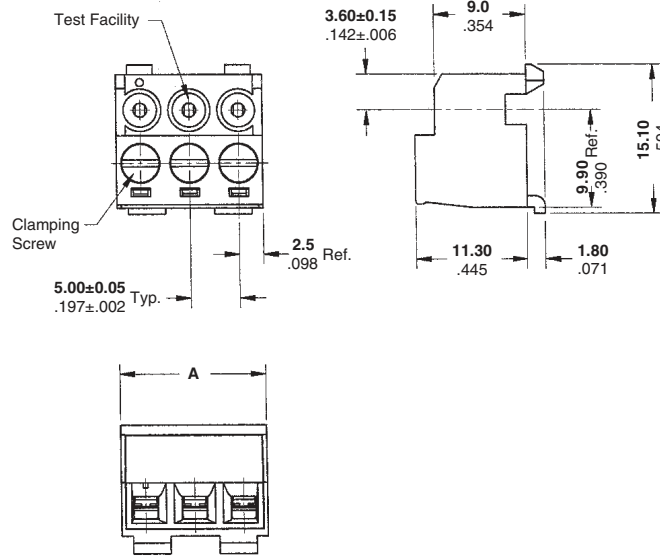
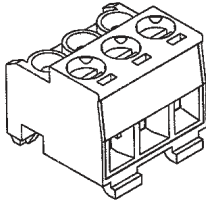

Suggested Screw Torque—6.0 in.-lbs.

No. of Positions	Dimension A	Part Numbers
2	10.0 [0.394]	1546173-2
3	15.0 [0.591]	1546173-3
4	20.0 [0.787]	1546173-4
5	25.0 [0.984]	1546173-5
6	30.0 [1.181]	1546173-6
7	35.0 [1.378]	1546173-7
8	40.0 [1.575]	1546173-8
9	45.0 [1.772]	1546173-9
10	50.0 [1.969]	1-1546173-0
11	55.0 [2.165]	1-1546173-1
12	60.0 [2.362]	1-1546173-2

Note: Mate only with 1546931 (black) pin headers.



Note: All part numbers are RoHS Compliant.

Special Plug Connectors

Special 90°/180° Plug Connectors, 10.0 mm Centerline Color – Green
UL Rating – 600 V, 12 A
14-30 AWG

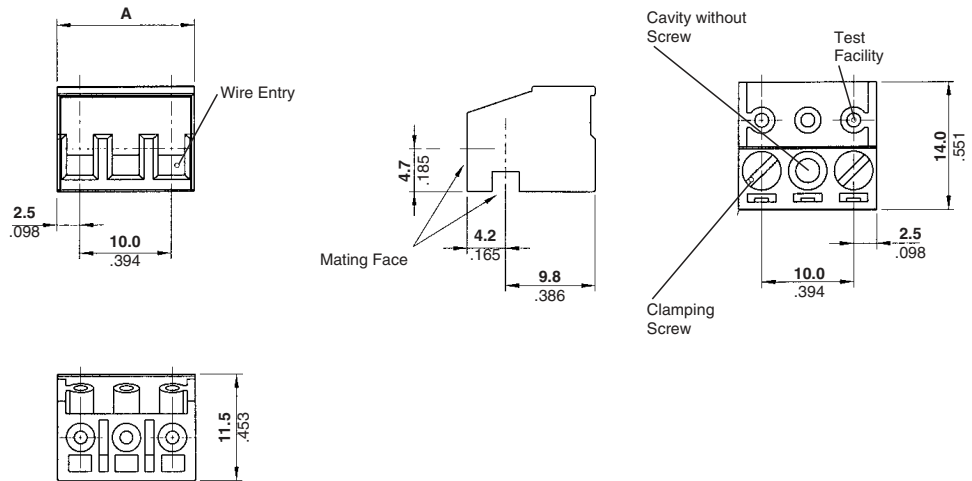
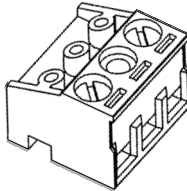

Suggested Screw Torque—6.0 in.-lbs.

No. of Positions	Dim. A	Part Numbers
2	15.0 [.591]	282831-2
3	25.0 [.984]	282831-3
4	35.0 [1.378]	282831-4
5	45.0 [1.772]	282831-5
6	55.0 [2.165]	282831-6

Note: Mate only with 1546932 pin headers.

Note: All part numbers are RoHS Compliant.

Flush-Mount Connectors

5 mm Pitch



B51C4U (universal mounting)

A DIM
5 mm: A = N x 5
N = # of Poles

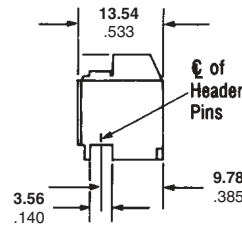
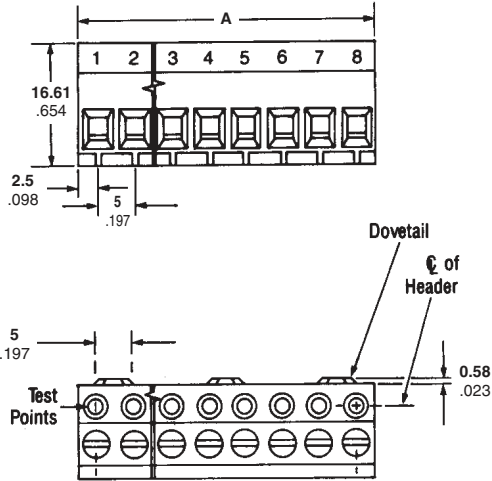

5 mm Flush-Mount Plug-In Connectors with Cage Clamp Series B51C4 (Mate with Series B71N4 Pin Headers)

Material & Finish

Housing Material—Polyamide, Type 6/6

Flammability—UL94V-0

Color—Black

Wire Entry Contact and Spring—Phosphor bronze, tin plated

Wire Cage—Hardened steel, zinc plated, yellow chromate treated

Screw—M2.5 x 6.2mm, steel, zinc plated, clear chromate treated

Mechanical Properties

Pitch (terminal spacing)—5mm

Wire Strip Length—6.4mm

Recommended Tightening Torque—0.5Nm [4.4 in-lbs]

Electrical Properties

Maximum Current—15A

Operating Voltage—300V (5mm)

Wire Range—12-30 AWG

Dielectric Withstand—2200V (5mm)

Environmental Properties

Operating Temperature Range—-60°C to +105°C [-76°F to +221°F]

No. of Positions	5mm Universal	
	Part Number	Catalog Number
2	1437426-1	B51C4U02T
3	1437426-3	B51C4U03T
4	1437426-9	B51C4U04T
5	1-1437426-3	B51C4U05T
6	1-1437426-6	B51C4U06T
7	2-1437426-0	B51C4U07T
8	2-1437426-5	B51C4U08T
9	2-1437426-8	B51C4U09T
10	3-1437426-2	B51C4U10T
11	3-1437426-6	B51C4U11T
12	3-1437426-9	B51C4U12T
13	4-1437426-6	B51C4U13T
14	4-1437426-9	B51C4U14T
15	5-1437426-1	B51C4U15T
16	5-1437426-3	B51C4U16T
17	—	B51C4U17T
18	5-1437426-6	B51C4U18T
19	—	B51C4U19T
20	5-1437426-7	B51C4U20T
21	—	B51C4U21T
22	5-1437426-8	B51C4U22T
23	—	B51C4U23T
24	5-1437426-9	B51C4U24T



Note: All part numbers are RoHS Compliant.

Flush-Mount Pin Headers

5 mm Pitch



5 mm Flush-Mount Pin Headers Series B71N4 (Mate with Series B51C4 Connectors)

Material & Finish

Housing Material—Liquid crystal polymer

Flammability—UL94V-0

Color—Black

Solder Pin—Phosphor bronze, tin plated

Mechanical Properties

Pitch (Pin Spacing)—5mm

Recommended PCB Hole Dia.—1.7mm

Electrical Properties

Maximum Current—15A

Operating Voltage—300V (5mm)

Environmental Properties

Operating Temperature Range—-30°C to +105°C [-22°F to 221°F] Tin contact system

(Vertical Solder Pins)

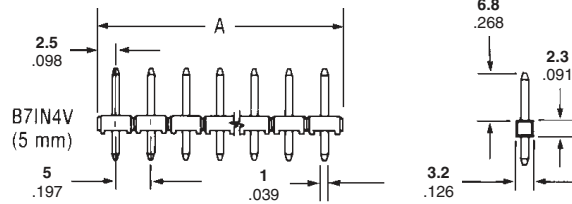

Series B51C4 Plug-in Connector

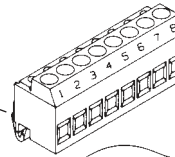

Series B71N4 Vertical Pin Header

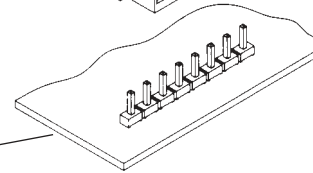

No. of Positions	Dimension A	Part Number	Catalog Number
2	10.00 [.394]	1776452-2	B71N4V02T
3	15.00 [.591]	1776452-3	B71N4V03T
4	15.00 [.591]	1776452-4	B71N4V04T
5	25.00 [.984]	1776452-5	B71N4V05T
6	30.00 [1.181]	1776452-6	B71N4V06T
7	35.00 [1.378]	1776452-7	B71N4V07T
8	40.00 [1.575]	1776452-8	B71N4V08T
9	45.00 [1.772]	1776452-9	B71N4V09T
10	50.00 [1.969]	1-1776452-0	B71N4V10T
11	55.00 [2.165]	1-1776452-1	B71N4V11T
12	60.00 [2.362]	1-1776452-2	B71N4V12T
13	65.00 [2.559]	1-1776452-3	B71N4V13T
14	70.00 [2.756]	1-1776452-4	B71N4V14T
15	75.00 [2.953]	1-1776452-5	B71N4V15T
16	80.00 [3.150]	1-1776452-6	B71N4V16T
17	85.00 [3.346]	1-1776452-7	B71N4V17T
18	90.00 [3.543]	1-1776452-8	B71N4V18T
19	—	—	B71N4V19T
20	100.00 [3.937]	2-1776452-0	B71N4V20T
21	—	—	B71N4V21T
22	110.00 [4.331]	2-1776452-2	B71N4V22T
23	—	—	B71N4V23T
24	120.00 [4.724]	2-1776452-4	B71N4V24T



LR28387

E63810

Flush-Mount Connectors

5.08 mm Pitch



B51C8U (universal mounting)

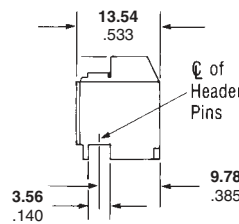
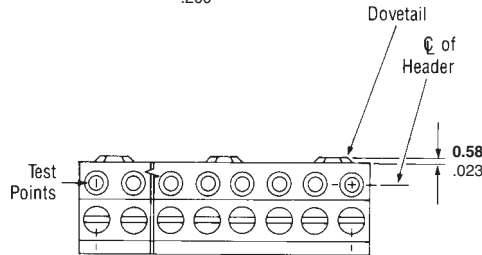
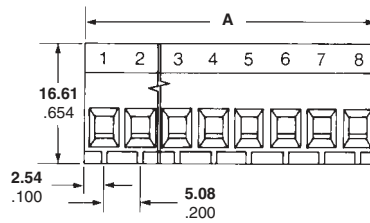

5.08 mm Flush-Mount Plug-In Connectors with Cage Clamp Series B51C8 (Mate with Series B71N8 Pin Headers)

Material & Finish

Housing Material—Polyamide, Type 6/6

Flammability—UL94V-0

Color—Blue

Wire Entry Contact and Spring—Phosphor bronze, tin plated

Wire Cage—Hardened steel, zinc plated, yellow chromate treated

Screw—M2.5 x 6.2mm, steel, zinc plated, clear chromate treated

Mechanical Properties

Pitch (terminal spacing)—5.08mm

Mounting—Universal (vertical & horizontal)

Wire Strip Length—6.4mm

Recommended Tightening Torque—0.5 Nm (4.4 in-lbs)

Electrical Properties

Maximum Current—15A

Operating Voltage—300V (5.08mm)

Wire Range—12-30 AWG

Dielectric Withstand—2200V (5.08mm)

Environmental Properties

Operating Temperature Range—-60°C to +105°C [-76°F to 221°F]

No. of Positions	Dim. A	Part Number	Catalog Number
2	10.16 [.400]	7-1437426-1	B51C8U02T
3	15.24 [.600]	7-1437426-2	B51C8U03T
4	20.32 [.800]	7-1437426-4	B51C8U04T
5	25.40 [1.000]	7-1437426-5	B51C8U05T
6	30.48 [1.200]	7-1437426-7	B51C8U06T
7	35.56 [1.400]	7-1437426-8	B51C8U07T
8	40.64 [1.600]	8-1437426-0	B51C8U08T
9	45.72 [1.800]	8-1437426-1	B51C8U09T
10	50.80 [2.000]	8-1437426-3	B51C8U10T
11	55.88 [2.200]	8-1437426-6	B51C8U11T
12	60.96 [2.400]	8-1437426-7	B51C8U12T
13	66.04 [2.600]	9-1437426-0	B51C8U13T
14	71.12 [2.800]	9-1437426-1	B51C8U14T
15	76.20 [3.000]	9-1437426-2	B51C8U15T

Note: All part numbers are RoHS Compliant.

Flush-Mount Pin Headers

5.08 mm Pitch



5.08 mm Flush-Mount Pin Headers Series B71N8 (Mates with Series B51C8 Connectors)

Material & Finish

Housing Material—Liquid crystal polymer

Flammability—UL94V-0

Color—Brown

Pin—Phosphor bronze, tin plated

Mechanical Properties

Pitch (pin spacing)—5.08mm

Recommended PCB Hole Dia.—1.7mm

Electrical Properties

Maximum Current—15A

Operating Voltage—300V (5mm)

Environmental Properties

Operating Temperature Range—
-30°C to +105°C [-22°F to 221°F] Tin contact system

(vertical solder pins)

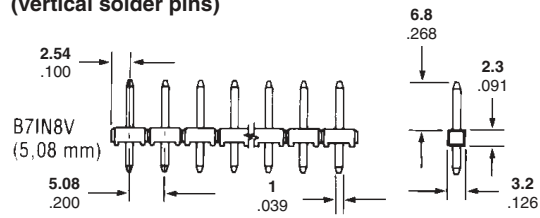

Series B51C8
Plug-in Connector

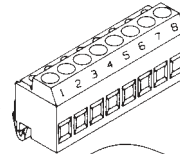

Series B71N8
Vertical Pin Header

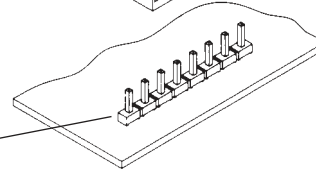

No. of Positions	Part Number	Catalog Number
2	1776453-2	B71N8V02T
3	1776453-3	B71N8V03T
4	1776453-4	B71N8V04T
5	1776453-5	B71N8V05T
6	1776453-6	B71N8V06T
7	1776453-7	B71N8V07T
8	1776453-8	B71N8V08T
9	1776453-9	B71N8V09T
10	1-1776453-0	B71N8V10T
11	1-1776453-1	B71N8V11T
12	1-1776453-2	B71N8V12T
13	—	B71N8V13T
14	1-1776453-4	B71N8V14T
15	—	B71N8V15T
16	1-1776453-6	B71N8V16T
17	1-1776453-7	B71N8V17T
18	1-1776453-8	B71N8V18T
19	—	B71N8V19T
20	2-1776453-0	B71N8V20T
21	—	B71N8V21T
22	2-1776453-2	B71N8V22T
23	—	B71N8V23T
24	2-1776453-4	B71N8V24T



Wire Protector Versions

Product Facts

- **Modular configuration designed with a dovetail and special detent to provide a more reliable attachment after combining smaller sizes to increase the number of available wire positions**
- **Accepts various wire ranges from 14-22 AWG**
- **Exceptional UL Flammability Classification. All are rated to a flammability classification of UL 94V-0. To achieve the UL94V-0 classification, all materials are tested and proven to be self-extinguishing**
- **UL Recognition File No. E28476**
- **CSA Certification File No. 209071**
- **Pitches Available**
 - **5.0 mm and 5.08 mm Low Profile**
 - **Side and top wire entry**
 - **3.5 mm Side Entry Only**
 - **5.00 mm**
 - **5.0 mm and 5.08 mm 45° wire entry**
- **Various position sizes available**
- **Ink marking available**
- **Other colors available upon request other than those listed in catalog**

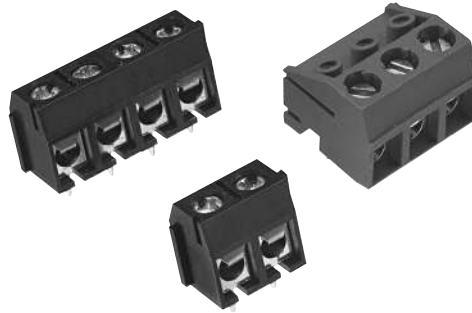

Has full wire guard protection so that the screw does not press directly on the wire. Offers "Lower Profile" terminal block than the cage clamp style. Designed for infrequent terminations.

The screw is able to accommodate both Slot head and Phillips style screwdrivers.

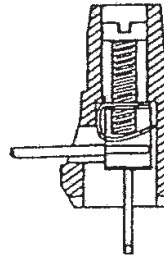

Open

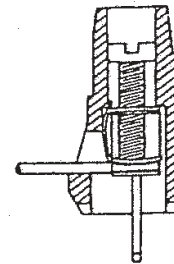

Closed

Note: All part numbers are RoHS Compliant.

PCB Mount, Straight, Top Wire Entry Connectors

Terminal Block PCB Mount
Top Wire Entry
w/Interlock
5.0 mm Pitch (LT)
Color – Blue
UL Rating – 250 V, 10 A
14-22 AWG

Suggested Screw Torque—
4.0 in.-lbs.

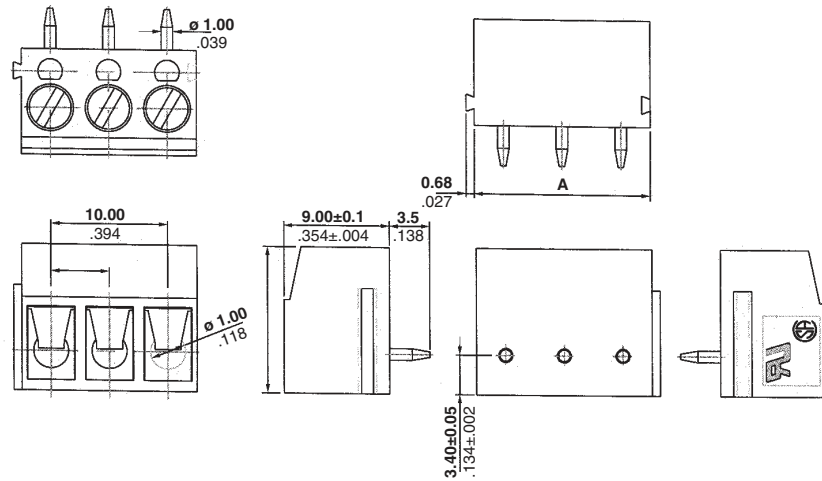

No. of Positions	Dim. A	Part Numbers
2	10.0 [0.394]	1776492-2
3	15.0 [0.591]	1776492-3
4	20.0 [0.787]	1776492-4
5	25.0 [0.984]	1776492-5
6	30.0 [1.181]	1776492-6
7	35.0 [1.378]	1776492-7
8	40.0 [1.575]	1776492-8
9	45.0 [1.772]	1776492-9
10	50.0 [1.968]	1-1776492-0
11	55.0 [2.165]	1-1776492-1
12	60.0 [2.362]	1-1776492-2
13	65.0 [2.559]	1-1776492-3
14	70.0 [2.756]	1-1776492-4
15	75.0 [2.953]	1-1776492-5
16	80.0 [3.150]	1-1776492-6
17	85.0 [3.346]	1-1776492-7
18	90.0 [3.543]	1-1776492-8
19	95.0 [3.740]	1-1776492-9
20	100.0 [3.937]	2-1776492-0
21	105.0 [4.134]	2-1776492-1
22	110.0 [4.331]	2-1776492-2
23	115.0 [4.528]	2-1776492-3
24	120.0 [4.724]	2-1776492-4

Wave solder process capable to 265°C [509°F] for 10 seconds

Note: All part numbers are RoHS Compliant.

PCB Mount, Straight, Top Wire Entry Connectors (Continued)

**Terminal Block PCB Mount
Top Wire Entry
Low Profile w/Interlock
5.0 mm Pitch (LT)
Color – See chart.**

**UL Rating – 250 V, 10 A
14-22 AWG**

**Suggested Screw Torque—
4.5 in.-lbs.**

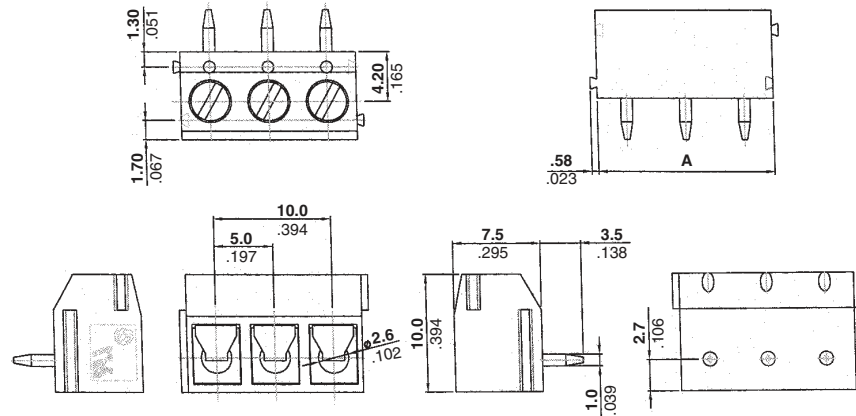

No. of Positions	Dim. A	Part No.	
		Blue	Green
2	10.0 [.394]	1776555-2	1776267-2
3	15.0 [.591]	1776555-3	1776267-3
4	20.0 [.787]	1776555-4	1776267-4
5	25.0 [.984]	1776555-5	1776267-5
6	30.0 [1.181]	1776555-6	1776267-6
7	35.0 [1.378]	1776555-7	1776267-7
8	40.0 [1.575]	1776555-8	1776267-8
9	45.0 [1.772]	1776555-9	1776267-9
10	50.0 [1.968]	1-1776555-0	1-1776267-0
11	55.0 [2.165]	1-1776555-1	1-1776267-1
12	60.0 [2.362]	1-1776555-2	1-1776267-2
13	65.0 [2.559]	1-1776555-3	1-1776267-3
14	70.0 [.591]	1-1776555-4	1-1776267-4
15	75.0 [.787]	1-1776555-5	1-1776267-5
16	80.0 [.984]	1-1776555-6	1-1776267-6
17	85.0 [1.181]	1-1776555-7	1-1776267-7
18	90.0 [1.378]	1-1776555-8	1-1776267-8
19	95.0 [1.575]	1-1776555-9	1-1776267-9
20	100.0 [1.772]	2-1776555-0	2-1776267-0
21	105.0 [1.968]	2-1776555-1	2-1776267-1
22	110.0 [2.165]	2-1776555-2	2-1776267-2
23	115.0 [2.362]	2-1776555-3	2-1776267-3
24	120.0 [2.362]	2-1776555-4	2-1776267-4

Wave solder process capable to 265°C [509°F] for 10 seconds



PCB Mount, Straight, Side Wire Entry Connectors

**Terminal Block PCB Mount
Side Wire Entry
w/Interlock
3.5 mm Pitch (LT)
Color – Blue**

**UL Rating – 250 V, 7 A
18-26 AWG**

**Suggested Screw Torque—
2.5 in.-lbs.**

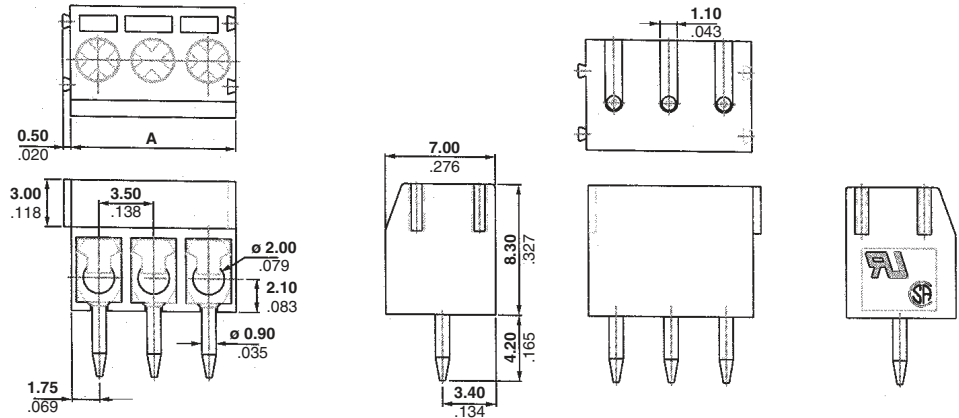

No. of Positions	Dim. A	Part Numbers
2	7.00 [.276]	1776275-2
3	10.50 [.413]	1776275-3
4	14.00 [.551]	1776275-4
5	17.50 [.689]	1776275-5
6	21.00 [.827]	1776275-6
7	24.50 [.965]	1776275-7
8	28.00 [1.102]	1776275-8
9	31.50 [1.240]	1776275-9
10	35.00 [1.378]	1-1776275-0
11	38.50 [1.516]	1-1776275-1
12	42.00 [1.654]	1-1776275-2
13	45.50 [1.791]	1-1776275-3
14	49.00 [1.929]	1-1776275-4
15	52.50 [2.067]	1-1776275-5
16	54.00 [2.126]	1-1776275-6
17	57.50 [2.264]	1-1776275-7
18	61.00 [2.402]	1-1776275-8
19	64.50 [2.539]	1-1776275-9
20	68.00 [2.677]	2-1776275-0
21	71.50 [2.815]	2-1776275-1
22	75.00 [2.953]	2-1776275-2
23	78.50 [3.091]	2-1776275-3
24	82.00 [3.228]	2-1776275-4

Wave solder process capable to 265°C [509°F] for 10 seconds

Note: All part numbers are RoHS Compliant.

PCB Mount, Straight, Side Wire Entry Connectors (Continued)

**Terminal Block PCB Mount
Side Wire Entry
Low Profile w/Interlock
5.0 mm Pitch (LT)**

**UL Rating – 250 V, 10 A
14-22 AWG**

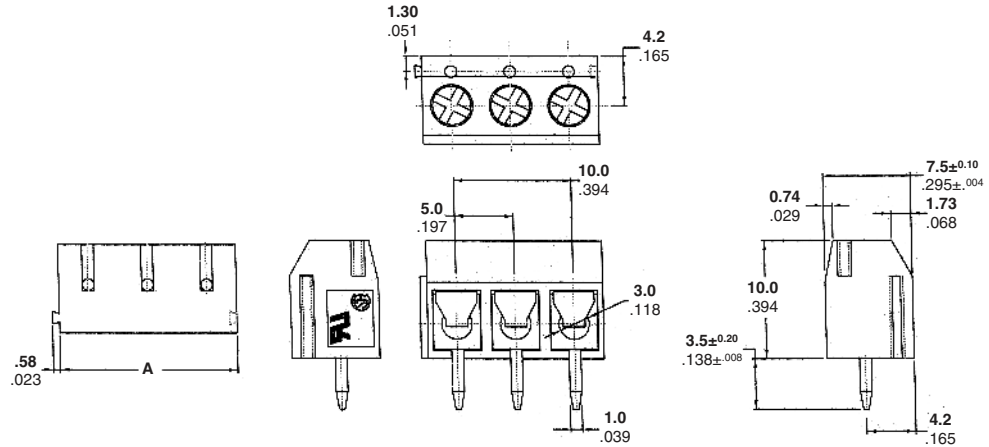

**Suggested Screw Torque—
4.5 in.-lbs.**

No. of Positions	Dim. A	Part Numbers			
		Blue	Green	Gray	Black
2	10.0 [.394]	1776244-2	1776266-2	1776504-2	1776269-2
3	15.0 [.591]	1776244-3	1776266-3	1776504-3	1776269-3
4	20.0 [.787]	1776244-4	1776266-4	1776504-4	1776269-4
5	25.0 [.984]	1776244-5	1776266-5	1776504-5	1776269-5
6	30.0 [1.181]	1776244-6	1776266-6	1776504-6	1776269-6
7	35.0 [1.378]	1776244-7	1776266-7	1776504-7	1776269-7
8	40.0 [1.575]	1776244-8	1776266-8	1776504-8	1776269-8
9	45.0 [1.772]	1776244-9	1776266-9	1776504-9	1776269-9
10	50.0 [1.968]	1-1776244-0	1-1776266-0	1-1776504-0	1-1776269-0
11	55.0 [2.165]	1-1776244-1	1-1776266-1	1-1776504-1	1-1776269-1
12	60.0 [2.362]	1-1776244-2	1-1776266-2	1-1776504-2	1-1776269-2
13	65.0 [2.559]	1-1776244-3	1-1776266-3	1-1776504-3	1-1776269-3
14	70.0 [.591]	1-1776244-4	1-1776266-4	1-1776504-4	1-1776269-4
15	75.0 [.787]	1-1776244-5	1-1776266-5	1-1776504-5	1-1776269-5
16	80.0 [.984]	1-1776244-6	1-1776266-6	1-1776504-6	1-1776269-6
17	85.0 [1.181]	1-1776244-7	1-1776266-7	1-1776504-7	1-1776269-7
18	90.0 [1.378]	1-1776244-8	1-1776266-8	1-1776504-8	1-1776269-8
19	95.0 [1.575]	1-1776244-9	1-1776266-9	1-1776504-9	1-1776269-9
20	100.0 [1.772]	2-1776244-0	2-1776266-0	2-1776504-0	2-1776269-0
21	105.0 [1.968]	2-1776244-1	2-1776266-1	2-1776504-1	2-1776269-1
22	110.0 [2.165]	2-1776244-2	2-1776266-2	2-1776504-2	2-1776269-2
23	115.0 [2.362]	2-1776244-3	2-1776266-3	2-1776504-3	2-1776269-3
24	120.0 [2.362]	2-1776244-4	2-1776266-4	2-1776504-4	2-1776269-4

Wave solder process capable to 265°C [509°F] for 10 seconds



PCB Mount, Straight, Side Wire Entry Connectors (Continued)

Terminal Block PCB Mount
Side Wire Entry
w/Interlock
5.00 mm Pitch (LT)
Color – Blue
UL Rating – 250 V, 10 A
14-22 AWG

Suggested Screw Torque—
4.5 in.-lbs.

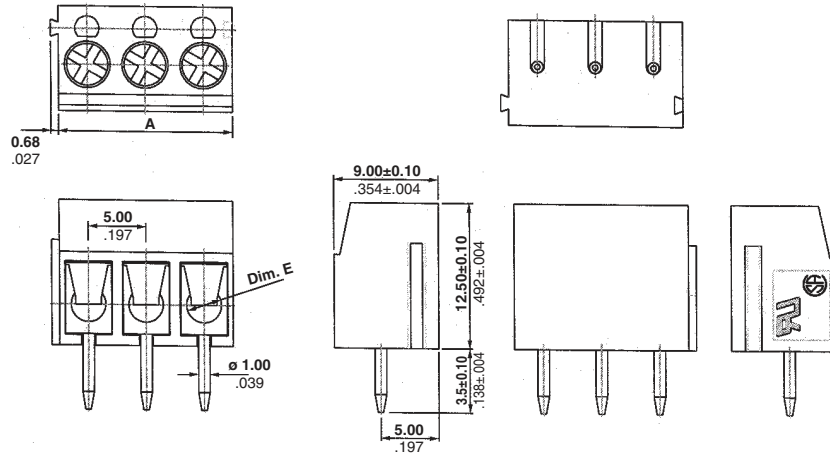

No. of Positions	Dim. A	Part Numbers
2	10.00 [.394]	1776491-2
3	15.00 [.591]	1776491-3
4	20.00 [.787]	1776491-4
5	25.00 [.984]	1776491-5
6	30.00 [1.181]	1776491-6
7	35.00 [1.378]	1776491-7
8	40.00 [1.575]	1776491-8
9	45.00 [1.772]	1776491-9
10	50.00 [1.969]	1-1776491-0
11	55.00 [2.165]	1-1776491-1
12	60.00 [2.362]	1-1776491-2
13	65.00 [2.559]	1-1776491-3
14	70.00 [2.756]	1-1776491-4
15	75.00 [2.953]	1-1776491-5
16	80.00 [3.150]	1-1776491-6
17	85.00 [3.346]	1-1776491-7
18	90.00 [3.543]	1-1776491-8
19	95.00 [3.740]	1-1776491-9
20	100.00 [3.937]	2-1776491-0
21	105.00 [4.134]	2-1776491-1
22	110.00 [4.331]	2-1776491-2
23	115.00 [4.525]	2-1776491-3
24	120.00 [4.724]	2-1776491-4

Wave solder process capable to 265°C [509°F] for 10 seconds

45° Wire Inlet Connectors

Terminal Block
45° Wire Inlet w/Interlock
5.00 mm Pitch (LT)
Color – Blue
UL Rating – 250 V, 10 A
14-22 AWG

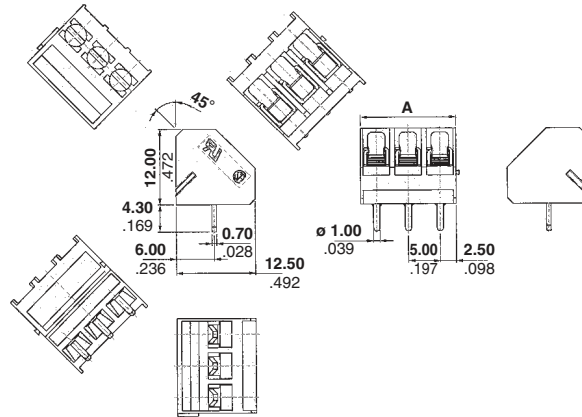

Suggested Screw Torque—
4.0 in.-lbs.

No. of Positions	Dim. A	Part Numbers
2	10.00 [.394]	1776252-2
3	15.00 [.591]	1776252-3
4	20.00 [.787]	1776252-4
5	25.00 [.984]	1776252-5
6	30.00 [1.181]	1776252-6
7	35.00 [1.378]	1776252-7
8	40.00 [1.575]	1776252-8
9	45.00 [1.772]	1776252-9
10	50.00 [1.969]	1-1776252-0
11	55.00 [2.165]	1-1776252-1
12	60.00 [2.362]	1-1776252-2
13	65.00 [2.559]	1-1776252-3

No. of Positions	Dim. A	Part Numbers
14	70.00 [2.756]	1-1776252-4
15	75.00 [2.953]	1-1776252-5
16	80.00 [3.150]	1-1776252-6
17	85.00 [3.346]	1-1776252-7
18	90.00 [3.543]	1-1776252-8
19	95.00 [3.740]	1-1776252-9
20	100.00 [3.937]	2-1776252-0
21	105.00 [4.134]	2-1776252-1
22	110.00 [4.331]	2-1776252-2
23	115.00 [4.528]	2-1776252-3
24	120.00 [4.724]	2-1776252-4

Wave solder process capable to 265°C [509°F] for 10 seconds

Terminal Block
45° Wire Inlet w/Interlock
5.08 mm Pitch (LT)
Color – Blue
UL Rating – 250 V, 10 A
14-22 AWG

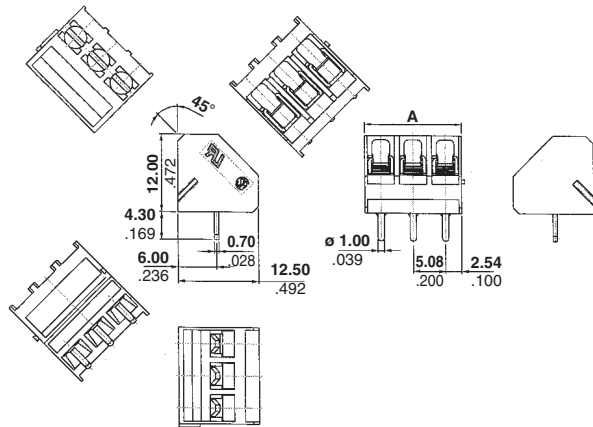

Suggested Screw Torque—
4.0 in.-lbs.

No. of Positions	Dim. A	Part Numbers
2	10.16 [.400]	1776258-2
3	15.24 [.600]	1776258-3
4	20.32 [.800]	1776258-4
5	25.40 [1.000]	1776258-5
6	30.48 [1.200]	1776258-6
7	35.56 [1.400]	1776258-7
8	40.64 [1.600]	1776258-8
9	45.72 [1.800]	1776258-9
10	50.80 [2.000]	1-1776258-0
11	55.88 [2.200]	1-1776258-1
12	60.96 [2.400]	1-1776258-2
13	66.04 [2.600]	1-1776258-3

No. of Positions	Dim. A	Part Numbers
14	71.12 [2.800]	1-1776258-4
15	76.20 [3.000]	1-1776258-5
16	81.28 [3.200]	1-1776258-6
17	86.36 [3.400]	1-1776258-7
18	91.44 [3.600]	1-1776258-8
19	96.52 [3.800]	1-1776258-9
20	101.60 [4.000]	2-1776258-0
21	106.68 [4.200]	2-1776258-1
22	111.76 [4.400]	2-1776258-2
23	116.84 [4.600]	2-1776258-3
24	121.92 [4.800]	2-1776258-4

Wave solder process capable to 265°C [509°F] for 10 seconds

Note: All part numbers are RoHS Compliant.

Plug, Flush Mount

**Plug
Flush Mount
5.00 mm Pitch
Color – See chart.
UL Rating – 250/300 V, 10 A
14-22 AWG**

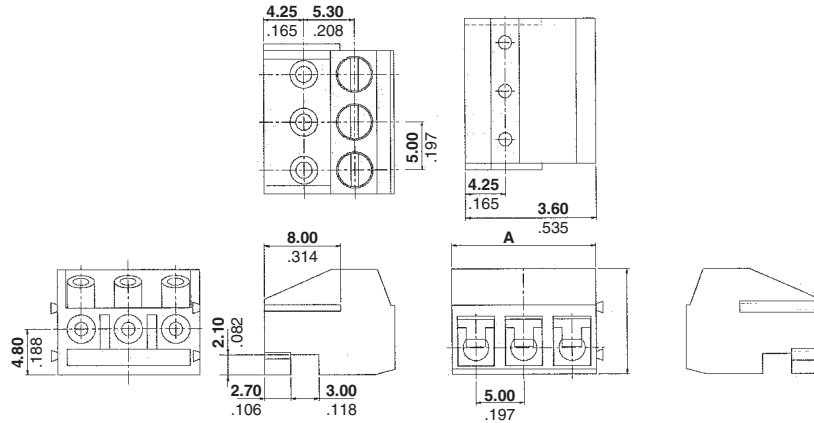

Suggested Screw Torque—
4.5 in.-lbs.

No. of Positions	Dim. A	Part No.	
		Black	Blue
2	10.00 [.394]	1776280-2	1776263-2
3	15.00 [.591]	1776280-3	1776263-3
4	20.00 [.787]	1776280-4	1776263-4
5	25.00 [.984]	1776280-5	1776263-5
6	30.00 [1.181]	1776280-6	1776263-6
7	35.00 [1.378]	1776280-7	1776263-7
8	40.00 [1.575]	1776280-8	1776263-8
9	45.00 [1.772]	1776280-9	1776263-9
10	50.00 [1.969]	1-1776280-0	1-1776263-0
11	55.00 [2.165]	1-1776280-1	1-1776263-1
12	60.00 [2.362]	1-1776280-2	1-1776263-2
13	65.00 [2.559]	1-1776280-3	1-1776263-3

No. of Positions	Dim. A	Part No.	
		Black	Blue
14	70.00 [2.756]	1-1776280-4	1-1776263-4
15	75.00 [2.953]	1-1776280-5	1-1776263-5
16	80.00 [3.150]	1-1776280-6	1-1776263-6
17	85.00 [3.346]	1-1776280-7	1-1776263-7
18	90.00 [3.543]	1-1776280-8	1-1776263-8
19	95.00 [3.740]	1-1776280-9	1-1776263-9
20	100.00 [3.937]	2-1776280-0	2-1776263-0
21	105.00 [4.134]	2-1776280-1	2-1776263-1
22	110.00 [4.331]	2-1776280-2	2-1776263-2
23	115.00 [4.528]	2-1776280-3	2-1776263-3
24	120.00 [4.724]	2-1776280-4	2-1776263-4

Header, Straight Mount

**Header
Straight Mount,
Unshrouded
5.00 mm Pitch
Color – Blue
UL Rating – 250/300 V, 10 A**

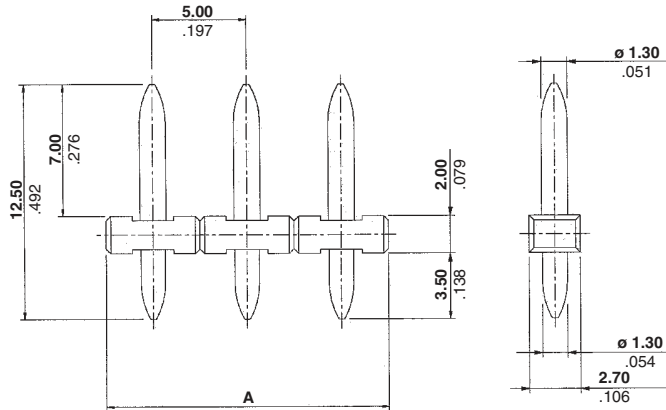

No. of Positions	Dim. A	Part Numbers
2	10.00 [.394]	1776489-2
3	15.00 [.591]	1776489-3
4	20.00 [.787]	1776489-4
5	25.00 [.984]	1776489-5
6	30.00 [1.181]	1776489-6
7	35.00 [1.378]	1776489-7
8	40.00 [1.575]	1776489-8
9	45.00 [1.772]	1776489-9
10	50.00 [1.969]	1-1776489-0
11	55.00 [2.165]	1-1776489-1
12	60.00 [2.362]	1-1776489-2
13	65.00 [2.559]	1-1776489-3

No. of Positions	Dim. A	Part Numbers
14	70.00 [2.756]	1-1776489-4
15	75.00 [2.953]	1-1776489-5
16	80.00 [3.150]	1-1776489-6
17	85.00 [3.346]	1-1776489-7
18	90.00 [3.543]	1-1776489-8
19	95.00 [3.740]	1-1776489-9
20	100.00 [3.937]	2-1776489-0
21	105.00 [4.134]	2-1776489-1
22	110.00 [4.331]	2-1776489-2
23	115.00 [4.528]	2-1776489-3
24	120.00 [4.724]	2-1776489-4

Wave solder process capable to 265°C [509°F] for 10 seconds

Note: All part numbers are RoHS Compliant.

Wire Trap

2.5 mm Pitch

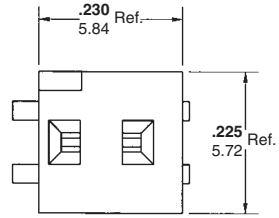
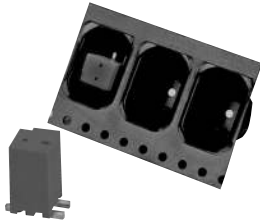

2.5 mm Surface Mount, Technology with Wire Trap, Series SMC

Material & Finish

Housing Material—Polyphenylene Sulfide (PPS)

Flammability—UL94V-0

Color—Black

Contact—Phosphor bronze, tin plated over nickel

Mechanical Properties

Pitch (terminal spacing)—2.5mm [.098]

Wire Strip Length—5.5mm min, 7.11mm max. [0.22" min, 0.28" max]

Max. Wire Insulation Diameter—1.7mm [.067]

Packaging—Tape and reel and loose piece

Electrical Properties

Maximum Current—3A

Operating Voltage—250V

Wire Range—24 AWG, stranded tin

Dielectric Withstand—1500 VAC

Environmental Properties

Max. Operating Temperature—105°C [221°F]

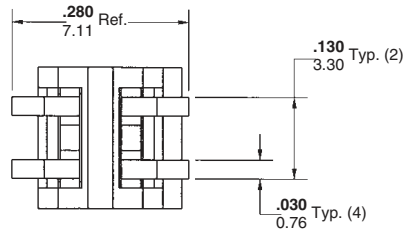
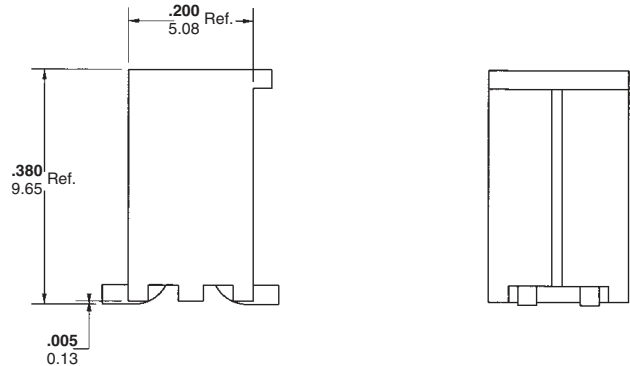

Surface Mount with Wire Trap

Product Facts

- n Available in 2.5 mm pitch
- n Accepts 24 AWG stranded tin
- n 2 position Connector
- n Current capability: 3 A
- n 250 V
- n Packaging: Tape and Reel and Loose Piece (25 pcs/bag)

Description	No. of Positions	Part Number	Catalog Number
Tape & Reel, 500 pieces	2	1776226-1	SMC2402
25 pieces	2	1776227-1	SM2V02

Note: All part numbers are RoHS Compliant.

PIVOT BLOCK 3.5 mm Plugs

Product Facts

- 3.5 mm [.138] centerline IDC plug
- Alternative to screw clamp plugs
- Two-piece pluggable terminal block system
- Mates with 3.5 mm horizontal and vertical terminal block headers on pages 45, 47, 49 and 58
- Proven pivot wire termination
- Multi-position connector, IDC termination and tactile feel when terminated
- No wire stripping required
- Flanged version available
- Designs available to terminate solid and stranded wires: 22-24 AWG (2-16 positions)
- Wire stuffer allows visual inspection of wire termination
- Screwdriver required to open wire stuffer

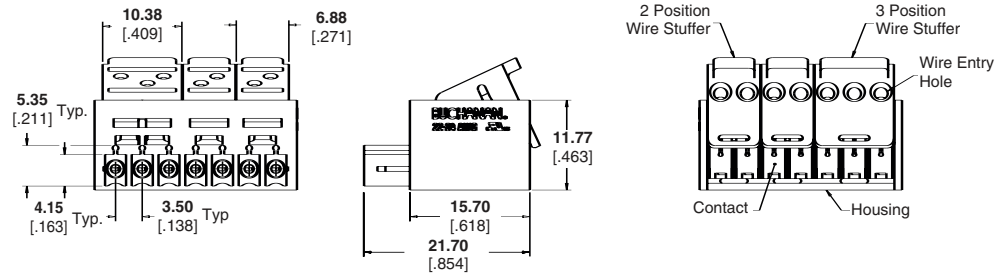
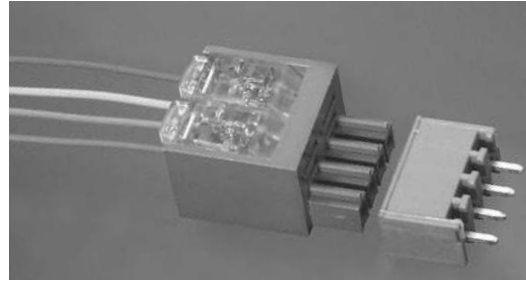

Material and Finish

Wire Stuffer—Polycarbonate
Housing—PBT Polyester, Green (standard color), blue also available
Contact—Phosphor Bronze
Plating—Tin over Nickel

Performance Characteristics

Mechanical Properties

10 cycles min. durability wire termination
 15 lbs. closing force max. (2 position)
 10 lbs. opening force max. (2 position)
 Screws for mounting flange M2.5 fixing screw

Electrical Properties

Maximum current 5A (22-24 AWG)
 Operating voltage 250 V
 Dielectric withstanding 1500 VAC

Technical Documents

Product Specification:
 108-1981

Application Specification:
 114-13037

No. of Positions	Description	22-24 AWG	
		Part Number Blue	Part Number Green
2	IDC T/B	1776279-2	1776282-2
	IDC T/B with Screw Flange	1776281-2	1776283-2
3	IDC T/B	1776279-3	1776282-3
	IDC T/B with Screw Flange	1776281-3	1776283-3
4	IDC T/B	1776279-4	1776282-4
	IDC T/B with Screw Flange	1776281-4	1776283-4
5	IDC T/B	1776279-5	1776282-5
	IDC T/B with Screw Flange	1776281-5	1776283-5
6	IDC T/B	1776279-6	1776282-6
	IDC T/B with Screw Flange	1776281-6	1776283-6
7	IDC T/B	1776279-7	1776282-7
	IDC T/B with Screw Flange	1776281-7	1776283-7
8	IDC T/B	1776279-8	1776282-8
	IDC T/B with Screw Flange	1776281-8	1776283-8
9	IDC T/B	1776279-9	1776282-9
	IDC T/B with Screw Flange	1776281-9	1776283-9
10	IDC T/B	1-1776279-0	1-1776282-0
	IDC T/B with Screw Flange	1-1776281-0	1-1776283-0
11	IDC T/B	1-1776279-1	1-1776282-1
	IDC T/B with Screw Flange	1-1776281-1	1-1776283-1
12	IDC T/B	1-1776279-2	1-1776282-2
	IDC T/B with Screw Flange	1-1776281-2	1-1776283-2
13	IDC T/B	1-1776279-3	1-1776282-3
	IDC T/B with Screw Flange	1-1776281-3	1-1776283-3
14	IDC T/B	1-1776279-4	1-1776282-4
	IDC T/B with Screw Flange	1-1776281-4	1-1776283-4
15	IDC T/B	1-1776279-5	1-1776282-5
	IDC T/B with Screw Flange	1-1776281-5	1-1776283-5
16	IDC T/B	1-1776279-6	1-1776282-6
	IDC T/B with Screw Flange	1-1776281-6	1-1776283-6

Note: All part numbers are RoHS Compliant.

Vertical Screwless Wire Connectors

Product Facts

- Contact design allows for retermination
- Terminates 16-18 AWG solid wire and 18 AWG bonded wire
- Through-hole solder mount with kinked legs for PCB retention

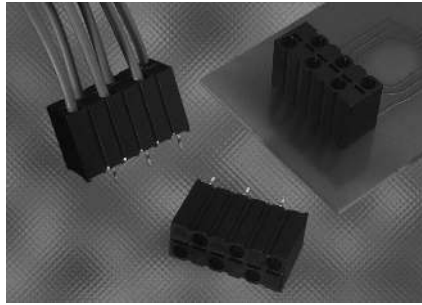

Material and Finish

Housing—UL94V-0 rated PBT
Contact—Phosphor Bronze
Contact Finish—Pre-tin over nickel underplate

Performance Characteristics

Mechanical Properties
 5 cycles min. durability wire termination
Wire Retention—5 lb. [22.25N]
Pitch—.138 [3.5 mm] staggered centerline

Electrical Properties

Maximum current 2A
 Operating voltage 600 V
 Dielectric withstanding 2200 VAC

Technical Documents

Product Specification:
 108-2059

Application Specification:
 114-13075

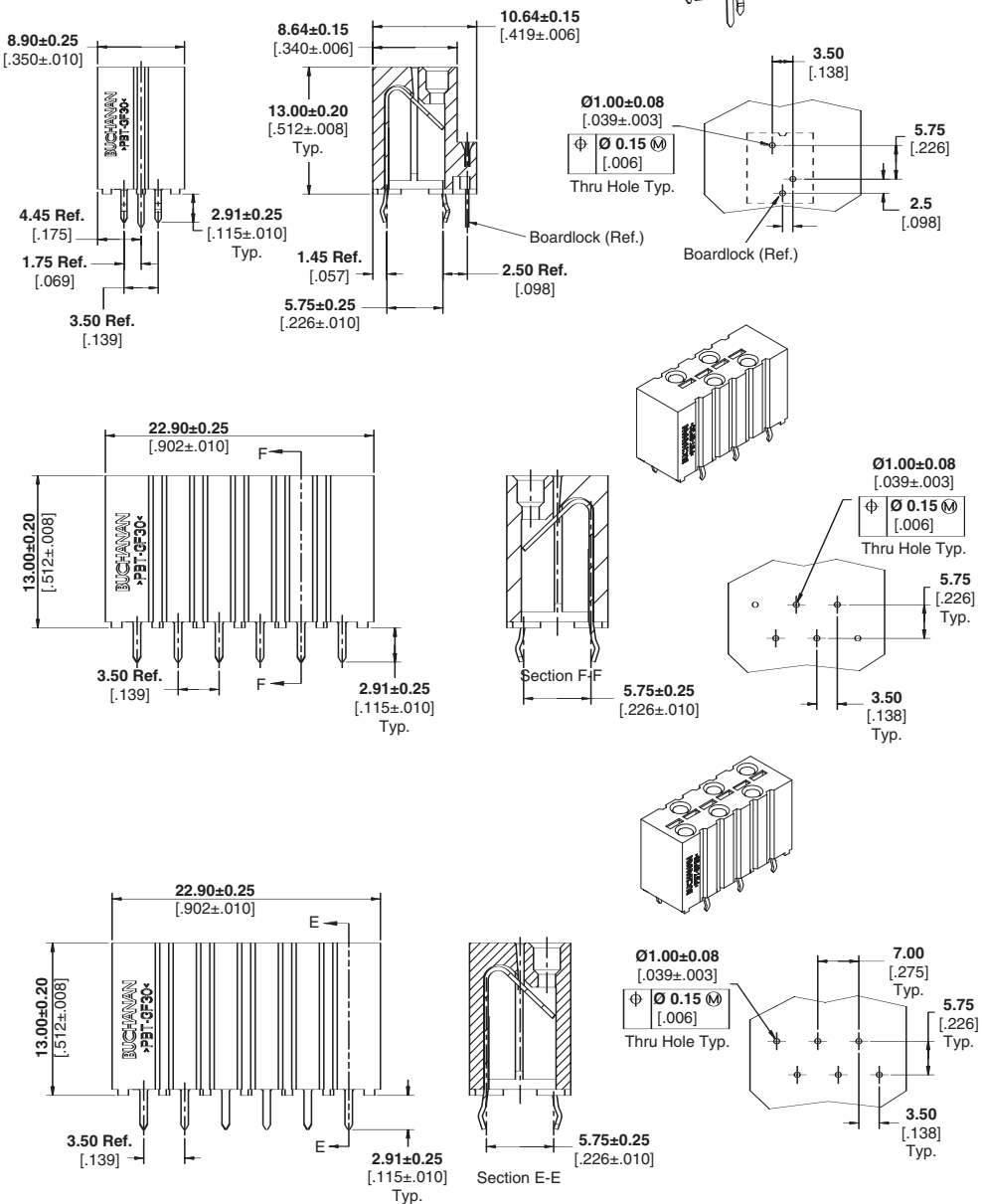



No. of Positions	Description	Part Numbers
2	W/Boardlock	1811957-1
4	—	1811444-1
6	—	1811398-1

Note: All part numbers are RoHS Compliant.

Screwless Terminal Blocks

Product Facts

- Available in 5.0 mm [.197] and 5.08 mm [.200] pitch sizes
- Wire range 14-22 AWG
- Current capability: 10 A (5.08 mm [.200] lever version)
- Vertical and right-angle wire insertion provides options to meet different application needs
- No special tool required, levers can be easily actuated with a finger or a screwdriver
- Screwless saves time when installing wires
- UL Recognition 
- CSA Certification 



5.0 mm and 5.08 mm Pitch (Pages 104, 105)

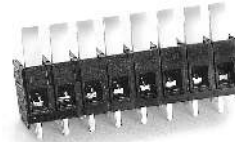

Series 2SV 5.08 mm Pitch (Below)

Screwless Terminal Blocks are suitable for both solid and stranded wires and offers a fast way to complete wire connections. The lever is fully integrated into the body of the terminal

block, which means no special tools are required.

The spring is made from stainless steel strip so that there is a strong connection.

5.08 mm Standard Connectors with Screwless Clamp Series 2SV

Material & Finish

Housing Material—Thermoplastic polyester

Flammability—UL94V-0

Color—Black

Clamping Terminal and Solder Pin— Acid-tin over copper alloy

Mechanical Properties

Pitch (terminal spacing)— 5.08mm [.200]

Recommended PCB Hole Dia.— 1.4mm [.055]

Electrical Properties

Maximum Current—10 A

Operating Voltage—150/300V (limited ratings)

Wire Range—18-22 AWG

Environmental Properties

Max. Operating Temperature— 130°C [266°F]

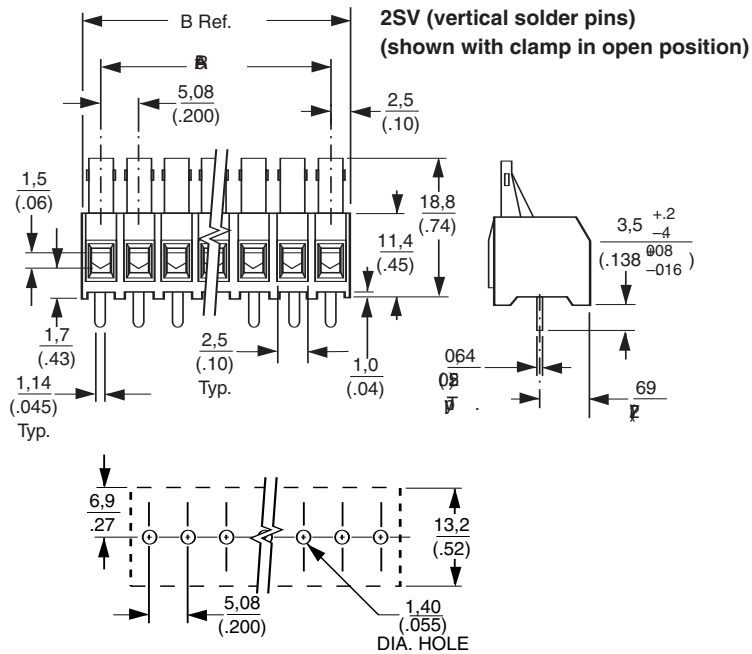

No. of Positions	Dimensions		Part Number	Catalog Number
	A	B		
2	0.2 [5.1]	0.4 [10.2]	1437671-1	2SV-02
3	0.4 [10.2]	0.6 [15.2]	1437671-4	2SV-03
4	0.6 [15.2]	0.8 [20.3]	1437671-6	2SV-04
5	0.8 [20.3]	1.0 [25.4]	1437671-7	2SV-05
6	1.0 [25.4]	1.2 [30.5]	1437671-9	2SV-06
7	1.2 [30.5]	1.4 [35.6]	1-1437671-0	2SV-07
8	1.4 [35.6]	1.6 [40.6]	1-1437671-1	2SV-08
9	1.6 [40.6]	1.8 [45.7]	1-1437671-2	2SV-09
10	1.8 [45.7]	2.0 [50.8]	1-1437671-3	2SV-10
11	2.0 [50.8]	2.2 [55.9]	1-1437671-4	2SV-11
12	2.2 [55.9]	2.4 [61.0]	1-1437671-5	2SV-12
13	2.4 [61.0]	2.6 [66.0]	1-1437671-6	2SV-13
14	2.6 [66.0]	2.8 [71.1]	1-1437671-9	2SV-14
15	2.8 [71.1]	3.0 [76.2]	2-1437671-0	2SV-15
16	3.0 [76.2]	3.2 [81.3]	2-1437671-1	2SV-16

Note: All part numbers are RoHS Compliant.

Screwless, Side Wire Entry Connectors

**Board Mount Screwless,
5.0 mm Pitch,
Side Wire Entry,
Terminal Block
Color – Green**

**UL Rating – 300 V, 10 A
14-22 AWG**

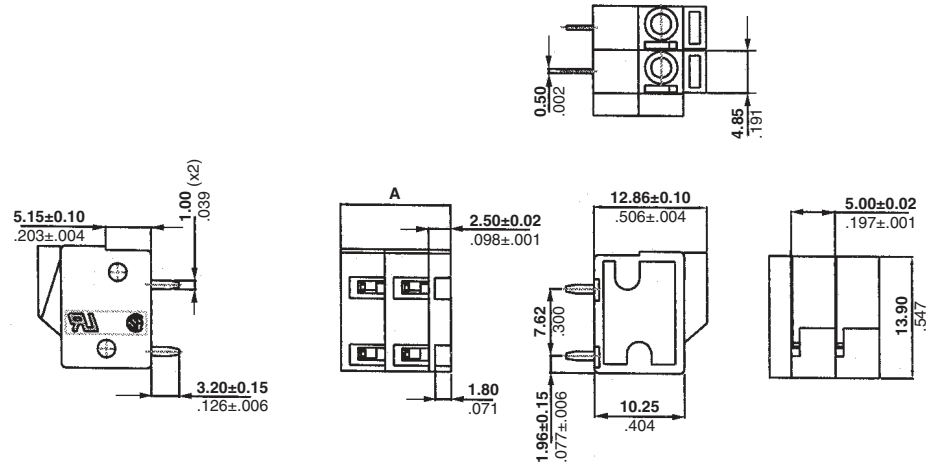

No. of Positions	Dim. A	Part Numbers
2	12.50 [.492]	1776261-2
3	17.50 [.689]	1776261-3
4	22.50 [.886]	1776261-4
5	27.50 [1.083]	1776261-5
6	32.50 [1.280]	1776261-6
7	37.50 [1.476]	1776261-7
8	42.50 [1.673]	1776261-8
9	47.50 [1.870]	1776261-9
10	52.20 [2.055]	1-1776261-0
11	57.50 [2.264]	1-1776261-1
12	62.50 [2.461]	1-1776261-2

Wave solder process capable to 265°C [509°F] for 10 seconds

**Board Mount Screwless,
5.08 mm Pitch,
Side Wire Entry,
Terminal Block
Color – Green**

**UL Rating – 300 V, 10 A
14-22 AWG**

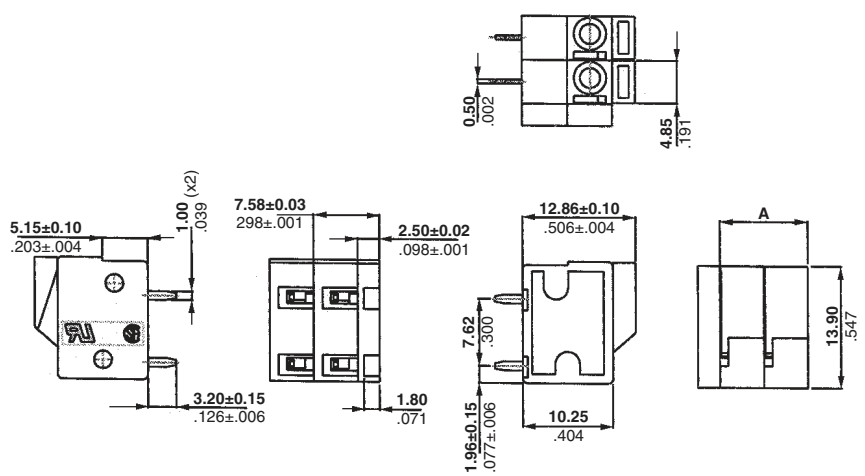

No. of Positions	Dim. A	Part Numbers
2	10.16 [.400]	1776262-2
3	15.24 [.600]	1776262-3
4	20.32 [.800]	1776262-4
5	25.40 [1.000]	1776262-5
6	30.48 [1.200]	1776262-6
7	35.56 [1.400]	1776262-7
8	40.64 [1.600]	1776262-8
9	45.72 [1.800]	1776262-9
10	50.80 [2.000]	1-1776262-0
11	55.88 [2.200]	1-1776262-1
12	60.96 [2.400]	1-1776262-2

Wave solder process capable to 265°C [509°F] for 10 seconds



Note: All part numbers are RoHS Compliant.

Screwless, Top Wire Entry Connectors

**Board Mount Screwless,
5.0 mm Pitch,
Top Wire Entry,
Terminal Block
Color – Green**

**UL Rating – 300 V, 10 A
14-22 AWG**

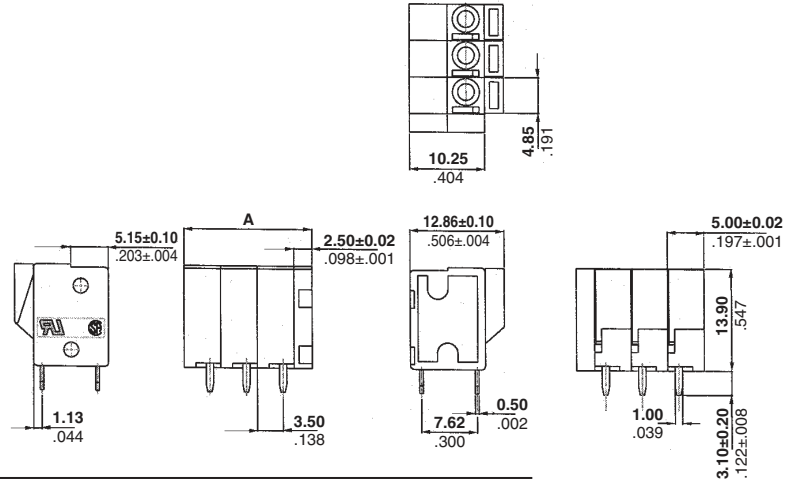

No. of Positions	Dim. A	Part Numbers
2	12.50 [.492]	1776259-2
3	17.50 [.689]	1776259-3
4	22.50 [.886]	1776259-4
5	27.50 [1.083]	1776259-5
6	32.50 [1.280]	1776259-6
7	37.50 [1.476]	1776259-7
8	42.50 [1.673]	1776259-8
9	47.50 [1.870]	1776259-9
10	52.20 [2.055]	1-1776259-0
11	57.50 [2.264]	1-1776259-1
12	62.50 [2.461]	1-1776259-2

Wave solder process capable to 265°C [509°F] for 10 seconds

**Board Mount Screwless,
5.08 mm Pitch,
Top Wire Entry,
Terminal Block
Color – Green**

**UL Rating – 300 V, 10 A
14-22 AWG**

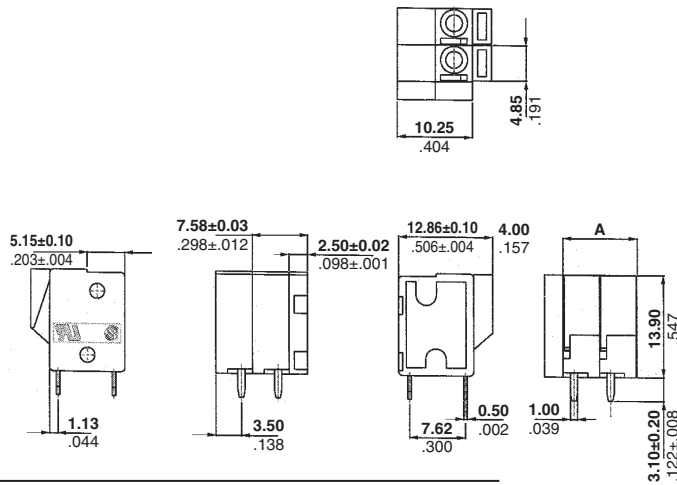

No. of Positions	Dim. A	Part Numbers
2	10.16 [.400]	1776260-2
3	15.24 [.600]	1776260-3
4	20.32 [.800]	1776260-4
5	25.40 [1.000]	1776260-5
6	30.48 [1.200]	1776260-6
7	35.56 [1.400]	1776260-7
8	40.64 [1.600]	1776260-8
9	45.72 [1.800]	1776260-9
10	50.80 [2.000]	1-1776260-0
11	55.88 [2.200]	1-1776260-1
12	60.96 [2.400]	1-1776260-2

Wave solder process capable to 265°C [509°F] for 10 seconds

Note: All part numbers are RoHS Compliant.

Labeling

Labeling

If you need to number Terminal Block connectors, Tyco Electronics makes available an easy-to-use numbering system based on adhesive labels with proper centerline.

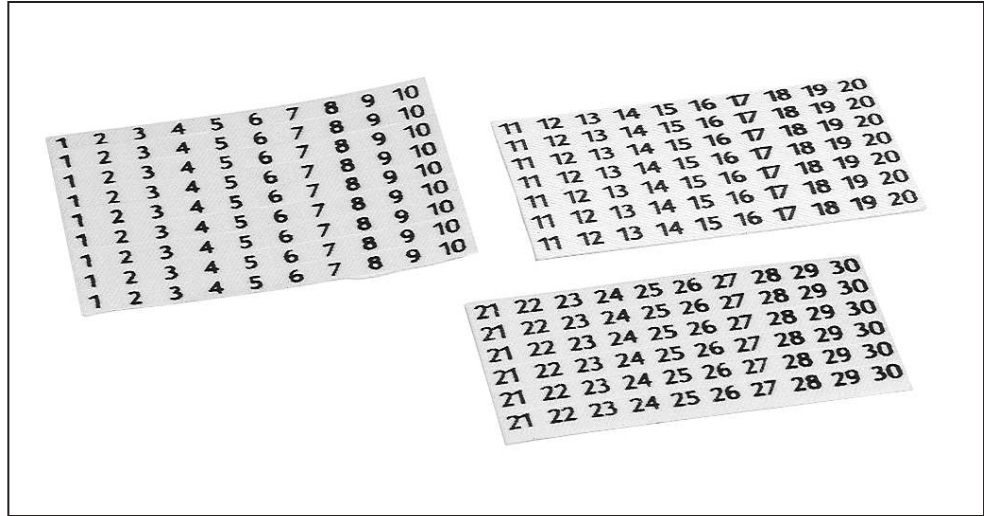

Centerline	Number of Positions	Numbering from...up to	Part Numbers
3.5 [.138]	10	1 ... 10	284627-1
3.5 [.138]	10	11 ... 20	284627-2
3.5 [.138]	10	21 ... 30	284627-3
3.5 [.138]	10	31 ... 40	284627-4
3.5 [.138]	10	41 ... 50	284627-5
3.5 [.138]	10	51 ... 60	284627-6
3.81 [.150]	10	1 ... 10	284628-1
3.81 [.150]	10	11 ... 20	284628-2
3.81 [.150]	10	21 ... 30	284628-3
3.81 [.150]	10	31 ... 40	284628-4
3.81 [.150]	10	41 ... 50	284628-5
3.81 [.150]	10	51 ... 60	284628-6
5.0-5.08 [.197-.200]	10	1 ... 10	282928-1
5.0-5.08 [.197-.200]	10	11 ... 20	282928-2
5.0-5.08 [.197-.200]	10	21 ... 30	282928-3
5.0-5.08 [.197-.200]	10	31 ... 40	282928-4
5.0-5.08 [.197-.200]	10	41 ... 50	282928-5
5.0-5.08 [.197-.200]	10	51 ... 60	282928-6
7.5-7.62 [.295-.300]	10	1 ... 10	282930-1
7.5-7.62 [.295-.300]	10	11 ... 20	282930-2
7.5-7.62 [.295-.300]	10	21 ... 30	282930-3
10.0-10.16 [.394-.400]	10	1 ... 10	282929-1
10.0-10.16 [.394-.400]	10	11 ... 20	282929-2
10.0-10.16 [.394-.400]	10	21 ... 30	282929-3

There are 12 adhesive labels per sheet.
Please ask for customized labeling.

Note: All part numbers are RoHS Compliant.

Accessories

Polarization Keys

Polarization keys help prevent wrong mating of two-piece Terminal Block connectors (not valid for special version).

Special keys allow you to differentiate counterparts, meeting OEMs' requirement for error-free interconnections.

Color – Red

For Plugs

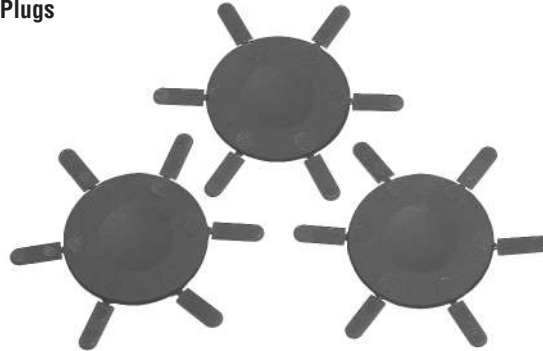

For Headers

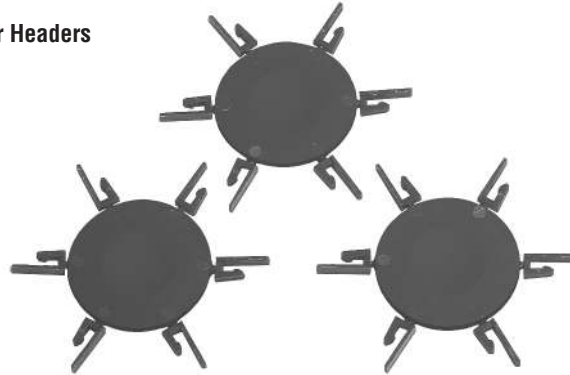

Application	Part Number*
Two-piece Terminal Block Plugs	282969-1
Two-piece Terminal Block Headers	282970-1
3.5, 3.81 mm [.138, .150] Plug	1546050-1
3.5, 3.81 mm [.138, .150] Header	1546051-1

*Comprised of 1 Circular Carrier with 6 Keys.

Screwdrivers

Screwdrivers are additional accessories to facilitate the application of Terminal Block stacking connectors.

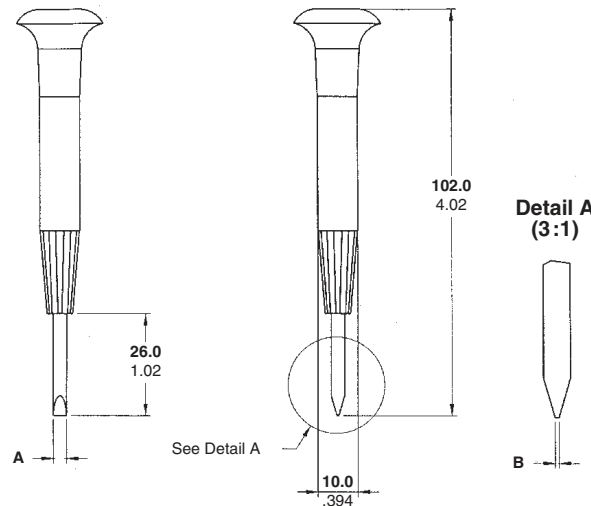

Screw	Dimensions		Part Number
	A	B	
M 1.6 [.063]	1.8 [.071]	0.3 [.012]	785730-1
M 3.0 [.118]	2.5 [.098]	0.6 [.024]	785730-2

Accessories (Continued)

PLASTI-GRIP
Wire Pins

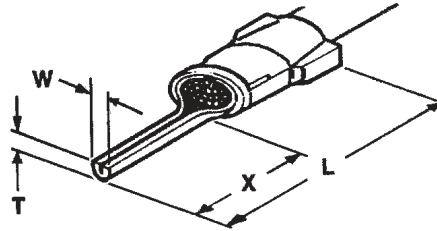

Wire Size Range AWG	Wire Size (mm ²)	DIN Wire Size Range (mm ²)	Insulation Diameter Max. (mm ²)	Insulation Color	Dimensions				Part Number	Packaging Unit	CERTI-CRIMP Hand Tool	
					X	W	T	L				
22-16	0.25-1.60	0.35-0.50-0.75- 1.00-1.50	0.5-1.0	3.7	Red	9.9 [.390]	1.8 [.071]	1.8 [.071]	23.8 [.937]	165167-0	100	47386
16-14	1.00-2.60	1.0-1.5-2.5	>1.0-2.5	4.9	Blue	6.7 [.264]	1.8 [.071]	1.8 [.071]	20.7 [.815]	165075	100	47387-7
						9.9 [.390]	1.8 [.071]	1.8 [.071]	23.7 [.933]	165171	100	47387-7
12-10	2.70-6.60	4.0-6.0	>2.5-6.0	6.4	Yellow	9.9 [.390]	2.6 [.102]	2.6 [.102]	29.2 [1.150]	165085-0	100	59239-4

PIDG

Wire Pins

Material and Finish

Pin – Copper, tin plated
Insulation Sleeve –
Nylon

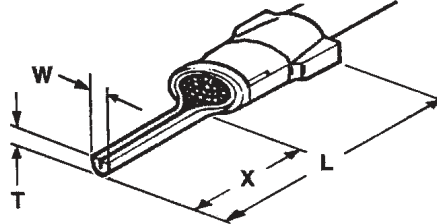

Wire Size Range AWG	Wire Size (mm ²)	DIN Wire Size Range (mm ²)	Insulation Diameter Max. (mm ²)	Insulation Color	Dimensions				Part Number	Packaging Unit	CERTI-CRIMP Hand Tool	
					X	W	T	L				
26-22	0.10-0.40	0.14-0.20- 0.25-0.35	0.14-0.35	2.1	Yellow	6.7 [.264]	1.1 [.043]	1.1 [.043]	18.2 [.717]	165514-1	500	46121
22-16	0.25-1.60	0.35-0.50-0.75- 1.00-1.50	0.5-1.0	3.6	Red	6.7 [.264]	1.8 [.071]	1.8 [.071]	19.7 [.776]	165142-0	500	47386
						9.9 [.390]	1.9 [.075]	1.8 [.071]	22.9 [.902]	165168-0	500	47386
						6.7 [.264]	1.8 [.071]	1.8 [.071]	20.3 [.799]	165046-0	500	47387-7
16-14	1.00-2.60	1.0-1.5-2.5	>1.0-2.5	4.3	Blue	9.9 [.390]	1.8 [.071]	1.8 [.071]	23.6 [.929]	165172-0	500	47387-7
						15.2 [.598]	2.7 [.106]	2.3 [.091]	29.1 [1.146]	9-160402-2	500	47387-7
12-10	2.70-6.60	4.0-6.0	>2.5-6.0	6.4	Yellow	9.9 [.390]	2.6 [.102]	2.6 [.102]	28.5 [1.122]	165049-0	500	59239-4

Related Product Data

For more information on AMP
Standard Terminals and Splices or
Quick-Connect FASTON Receptacles
and Tabs, request Catalog 82042.

Accessories (Continued)

Wire Ferrules

These Wire Ferrules, suitable for the most common wire range of 0.5 mm² through 10.0 mm², [20AWG-7AWG] are terminated with hand tools.

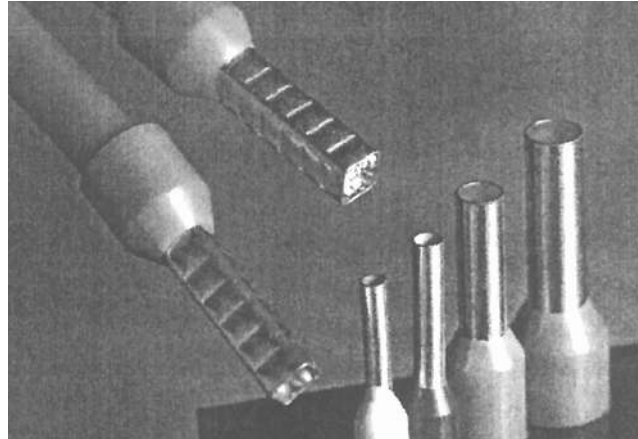

**DIN Wire Ferrules
Tubing Form
with Plastic Sleeve
According to DIN 46228,
Part 4**

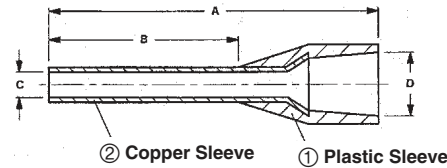

Wire Size Range AWG (mm ²)	Insulation Diameter Max	Version	Insulation Color	Dimensions				Strip Length	Part Number	Packaging Unit	
				A	B	C	D				
20	0.50	2.3 [.091]	Normal	White	14.0 [.551]	8.0 [.315]	1.0 [.039]	2.6 [.102]	10.0 [.394]	966067-2	500
18	0.75	2.5 [.098]	Normal	Grey	14.0 [.551]	8.0 [.315]	1.2 [.047]	2.8 [.110]	10.0 [.394]	966067-5	500
17	1.00	2.7 [.106]	Normal	Red	14.0 [.551]	8.0 [.315]	1.4 [.055]	3.0 [.118]	10.0 [.394]	966067-9	500
16	1.50	3.2 [.126]	Normal	Black	14.0 [.551]	8.0 [.315]	1.7 [.067]	3.5 [.138]	10.0 [.394]	1-966067-2	500
14	2.50	3.9 [.154]	Normal	Blue	14.0 [.551]	8.0 [.315]	2.2 [.087]	4.2 [.165]	10.0 [.394]	1-966067-6	500
11	4.00	4.5 [.177]	Normal	Grey	17.0 [.669]	10.0 [.394]	2.8 [.110]	4.8 [.189]	12.0 [.472]	1-966067-9	500
10	6.00	6.0 [.236]	Normal	Yellow	20.0 [.787]	12.0 [.472]	3.5 [.138]	6.3 [.248]	14.0 [.551]	2-966067-2	100
7	10.00	7.3 [.287]	Normal	Red	22.0 [.866]	12.0 [.472]	4.5 [.177]	7.6 [.299]	15.0 [.591]	2-966067-4	100

**Double Wire Ferrules
Tubing Form
with Plastic Sleeve,
According to DIN 46228,
Part 4**

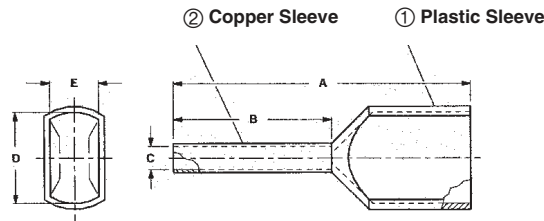

Wire Size Range AWG (mm ²)	Insulation Diameter Max	Version	Insulation Color	Dimensions					Strip Length	Part Number	Packaging Unit	
				A	B	C	D	E				
2 x 20	2 x 0.50	2.1 [.083]	Normal	White	15.0 [.591]	8.0 [.315]	1.40 [.055]	4.7 [.185]	2.5 [.098]	10.0 [.394]	966144-1	500
2 x 18	2 x 0.75	2.2 [.087]	Normal	Grey	15.0 [.591]	8.0 [.315]	1.70 [.067]	5.0 [.197]	2.8 [.110]	10.0 [.394]	966144-2	500
2 x 18	2 x 0.75	2.2 [.087]	Long	Grey	17.0 [.669]	10.0 [.394]	1.70 [.067]	5.0 [.197]	2.8 [.110]	12.0 [.472]	966144-3	500
2 x 17	2 x 1.00	2.5 [.098]	Normal	Red	15.0 [.591]	8.0 [.315]	1.95 [.077]	5.4 [.213]	3.4 [.134]	10.0 [.394]	966144-4	500
2 x 16	2 x 1.50	3.0 [.118]	Normal	Black	16.0 [.630]	8.0 [.315]	2.20 [.087]	6.6 [.260]	3.6 [.142]	10.0 [.394]	966144-6	500
2 x 14	2 x 2.50	3.6 [.142]	Normal	Blue	18.5 [.728]	10.0 [.394]	2.80 [.110]	7.8 [.307]	4.2 [.165]	12.0 [.472]	966144-8	250
2 x 11	2 x 4.00	4.1 [.161]	Normal	Grey	23.0 [.906]	12.0 [.472]	3.70 [.146]	8.8 [.346]	4.9 [.193]	14.0 [.551]	1-966144-0	100

Note: All part numbers are RoHS Compliant.

Accessories (Continued)

DIN Tubular End Sleeve with Plastic Sleeve

According to DIN 46228, Part 4, in Strip Form

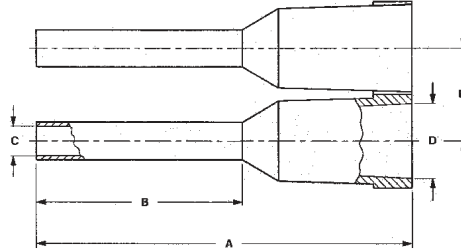

Wire Size Range AWG (mm ²)	Insulation Diameter Max.	Insulation Color	Dimensions					Strip Length	Part Number	Packaging Unit
			A	B	C	D	E			
20 0.50	2.4 [.094]	White	14.5 [.571]	8.0 [.315]	1.1 [.043]	2.8 [.110]	3.5 [.138]	10.0 [.394]	1241000-1	1,000
18 0.75	2.6 [.102]	Grey	14.5 [.571]	8.0 [.315]	1.3 [.051]	2.9 [.114]	3.5 [.138]	10.0 [.394]	1241001-1	1,000
17 1.00	2.9 [.114]	Red	14.5 [.571]	8.0 [.315]	1.5 [.059]	3.2 [.126]	3.9 [.154]	10.0 [.394]	1241002-1	1,000
16 1.50	3.2 [.126]	Black	14.5 [.571]	8.0 [.315]	1.8 [.071]	3.4 [.134]	4.1 [.161]	10.0 [.394]	1241003-1	1,000
14 2.50	4.0 [.157]	Blue	14.5 [.571]	8.0 [.315]	2.3 [.091]	4.3 [.169]	5.0 [.197]	10.0 [.394]	1241004-1	500
14 2.50	4.0 [.157]	Grey	14.5 [.571]	8.0 [.315]	2.3 [.091]	4.3 [.169]	5.0 [.197]	10.0 [.394]	1241004-2	500

Product Facts

- Self-adjusting rectangular crimp profile for DIN-style crimp
- Only two hand tools are needed to crimp wire sizes from 0.14 mm² through 10.0 mm²
- Adjustable crimp pressure
- Crimp control

Application Tooling

Crimp Hand Tool for Wire Ferrules

This newly designed self-adjusting die set offers a time-saving crimping process and uniform crimp. A ratchet system provides for a complete crimp cycle before releasing. The crimp is according to DIN specification.

The tool handles are contoured for comfort.

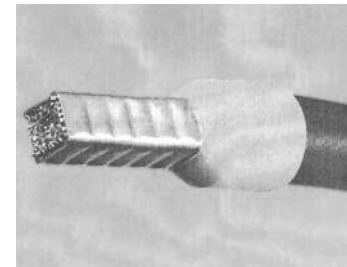
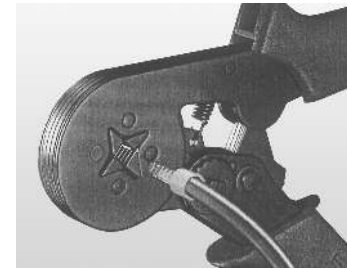

Loose Piece Tooling

Wire Size Range (mm ²)	Part Number
0.14-6.00	539660-1
0.75-10.0	539661-1

Strip Form Tooling

End Sleeve Part Number	Applicator Part No.		
	CLS IV+ Lead Maker	K Terminator	G Terminator
1241000-1	—*	—*	—*
1241001-1	—*	—*	—*
1241002-2	—*	—*	—*
1241003-1	—*	—*	—*
1241004-1	—*	—*	—*
1241004-2	—*	—*	—*

*Contact the Tooling Assistance Center for Part Number

Note: All part numbers
are RoHS Compliant.

Engineering Notes



Note: All part numbers are RoHS Compliant.



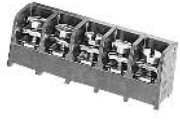





Table of Contents—Barrier Strips

Overview	114-118
(Barrier Strip Selector Chart)	114, 115
Tri-Barrier Strips	119-138
0.250" Pitch	120-123
0.325" Pitch	124-127
0.375" Pitch	128-135
0.4375" Pitch	136-138
Dual-Barrier Strips	139-160
0.250" Pitch	141-142
0.325" Pitch	143-146
0.375" Pitch	147-150
0.4375" Pitch	151-154
0.375" Double Row, Panel Mount	155-156
0.433" Double Row, Panel Mount	157
0.437" Double Row, Panel Mount	158
0.563" Double Row, Panel Mount	160
Sockets and Barrier Strips	161-173
0.325" Pitch, Series USB3 Socket	162
0.375" Pitch, Series RSB6B Socket	163
0.325" Pitch, Series RSB3 Tri-Barrier	164-166
0.325" Pitch, Series SSB3 Dual-Barrier	168-170
0.375" Pitch, Series RSB6 Tri-Barrier	171-173
Accessories	174-179







Note: All part numbers are RoHS Compliant.

Barrier Strip Selector Chart

Tri-Barrier

								
	0.250"	0.325"	0.325"	0.375"	0.375"	0.375"	0.375"	0.4375"
Series	#3	#4	1546927	#6	1546833	BC6	MB6	#8
Pitch (in)	0.250"	0.325"	0.325"	0.375"	0.375"	0.375"	0.375"	0.4375"
Circuits	2-32	2-30	2-8	2-30	2-8	2-16	4-40	2-26
Max Current	10A	25A	15A	25A	15A	20A	25A	30A
Max Voltage	300V	300V	300V	600V	300V	300V	300V	600V
Wire Range (AWG)	18-22	12-22	14-22	12-22	14-22	12-22	12-22	10-18
Description	Molded to length	Molded to length	Molded to length	Molded to length	Molded to length, Modular	Molded to length	Double Level snapped to length	Molded to length
Page	120-123	124-126	127	128-131	132	133-134	135	136-138

Dual-Barrier

						
	.250"	0.325"	0.325"	0.375"	0.375"	0.4375"
Series	1546657	4DB	1546734	JC6	NC6	SSB7
Pitch (in)	.250"	0.325"	0.325"	0.375"	0.375"	0.4375"
Circuits	2-30	2-30	2-16	2-16	2-30	2-27
Max Current	10A	20A	20A	20A	20A	20A
Max Voltage	300V	150V/ 300V	300V	300V	300V	600V
Wire Range (AWG)	16-30	14-22	12-22	12-22	12-22	12-26
Description	Molded to length	Molded to length	High Rise, Molded to length	Molded to length	Low Profile version, Molded to length	Cut to length
Page	141-142	143-144	145-146	147-148	149-150	151-154

Note: All part numbers are RoHS Compliant.

Barrier Strip Selector Chart (Continued)

Double Row

	0.374"	0.433"	0.437"	0.563"	
Series	1546306 1546307	1546481 1546477	1546670 1546671	1546310 1546311	1776544 1986158
Pitch (in)	0.374"	0.433"	0.437"	0.563"	0.563"
Circuits	2-30	2-26	2-26	2-18	2-18
Max Current	20A	25A	25A	30A	30A
Max Voltage	300V	300V	300V	300V	600V
Wire Range (AWG)	12-22	14-22	14-22	10-22	10-22
Description	Panel Mount, molded to length	Panel Mount, molded to length	Panel Mount, molded to length	Panel Mount, molded to length	Panel Mount, molded to length
Page	156	157	158	159	160

Sockets and Barrier Strips



	0.325"	0.325"	0.325"	0.375"	0.375"
Series	USB	RSB3	SSB3	RSB6B	RSB6
Pitch (in)	0.325"	0.325"	0.325"	0.375"	0.375"
Circuits	2-12	2-36	2-36	2-10	2-36
Max Current	10A	15A	15A	10A	20A
Max Voltage	300V	300V	300V	300V	300V
Wire Range (AWG)	n/a	14-26	14-26	n/a	12-26
Description	For Series RSB3 & SSB3	Cut to length	Cut to length	For Series RSB6	Cut to length
Page	162	164-166	168-170	163	171-173

Note: All part numbers are RoHS Compliant.

Catalog Number Code

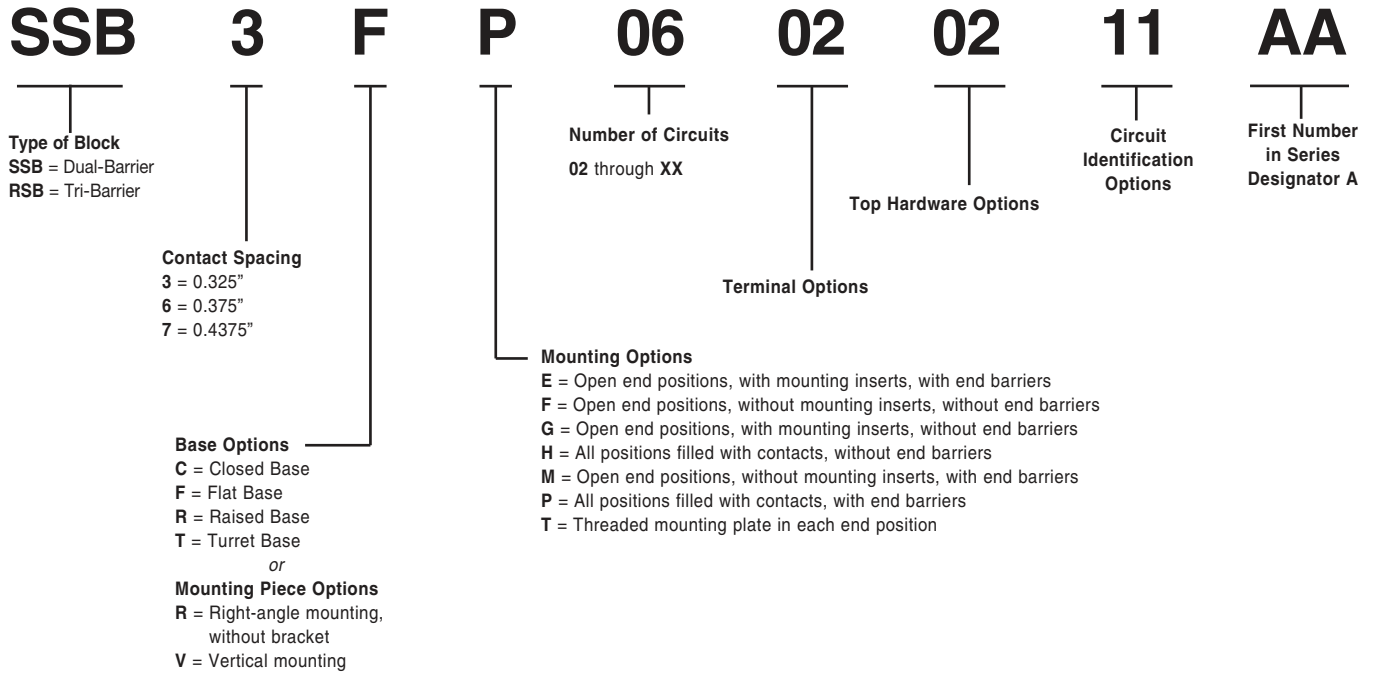

OPTIONAL TERMINAL IDENTIFICATION

Select the desired version from the list below and add the CODE NUMBER (11, 12, 15 or 16) to the end of the catalog number of the connector or header.

- CODE
11 = 1 2 3 4 . . .
12 = . . . 4 3 2 1
15 = . . . † 3 5 †
16 = † 5 3 † . . .

*"First Number In Series" Designator**

- | | |
|-------|-------|
| A = 1 | F = 6 |
| B = 2 | G = 7 |
| C = 3 | H = 8 |
| D = 4 | J = 9 |
| E = 5 | K = 0 |

* Letters in this position designate the first number to be used in the consecutive sequence. Ex.: "A" would start the sequence with the number 1. "EK" would start the sequence with the number 50. "BKK" would start the series with 200. For non-sequential numbering and special characters, consult Technical Support.

Note: Some catalog number combinations are not valid. Check appropriate catalog pages before ordering. Catalog numbering code applies only to the catalog numbers on pages 125, 148-151, 164-169.

Note: All part numbers are RoHS Compliant.

Catalog Number Code (Continued)

6 PCV-04-XXX

Contact Spacing

- 3 = 0.250"
- 4 = 0.325"
- 6 = 0.375"
- 8 = 0.4375"

Suffix (if applicable)

Number of Circuits
02 through XX

Terminal Style

- DBL** = Double Printed Circuit Pin
- PCR** = Printed Circuit, Right Angle
- PCV** = Printed Circuit Pin, Vertical
- QCR** = Quick Connect Tab, Right Angle
- QCV** = Quick Connect Tab, Vertical
- STR** = Solder Turret, Right Angle
- STV** = Solder Turret, Vertical
- TBV** = Non Feed Thru
- WWR** = Solderless Wire Wrap, Right Angle
- WWV** = Solderless Wire Wrap, Vertical

Barrier Strips
2

Note: Some catalog number combinations are not valid. Check appropriate catalog pages before ordering. Catalog numbering code applies only to the catalog numbers on pages 119-124, 127-129, 134-136.

Note: All part numbers are RoHS Compliant.

Barrier Strips – Overview

Two Types of Barrier Strips and a Line of Sockets:

Tri-Barrier

Three walls or barriers surround each terminal screw. The back wall safeguards field wiring.



Dual-Barrier

Two walls or barriers are molded on each side of the terminal screw.

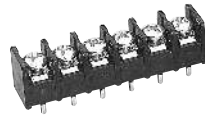

Sockets

Mounted directly to the PC board, the Barrier Strip is plugged into the socket. The socket expedites field maintenance. (Below, a tri-barrier is about to be mounted in a socket.)



Wire Clamp Screws

The lower surface and edges of the clamping-plates are carefully designed to securely clamp the wire—even combinations of different wire sizes—without severing stranded wire. Extra care has been taken to produce these components without burrs on any critical clamping surface or edges.

Resilient Plastic Barriers

Flexible thermoplastic material for terminal blocks was an especially important feature at the time of its introduction, since many earlier blocks were molded of more rigid, brittle thermosetting plastic compounds.

Wire-Ready Raised Screws

Wire-ready raised screws are standard on BUCHANAN terminal blocks. No need to back off the screw first. Just insert the wire and drive down the screw. Wire installation time and effort are virtually cut in half.

Integral Standoffs

Standoffs help rid your PCB of any remaining corrosive agents during rinsing operations. Helps prevent trapped solutions in the immediate PC pin area. Significantly reduces the risk of postwave corrosion problems.

Gas-Tight Connections

The acid-tin plating on our terminals means more than just improved shelf-life and superior solderability. It is to provide the very basis for the heart of your wire connections.

Quality Plating

Tyco Electronics Corporation has been known for its plating, especially on the tin-plated components, and has maintained stringent plating specifications to provide a better performing, more reliable product. (Terminals meet or exceed Tyco Electronics Specification 109-11-1.)

UL Recognition and CSA Certification

Terminal blocks and interconnect components are Recognized under the Component Recognition Program of Underwriters Laboratories Inc. and Certified by Canadian Standards Association. (Consult individual sections of this catalog for status of a specific series.)

Typical Application

Pictured below is a PC board with barrier strips and sockets wave soldered to it.

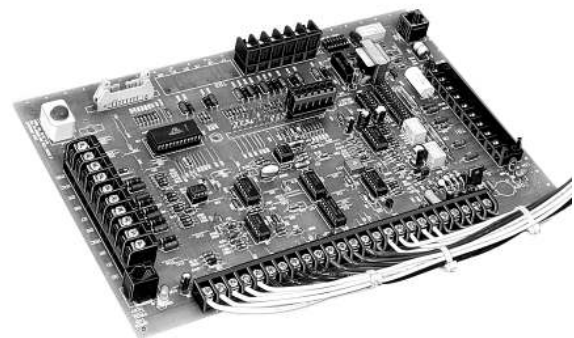

Tri-Barrier Strips

Product Facts

- n Industrial controls and automation
- n Machine tools
- n HVAC/R
- n Power supplies
- n Security/Irrigation
- n Transformers

Design Advantages

- n Back barriers to safeguard field wiring
- n Fast wiring – backed-out wire-ready screws
- n Interrupted thread designed to prevent screws from falling out
- n Standoffs allow flux and solvents to drain during cleaning
- n Molded-to-length or cut-to-length versions available
- n Phil-slot screws are standard
- n RoHS compatible

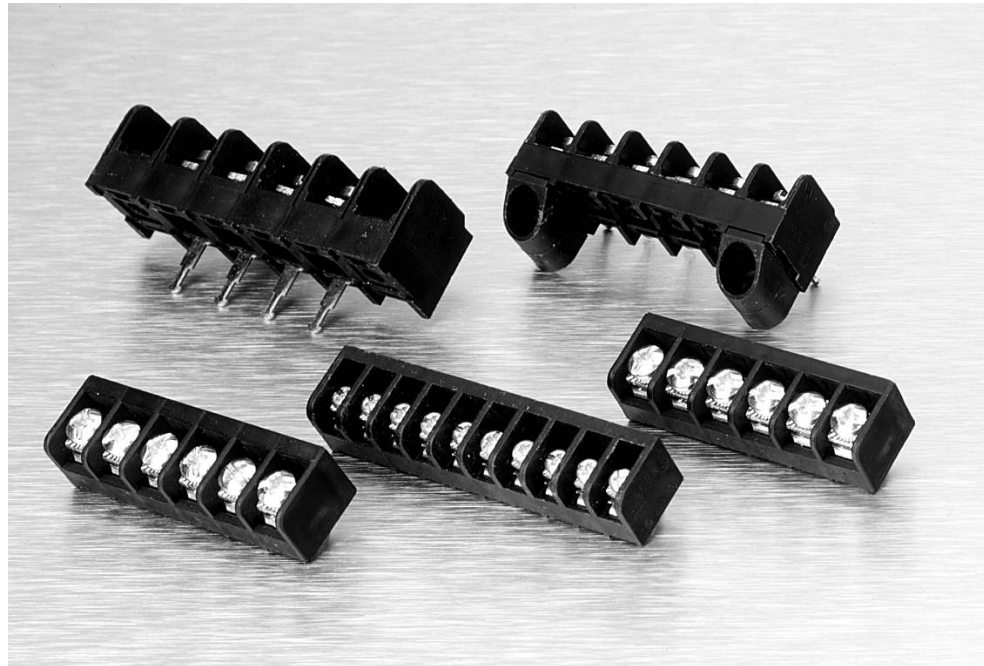

Tri-Barrier blocks help contain stray or frayed wire ends. This helps prevent electrical shorts — not only between positions on the same block, but also between other components immediately adjacent to the block. With today’s high-density PCB designs, this has become an increasingly important feature.

Connector Index

0.250" Pitch, Series #3	120-123
0.325" Pitch, Series #4	124-126
0.325" Pitch, with Attached Safety Cover	127
0.375" Pitch, Series #6	128-135
0.375" Pitch, Modular with Cover	132
0.375" Pitch, Series BC6, Panel Mount.....	133,134
0.375" Pitch, Series MB6, Double Level	135
0.4375" Pitch, Series #8	136-138

.250" [6.35] Pitch, Series #3

3PCV-03-006 & 3PCV-10-006

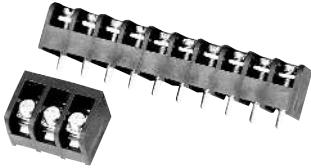

Material & Finish

Housing Material—Polypropylene

Flammability—UL94V-0

Color—Black

Terminals—Bright acid tin over copper alloy

Screws—Steel, zinc plating with clear chromate coating. Wire clamping screws standard.

Mechanical Properties

Pitch (Terminal Spacing)—0.250" [6.35]

Recommended PCB Hole Dia.—1.8mm [.073"] Recommended Tightening Torque: 5.5 in.-lbs.

Electrical Properties

Ratings—UL Class C 10 Amps, 150V
UL Class D 10 Amps, 300V
CSA Type C 10 Amps, 150V
CSA Type D 10 Amps, 300V

Wire Range—18-22 AWG

Environmental Properties

Operating Temperature Range—105°C [221°F] max.

Circuit Identification—See page 179

Hardware Options

TC3—Safety cover, see page 174

J3—Jumper, see page 177

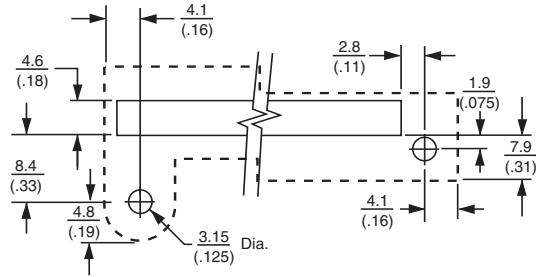

RIGHT ANGLE MOUNTING PANEL LAYOUT VERTICAL

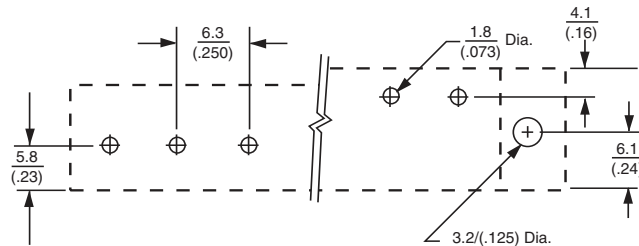



RIGHT ANGLE PRINTED CIRCUIT LAYOUT CENTER

.250" [6.35] Pitch, Series #3 (Continued)

Ordering Information

3 PCV - 04 - 006

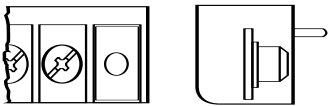
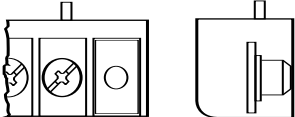
- A** **Thread Size Spacing**
3 = #m3 on .250" Centers
- B** **Terminal Style**
PCV = Printed Circuit Pin, Vertical
PCR = Printed Circuit, Right Angle
STV = Solder Turret, Vertical
STR = Solder Turret, Right Angle
WWV = Solderless Wire Wrap, Vertical
- C** **No. of Circuits** (Not Positions)
02 through 32
- D** **Modifier**
Use table below.

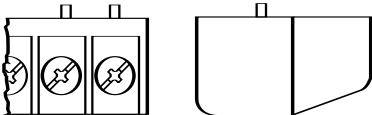
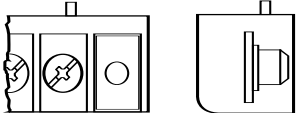
Terminal Style	Modifier Phil-slot Head	Screw Style	Mounting Construction
PCV	006	Wire Clamp	No Mounting
	008	Wire Clamp	
PCR	006	Wire Clamp	No Mounting
	008	Wire Clamp	
STV WWV	006	Wire Clamp	
	008	Wire Clamp	No Mounting
STR	006	Wire Clamp	
	008	Wire Clamp	



Note: All part numbers are RoHS Compliant.

.250" [6.35] Pitch, Series #3 (Continued)

Printed Circuit Pin

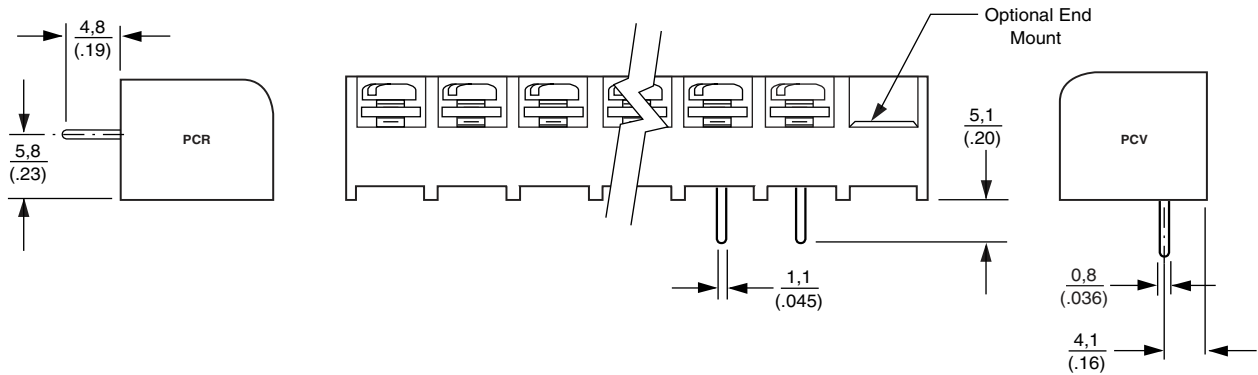

Solder Turret

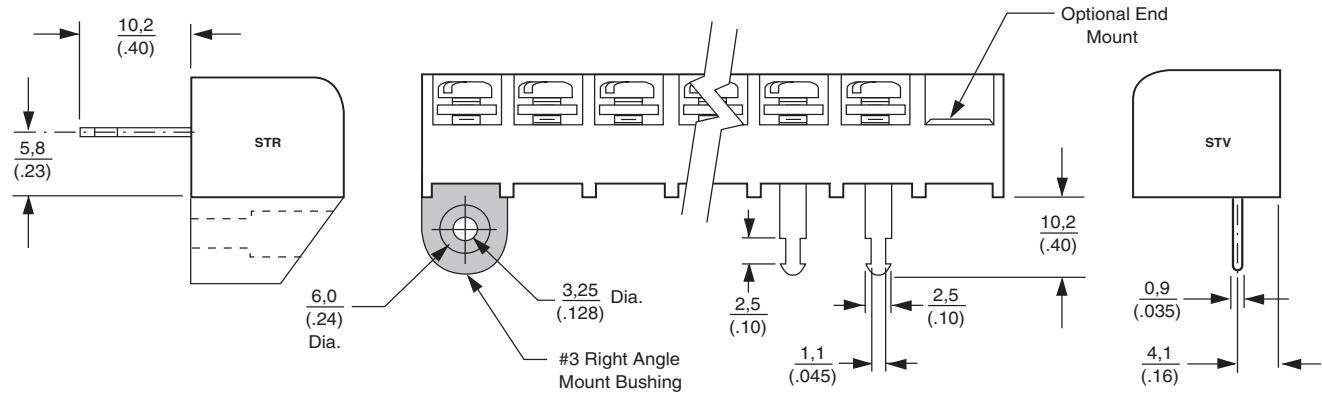

Wire Wrap

#3WWR not available

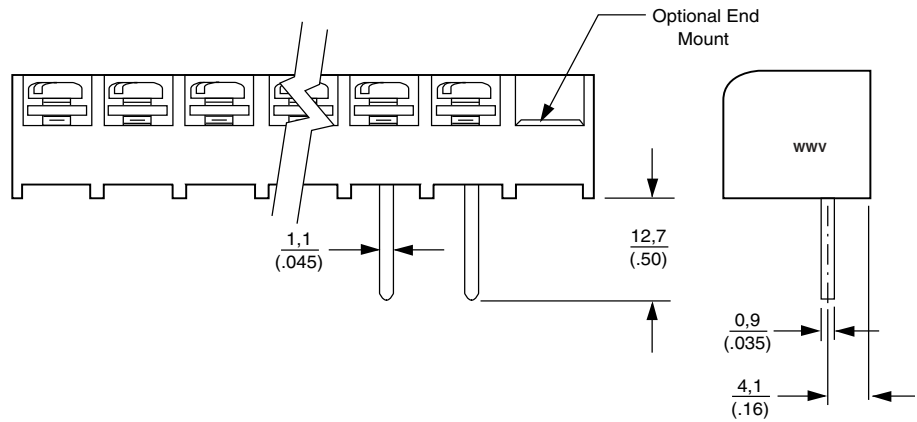

Note: All part numbers are RoHS Compliant.

.250" [6.35] Pitch, Series #3 (Continued)

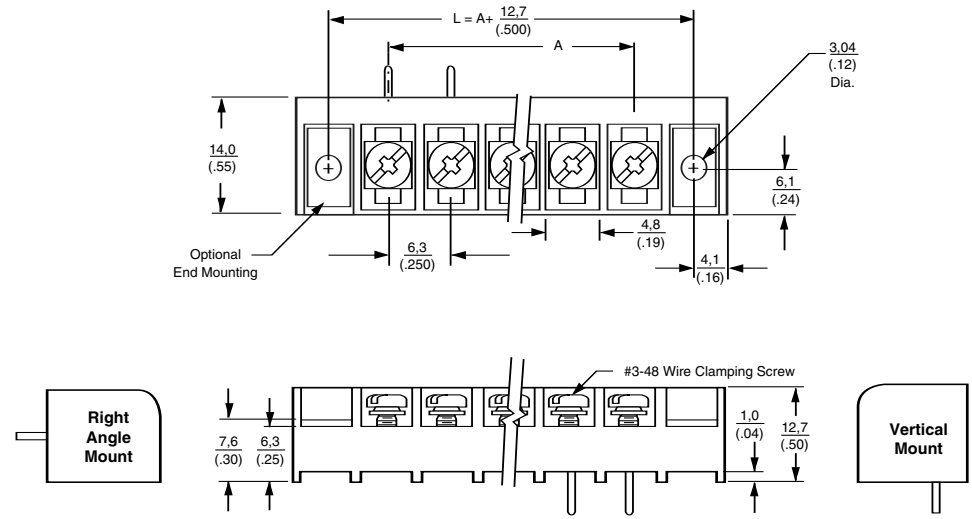

No. of Positions	Dim. A
2	0.25 [6.3]
3	0.50 [12.7]
4	0.75 [19.0]
5	1.00 [25.4]
6	1.25 [31.7]
7	1.50 [38.1]
8	1.75 [44.4]
9	2.00 [50.8]
10	2.25 [57.1]
11	2.50 [63.5]
12	2.75 [69.8]
13	3.00 [76.2]
14	3.25 [82.5]
15	3.50 [88.9]
16	3.75 [95.2]
17	4.00 [101.6]

No. of Positions	Dim. A
18	4.25 [107.9]
19	4.50 [114.3]
20	4.75 [120.6]
21	5.00 [127.0]
22	5.25 [133.3]
23	5.50 [139.7]
24	5.75 [146.0]
25	6.00 [152.4]
26	6.25 [158.8]
27	6.50 [165.1]
28	6.75 [171.5]
29	7.00 [177.8]
30	7.25 [184.2]
31	7.50 [190.5]
32	7.75 [196.9]

Barrier Strips

2



0.325" [8.26] Pitch, Series #4, Tri-Barrier

4PCV-06-006



Material & Finish

Housing Material—Polyamide

Flammability—UL94V-0

Color—Black

Terminals—Bright acid tin over copper alloy

Screws—#4-40 steel, zinc plating with clear chromate coating. Wire clamping screw and binding head screw available.

Mechanical Properties

Pitch (Terminal Spacing)—0.325" [8.255]

Recommended PCB Hole Dia.—1.8mm [.073"]

Recommended Tightening Torque—7 in.-lbs. max.

Electrical Properties

Ratings—UL Class C 20 Amps, 150V
UL Class D 10 Amps, 300V
CSA Type C 20 Amps, 150V
CSA Type D 10 Amps, 300V

Wire Range—12-22 AWG

Environmental Properties

Operating Temperature Range—105°C [221°F] max.

Circuit Identification—See page 179

Hardware Options

TC4—Safety cover, see page 174

8-1437649-0—Wire clamp screw, see page 178

8-1437649-0—Binding head screw, see page 178

J4—Jumper, see page 177

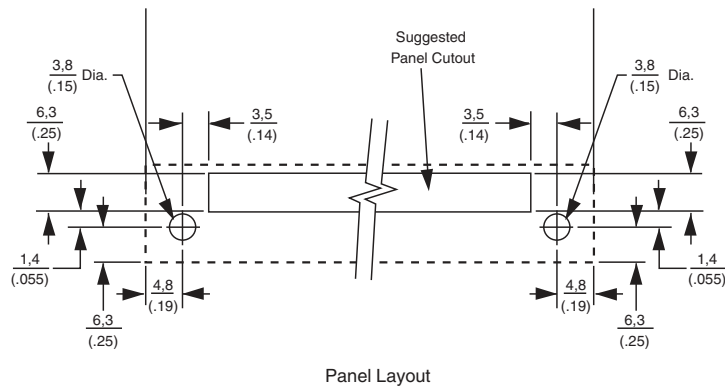
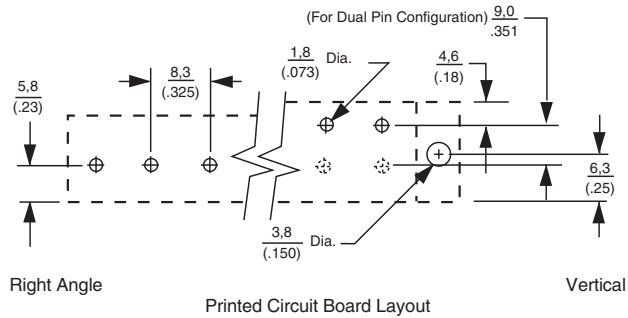

0.325" [8.26] Pitch, Series #4, Tri-Barrier (Continued)

Ordering Information

4 PCV-04-006

A **B** **C** **D**

A Screw Size Spacing

4 = #4-40 on .325" Centers

C No. of Circuits (Not Positions)

02 through 30

B Terminal Style

DBL = Double Printed Circuit Pin

PCR = Printed Circuit, Right Angle

PCV = Printed Circuit Pin, Vertical

WWV = Solderless Wire Wrap, Vertical

D Modifiers

Use table below.

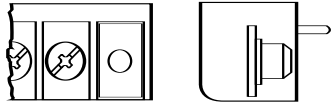
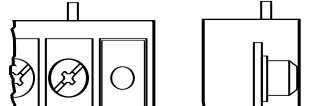
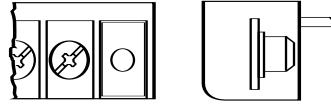
Terminal Style	Modifier Phil-slot Head	Screw Style	Mounting Construction
DBL	006	Wire Clamp	No Mounting
PCV	006	Wire Clamp	No Mounting
	008	Wire Clamp	
PCR	006	Wire Clamp	No Mounting
	008	Wire Clamp	
WWV	006	Wire Clamp	
	008	Wire Clamp	No Mounting



Note: All part numbers are RoHS Compliant.

0.325" [8.26] Pitch, Series #4, Tri-Barrier (Continued)

Printed Circuit Pin

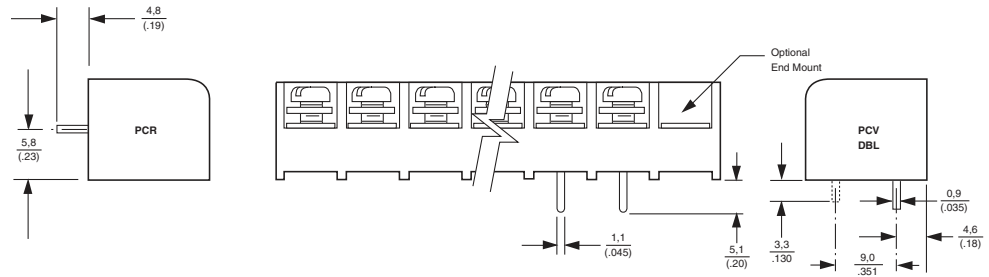

Wire Wrap

#4 WWR Not available

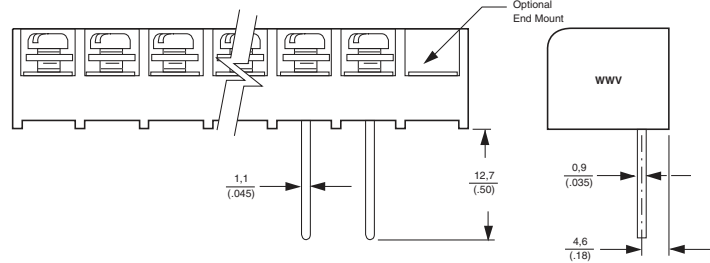

0.325" Pitch, Series #4, Tri-Barrier

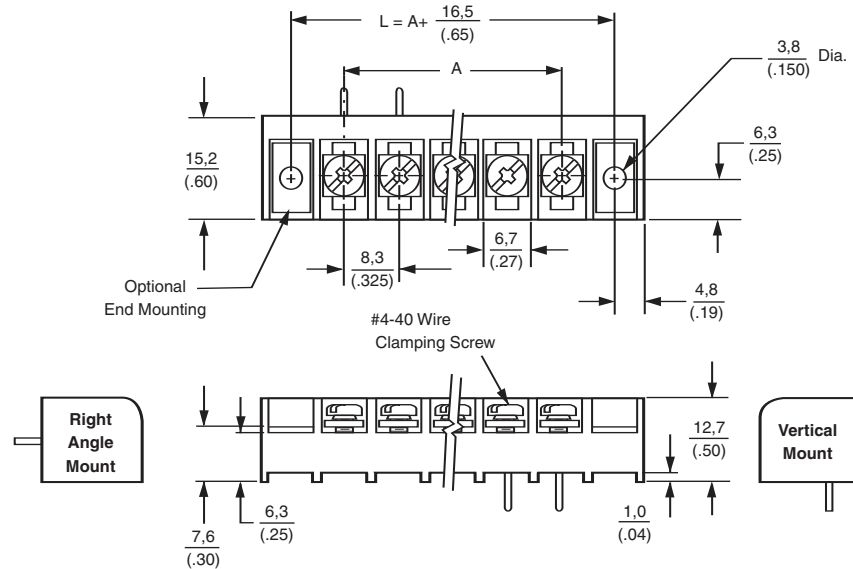

No. of Positions	Dim. A	No. of Positions	Dim. A
2	(0.325) 8,2	17	(5.20) 132,1
3	(0.65) 16,5	18	(5.52) 140,3
4	(0.97) 24,7	19	(5.85) 148,6
5	(1.30) 33,0	20	(6.17) 156,8
6	(1.62) 41,3	21	(6.50) 165,1
7	(1.95) 49,5	22	(6.82) 173,3
8	(2.27) 57,8	23	(7.15) 181,6
9	(2.60) 66,0	24	(7.47) 189,9
10	(2.92) 74,3	25	(7.80) 198,1
11	(3.25) 82,5	26	(8.13) 206,4
12	(3.57) 90,8	27	(8.45) 214,6
13	(3.90) 99,1	28	(8.78) 222,9
14	(4.22) 107,3	29	(9.10) 231,1
15	(4.55) 115,6	30	(9.43) 239,4
16	(4.87) 123,8		



Tri-Barrier Strips with Attached Safety Covers, .325" [8.26] Centerline

Product Facts

- ▢ Screwdriver access holes in cover allow for efficient wiring; cover may remain closed



Material & Finish

Insulator Body—UL 94V-0 Thermoplastic, black

Terminal—Brass, tin-plated

Mechanical Properties

Recommended screw tightening torque—12 in-lbs

Combination drive screws with #2 Phillips recess and standard slot

Electrical Properties

Current Rating—15 A

Voltage Rating—300 VAC/DC

Wire Range—22-14 AWG, Cu, Solid or Stranded

Environmental Properties

Operating Temperature—-40°C to +120°C [-104°F to +248°F]

Circuit Identification—See page 179

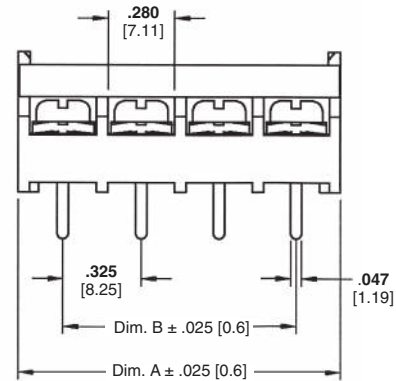
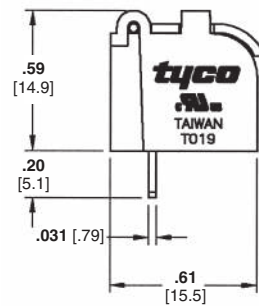
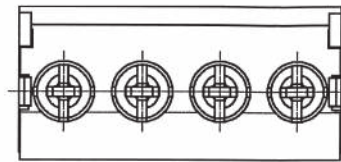

No. of Position*	Dimensions		Part Numbers
	A	B	
2	0.697 [17.7]	0.325 [8.3]	1546927-2
3	1.022 [26.0]	0.650 [16.5]	1546927-3
4	1.347 [34.2]	0.975 [24.8]	1546927-4
5	1.672 [42.5]	1.300 [33.0]	1546927-5
6	1.997 [50.7]	1.625 [41.3]	1546927-6
7	2.322 [59.0]	1.950 [49.5]	1546927-7
8	2.647 [67.2]	2.275 [57.8]	1546927-8

*Contact Tyco Electronics for larger position sizes.
Note: Samples available in Sample Room.

0.375" [9.53] Pitch, Series #6, Tri-Barrier

6PCV-03-006 & 6PCV-06-006

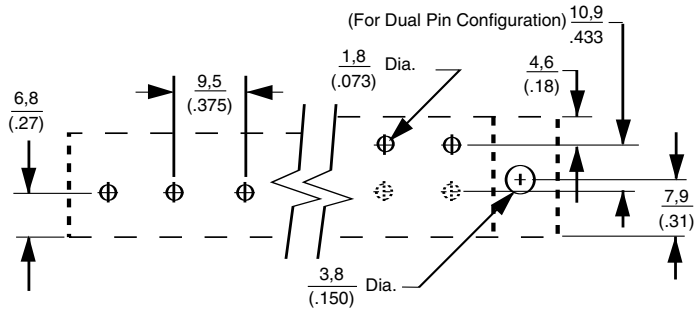
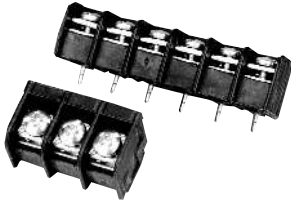

Right Angle
Printed Circuit Board Layout

Material & Finish

Housing Material—Polyamide

Flammability—UL94V-0

Color—Black

Terminals—Bright acid tin over copper alloy

Screws—#6-32 steel, zinc plating with clear chromate coating. Wire clamping screws and binding head screws with undercut available.

Mechanical Properties

Pitch (Terminal Spacing)—0.375" [9.53]

Recommended PCB Hole Dia.—1.8mm [.073"]

Electrical Properties

Ratings—UL Class C 25 Amps, 300V
UL Class D 5 Amps, 600V
CSA Type C 25 Amps, 300V
CSA Type D 5 Amps, 600V

Wire Range—18-22 AWG

Environmental Properties

Operating Temperature Range—105°C [221°F] max.

Circuit Identification—See page 179

Hardware Options

QC6—Quick connects, see page 176

ST80—Single sided solder tabs, see page 176

J6—Jumpers, see page 177

TC6—Safety covers, see page 174

1437651-2—Wire clamp screw, steel, see page 178

1437651-5—Wire clamp screw, brass, see page 178

1437651-8—Binding head screw, steel, see page 178

L03—Binding head screw, stainless, see page 178

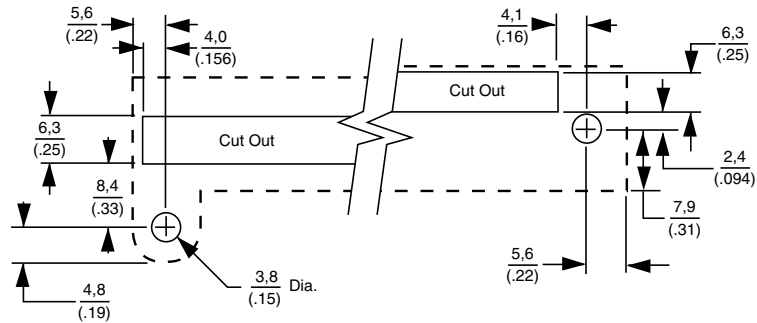



Right Angle
Mounting Panel Layout

0.375" [9.53] Pitch, Series #6, Tri-Barrier (Continued)

6 PCV-04-006

A **B** **C** **D**

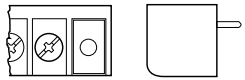
- A Screw Size Spacing**
6 = #6-32 on .375" Centers
- B Terminal Style**
DBL = Double Printed Circuit Pin
PCR = Printed Circuit, Right Angle
PCV = Printed Circuit Pin, Vertical
STR = Solder Turret, Right Angle
STV = Solder Turret, Vertical
TBV = Non Feed Thru
WWR = Solderless Wire Wrap, Right Angle
WWV = Solderless Wire Wrap, Vertical
- C No. of Circuits (Not positions)**
02 through 30
- D Modifiers**
Use table below.
-002=-006 except brass screw
-003=-007 except brass screw

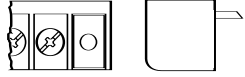
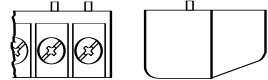
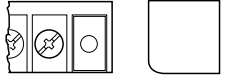
Terminal Style	Modifier Phil-slot Head	Screw Style	Mounting Construction
DBL	006	Wire Clamp	No Mounting
	007	Binding Head	
PCV	006	Wire Clamp	No Mounting
	007	Binding Head	
	008	Wire Clamp	
	009	Binding Head	
PCR	006	Wire Clamp	No Mounting
	007	Binding Head	
	008	Wire Clamp	
	009	Binding Head	
STV WWV	006	Wire Clamp	
	008	Wire Clamp	
STR WWR	006	Wire Clamp	
	008	Wire Clamp	
TBV	006	Wire Clamp	



Note: All part numbers are RoHS Compliant.

0.375" [9.53] Pitch, Series #6, Tri-Barrier (Continued)

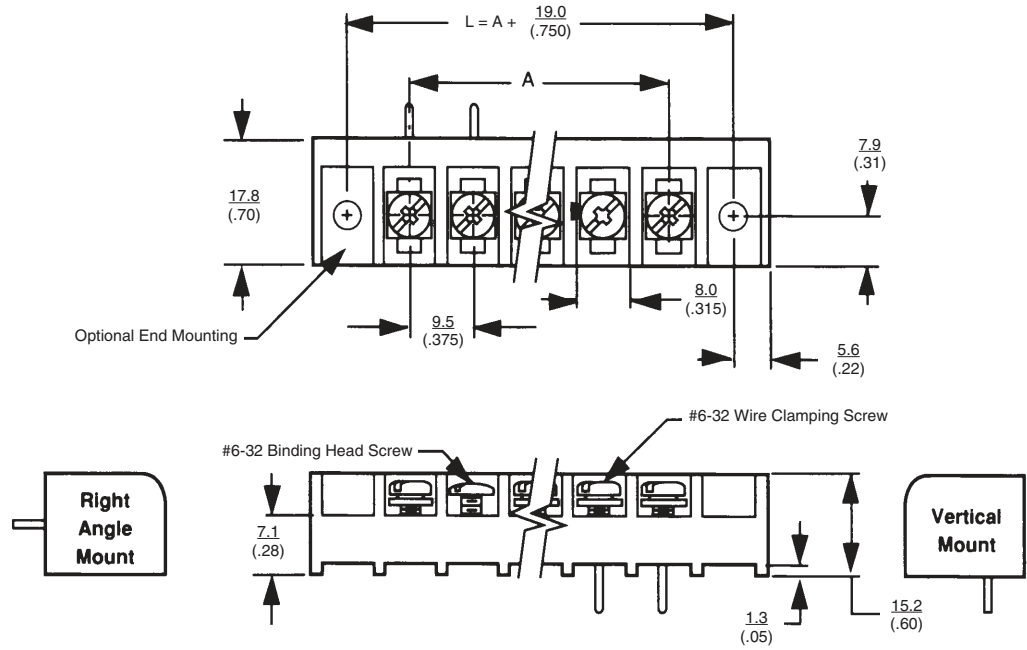

No. of Positions	Dim. A	No. of Positions	Dim. A
2	0.375 [9.5]	17	6.00 [152.4]
3	0.75 [19.1]	18	6.37 [161.9]
4	1.12 [28.6]	19	6.75 [171.4]
5	1.50 [38.1]	20	7.12 [181.9]
6	1.87 [47.6]	21	7.50 [190.5]
7	2.25 [57.1]	22	7.87 [200.0]
8	2.62 [66.7]	23	8.25 [209.5]
9	3.00 [76.2]	24	8.62 [219.1]
10	3.37 [85.7]	25	9.00 [228.6]
11	3.75 [95.2]	26	9.38 [238.1]
12	4.12 [104.8]	27	9.75 [247.7]
13	4.50 [114.3]	28	10.13 [257.2]
14	4.87 [123.8]	29	10.50 [266.7]
15	5.25 [133.3]	30	10.88 [276.2]
16	5.62 [142.9]		

Note: All part numbers are RoHS Compliant.

0.375" [9.53] Pitch, Series #6, Tri-Barrier (Continued)

Printed Circuit Pin

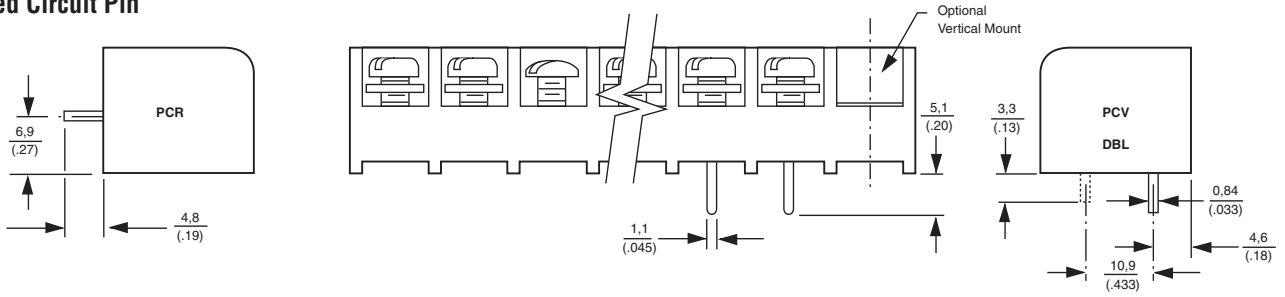

Solder Turret

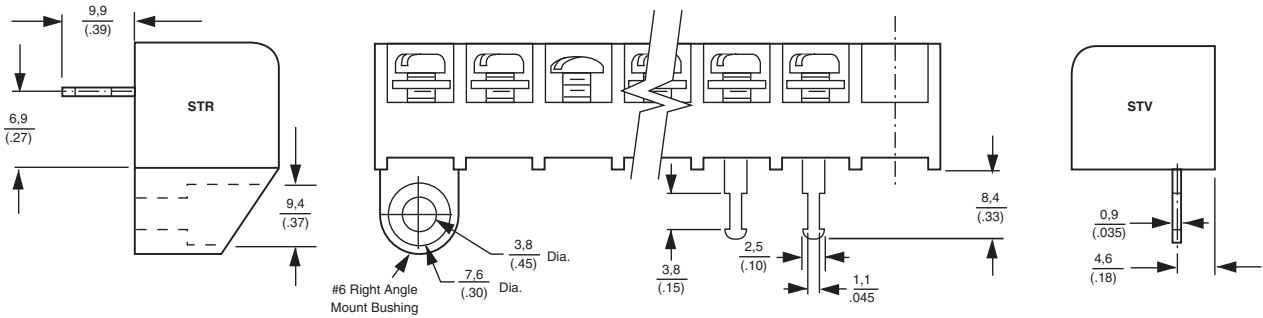

Wire Wrap

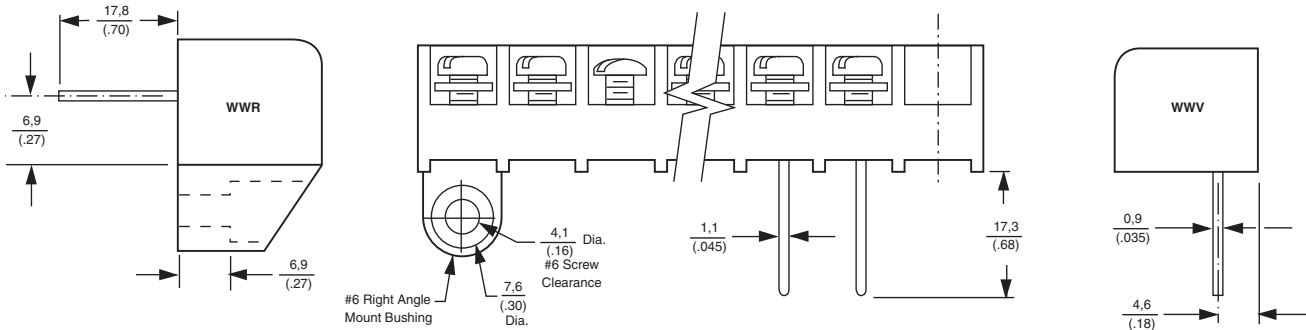

Non-Feed Thru

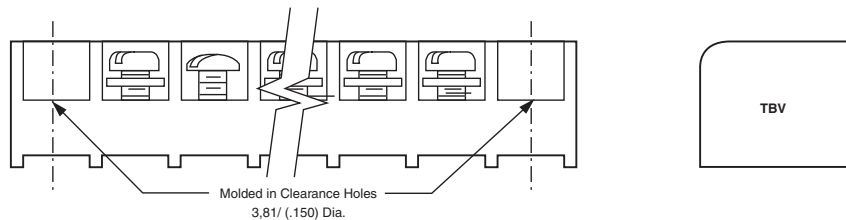

Barrier Strips

2



Note: All part numbers are RoHS Compliant.

0.375" [9.53] Pitch, Modular w/cover, Tri-Barrier

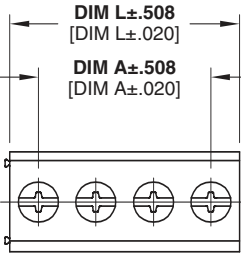

Material & Finish

Housing Material—Polyamide

Flammability—UL94V-0

Color—Black

Terminals—Brass, tin-plated

Screws—m3.5, steel, nickel plated

Mechanical Properties

Pitch (Terminal Spacing)—
0.375" [9.53]

Recommended PCB Hole Dia.—
1.8mm [0.073"]

Recommended Tightening Torque—
12 in.-lb.

Electrical Properties

Ratings*—UL Class B 15 Amps, 300V
UL Class D 10 Amps, 300V

*Evaluated to U.S. and Canadian Standards.

Wire Range—18-22 AWG

Environmental Properties

Operating Temperature Range—
-40°C to +120°C [-104°F to +248°F]

Circuit Identification—See page 179

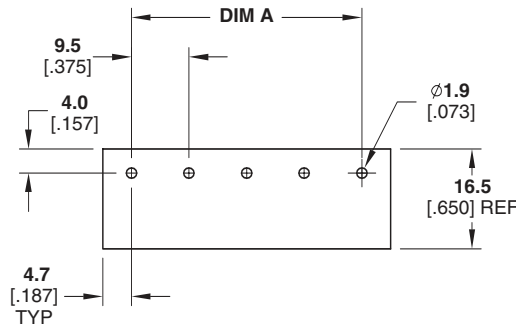
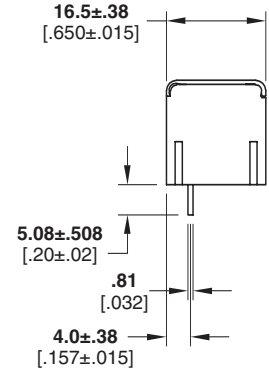
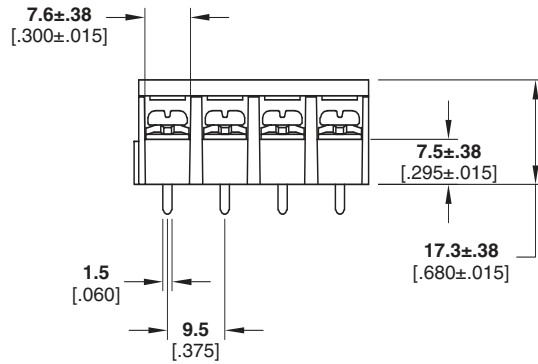

Recommended PC Board Layout

No. of Positions	Dimension A	Part Numbers
2	.375 [9.5]	1546833-2
3	.750 [19.0]	1546833-3
4	1.125 [28.6]	1546833-4
5	1.500 [38.1]	1546833-5
6	1.875 [47.6]	1546833-6
7	2.250 [57.1]	1546833-7
8	2.625 [66.7]	1546833-8



Note: All part numbers are RoHS Compliant.

0.375" [9.53] Pitch, Series BC6

No. of Positions	Dim. A
2	.375 [9.5]
3	.750 [19.1]
4	1.125 [28.6]
5	1.500 [38.1]
6	1.875 [47.6]
7	2.250 [57.1]
8	2.625 [66.7]
9	3.000 [76.2]

No. of Positions	Dim. A
10	3.375 [85.7]
11	3.750 [95.2]
12	4.125 [104.8]
13	4.500 [114.3]
14	4.875 [123.8]
15	5.250 [133.3]
16	5.625 [142.9]

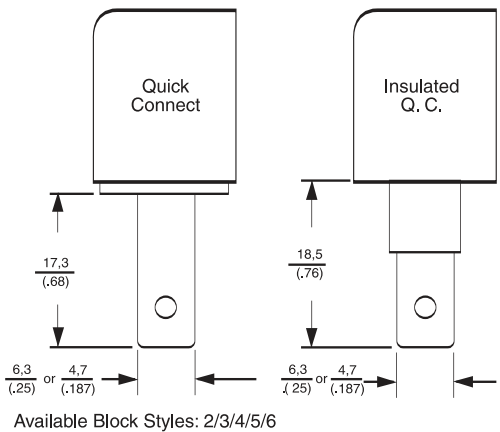
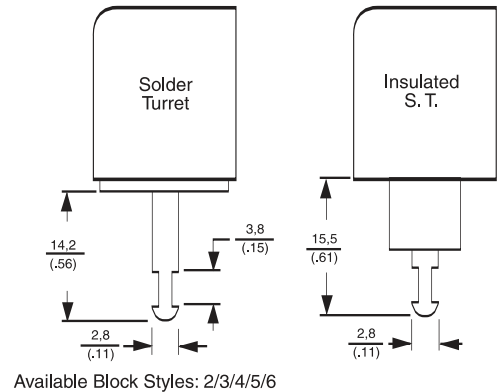
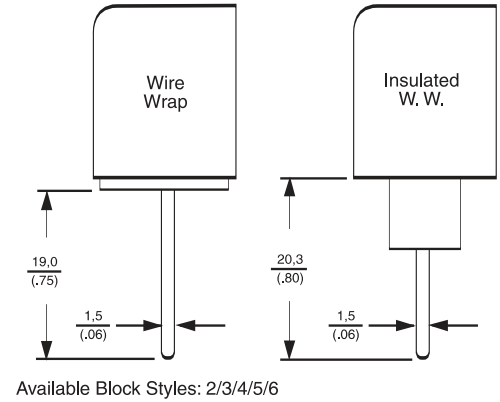
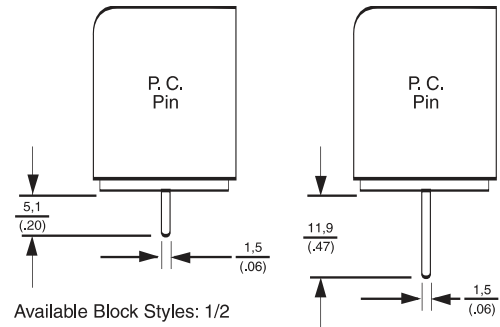
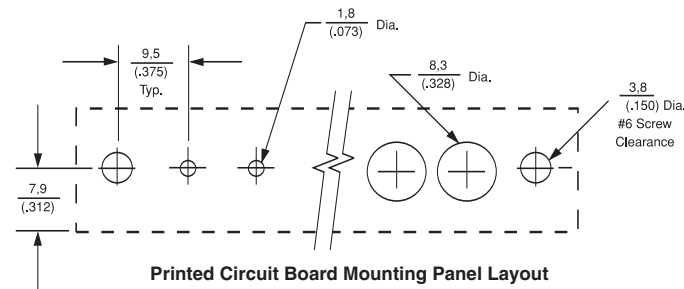
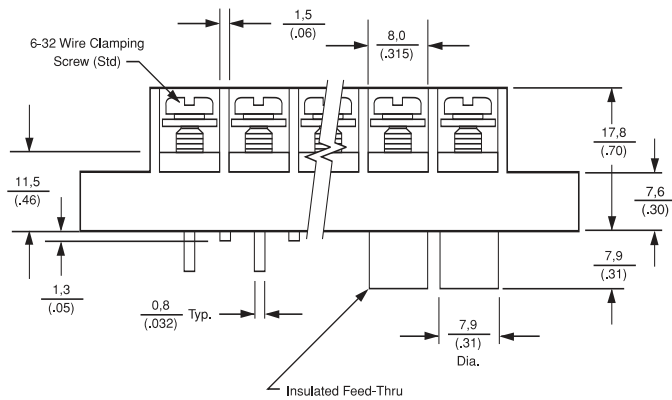
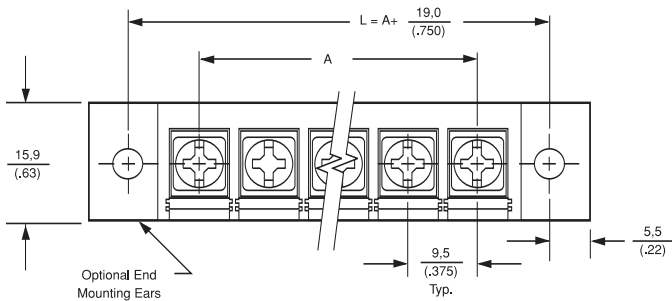

0.375" [9.53] Pitch, Series BC6

Ordering Information

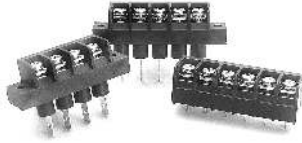

BC6 - P 1 08 - 08

A
B
C
D

Material & Finish

Housing Material—Polypropylene

Flammability—UL94V-0

Color—Black

Terminals—Bright acid tin over copper alloy

Screws—#6-32 steel, zinc plating with clear chromate coating. Wire clamping screws and binding head screws available.

Mechanical Properties

Pitch (Terminal Spacing)—0.375" [.525]

Recommended PCB Hole Dia.—1.8mm [.073"]

Electrical Properties

Ratings—UL Class C 20 Amps, 300V
 UL Class D 5 Amps, 600V
 CSA Type C 20 Amps, 300V

Wire Range—12-22 AWG

Environmental Properties

Operating Temperature Range—105°C [221°F] max.

Circuit Identification—See page 179

Hardware Options

TC2—Safety covers, see page 174

QC2x—250 Quick connects, see page 176

QC4x—187 Quick connects, see page 176

ST80—Single sided solder tabs, see page 176

1437661-7—Retaining clip, Insulating turret, see page 178

J6—Jumpers, see page 177

1437651-2—Wire clamp screw, steel, see page 178

1437651-5—Wire clamp screw, brass, see page 178

1437651-8—Binding head screw, steel, see page 178

L03—Binding head screw, stainless, see page 178

A Terminal Style

P=Printed Circuit (available with 1,2,5 block style only)

T=Solder Turret

Q=Quick Connect .250

W=Solderless Wrap

E=Extended Circuit Board

F=Quick Connect .187

B Block Style

1=Flat, all positions filled (standard)

2=Flat, end mounting ears with holes (required for cover option)

3=Insulating turret, end mounting ears with holes (required for cover option)

4=Insulating turret, all positions filled

5=Flat, end positions open with mounting bushings

6=Insulating turret, end positions open with mounting bushings

C Screw Hardware

07=Steel binding combo head screw

08=Steel wire-clamp combo head screw (standard)

05=Brass binding combo head screw

06=Brass wire-clamp combo head screw

D No. of Circuits (Not Positions)

02 to 25 circuits

Note: All part numbers are RoHS Compliant.

0.375" [9.53] Pitch, Series MB6, Double Level

MB6-P108-##



Material & Finish

Housing Material—Thermoplastic polyamide

Flammability—UL94V-0

Color—Black

Terminals—Bright acid tin over copper alloy

Screws—#6-32 steel, zinc plating with clear chromate coating.

Mechanical Properties

Pitch (Terminal Spacing)—.375" [9.525]

Recommended PCB Hole Dia.—1.8mm [.073"]

Electrical Properties

Ratings—UL Class C 25 Amps, 300V
CSA Type C 25 Amps, 600V

Wire Range—12-22 AWG

Environmental Properties

Operating Temperature Range—105°C [221°F] max.

Hardware Options

1437651-2—Wire clamp screw, see page 178

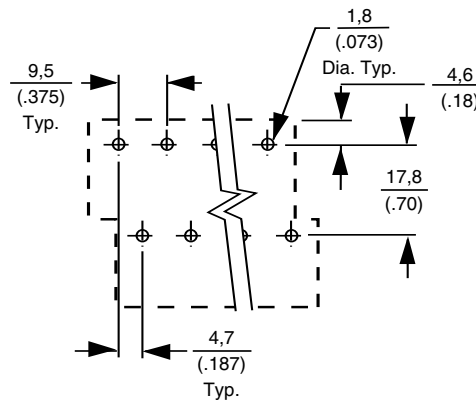

Printed Circuit Board Layout

ORDERING INFORMATION

MB6 - P1 08 - 04

A
 B
 C
 D

- A Series**
MB6=Double Level, 0.375" Centers
- B Terminal Style**
P1=Printed Circuit Pin, Vertical
- C Screw Hardware**
08=Steel wire clamp combo head screws
- D 02 through 40** available in multiples of 2

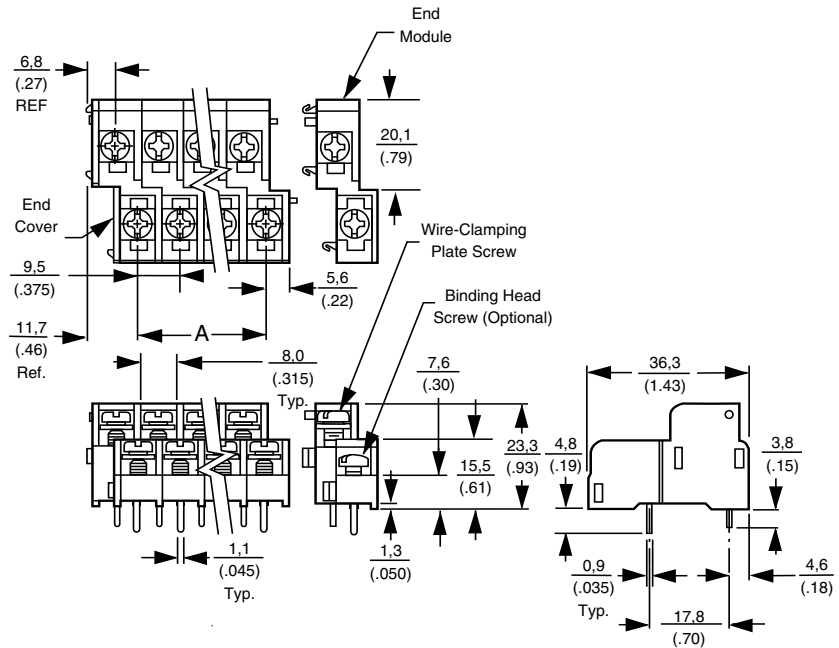

No. of Positions	Dim. A	No. of Positions	Dim. A
4	0.375 [9.5]	24	4.125 [104.8]
6	0.750 [19.1]	26	4.500 [114.3]
8	1.125 [28.6]	28	4.875 [123.8]
10	1.500 [38.1]	30	5.250 [133.3]
12	1.875 [47.6]	32	5.625 [142.9]
14	2.250 [57.1]	34	6.000 [152.4]
16	2.625 [66.7]	36	6.375 [161.9]
18	3.000 [76.2]	38	6.750 [171.4]
20	3.375 [85.7]	*40	7.125 [181.0]
22	3.750 [95.2]		

* Longer lengths available. Please consult Technical Support.



Barrier Strips

2

Note: All part numbers are RoHS Compliant.

0.4375" [11.1] Pitch, Series #8

#8 Series Tri-Barriers

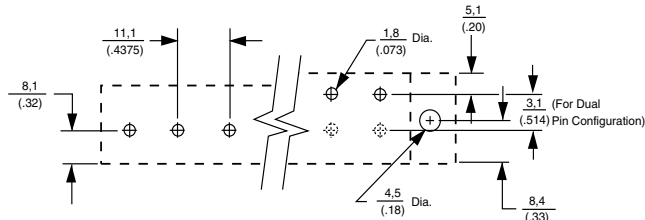

Material & Finish

- Housing Material**—Polypropylene
- Flammability**—UL94V-0
- Color**—Black
- Terminals**—Bright acid tin over copper alloy
- Screws**—#8-32 steel, zinc plating with clear chromate coating. Wire clamping screws and binding head screws with undercut available.

Mechanical Properties

- Pitch (Terminal Spacing)**—0.4375" [11.1]
- Recommended PCB Hole Dia.**—1.8mm [.073"]

Electrical Properties

- Ratings**—UL Class C 30 Amps, 600V
CSA Type C 30 Amps, 600V
- Wire Range**—10-18 AWG (UL)
10-22 AWG (CSA)

Environmental Properties

- Operating Temperature Range**—105°C [221°F] max.

Circuit Identification—See page 179

Hardware Options

- TC8**—Safety covers, see page 174
- QC8**—Quick connects, see page 176
- J8**—Jumpers, see page 177
- 1437425-1**—Wire clamp screw, see page 178
- 1437429-1**—Binding head screw, steel, see page 178

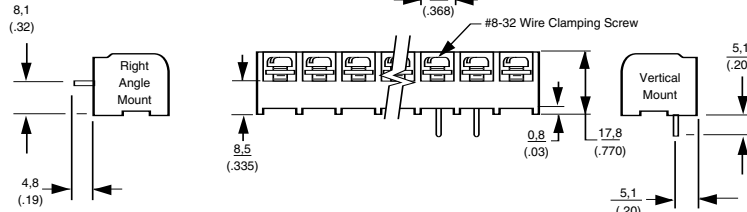
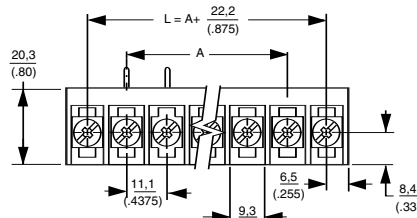
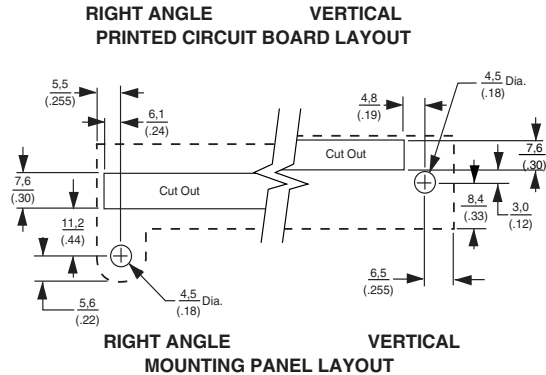

No. of Positions	Dim. A
2	0.4375 [11.1]
3	0.87 [22.2]
4	1.31 [33.3]
5	1.75 [44.5]
6	2.19 [55.6]
7	2.62 [66.7]
8	3.06 [77.8]
9	3.50 [88.9]
10	3.93 [100.0]
11	4.37 [111.1]
12	4.81 [122.2]
13	5.25 [133.3]
14	5.69 [144.5]

No. of Positions	Dim. A
15	6.12 [155.6]
16	6.56 [166.7]
17	7.00 [177.8]
18	7.44 [188.9]
19	7.87 [200.0]
20	8.31 [211.1]
21	8.75 [222.2]
22	9.19 [233.4]
23	9.62 [244.5]
24	10.06 [255.6]
25	10.50 [266.7]
26	10.94 [277.8]



0.4375" [11.1] Pitch, Series #8 (Continued)

Ordering Information

8 PCV-04-006

A **B** **C** **D**

A Screw Size Spacing

8 = #8-32 on .4375" Centers

C No. of Circuits (Not positions)

02 through 26

B Terminal Style

- DBL** = Double Printed Circuit Pin
- PCR** = Printed Circuit, Right Angle
- PCV** = Printed Circuit Pin, Vertical
- QCR** = Quick Connect Tab, Right Angle
- QCV** = Quick Connect Tab, Vertical
- STR** = Solder Turret, Right Angle
- STV** = Solder Turret, Vertical
- TBV** = Non Feed Thru
- WWR** = Solderless Wire Wrap, Right Angle
- WWV** = Solderless Wire Wrap, Vertical

D Modifiers

- Use table below.
- 002=-006 except brass screw
- 003=-007 except brass screw

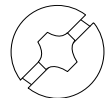

Phil-slot Head

Terminal Style	Modifier Phil-slot Head	Screw Style	Mounting Construction
DBL	006	Wire Clamp	No Mounting
	007	Binding Head	
PCV	006	Wire Clamp	No Mounting
	007	Binding Head	
	008	Wire Clamp	
	009	Binding Head	
PCR	006	Wire Clamp	
	007	Binding Head	
	008	Wire Clamp	
	009	Binding Head	
QCV	006	Wire Clamp	
STV		Wire Clamp	
WWV		Wire Clamp	
QCR	006	Wire Clamp	
STR		Wire Clamp	
WWR		Wire Clamp	
TBV	006	Wire Clamp	



Note: All part numbers are RoHS Compliant.

0.4375" [11.1] Pitch, Series #8 (Continued)

Printed Circuit Pin

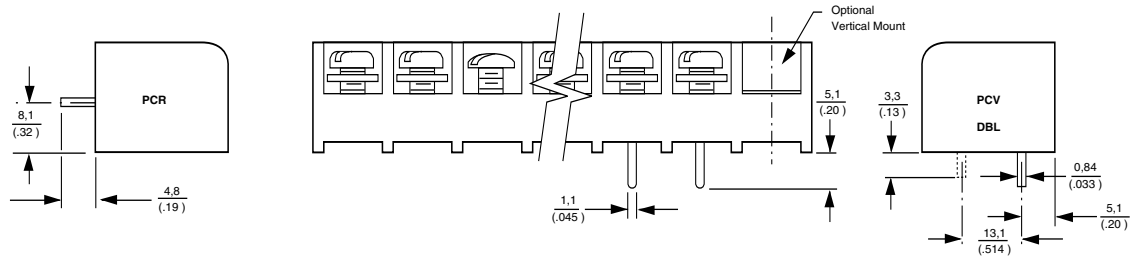

Solder Turret

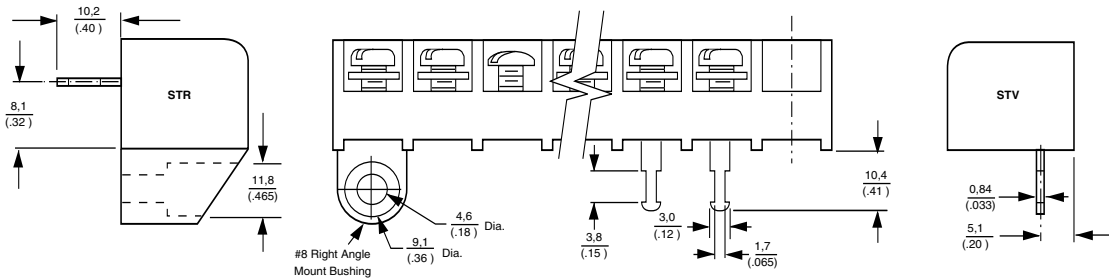

Wire Wrap

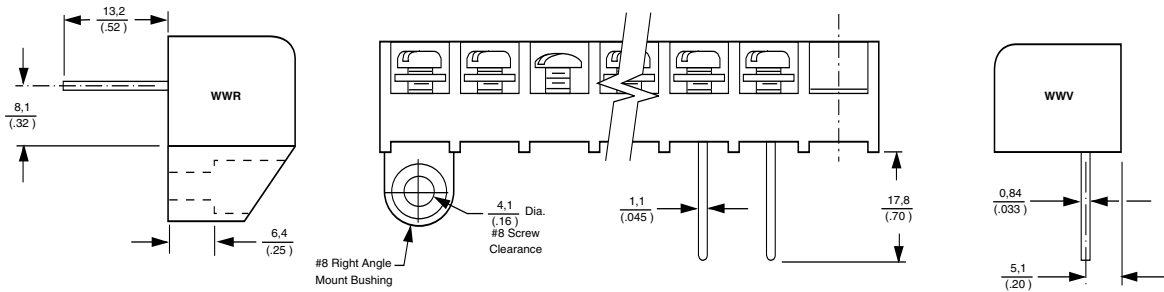

Quick Connect

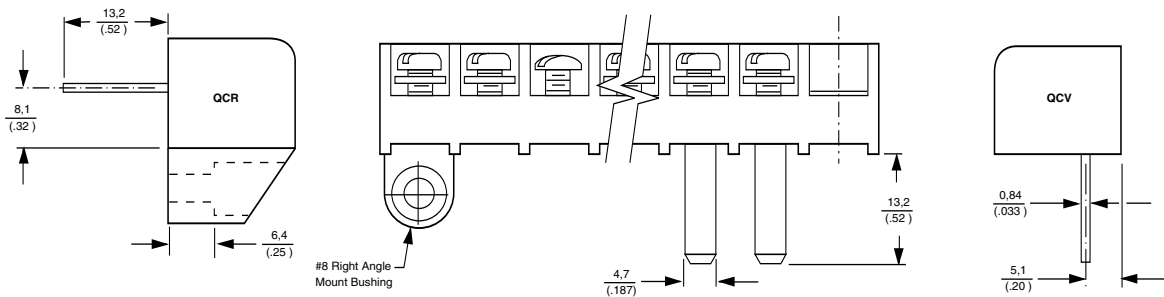

Non-Feed Thru

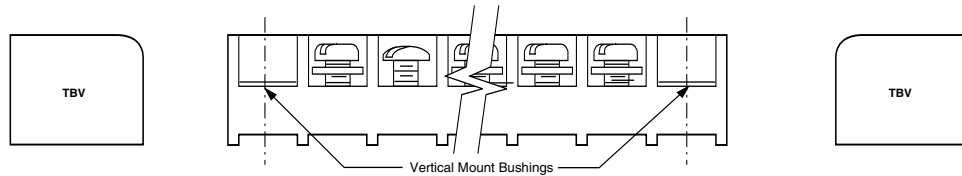

Dual-Barrier Strips

Product Facts

- Industrial controls and automation
- Machine tools
- HVAC/R
- Power supplies
- Security/Irrigation
- Transformers

Design Advantages

- Fast wiring – backed-out wire-ready screws
- Interrupted thread designed to prevent screws from falling out
- Standoffs allow flux and solvents to drain during cleaning
- Molded-to-length or cut-to-length versions available

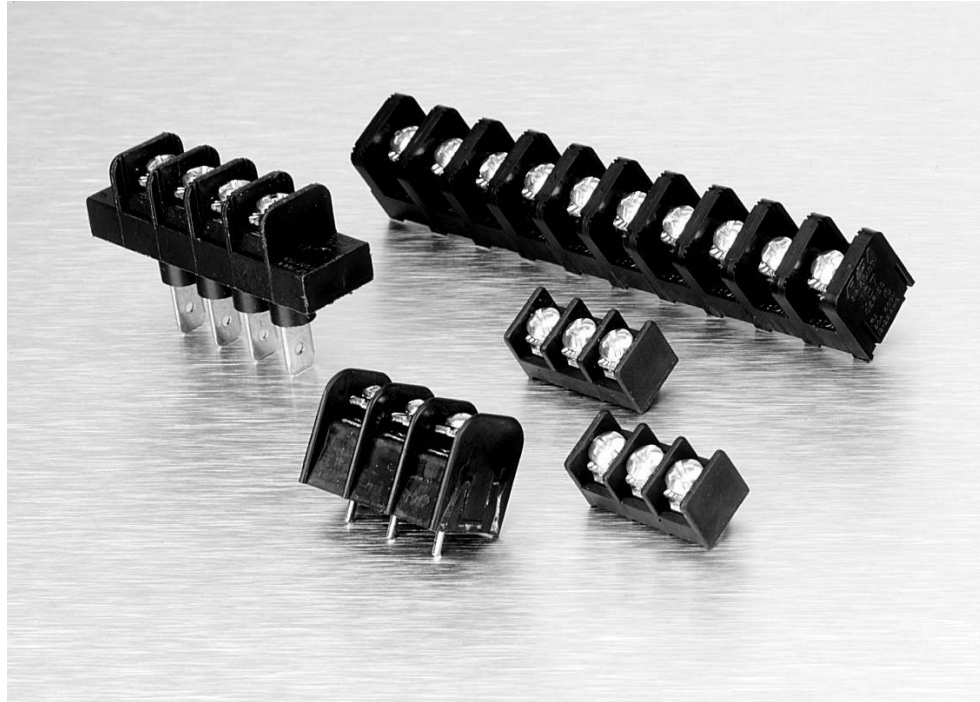

The Dual-Barrier design provides a more cost-effective solution than the Tri-Barrier Strips while still supplying many of the design advantages.

Connector Index

Single Row

0.250" Pitch, Series 1546657	141, 142
0.325" Pitch, Series 4DB	143-144
0.325" Pitch, High Rise	145-146
0.325" Pitch, Series SSB3.....	168-170
0.375" Pitch, Series JC6	147, 148
0.375" Pitch, Series NC6, Low Profile	149, 150
0.4375" Pitch, Series SSB7.....	151-154

Double Row, Panel Mount

0.374" Pitch	156
0.433" Pitch	157
0.437" Pitch	158
0.563" Pitch	160

Note: All part numbers
are RoHS Compliant.

Engineering Notes



High-Density, Dual-Barrier Strips, .250" [6.35] Centerline

Product Facts

- High density accommodates today's compact PCB layouts

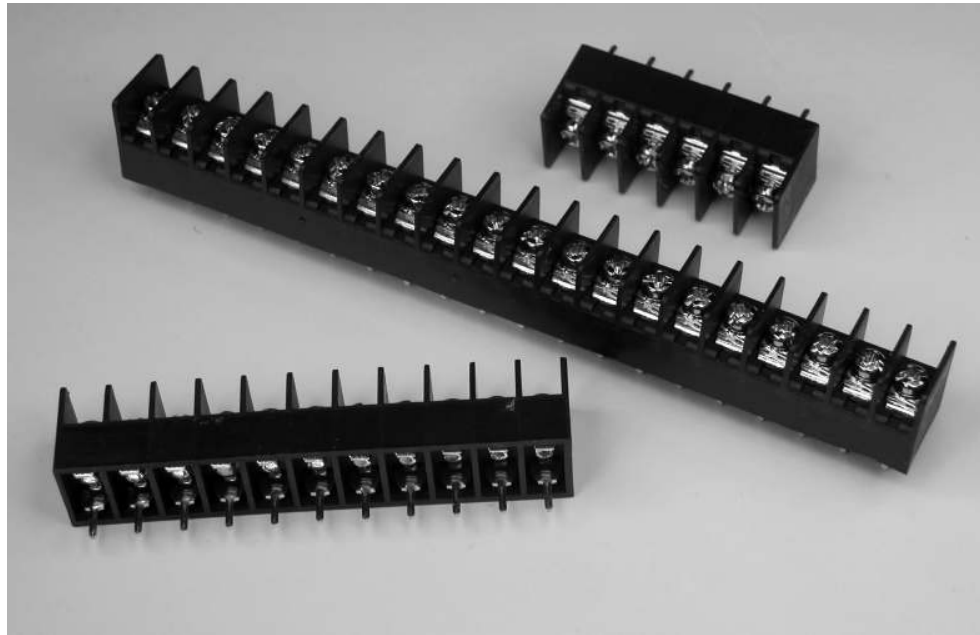

Material & Finish

- Insulator Body**—UL 94V-0 thermoplastic, black
- Terminal**—Brass, tin-plated
- Screw**—M3, Steel, nickel-plated

Mechanical Properties

- Recommended Tightening Torque**—10 in-lbs
- Combination drive screws with #2 Phillips recess and standard slot

Electrical Properties

- Current Rating**—10 A
- Voltage Rating**—300 VAC/DC per UL and CSA standards
- Wire Range**—16-30 AWG Copper, Solid or Stranded

Environmental Properties

- Operating Temperature**—40°F to +221°F [-40°C to +115°C]
- Circuit Identification**—See page 179

Hardware Options

- TC8**—Safety cover, see page 174
- QC8**—Quick connects, see page 176
- J8**—Jumpers, see page 177
- 1437425-1**—Wire clamp screw, see page 178
- 1437429-1**—Binding head screw, steel, see page 178



High-Density, Dual-Barrier Strips, .250" [6.35] Centerline (Continued)

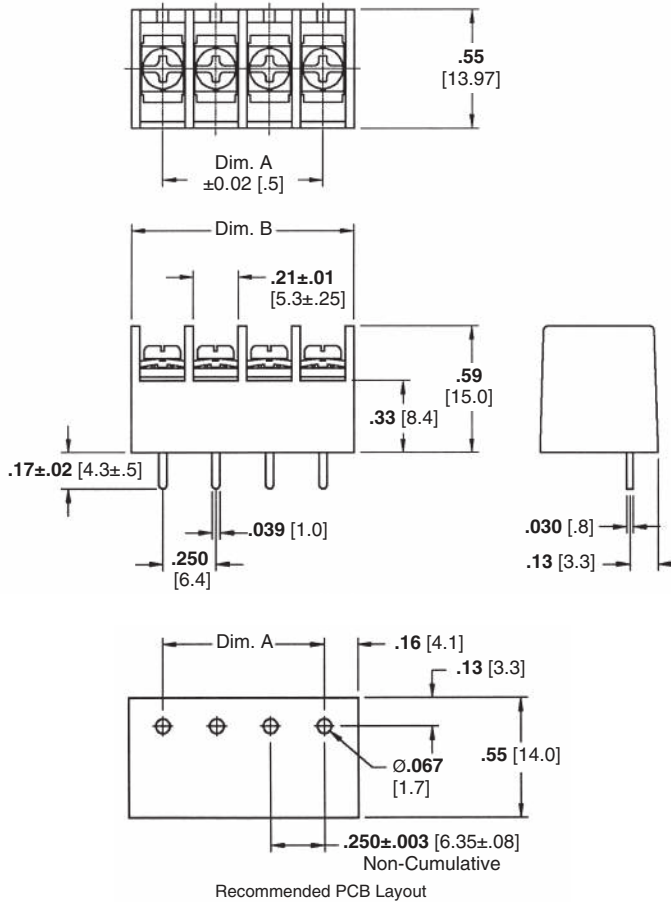

No. of Positions	Dimension		Part Number
	A	B	
2	0.250 [6.35]	0.54 [13.7]	1546657-2
3	0.500 [12.7]	0.79 [20.1]	1546657-3
4	0.750 [19.1]	1.04 [26.4]	1546657-4
5	1.000 [25.4]	1.29 [32.8]	1546657-5
6	1.250 [31.8]	1.54 [39.1]	1546657-6
7	1.500 [38.1]	1.79 [45.5]	1546657-7
8	1.750 [44.4]	2.04 [51.8]	1546657-8
9	2.000 [50.8]	2.29 [58.2]	1546657-9
10	2.250 [57.2]	2.54 [64.5]	1-1546657-0
11	2.500 [63.5]	2.79 [70.9]	1-1546657-1
12	2.750 [69.9]	3.04 [77.2]	1-1546657-2
13	3.000 [76.2]	3.29 [83.6]	1-1546657-3
14	3.250 [82.6]	3.54 [90.0]	1-1546657-4
15	3.500 [88.9]	3.79 [96.3]	1-1546657-5

No. of Positions	Dimension		Part Number
	A	B	
16	3.750 [95.3]	4.04 [102.6]	1-1546657-6
17	4.000 [101.6]	4.29 [108.9]	1-1546657-7
18	4.250 [107.9]	4.54 [115.3]	1-1546657-8
19	4.500 [114.3]	4.79 [121.7]	1-1546657-9
20	4.750 [120.6]	5.04 [128.0]	2-1546657-0
21	5.000 [127.0]	5.29 [134.4]	2-1546657-1
22	5.250 [133.3]	5.54 [140.7]	2-1546657-2
23	5.500 [139.7]	5.79 [147.1]	2-1546657-3
24	5.750 [146.1]	6.04 [153.4]	2-1546657-4
25	6.000 [152.4]	6.29 [159.8]	2-1546657-5
26	6.250 [158.8]	6.54 [166.1]	2-1546657-6
27	6.500 [165.1]	6.79 [172.5]	2-1546657-7
28	6.750 [171.5]	7.04 [178.8]	2-1546657-8
29	7.000 [177.8]	7.29 [185.2]	2-1546657-9
30	7.250 [184.2]	7.54 [191.5]	3-1546657-0

0.325" [8.26] Pitch, Series 4DB

4DB-P108-##

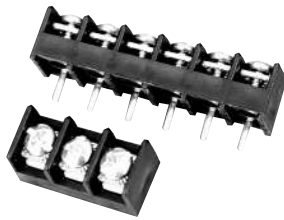

Material & Finish

Housing Material—Thermoplastic Polyamide

Flammability—UL94V-0

Color—Black

Terminals—Bright acid-tin over copper alloy

Screws—#6-32 steel, zinc plating with clear chromate coating. Wire clamping screws and binding head screws available.

Mechanical Properties

Pitch (Terminal Spacing)—0.325" [9.525]

Recommended PCB Hole Dia.—1.7mm [0.07"]

Electrical Properties

Ratings—UL Class C 20 Amps, 150V
 UL Class D 10 Amps, 300V
 CSA Type B 20 Amps, 300V
 CSA Type C 20 Amps, 300V
 CSA Type D 10 Amps, 300V
 CSA Type E 20 Amps, 300V

Wire Range—12-22 AWG

Environmental Properties

Operating Temperature Range—105°C [221°F] max.

Circuit Identification—See page 179

Hardware Options

QC4—Quick connects, see page 176

J4—Jumpers, see page 177

9-1437667-9—Wire clamp screw, see page 178

Ordering Information

4DB - P 1 08 - 06

A **B** **C** **D** **E**

- A Series**
4DB = Dual-Barrier, 0.325" Centers
- B Terminal Style**
P = Printed Circuit Pin
W = Wire Wrap
R = Right Angle
- C Block Style**
1 = Flat, all positions filled
2 = Flat, end mounting holes
- D Screw Type**
07 = Steel binding combo head screws
08 = Steel wire clamp combo head screws
- E No. of Circuits (Not Positions)**
02 through 30



Note: All part numbers are RoHS Compliant.

0.325" [8.26] Pitch, Series 4DB (Continued)

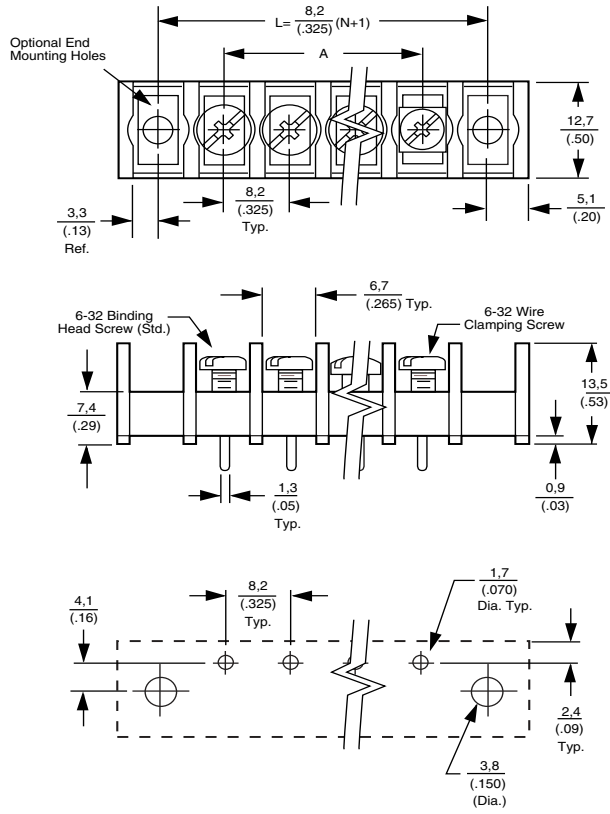

PRINTED CIRCUIT BOARD LAYOUT

Bend Options:

A variety of bend options are available. Please consult Technical Support for details.

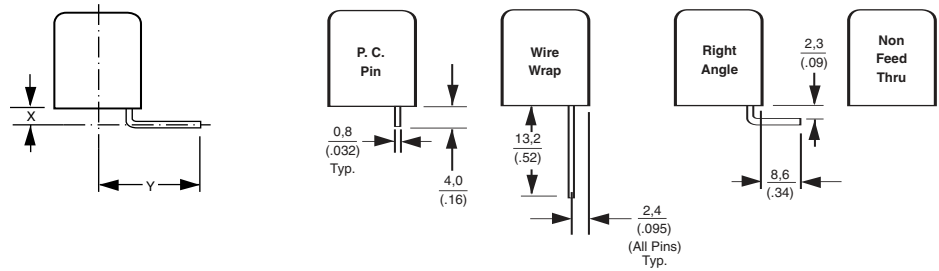

No. of Positions	Dim. A	No. of Positions	Dim. A
2	0.325 [8.2]	17	5.200 [132.1]
3	0.650 [16.5]	18	5.525 [140.3]
4	0.975 [24.8]	19	5.850 [148.6]
5	1.300 [33.0]	20	6.175 [156.8]
6	1.625 [41.3]	21	6.500 [165.1]
7	1.950 [49.5]	22	6.825 [173.3]
8	2.275 [57.8]	23	7.150 [181.6]
9	2.600 [66.0]	24	7.475 [190.0]
10	2.925 [74.3]	25	7.800 [198.1]
11	3.250 [82.5]	26	8.125 [206.4]
12	3.575 [90.8]	27	8.450 [214.6]
13	3.900 [99.1]	28	8.775 [222.8]
14	4.225 [107.3]	29	9.100 [231.1]
15	4.550 [115.6]	30	9.425 [239.4]
16	4.875 [123.8]		



High Rise Dual-Barrier Strips, .325 [8.26] Centerline

Product Facts

- High rise profile provides wire entry access on congested PC boards
- Space saving high rise design allows for dual-level wire entry when used with 4DB series barrier strips
- Captive screws provided in wire-ready position

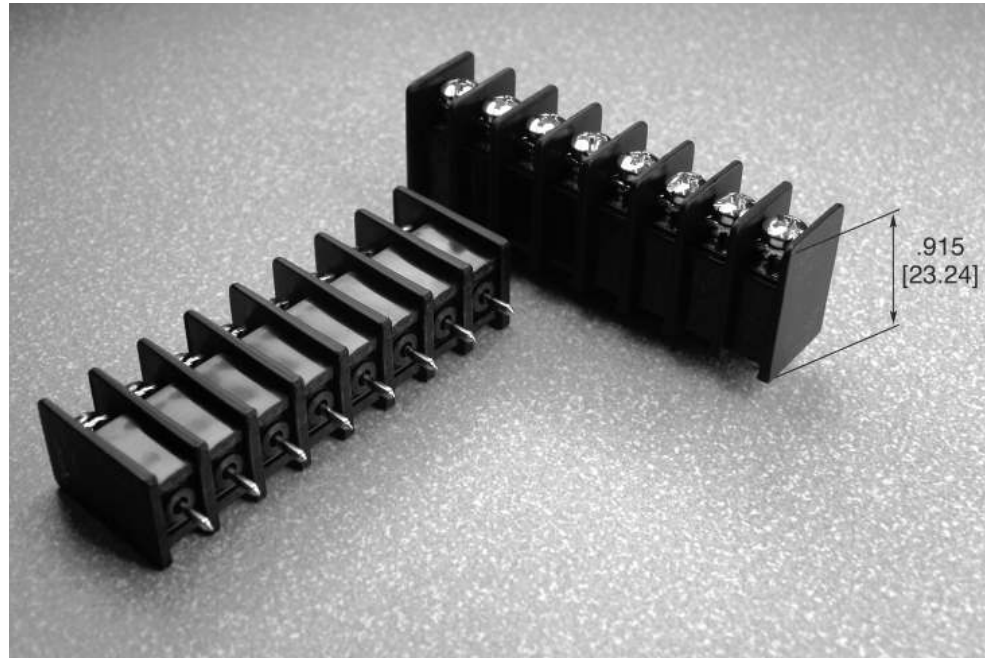

Material & Finish

Insulator Body—UL 94V-0 Thermoplastic, Black

Terminal—Brass, Tin plated

Mechanical Properties

Recommended Tightening

Torque—10 in-lbs

Combination drive screws with #2 Phillips Recess and Standard Slot

Electrical Properties

Current Rating—10 A

Voltage Rating—20 A, 300 VAC/DC per UL and CSA standards

Wire Range—12-22 AWG Cu, Solid or Stranded

Environmental Properties

Operating Temperature—40°F to +221°F [-40°C to +105°C]

Circuit Identification—See page 179

Hardware Options

J4—Jumpers, see page 177

Note: All part numbers are RoHS Compliant.

High Rise Dual-Barrier Strips, .325 [8.26] Centerline (Continued)

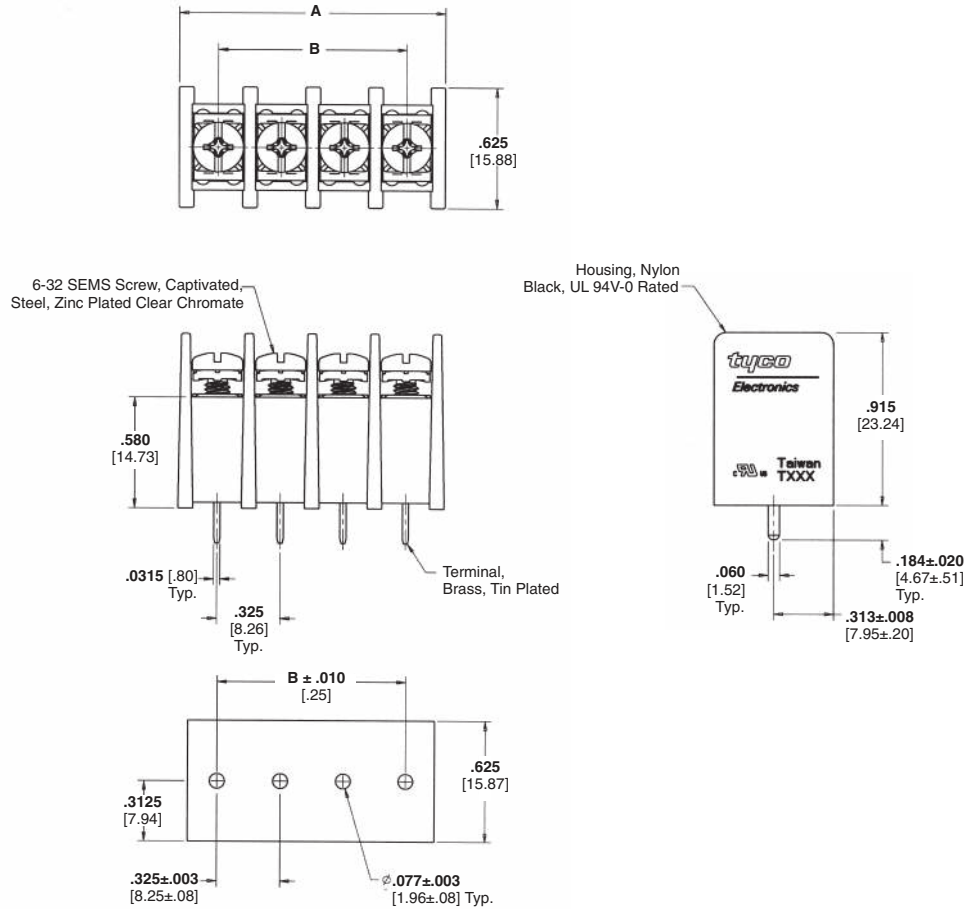

Recommended PC Board Layout

No of Positions	Dimension		Part Number
	A	B	
2	0.725 [18.42]	0.325 [8.26]	1546734-2
3	1.050 [26.67]	0.650 [16.51]	1546734-3
4	1.375 [34.93]	0.975 [24.77]	1546734-4
5	1.700 [43.18]	1.300 [33.02]	1546734-5
6	2.025 [51.44]	1.625 [41.28]	1546734-6
7	2.350 [59.69]	1.950 [49.53]	1546734-7
8	2.675 [67.95]	2.275 [57.79]	1546734-8
9	3.000 [76.20]	2.600 [66.04]	1546734-9
10	3.325 [84.46]	2.925 [74.29]	1-1546734-0
11	3.650 [92.71]	3.250 [82.55]	1-1546734-1
12	3.975 [100.97]	3.575 [90.81]	1-1546734-2
13	4.300 [109.22]	3.900 [99.06]	1-1546734-3
14	4.625 [117.48]	4.225 [107.32]	1-1546734-4
15	4.950 [125.73]	4.550 [115.57]	1-1546734-5
16	5.275 [133.99]	4.875 [123.83]	1-1546734-6



0.375" [9.53] Pitch, Series JC6

JC6-P107-03

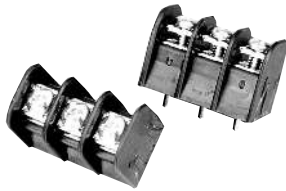

Material & Finish

Housing Material—Polypropylene

Flammability—UL94V-0

Color—Black

Terminals—Bright acid-tin over copper alloy

Screws—#6-32 steel, zinc plating with clear chromate coating. Wire clamping screws and binding head screws available.

Mechanical Properties

Pitch (Terminal Spacing)—0.375" [9.525]

Recommended PCB Hole Dia.—1.8mm [.073"]

Electrical Properties

Ratings—UL Class C 20 Amps, 300V
 UL Class D 5 Amps, 600V
 CSA Type B 20 Amps, 300V
 CSA Type C 20 Amps, 300V
 CSA Type D 5 Amps, 600V
 CSA Type E 20 Amps, 600V

Wire Range—12-22 AWG

Environmental Properties

Operating Temperature Range—105°C [221°F] max.

Circuit Identification—See page 179

Hardware Options

TC9—Safety cover, see page 174

QC2x—.250 Quick connects, see page 176

QC4x—.187 Quick connects, see page 176

J6—Jumpers, see page 177

J7x—Over-the-barrier jumpers, see page 177

1437661-7—Retaining clips, insulating turrets, see page 178

1437651-2—Wire clamp screw, steel, see page 178

1437651-5—Wire clamp screw, brass, see page 178

1437651-8—Binding head screw, steel, see page 178

L03—Binding head screw, stainless, see page 178

Ordering Information

JC6 - P 1 07 - 06

A **B** **C** **D** **E**

A Series

JC6 = Dual-Barrier, 0.375" Centers

B Terminal Style

C = Non Feed Thru

E = Extended Circ. Bd.

F = Quick Connect, .187

P = Printed Circuit Pin (available with 1, 2 Block Style)

T = Solder Turret

Q = Quick Connect, .250

W = Solderless Wrap

C Block Style

1 = Flat, all positions filled

2 = Flat, end mounting ears (required for cover option)

3 = Insulating turret, end mounting ears with holes (required for cover option)

4 = Insulating turret, all positions filled

5 = Flat, open end with mounting bracket

6 = Flat, open end, mounting bracket, insulating turret

7 = Closed bottom, end mounting ears. (for C style terminal only)

D Screw Hardware

05 = Brass binding combo head screws

06 = Brass wire-clamp combo head screws

07 = Steel binding combo head screws

08 = Steel wire-clamp combo head screws (standard)

E No. of Circuits (Not positions)

02 through 25



LR30811



E54800

Note: All part numbers are RoHS Compliant.

0.375" [9.53] Pitch, Series JC6 (Continued)

No. of Positions	Dim. A
2	0.325 [8.2]
2	0.375 [9.5]
3	0.750 [19.1]
4	1.125 [28.6]
5	1.500 [38.1]
6	1.875 [47.6]
7	2.250 [57.1]
8	2.625 [66.7]
9	3.000 [76.2]
10	3.375 [85.7]
11	3.750 [95.2]
12	4.125 [104.8]
13	4.500 [114.3]

No. of Positions	Dim. A
14	4.875 [123.8]
15	5.250 [133.3]
16	5.625 [142.9]
17	6.000 [152.4]
18	6.375 [161.9]
19	6.750 [171.45]
20	7.125 [180.98]
21	7.500 [190.5]
22	7.875 [200.03]
23	8.250 [209.55]
*24	8.625 [219.08]
*25	9.000 [228.60]

* No mounting available

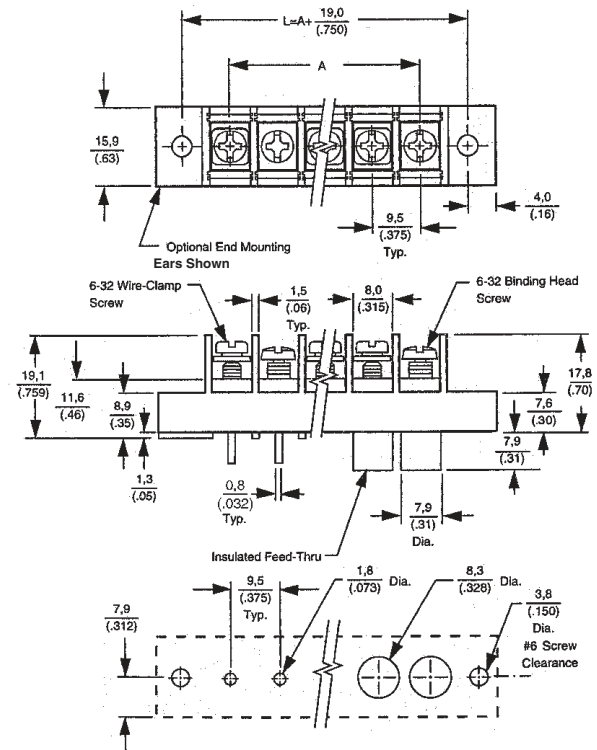

PRINTED CIRCUIT BOARD/MOUNTING PANEL LAYOUT

Bend Options

A variety of bend styles are available. Please consult Technical Support for details.

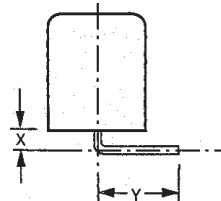

Available Block Styles: 1/2/5

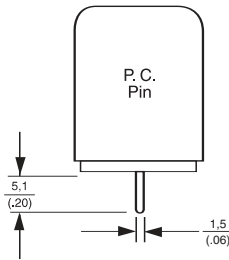

Available Block Styles: 2/3/4/5/6

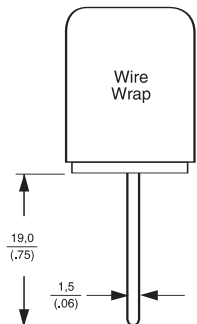

Available Block Styles: 2/3/4/5/6

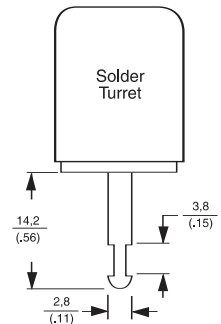

Available Block Styles: 2/3/4

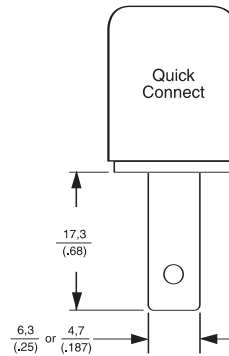

Available Block Styles: 1/2/3/4/5/6

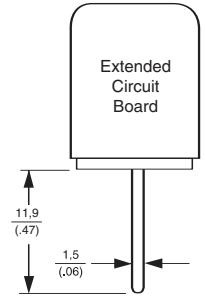

Available Block Styles: 7

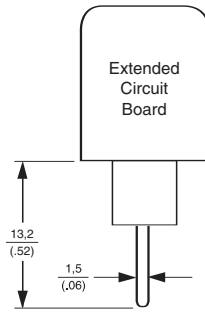
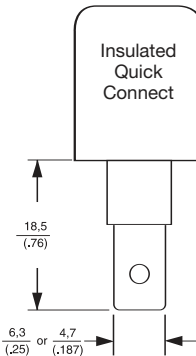
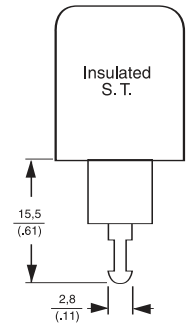
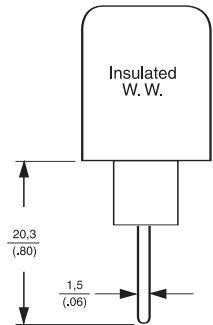
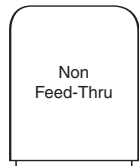

LR30811 E54800

Note: All part numbers are RoHS Compliant.

0.375" [9.53] Pitch, NC6 Series, Low Profile

NC6-P108-03

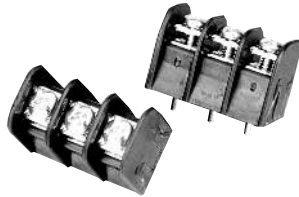

Material & Finish

Housing Material—Thermoplastic polyamide

Flammability—UL94V-0

Color—Black

Terminals—Bright acid tin over copper alloy

Screws—#6-32 steel, zinc plating with clear chromate coating. Wire clamping screws and binding head screws available.

Mechanical Properties

Pitch (Terminal Spacing)—
.375" [9.525]

Screw Size—#6-32 steel

Recommended PCB Hole Dia.—
1.8mm [.073"] dia.

Electrical Properties

Ratings—UL Class C 20 Amps, 300V
CSA Type C 20 Amps, 300V

Wire Range—12-22 AWG

Environmental Properties

Operating Temperature Range—
105°C [221°] max.

Circuit Identification—See page 179

Hardware Options

1437651-2—Wire clamp screw, steel, see page 178

1437651-5—Wire clamp screw, brass, see page 178

1437651-8—Binding head screw, steel, see page 178

L03—Binding head screw, stainless, see page 178

Ordering Information

NC6 - P 1 08- 04

A B C D E

A Series
NC6 = Dual-Barrier, 0.375" Centers, Low Profile

B Terminal Style
P = Printed Circuit Pin

C Block Style
1 = Flat, all positions filled
2 = End mounting holes provided

D Screw Hardware
05 = Brass binding combo head screws
06 = Brass wire-clamp combo head screws
07 = Steel binding combo head screws
08 = Steel wire-clamp combo head screws

E No. of Circuits (Not positions)
02 through 24

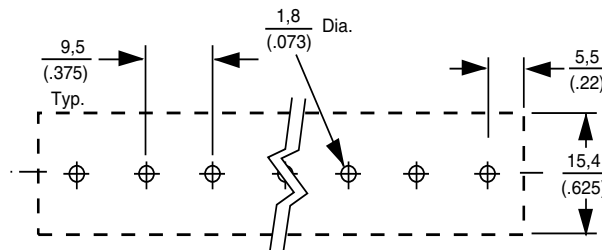

RECOMMENDED PCB HOLE LAYOUT

Note: All part numbers are RoHS Compliant.

0.375" [9.53] Pitch, NC6 Series, Low Profile (Continued)

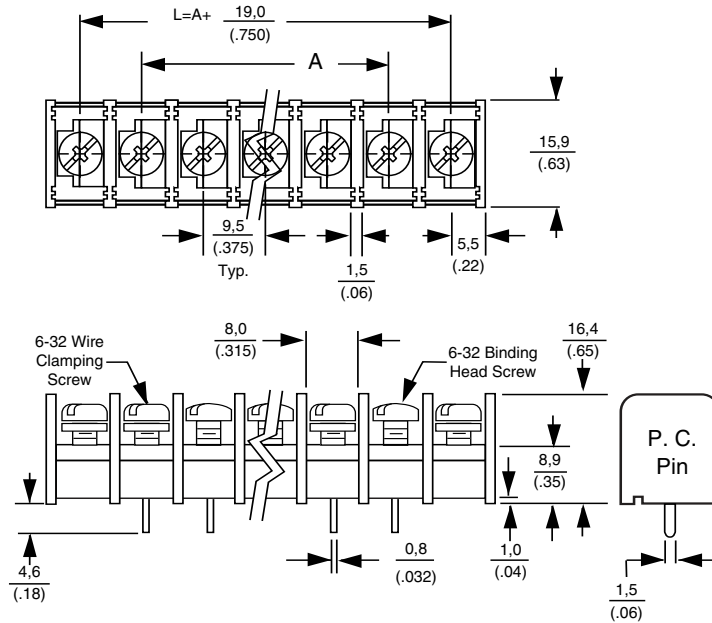

No. of Positions	Dim. A	No. of Positions	Dim. A
2	0.375 [9.5]	14	4.875 [123.8]
3	0.750 [19.1]	15	5.250 [133.3]
4	1.125 [28.6]	16	5.625 [142.9]
5	1.500 [38.1]	17	6.000 [152.4]
6	1.875 [47.6]	18	6.375 [161.9]
7	2.250 [57.1]	19	6.750 [161.9]
8	2.625 [66.7]	20	7.125 [171.4]
9	3.000 [76.2]	21	7.500 [181.0]
10	3.375 [85.7]	22	7.875 [190.5]
11	3.750 [95.2]	*23	8.250 [200.0]
12	4.125 [104.8]	*24	8.625 [209.6]
13	4.500 [114.3]		

* No mounting available

Note: All part numbers are RoHS Compliant.

0.4375" [11.1] Pitch, Series SSB7

SSB7FP##0202

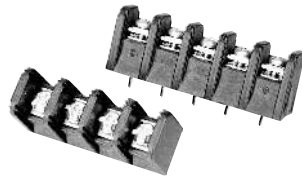

Material & Finish

- Housing Material**—Polypropylene
- Flammability**—UL94V-2
- Color**—Black
- Terminals**—Brass, bright acid tin over copper plating
- Screw**—#6-32 Steel with zinc + chromate plating

Mechanical Properties

- Pitch (Terminal Spacing)**—
.4375 in. [11.1]
- Recommended PCB Hole Dia.**—
.077" [1.955]
- Wire Strip Length**—
.38" [9.652]
- Recommended Tightening Torque**—
8 in.-lbs.
- Recommended Screwdrivers**—
Stanley 1006-4, Sears Craftsman 41581, Any #2 Phillips-Head
- Wire Lug Width (Max.)**—
8.1mm [0.320 in.]

Electrical Properties

- Ratings**—UL Class B 20 Amps, 600V
UL Class C 20 Amps, 600V
CSA Type C 20 Amps, 300V
CSA Type D, 5 Amps, 600V

- Wire Range**—12-22 AWG
- Dielectric Withstand**—5000V

Environmental Properties

- Operating Temperature Range**—
60°C to +105°C [-76°F to +221°F]

Computing Barrier Block Lengths

- Direct Mounting**—Use C1 and L1 for P & H mounting options
- End Position Mounting**—Use L2 and C2 for M, E, F & G mounting options

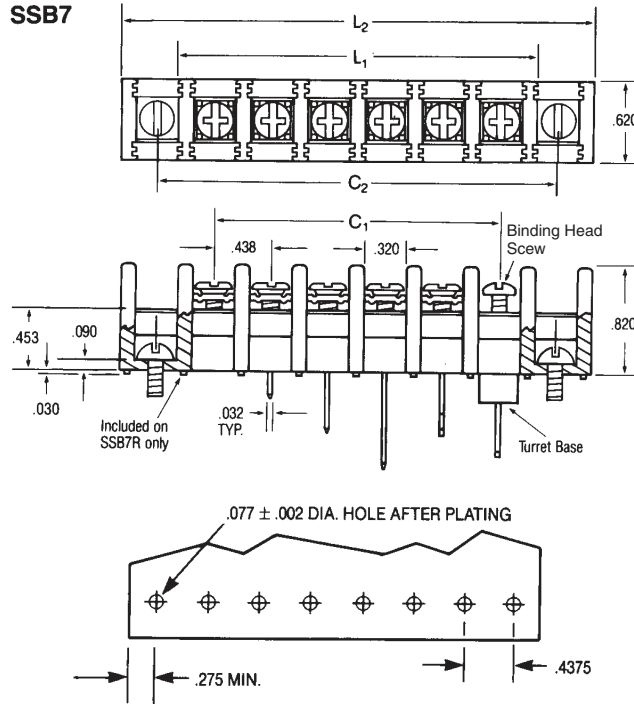

Circuits (not positions)	C1 in.	L1* in.	C2 in.	L2* in.
01	—	—	0.88	1.44
02	0.44	1.00	1.31	1.88
03	0.88	1.44	1.75	2.31
04	1.31	1.88	2.19	2.75
05	1.75	2.31	2.63	3.19
06	2.19	2.75	3.06	3.63
07	2.63	3.19	3.50	4.06
08	3.06	3.63	3.94	4.50
09	3.50	4.06	4.38	4.94
10	3.94	4.50	4.81	5.38
11	4.38	4.94	5.25	5.81
12	4.81	5.38	5.69	6.25
13	5.25	5.81	6.13	6.69
14	5.69	6.25	6.56	7.13
15	6.13	6.69	7.00	7.56
16	6.56	7.13	7.44	8.00
17	7.00	7.56	7.88	8.44
18	7.44	8.00	8.31	8.88
19	7.88	8.44	8.75	9.31
20	8.31	8.88	9.19	9.75
21	8.75	9.31	9.63	10.19
22	9.19	9.75	10.06	10.63
23	9.63	10.19	10.50	11.06
24	10.06	10.63	10.94	11.50
25	10.50	11.06	11.38	11.94
26	10.94	11.50	—	—
27	11.38	11.94	—	—



Note: All part numbers are RoHS Compliant.

0.4375" [11.1] Pitch, Series SSB7 (Continued)

Ordering Information

SSB 7 F P 06 02 02 11
A B C D E F G H

- A Single Screw Dual-Barrier Strip SSB**
- B Contact Spacing (Center-to-Center)**
7 = .4375 (7/16)
- C Base Options**
 C=Closed Base
 F=Flat Base
 R=Raised Base
 T=Turret Base
 (Available only with 01, 04, 05, 07, 09, 12, 13, 15 style bottom terminals)
- D Mounting Options**
 (See illustration below)
 E=Open end positions, with mounting inserts, with end barriers
 F=Open end positions, without mounting inserts, without end barriers
 G=Open end positions, with mounting inserts, without end barriers
 M=Open end positions, without mounting inserts, with end barriers
 P=All positions filled with contacts, with end barriers

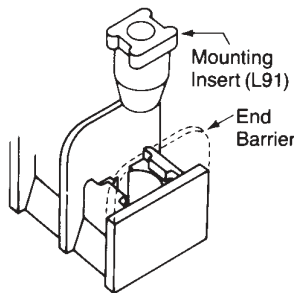

- E No. of Circuits (Not Positions)**
 Must conform to mounting options
02 to 32 circuits (P & H mounting)
02 to 27 circuits (M, E, F & G mounting)
- F Terminal Style**
 01=Solder Tail
 02=Printed Circuit Pin
 03=Non-Feed Through (with C base only)
 04=Extended Printed Circuit Pin
 05=Quick Connects
 06=90° bend, .46" x .11" (with F base only)
 07=Wire Wrap
 08=90° bend, .75" x .11" (with F base only)
 12=90° bend, .21" x .65"
 13=90° bend, .36" x .50"
 14=90° bend, .41" x .16" (with F base only)
 15=90° bend, .51" x .35"
 16=90° bend, .32" x .25" (with F base only)
- G Top Hardware Options**
 00=No top hardware (Separately packaged binding head screws supplied at no cost)
 01=Bright zinc and chromate plated steel binding head screw
 02=Bright zinc and chromate plated steel screw and captive clamp - Do not order with other top hardware
 03=Stainless steel binding head screw
 04=Nickel plated brass binding head screw
 09=Nickel plated brass screw and captive clamp - Do not order with other top hardware

80=Single-sided solder tab
 81=Double-sided solder tab

Quick-Connect Blades
(supplied with 01 screw)

		.250 wide	.187 wide
		x.032	x.020
		thick	thick
20	40		
21	41		
22	42		
23	43		
24	44		
25	45		
26	46		
27	47		
28	48		
29	49		
30	50		
31	51		
32	52		
33	53		
34	54		
35	55		
36	56		

H Circuit Identification Options

11	=	12345...
12	=	...54321
13	=	← 1 2 3 4 5 ...
14	=	... ← 5 4 3 2 1
15	=	12345... ←
16	=	... ← 54321

0.4375" [11.1] Pitch, Series SSB7 (Continued)

Contact Spacing Options:

.4375 in (7/16") Spacing

Extra thick barriers provide higher voltage rating. Up to 27 ckts. (25 circuits for end mounted blocks)

Base Options:

Closed Base

Catalog Letter Code: C. For terminal junction-blocks requiring top connections only. Useful in applications requiring single point circuit terminations or circuit completion via top mounted, single- and two-sided quick-connects. Replace double-row barrier strips.

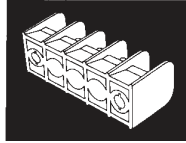

Flat Base

Catalog Letter Code: F. Lends itself most readily to applications where direct top-to-bottom feed-through is required with no special requirement for circuit isolation on the bottom side. The most common example of this is printed circuit board mounting.

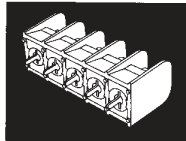

Raised Base

Catalog Letter Code R. Standoffs between each circuit raise block .030" above mounting surface to allow flux and solvents to drain during soldering operations. Available only with 02 and 04 bottom terminals.

Turret Base

Catalog Letter Code: T. Combines top-to-bottom feed-through with bottom-side circuit isolation for panels up to .126" thick. Turret bases are available with the following terminals: solder tail, quick connect, machine wrap, extended circuit board terminal, and right-angle.

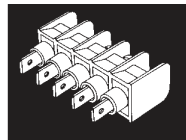

Mounting Options:

End Position Mounting

Catalog Letter Codes: E, F, G or M. Supplied without contacts in end sections to allow installer to mount blocks with screws in end section holes. Base of block will support mounting screws (Codes F & M). Also available with mounting inserts installed in end mounting holes to raise mounting screw heads to the level of other top hardware (Codes E & G).

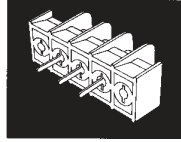

Without End Barriers

Catalog Letter Codes: F, G & H. Facilitates mounting-screw access when end sections are used for mounting.

Direct Mounting

Catalog Letter Codes: P & H. SSBs may be solder-mounted using the bottom terminals themselves, as in the case of printed circuit board applications.

Direct mounting is also possible with turret base models using press-on retaining clips (Catalog No. L97, Part Number 1437661-7) on turrets.

Hardware Options

- 7C1xx**—Safety cover, see page 175
- QC2x**—.250 Quick connects, see page 176
- QC4x**—.187 Quick connects, see page 176
- ST80**—Single sided solder tabs, see page 176
- 1776090-x**—Extra long Quick connects, see page 176
- J7**—Jumpers, see page 177
- L91**—Mounting insert, see page 178
- L92**—Angle bracket, see page 178

Terminal Style:

Solder Tail

Catalog Number Code: 01. For applications requiring a wrapped solder connection.

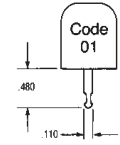

Printed Circuit Pin

Catalog Number Code: 02. Designed specifically for mounting on .063" thick circuit board. Special, readily solderable plating permits good fillet development in automated soldering processes.

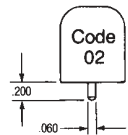

Non-Feed-Through

Catalog Number Code: 03. With closed base option only.



Extended Printed Circuit Pin

Catalog Number Code: 04. Useful where extra length is needed, as in thicker printed circuit boards or single-wrap connections.

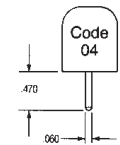

Quick Connect

Catalog Number Code: 05. .250 in. wide x .032" thick blades accept .250" female quick connects.

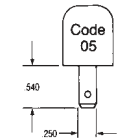

Note: All part numbers are RoHS Compliant.

0.4375" [11.1] Pitch, Series SSB7 (Continued)

**Mounting Position:
Right-Angle**

Catalog Number Codes: 06, 08, 12, 13, 14, 15, 16.

Seven variations of right-angle contacts are available. Designed for circuit board and panel applications, this option saves space when printed circuit boards are stacked closely together. It provides access to top connections in restricted spaces. Mount with angle brackets. (Catalog No. L92).

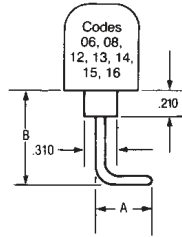

Catalog No. Code	A in.	B in.
06*	0.46	0.11
08*	0.75	0.11
12	0.21	0.65
13	0.36	0.50
14*	0.41	0.16
15	0.51	0.35
16*	0.32	0.25

*Not available with turret base

Wire Wrap

Catalog Number Code: 07.

Longer than extended circuit board terminals. Post alignment is compatible with tolerances required for automatic wire wrapping equipment. Post dimensions are compatible with standard wire wrapping bits.

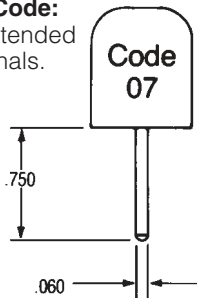

Top Hardware Options:

Binding Head Screws

In most applications, binding head screws will provide excellent wire retention because of exclusive wire locking tabs. These binding head screws are available in 3 materials identified by codes 01, 02, and 03.



Catalog Number Code:

- 01 Bright Zinc and Chromate Plated Steel
- 02 Stainless Steel
- 03 Nickel Plated Brass

Captive Clamp

For applications requiring extra security, captive clamps under the screw heads augment the locking tabs on each contact. Screws have a unique Phil-slot design accepting either Phillips-head or straight screwdriver. Code 02 screw is Bright Zinc and Chromate plated steel. Code 09 screw is Nickel plated Brass.



Catalog Number Code:

- 02 Bright Zinc and Chromate Plated Steel
- 09 Nickel Plated Brass

Catalog Number Codes: 20 through 56.

A complete selection of .187" and .250" quick-connect blades are available for connecting wire terminated with female quick connects. Single and double-sided types in flat, 45° and 90° angle bends can be supplied. Material is brass with tin plating. All blades supplied with 01 screws. Various quick-connects can be combined.

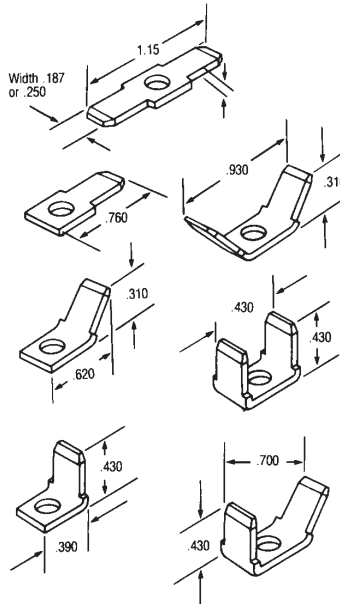

Solder Tabs

Catalog Number Code: 80. Single-sided, slotted solder tabs are available for making wrapped solder connections on the top side of SSBs.

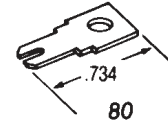

Circuit Identification Options:

Catalog Number Codes: 11 through 16.

SSB blocks may be ordered with circuit identification numbers in white on the molding in six different variations. Custom markings are available on special order.

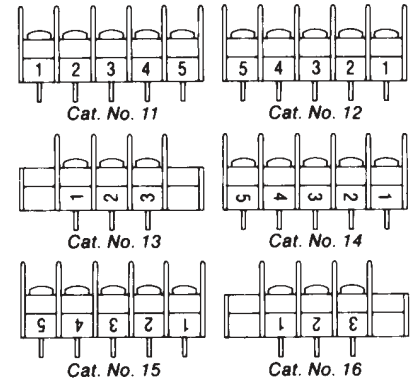

Molding Material Options:

The standard SSB molding material is UL94V-2 polypropylene. Consult Technical Support for other materials available on special order.

Molding Color Options:

SSB blocks are stocked in black. Consult Technical Support for availability of other colors.

Double-Row, Dual-Barrier Strips

Product Facts

- Double-row, dual barrier strips for wire-to-wire applications. These parts also allow end users to complete the wiring to a separate screw without disturbing the factory wiring.
- Available with either binding head screws or wire clamp
- Increased current-carrying capability

Applications

- Industrial Controls
- Test Equipment
- HVAC
- Power Supplies
- Traffic Signals
- Telecom

Key Features

- Closed bottom design allows for mounting direct to sheet metal panel
- Molded to length
- Accessories such as Quick-Connect Tabs and Jumpers available
- Wire-to-wire termination:
 - .374 [9.5] centerline:
Up to 30 positions
 - .433 [11.0] centerline:
Up to 26 positions
 - .437 [11.1] centerline:
Up to 26 positions
 - .563 [14.3] centerline:
Up to 18 positions
- RoHS Compliant

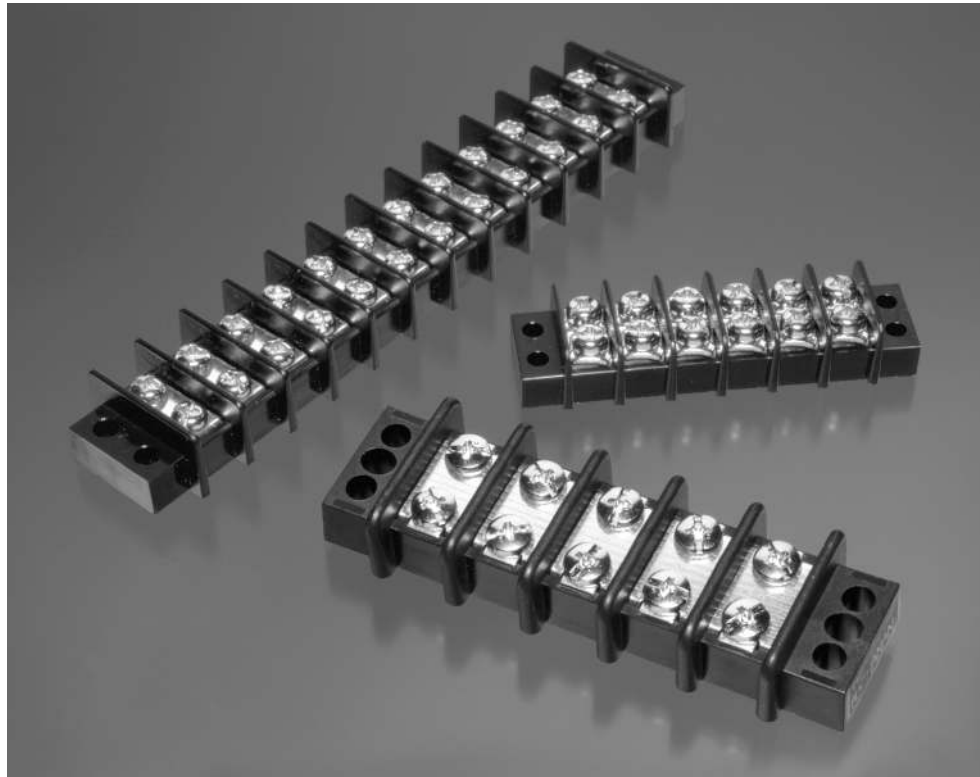

Double-Row, Dual-Barrier Strips (Continued)

.374 [9.5] Centerline

Material & Finish

Insulator Body—UL94V-0, thermoplastic, black

Terminals—Brass, tin plated

Screw—#6-32 steel, nickel plated

Mechanical Properties

Screw Torque—12 in-lb

Electrical Properties

Current Rating—20 A, 300 VAC

Wire Range—12-22 AWG

Withstanding Voltage—2000 VAC min.

Environmental Properties

Operating Temperature—
-40°F to +221°F [-40°C to +120°C]

Hardware Options

J6140—Spade jumper, see page 177

J6240—Flanged spade jumper, see page 177

J6340—Ring tongue jumper, see page 177

J6—Spade jumper, see page 177

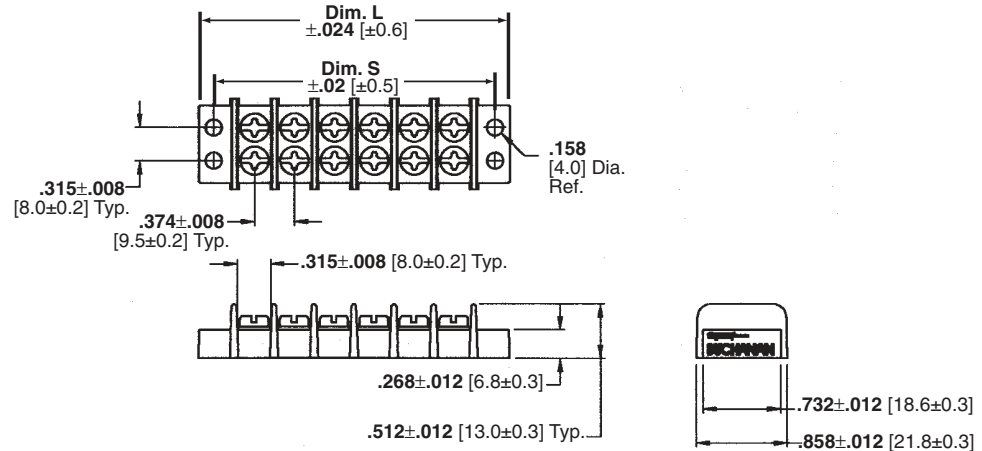

No. of Positions	Dimension		Part Numbers	
	L	S	w/Binding Head Screws	w/Wire Clamp Screws
2	1.42 [036.2]	1.13 [028.7]	1546306-2	1546307-2
3	1.80 [045.7]	1.50 [038.2]	1546306-3	1546307-3
4	2.17 [055.2]	1.88 [047.7]	1546306-4	1546307-4
5	2.55 [064.7]	2.25 [057.2]	1546306-5	1546307-5
6	2.92 [074.2]	2.63 [066.7]	1546306-6	1546307-6
7	3.30 [083.7]	3.00 [076.2]	1546306-7	1546307-7
8	3.67 [093.2]	3.37 [085.7]	1546306-8	1546307-8
9	4.05 [103.0]	3.75 [095.2]	1546306-9	1546307-9
10	4.41 [112.0]	4.13 [105.0]	1-1546306-0	1-1546307-0
11	4.80 [122.0]	4.49 [114.0]	1-1546306-1	1-1546307-1
12	5.16 [131.0]	4.88 [124.0]	1-1546306-2	1-1546307-2
13	5.55 [141.0]	5.24 [133.0]	1-1546306-3	1-1546307-3
14	5.91 [150.0]	5.63 [143.0]	1-1546306-4	1-1546307-4
15	6.30 [160.0]	5.98 [152.0]	1-1546306-5	1-1546307-5
16	6.65 [169.0]	6.38 [162.0]	1-1546306-6	1-1546307-6
17	7.05 [179.0]	6.73 [171.0]	1-1546306-7	1-1546307-7
18	7.40 [188.0]	7.13 [181.0]	1-1546306-8	1-1546307-8
19	7.79 [198.0]	7.48 [190.0]	1-1546306-9	1-1546307-9
20	8.15 [207.0]	7.87 [200.0]	2-1546306-0	2-1546307-0
21	8.54 [217.0]	8.23 [209.0]	2-1546306-1	2-1546307-1
22	8.90 [226.0]	8.62 [219.0]	2-1546306-2	2-1546307-2
23	9.29 [236.0]	8.98 [228.0]	2-1546306-3	2-1546307-3
24	9.65 [245.0]	9.37 [238.0]	2-1546306-4	2-1546307-4
25	10.04 [255.0]	9.72 [247.0]	2-1546306-5	2-1546307-5
26	10.39 [264.0]	10.12 [257.0]	2-1546306-6	2-1546307-6
27	10.79 [274.0]	10.47 [266.0]	2-1546306-7	2-1546307-7
28	11.14 [283.0]	10.87 [276.0]	2-1546306-8	2-1546307-8
29	11.54 [293.0]	11.22 [285.0]	2-1546306-9	2-1546307-9
30	11.89 [302.0]	11.61 [295.0]	3-1546306-0	3-1546307-0

Note: All part numbers are RoHS Compliant.

Double-Row, Dual-Barrier Strips (Continued)

.433 [11.0] Centerlines

Material & Finish

Insulator Body—UL94V-0, thermoplastic, black

Terminals—Brass, tin plated

Screw—#6-32 steel, nickel plated

Mechanical Properties

Screw Torque—12 in-lb

Electrical Properties

Current Rating—20 A, 300 VAC

Wire Range—14-22 AWG

Withstanding Voltage—2000 VAC min.

Environmental Properties

Operating Temperature—
-40°F to +221°F [-40°C to +120°C]

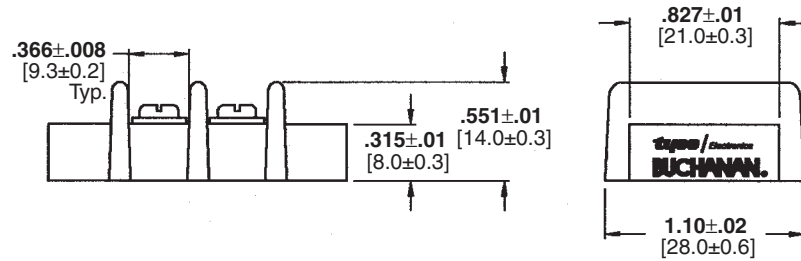
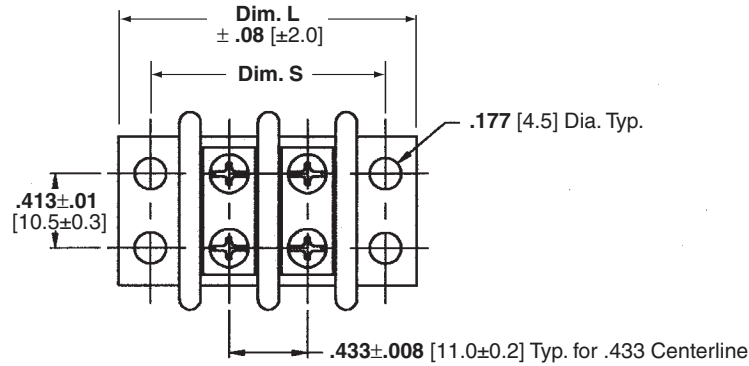

No. of Positions	Dimension		Part Numbers	
	L	S	w/Binding Head Screws	w/Wire Clamp Screws
2	1.65 [41.8]	1.264 [32.1]	1546481-2	1546477-2
3	2.08 [52.8]	1.697 [43.1]	1546481-3	1546477-3
4	2.51 [63.8]	2.130 [54.1]	1546481-4	1546477-4
5	2.94 [74.8]	2.563 [65.1]	1546481-5	1546477-5
6	3.38 [85.8]	2.996 [76.1]	1546481-6	1546477-6
7	3.81 [96.8]	3.429 [87.1]	1546481-7	1546477-7
8	4.24 [107.8]	3.862 [98.1]	1546481-8	1546477-8
9	4.68 [118.8]	4.295 [109.1]	1546481-9	1546477-9
10	5.11 [129.8]	4.728 [120.1]	1-1546481-0	1-1546477-0
11	5.54 [140.8]	5.161 [131.1]	1-1546481-1	1-1546477-1
12	5.98 [151.8]	5.594 [142.1]	1-1546481-2	1-1546477-2
13	6.41 [162.8]	6.028 [153.1]	1-1546481-3	1-1546477-3
14	6.84 [173.8]	6.461 [164.1]	1-1546481-4	1-1546477-4
15	7.27 [184.8]	6.894 [175.1]	1-1546481-5	1-1546477-5
16	7.71 [195.8]	7.327 [186.1]	1-1546481-6	1-1546477-6
17	8.14 [206.8]	7.760 [197.1]	1-1546481-7	1-1546477-7
18	8.57 [217.8]	8.193 [208.1]	1-1546481-8	1-1546477-8
19	9.01 [228.8]	8.626 [219.1]	1-1546481-9	1-1546477-9
20	9.44 [239.8]	9.059 [230.1]	2-1546481-0	2-1546477-0
21	9.87 [250.8]	9.492 [241.1]	2-1546481-1	2-1546477-1
22	10.31 [261.8]	9.925 [252.1]	2-1546481-2	2-1546477-2
23	10.74 [272.8]	10.358 [263.1]	2-1546481-3	2-1546477-3
24	11.17 [283.8]	10.791 [274.1]	2-1546481-4	2-1546477-4
25	11.61 [294.8]	11.224 [285.1]	2-1546481-5	2-1546477-5
26	12.04 [305.8]	11.657 [296.1]	2-1546481-6	2-1546477-6

Note: All part numbers are RoHS Compliant.

Double-Row, Dual-Barrier Strips (Continued)

.437 [11.1] Centerlines

Material & Finish

Insulator Body—UL94V-0, thermoplastic, black

Terminals—Brass, tin plated

Screw—#6-32 steel, nickel plated

Mechanical Properties

Screw Torque—12 in-lb

Electrical Properties

Current Rating—20 A, 300 VAC

Wire Range—14-22 AWG

Withstanding Voltage—2000 VAC min.

Environmental Properties

Operating Temperature—-40°F to +221°F [-40°C to +120°C]

Hardware Options

1776110-x—Single-sided Quick Connects, see page 176

1776057-x—Two-sided Quick Connects, see page 176

J7—Spade jumper, see page 177

J7140—Spade jumper, see page 177

J7240—Flanged jumper, see page 177

J7340—Ring tongue jumper, see page 177

J76—Over-the-barrier jumper, see page 177

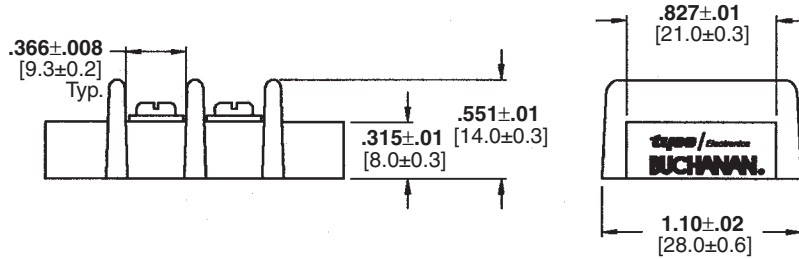
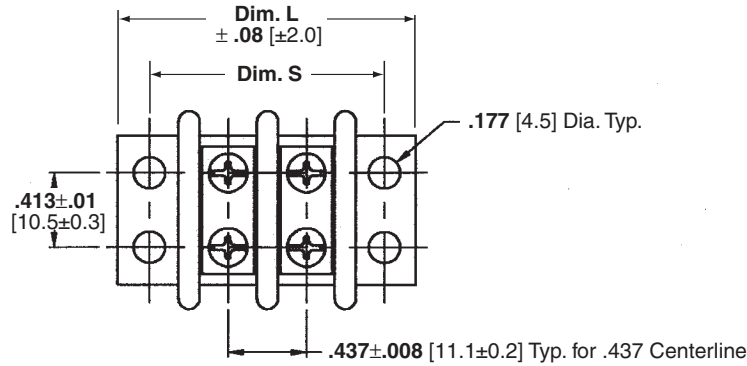

No. of Positions	Dimension		Part Numbers	
	L	S	w/Binding Head Screws	w/Wire Clamp Screws
2	1.62 [41.2]	1.264 [32.1]	1546670-2	1546671-2
3	2.06 [52.3]	1.697 [43.1]	1546670-3	1546671-3
4	2.50 [63.4]	2.130 [54.1]	1546670-4	1546671-4
5	2.93 [74.5]	2.563 [65.1]	1546670-5	1546671-5
6	3.37 [85.6]	2.996 [76.1]	1546670-6	1546671-6
7	3.81 [96.7]	3.429 [87.1]	1546670-7	1546671-7
8	4.24 [107.8]	3.862 [98.1]	1546670-8	1546671-8
9	4.68 [118.9]	4.295 [109.1]	1546670-9	1546671-9
10	5.12 [130.0]	4.728 [120.1]	1-1546670-0	1-1546671-0
11	5.55 [141.1]	5.161 [131.1]	1-1546670-1	1-1546671-1
12	5.99 [152.2]	5.594 [142.1]	1-1546670-2	1-1546671-2
13	6.43 [163.3]	6.028 [153.1]	1-1546670-3	1-1546671-3
14	6.87 [174.4]	6.461 [164.1]	1-1546670-4	1-1546671-4
15	7.30 [185.5]	6.894 [175.1]	1-1546670-5	1-1546671-5
16	7.74 [196.6]	7.327 [186.1]	1-1546670-6	1-1546671-6
17	8.18 [207.7]	7.760 [197.1]	1-1546670-7	1-1546671-7
18	8.61 [218.8]	8.193 [208.1]	1-1546670-8	1-1546671-8
19	9.05 [229.9]	8.626 [219.1]	1-1546670-9	1-1546671-9
20	9.49 [241.0]	9.059 [230.1]	2-1546670-0	2-1546671-0
21	9.93 [252.1]	9.492 [241.1]	2-1546670-1	2-1546671-1
22	10.36 [263.2]	9.925 [252.1]	2-1546670-2	2-1546671-2
23	10.80 [274.3]	10.358 [263.1]	2-1546670-3	2-1546671-3
24	11.24 [285.4]	10.791 [274.1]	2-1546670-4	2-1546671-4
25	11.67 [296.5]	11.224 [285.1]	2-1546670-5	2-1546671-5
26	12.11 [307.6]	11.657 [296.1]	2-1546670-6	2-1546671-6

Double-Row, Dual-Barrier Strips (Continued)

.563 [14.3] Centerline

Material & Finish

Insulator Body—UL94V-0, thermoplastic, black

Terminals—Brass, tin plated

Screw—M4.0 steel, nickel plated

Mechanical Properties

Screw Torque—16 in-lb

Electrical Properties

Current Rating—30 A, 300 VAC

Wire Range—10-22 AWG

Withstanding Voltage—2000 VAC min.

Environmental Properties

Operating Temperature—-40°F to +284°F [-40°C to +140°C]

Hardware Options

1776174-x—Single-sided Quick Connects, see page 176

1776173-x—Two-sided Quick Connects, see page 176

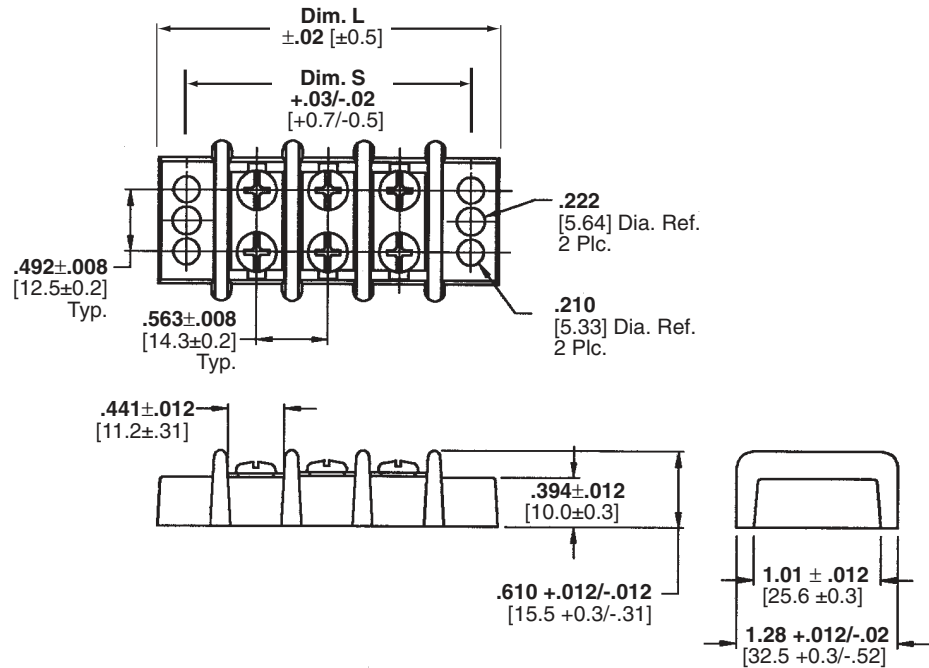

No. of Positions	Dimension		Part Numbers	
	L	S	w/Wire Clamp Screws	w/Binding Head Screws
2	2.13 [54.0]	1.69 [42.9]	1546311-2	1546310-2
3	2.69 [68.3]	2.25 [57.2]	1546311-3	1546310-3
4	3.25 [82.6]	2.81 [71.5]	1546311-4	1546310-4
5	3.81 [96.9]	3.38 [85.8]	1546311-5	1546310-5
6	4.38 [111.2]	3.94 [100.1]	1546311-6	1546310-6
7	4.94 [125.5]	4.50 [114.4]	1546311-7	1546310-7
8	5.50 [139.8]	5.07 [128.7]	1546311-8	1546310-8
9	6.08 [154.1]	5.63 [143.0]	1546311-9	1546310-9
10	6.63 [168.4]	6.19 [157.3]	1-1546311-0	1-1546310-0
11	7.19 [182.7]	6.76 [171.6]	1-1546311-1	1-1546310-1
12	7.75 [197.0]	7.32 [185.9]	1-1546311-2	1-1546310-2
13	8.32 [211.3]	7.88 [200.2]	1-1546311-3	1-1546310-3
14	8.88 [225.6]	8.44 [214.5]	1-1546311-4	1-1546310-4
15	9.44 [239.9]	9.01 [228.8]	1-1546311-5	1-1546310-5
16	10.02 [254.5]	9.57 [243.1]	1-1546311-6	1-1546310-6
17	10.57 [268.5]	10.13 [257.4]	1-1546311-7	1-1546311-7
18	11.13 [282.8]	10.70 [271.7]	1-1546311-8	1-1546310-8

Note: All part numbers are RoHS Compliant.

Double-Row, Dual-Barrier Strips w/o Washer

.563 [14.3] Centerline

Material & Finish

Insulator Body—UL94V-0, thermoplastic, black

Terminals—Brass, tin plated

Screw—M4.0 steel, nickel plated

Mechanical Properties

Screw Torque—14 in-lb

Electrical Properties

Current Rating—30 A, 600 VAC

Wire Range—10-22 AWG

Withstanding Voltage—2000 VAC min.

Environmental Properties

Operating Temperature—-40°F to +120°F [-40°C to +49°C]

Hardware Options

1776174-x—Single-sided Quick Connects, see page 176

1776173-x—Two-sided Quick Connects, see page 176

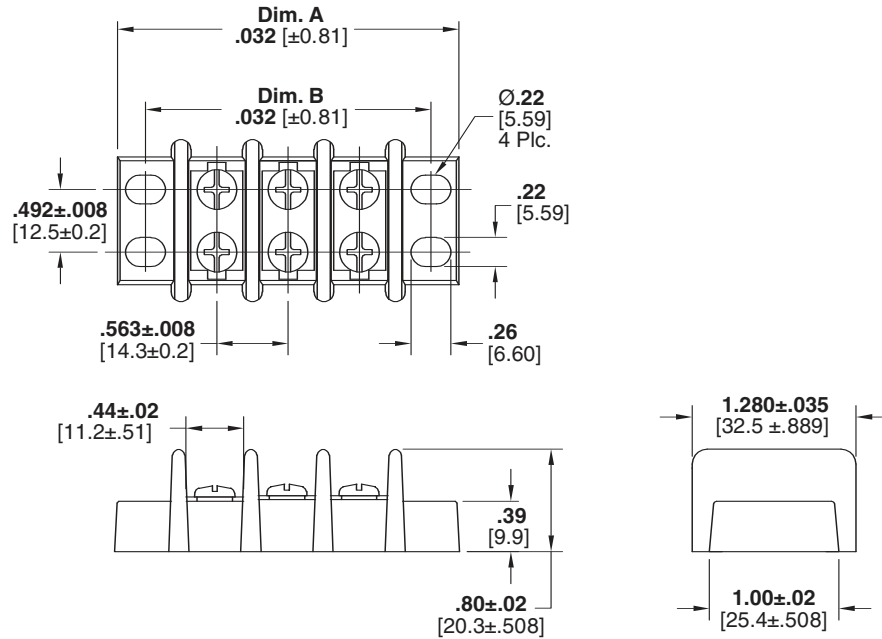

No. of Positions	Dimension		Part Numbers	
	L	S	w/Wire Clamp Screws	w/Binding Head Screws
2	2.13 [54.0]	1.69 [42.9]	1776544-2	1986158-2
3	2.69 [68.3]	2.25 [57.2]	1776544-3	1986158-3
4	3.25 [82.6]	2.81 [71.5]	1776544-4	1986158-4
5	3.81 [96.9]	3.38 [85.8]	1776544-5	1986158-5
6	4.38 [111.2]	3.94 [100.1]	1776544-6	1986158-6
7	4.94 [125.5]	4.50 [114.4]	1776544-7	1986158-7
8	5.50 [139.8]	5.07 [128.7]	1776544-8	1986158-8
9	6.08 [154.1]	5.63 [143.0]	1776544-9	1986158-9
10	6.63 [168.4]	6.19 [157.3]	1-176544-0	1-1986158-0
11	7.19 [182.7]	6.76 [171.6]	1-176544-1	1-1986158-1
12	7.75 [197.0]	7.32 [185.9]	1-176544-2	1-1986158-2
13	8.32 [211.3]	7.88 [200.2]	1-176544-3	1-1986158-3
14	8.88 [225.6]	8.44 [214.5]	1-176544-4	1-1986158-4
15	9.44 [239.9]	9.01 [228.8]	1-176544-5	1-1986158-5
16	10.02 [254.5]	9.57 [243.1]	1-176544-6	1-1986158-6
17	10.57 [268.5]	10.13 [257.4]	1-176544-7	1-1986158-7
18	11.13 [282.8]	10.70 [271.7]	1-176544-8	1-1986158-8

Barrier Strip Sockets

Mateability for the socket line is given below:

Socket Series	Connector Series
USB	RSB3, SSB3
RSB6B	RSB6

Product Facts

- n End-to-end mounting of USB sockets maintain circuit spacing: Two 12-circuit USB sockets can mate with one 24-circuit SSB3 or RSB3.
- n Secure mating with built-in locking arms

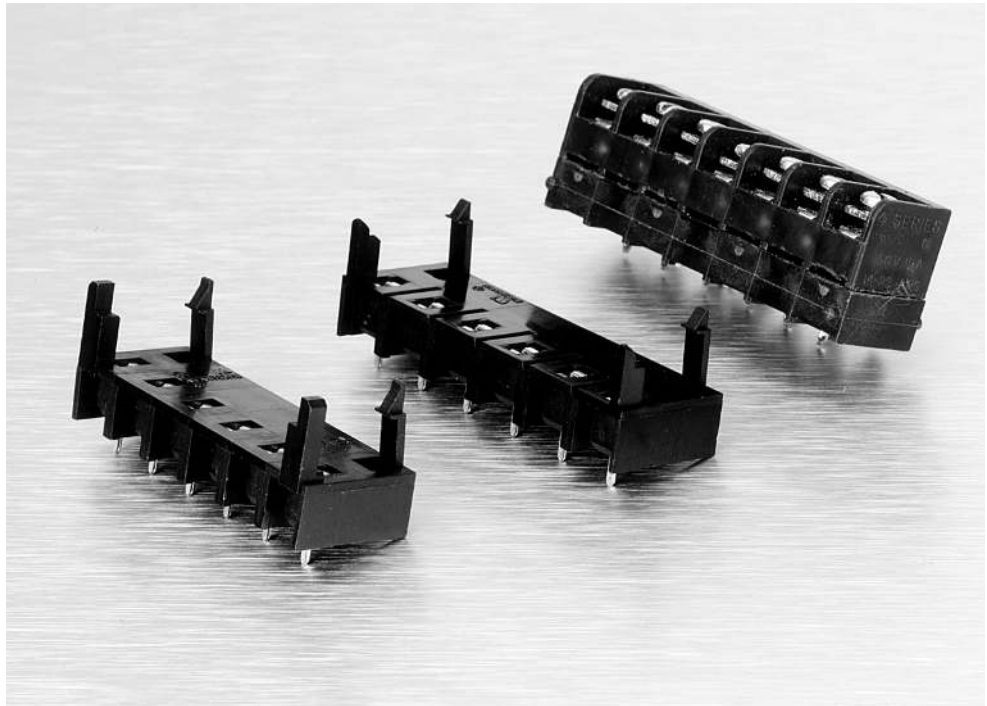

This unique plug-in socket line allows quick connection of circuits simultaneously without the use of tools.

They are designed to be wave-soldered to a PC board, after which the connector is plugged into the socket.

Note: All part numbers are RoHS Compliant.

0.325" [8.26] Pitch, Series USB Socket (for Series RSB3 and SSB3)

USB3B08S & SSB3FP080202

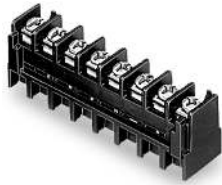

Material & Finish

Housing Material—Polyamide, Type 6/6

Flammability—UL94V-2

Color—Black

Terminals Contact—Copper alloy, bright tin plating

Pin—Copper alloy, bright tin plating

Mechanical Properties

Pitch (Terminal Spacing)—0.325" [8.26]

Recommended PCB Hole Dia.—.055" [1.40]

Pullout Force—5-7 lbs.

Electrical Properties

Ratings—UL Class B 10 Amps, 300V
CSA Type B 15 Amps, 300V
CSA Type D 10 Amps, 300V

Dielectric Withstand—3500V

Environmental Properties

Operating Temperature Range—-60°C to +105°C [-76°F to +221°F]

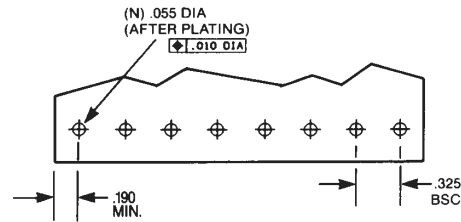
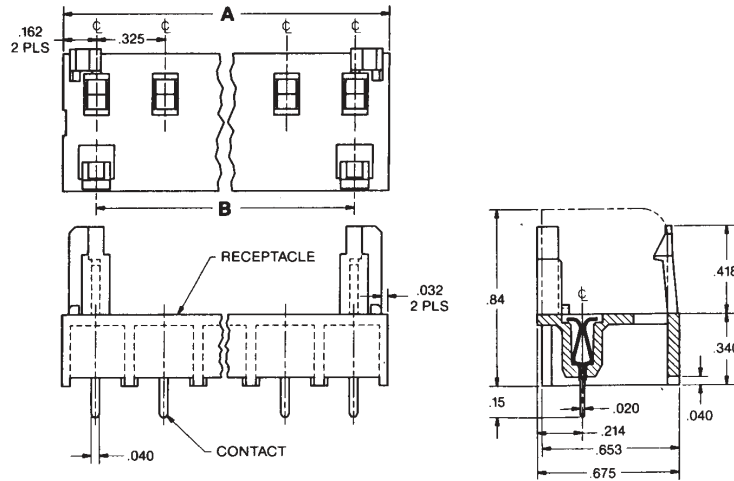

Recommended PCB Hole Pattern

No. of Circuits	Dimensions		Dual-Barrier Mating Strip Catalog Number	Tri-Barrier Mating Strip Catalog Number	Catalog Number
	A	B			
2	0.650	0.325	SSB3FP0202...	RSB3VP0212...	USB3B02S
3	0.975	0.650	SSB3FP0302...	RSB3VP0312...	USB3B03S
4	1.300	0.975	SSB3FP0402...	RSB3VP0412...	USB3B04S
5	1.625	1.300	SSB3FP0502...	RSB3VP0512...	USB3B05S
6	1.950	1.625	SSB3FP0602...	RSB3VP0612...	USB3B06S
7	2.275	1.950	SSB3FP0702...	RSB3VP0712...	USB3B07S
8	2.600	2.275	SSB3FP0802...	RSB3VP0812...	USB3B08S
9	2.925	2.600	SSB3FP0902...	RSB3VP0912...	USB3B09S
10	3.250	2.925	SSB3FP1002...	RSB3VP1012...	USB3B10S
11	3.575	3.250	SSB3FP1102...	RSB3VP1112...	USB3B11S
12	3.900	3.575	SSB3FP1202...	RSB3VP1212...	USB3B12S
13	4.225	3.900	SSB3FP1302...	RSB3VP1312...	USB3B13S
14	4.550	4.225	SSB3FP1402...	RSB3VP1412...	USB3B14S

Note: See page 165 to complete mating Tri-Barrier Strip Catalog Number.
See page 169 to complete mating Dual-Barrier Strip Catalog Number.



0.375" [9.53] Pitch, Series RSB6B Socket (for Series RSB6 Tri-Barrier)

RSB6B06S



Material & Finish

Housing Material—Polyamide

Flammability—UL94V-2

Color—Black

Terminals—Copper alloy, bright tin plating

Pin—Copper alloy, bright tin plating

Mechanical Properties

Pitch (Terminal Spacing)—

.375 in [9.53]

Recommended PCB Hole Dia.—
.062" [1.57]

Electrical Properties

Ratings—UL Class B 20 Amps, 300V

CSA Type B 10 Amps, 300V

CSA Type D 5 Amps, 600V

Dielectric Withstand—3500V

Environmental Properties

Operating Temperature Range—

-60°C to +105°C [-76°F to +221°F]

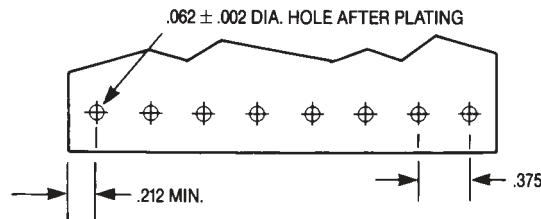
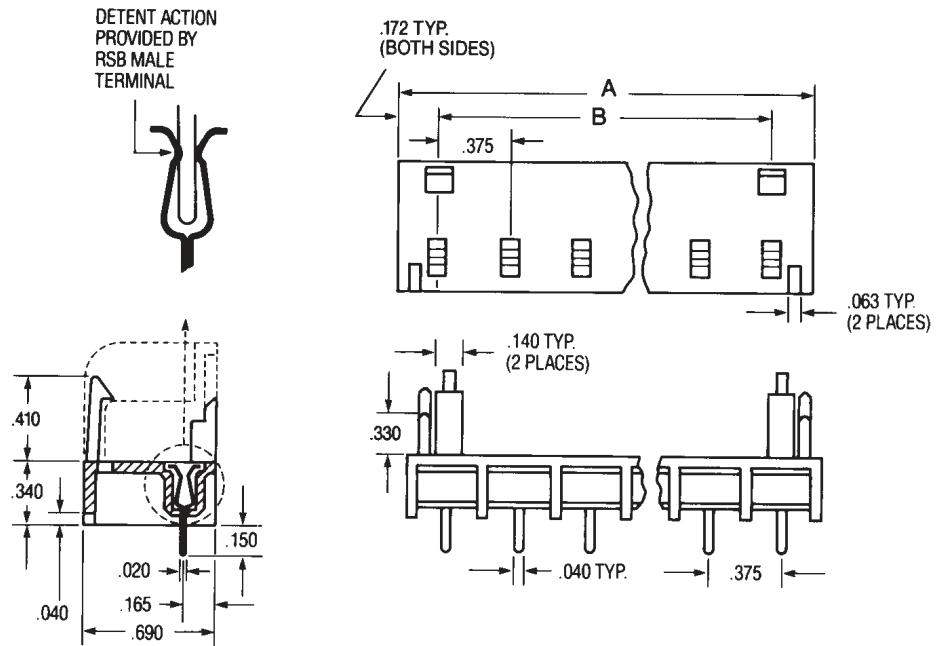

Recommended PCB Hole Pattern

No. of Circuits	Dimensions		Catalog Number
	A	B	
02	0.720	0.375	RSB6B02S
03	1.094	0.750	RSB6B03S
04	1.469	1.125	RSB6B04S
05	1.844	1.500	RSB6B05S
06	2.219	1.875	RSB6B06S
07	2.594	2.250	RSB6B07S
08	2.869	2.625	RSB6B08S
09	3.244	3.000	RSB6B09S
10	3.720	3.375	RSB6B10S

Note: RSB6 Tri-Barrier Blocks should be ordered with Number 12 Terminal Style (printed circuit pin, V mounting) when used in combination with this plug-in socket. See page 172 for ordering information.

Note: All part numbers are RoHS Compliant.

0.325" [8.26] Pitch, Series RSB3

RSB3VP061202



Material & Finish

- Housing Material**—Polypropylene
- Flammability**—UL94V-2
- Color**—Black
- Terminals**—Brass w/bright Tin plating
- Screws**—Steel w/Zinc + Chromate plating

Mechanical Properties

- Pitch (Terminal Spacing)**—
.325 in [8.26]
- Screw Size**—6-32
- Recommended PCB Hole Dia.**—
0.062"

Wire Strip Length—
.31 in [7.87]

Recommended Tightening Torque—
9 in-lbs.

Recommended Screwdrivers—
Stanley 1006-4, Sears Craftsman 41581, Any #2 Phillips-Head

Wire Lug Width (Max.)—
.265 in [6.73]

Electrical Properties

- Maximum Current**—15A
- Operating Voltage**—300V
- Wire Range**—#14-26 AWG
- Dielectric Withstand**—4000V

Environmental Properties

Operating Temperature Range—
-60°C to +105°C [-76°F to +221°F]
For mating socket, see pg. 162.

Computing Barrier Block Lengths

Direct Mounting—Use C1 and L1 for Mounting Option "P".

End Position Mounting—Use C2 and L2 for Mounting Option "M".

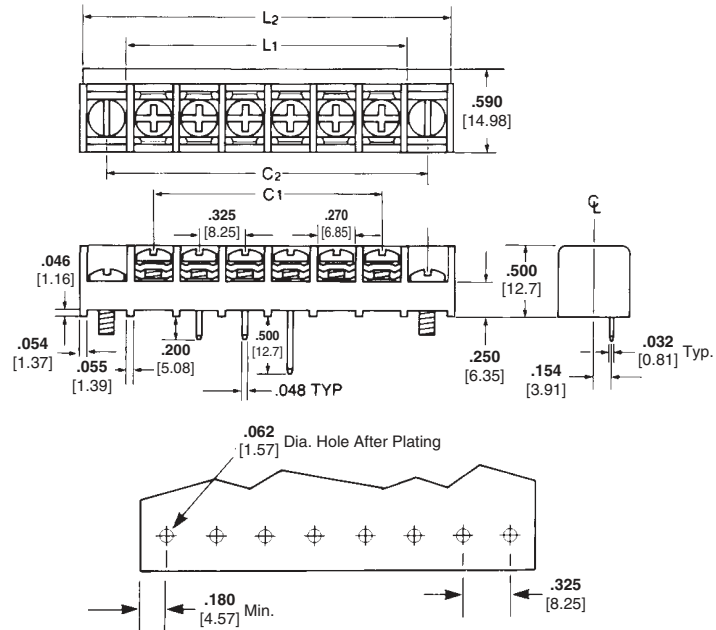

Dimensions

Circuits (not positions)	C1 in.	L1* in.	C2 in.	L2* in.
02	0.325	0.704	0.975	1.354
03	0.650	1.029	1.300	1.679
04	0.975	1.354	1.625	2.004
05	1.300	1.679	1.950	2.329
06	1.625	2.004	2.275	2.654
07	1.950	2.329	2.600	2.979
08	2.275	2.654	2.925	3.304
09	2.600	2.797	3.250	3.629
10	2.925	3.304	3.575	3.954
11	3.250	3.629	3.900	4.279
12	3.575	3.954	4.225	4.604
13	3.900	4.279	4.550	4.929
14	4.225	4.604	4.875	5.254
16	4.875	5.254	5.525	5.904
17	5.200	5.579	5.850	6.229
18	5.525	5.904	6.175	7.554
19	5.850	6.229	6.500	6.879
20	6.175	6.554	6.825	7.204
21	6.500	6.879	7.150	7.529
22	6.825	7.204	7.475	7.854
23	7.150	7.529	7.800	8.179
24	7.475	7.854	8.125	8.504
25	7.800	8.179	8.450	8.829
26	8.125	8.504	8.775	9.154
27	8.450	8.829	9.100	9.479
28	8.775	9.154	9.425	9.804
29	9.100	9.479	9.750	10.129
30	9.425	9.804	10.075	10.454
31	9.750	10.129	10.400	10.779
32	10.075	10.454	10.725	11.104
33	10.400	10.779	11.050	11.429
34	10.725	11.104	11.357	11.754
35	11.050	11.429	—	—
36	11.357	11.754	—	—

*L2 and L1 are based on molded-to-length strips.



Note: All part numbers are RoHS Compliant.

0.325" [8.26] Pitch, Series RSB3 (Continued)

Ordering Information

RSB 3 V P 06 12 02 11
A B C D E F G H

A Single Screw Tri-Barrier Strip RSB



B Contact Spacing (Center-to-Center)
 3=.325 in.

C Mounting Position
 V=Vertical Mounting



D End Contact Mounting Options
M=End Position Mounting: open end positions with barriers.
P=Direct Mounting: all positions filled with contacts, with barriers

E No. of Circuits (Not Positions)
02 through **34** for M Option
02 through **36** for P Option

F Terminal Style
12=Printed Circuit Pin for use with USB3 Series Socket
15=Superseded by 4 PCR per page 125
17=Superseded by 4WWV, page 125

G Top Hardware Options
01=Bright zinc and chromate plated steel binding-head screw

02=Bright zinc and chromate plated steel screw and captive clamp – Do not order in combination with other top hardware.

Quick-Connect Blades
 (supplied with 01 screw)

.110 wide		.187 wide	
x.020 thick		x.020 thick	
13	73=		
14	74=		
15	75=		

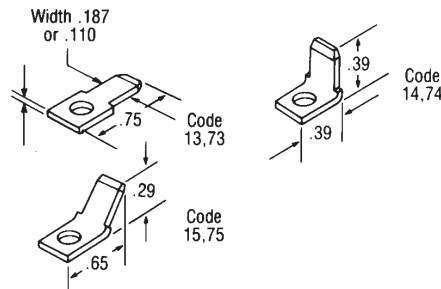
Catalog Number Codes: 13 through 15 and 73 through 75. A complete selection of .187" and .110" quick-connect blades for connecting wire terminated with female quick connects. Single-sided types in flat, 45° and 90° angle bends can be supplied. Material is brass with tin plating. All blades supplied with 01 screws. Various quick-connects can be combined.



H Circuit Identification Options
 Catalog Number Codes: 11 through 18 and 21 through 28. RSB3 blocks may be ordered with white circuit identification numbers on the molding in 16 variations. Custom markings available on special order.

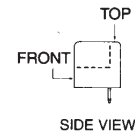
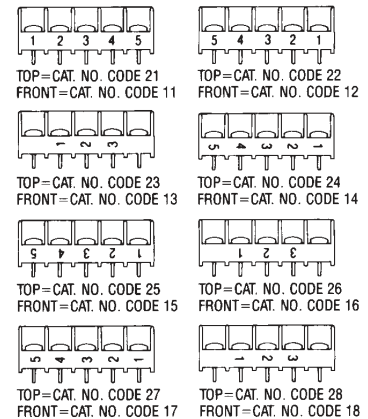

For mating socket, see pg. 162.



Barrier Strips
2

Note: All part numbers are RoHS Compliant.

0.325" [8.26] Pitch, Series RSB3 (Continued)

Mounting Position

Vertical Mounting

Catalog Letter Code: V. Used where direct top-to-bottom feed-through is required with no need for circuit isolation on the bottom side. The most common example of this is printed circuit board mounting.

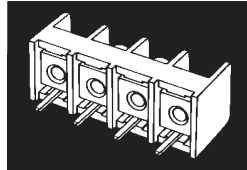

End Contact Mounting Options

End Position Mounting

Catalog Letter Code: M. Supplied without contact in end sections to allow installer to mount blocks with screws in end section holes. Base of block will support #6 mounting screws.

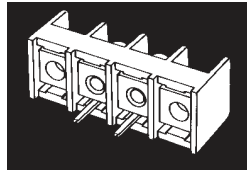

Direct Mounting

Catalog Letter Code: P. RSB3 may be solder-mounted using the bottom terminals themselves, as in the case of printed circuit board applications.

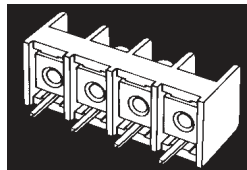

Terminal Style

Printed Circuit Pin

Catalog Number Code: 12. Designed specifically for use with our USB3 socket, page 162

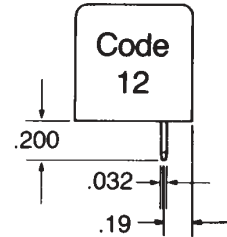

Hardware Options

- 3C1xxx**—Safety cover, see page 175
- J3140**—Jumpers, see page 177
- 3L02**—Wire clamp screw, see page 178
- 3L01**—Binding head screw, see page 178

Note: All part numbers
are RoHS Compliant.

Engineering Notes



Note: All part numbers are RoHS Compliant.

0.325" [8.26] Pitch, Series SSB3

SSB3FP##0202

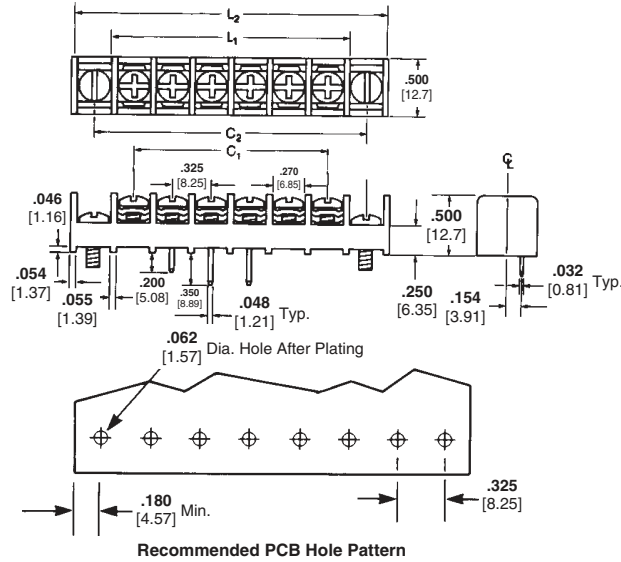
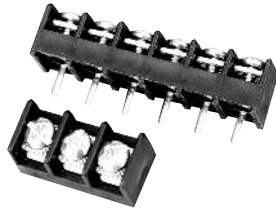

Material & Finish

- Housing Material**—Polypropylene
- Flammability**—UL94V-2
- Color**—Black
- Terminals**—Brass, bright acid tin over copper plating
- Screw**—Steel w/ Zinc + Chromate plating

Mechanical Properties

- Pitch (Terminal Spacing)**—.325" [8.26]
- Screw Size**—6-32
- Recommended PCB Hole Dia.**—.062" [1.57]
- Wire Strip Length**—.31" [7.87]
- Recommended Tightening Torque**—9 in.-lbs.
- Recommended Screwdrivers**—Stanley 1006-4, Sears Craftsman 41581, Any #2 Phillips Head.
- Wire Lug Width (Max.)**—.265" [6.73]

Electrical Properties

- Ratings**—UL Class B 20 Amps, 300V
UL Class C 20 Amps, 300V
UL Class D 10 Amps, 300V
CSA Type B 10 Amps, 300V
CSA Type D 10 Amps, 300V

- Wire Range**—#14-26 AWG
- Dielectric Withstand**—4500V

Environmental Properties

- Operating Temperature Range**—60°C to +105°C [-76°F to +221°F]

Computing Barrier Block Lengths

Direct Mounting—Use C1 & L1 for Mounting Option "P".

End Position Mounting—Use C2 & L2 for Mounting Options "F" and "M".

For mating socket, see pg. 162.

Dimensions

Circuits (not positions)	C1 in.	L1* in.	C2 in.	L2* in.
02	0.325	0.704	0.975	1.354
03	0.650	1.029	1.300	1.679
04	0.975	1.354	1.625	2.004
05	1.300	1.679	1.950	2.329
06	1.625	2.004	2.275	2.654
07	1.950	2.329	2.600	2.979
08	2.275	2.654	2.925	3.304
09	2.600	2.979	3.250	3.629
10	2.925	3.304	3.575	3.954
11	3.250	3.629	3.900	4.279
12	3.575	3.954	4.225	4.604
13	3.900	4.279	4.550	4.929
14	4.225	4.604	4.875	5.254
15	4.550	4.949	5.200	5.579
16	4.875	5.254	5.525	5.579
17	5.200	5.579	5.850	6.229
18	5.525	5.904	6.175	7.554
19	5.850	6.229	6.500	6.879
20	6.2175	6.554	6.825	7.204
21	6.500	6.879	7.150	7.529
22	6.825	7.204	7.475	7.854
23	7.150	7.529	7.800	8.179
24	7.475	7.854	8.125	8.504
25	7.800	8.179	8.450	8.829
26	8.125	8.504	8.775	9.154
27	8.450	8.829	9.100	9.479
28	8.775	9.154	9.425	9.804
29	9.100	9.479	9.750	10.129
30	9.425	9.804	10.075	10.454
31	9.750	10.129	10.400	10.779
32	10.075	10.454	10.725	11.104
33	10.400	10.779	11.050	11.429
34	10.725	11.104	11.375	11.754
35	11.050	11.429	—	—
36	11.375	11.754	—	—



EC/98/003-01 12241/CL LR25557 E63810

Note: All part numbers are RoHS Compliant.

0.325" [8.26] Pitch, Series SSB3 (Continued)

Ordering Information

SSB 3 F P 06 02 02 Suffix
A B C D E F G H

A Single Screw Dual-Barrier Strip SSB

B Contact Spacing
(Center-to-Center)
3=.325 in.

C Base
F=Raised Base

D Mounting Options
F= Open end positions without end barriers
M= Open end positions with end barriers
P= All positions filled with contacts, with end barriers

E No. of Circuits (Not Positions)
02 through 36

F Terminal Style
02= Printed Circuit Pin
04= Extended Circuit Board
11= Right-Angle Bend .18 x .12

G Top Hardware Options
01= Bright zinc and chromate plated steel binding-head screw



02= Bright zinc and chromate plated steel screw and captive clamp – Do not order in combination with other top hardware.



Quick-Connect Blades
(supplied with 01 screw)

		.110 wide	.187 wide
		x.020	x.020
		thick	thick
10	70=		
11	71=		
12	72=		
13	73=		
14	74=		
15	75=		

H Circuit Identification Options
Catalog Number Codes: 11 through 16. SSB blocks may be ordered with circuit identification numbers in white on the molding in six different variations. Custom markings are available on special order.

11=	12345...
12=	...54321
13=	
14=	
15=	12345...12345...
16=	...54321...54321...

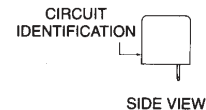
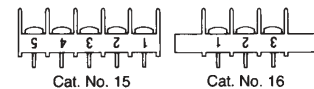
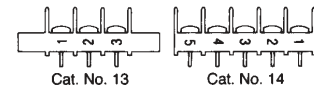
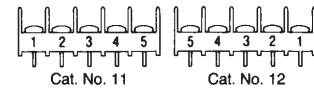

Hardware Options

- 3C1xxx**—Safety cover, see page 175
- J3140**—Jumpers, see page 177
- 3L02**—Wire clamp screw, see page 178
- 3L01**—Binding head screw, see page 178
- QC1x**—.110 Quick connects, see page 176
- QC7x**—.187 Quick connects, see page 176

For mating socket, see pg. 162.



Barrier Strips

2

Note: All part numbers are RoHS Compliant.

0.325" [8.26] Pitch, Series SSB3, Options

Base

Catalog Letter Code: F. Lends itself most readily to applications where direct top-to-bottom feed-through is required with no special requirement for circuit isolation on the bottom side. The most common example of this is printed circuit board mounting.

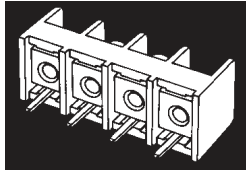

Mounting Options

End Position Mounting

Catalog Letter Code: M. Provides a printed circuit board mounting option with top-side wire entry.

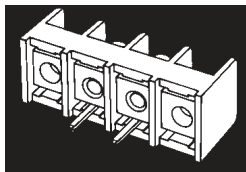

End Position Mounting Without Barriers

Catalog Letter Code: F. Facilitates mounting-screw access when end sections are used for mounting.

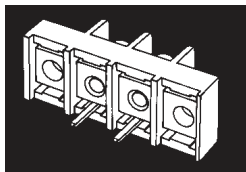

Direct Mounting:

Catalog Letter Code: P. SSBs may be solder-mounted using the bottom terminals themselves, as in the case of printed circuit board applications.

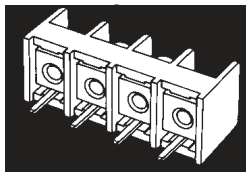

Printed Circuit Pin:

Catalog Number Code: 02.

Designed specifically for mounting on .063" thick circuit board. Special, readily solderable plating permits good fillet development in automated soldering processes.

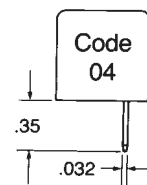
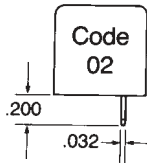

Extended Printed Circuit Pin:

Catalog Number Code: 04. Useful where extra length is needed, as in thicker printed circuit boards or single-wrap connections.

Quick Connects

Catalog Number Codes: 10 through 75.

A complete selection of .187" and .110" quick-connect blades are available for connecting wire terminated with female quick connects. Single- and double-sided types in flat, 45° and 90° angle bends can be supplied. Material is brass with tin plating. All blades supplied with O1 screws. Various quick-connects can be combined.

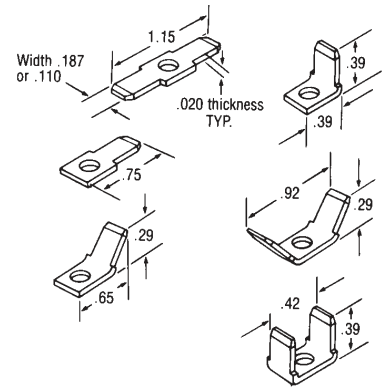

Top Hardware Options

Binding Head Screws

Catalog Number Code: 01. In most applications, binding head screws will provide excellent wire retention because of exclusive wire locking tabs. Screws are bright zinc and chromate plated steel.



Captive Clamp

Catalog Number Code: 02.

For applications requiring extra security, captive clamps under the screw heads augment the locking tabs on each contact. Screws have a unique Phil-slot design accepting either Phillips-head or straight screwdriver. Code 02 screw is bright zinc and chromate plated steel.



Note: All part numbers are RoHS Compliant.

0.375" [9.53] Pitch, Series RSB6

RSB6RP##1102

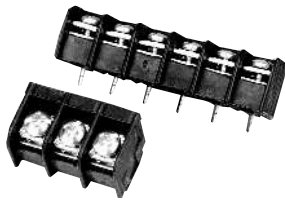

Material & Finish

- Housing Material**—Polypropylene
- Flammability**—UL94V-2
- Color**—Black
- Terminals**—Brass, bright acid tin over copper plating
- Screw**—Steel w/Zinc + Chromate plating

Mechanical Properties

Pitch (Terminal Spacing)—
.375" [9.53]

Screw Size—6-32

Recommended PCB Hole Dia.—
.062" [1.57]

Wire Strip Length—
.38" [9.65]

Recommended Tightening

Torque—12 in.-lbs.

Recommended Screwdrivers—
Stanley 1006-4, Sears Craftsman 41581,
Any #2 Phillips-Head

Wire Lug Width (Max.)—8.1mm
[.320"]

Electrical Properties

Ratings—UL Class B 20 Amps, 300V
CSA Type C 15 Amps, 150V
CSA Type D 10 Amps, 300V

Wire Range—12-22 AWG

Dielectric Withstand—3500V

Environmental Properties

Operating Temperature Range—
60°C to +105°C [-76°F to +221°F]

Computing RSB Block Lengths

Direct Mounting – Use C1 & L1 for
VP, SP, RP mounting options

End Position Mounting – Use L2 &
C2 for VM, SM, RM, VE, SE, RE
mounting options

For mating socket, see pg. 163.

Hardware Options

J6—Jumpers, see page 177

L02—Wire clamp screw, steel,
see page 178

L09—Wire clamp screw, brass,
see page 178

L01—Binding head screw,
see page 178

L04—Binding head screw, brass,
see page 178

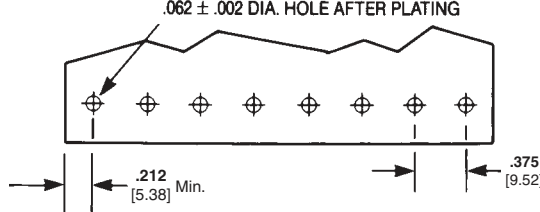
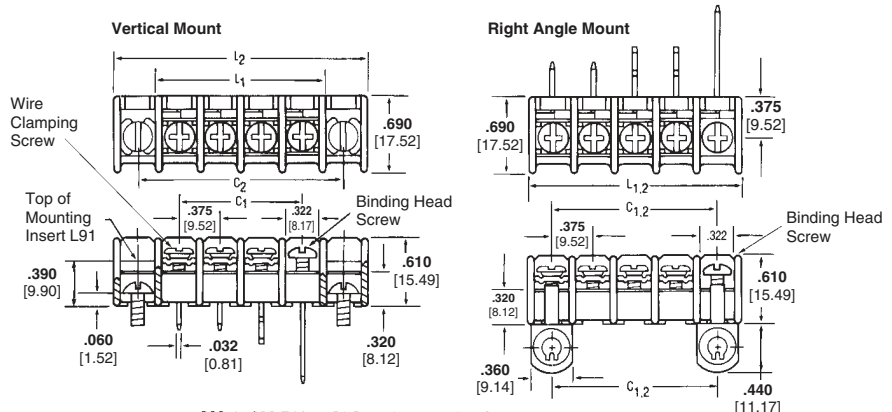

Dimensions

Circuits (not positions)	C1 in.	L1* in.	C2 in.	L2* in.
01	—	—	0.75	1.22
02	0.37	0.84	1.13	1.59
03	0.75	1.22	1.50	1.97
04	1.13	1.59	1.88	2.34
05	1.50	1.97	2.25	2.72
06	1.88	2.34	2.63	3.09
07	2.25	2.72	3.00	3.47
08	2.63	3.09	3.37	3.84
09	3.00	3.47	3.75	3.84
10	3.37	3.84	4.13	4.59
11	3.75	4.22	4.50	4.97
12	4.13	4.59	4.88	5.34
13	4.50	4.97	5.25	5.72
14	4.88	5.34	5.63	6.09
15	5.25	5.72	6.00	6.47
16	5.63	6.09	6.38	6.84
17	6.00	6.47	6.75	7.22
18	6.38	6.84	7.13	7.59
19	6.75	7.22	7.50	7.97
20	7.13	7.59	7.88	8.34
21	7.50	7.97	8.25	8.72
22	7.88	8.34	8.63	9.09
23	8.25	8.72	9.00	9.47
24	8.63	9.09	9.75	9.84
25	9.00	9.47	9.75	10.22
26	9.38	9.84	10.13	10.59
27	9.75	10.22	10.50	10.97
28	10.13	10.59	10.88	11.34
29	10.50	10.97	11.25	11.72
30	10.88	11.34	11.63	12.09
31	11.25	11.72	12.00	12.47
32	11.63	12.09	12.38	12.84
33	12.00	12.47	12.75	13.22
34	12.38	12.84	13.13	13.59
35	12.75	13.22	13.50	13.97
36	13.13	13.59	13.88	14.34

Barrier Strips

2

Note: All part numbers are RoHS Compliant.

0.375" [9.56] Pitch, Series RSB6 (Continued)

Ordering Information

RSB 6 R P 07 12 02 11
A **B** **C** **D** **E** **F** **G** **H**

A Single Screw Tri-Barrier Strips RSB

B Contact Spacing
6=.375 in. (6/16)

C Mounting Position Options
V= Vertical Mounting
H= High Rise (use with #18 terminal style)

D End Contact Options
E= Open end pos. with mounting inserts
M= Open end positions
P= All positions filled with contacts

E No. of Circuits (Not Positions)
02 through 34 for M Option
02 through 36 for P Option

F Terminal Style
11=Superseded by 6STV, page 129
12=Circuit Board, V Mounting (select this option when block is to be used with RSB plug-in socket)
13=Superseded by 6TBV, page 129
14=Superseded by 6STR, page 129
15=Superseded by 6PCR, page 129
16=Superseded by 6WWR, page 129
17=Superseded by 6WWV, page 129
18=Circuit Board (for High Rise Mounting)

G Top Hardware Options
01= Bright zinc and chromate plated steel binding-head screw
02= Bright zinc and chromate steel screw and captive clamp – Do not order in combination with other top hardware
03=Stainless steel binding-head screw
04=Nickel plated brass binding-head screw
09=Nickel plated brass screw and captive clamp – Do not order in combination with other top hardware

Quick-Connect Blades
(supplied with 01 screw)

		.250 [6.35] wide	.187 [4.75] wide
		x.032 [.81]	x.020 [.51]
		thick	thick
22	42=	┌	
23	43=	└	
24	44=	└┐	
25	45=	└┐	
29	49=	└┐	
30	50=	└┐	
31	51=	└┐	
33	53=	└┐	
35	55=	└┐	
36	56=	└┐	

H Circuit Identification Options
Request drawing C7013624 for complete information

Front	Top
11	21 = 12345...
12	22 = ...54321
13	23 = └┐┐┐┐┐┐ . . .
14	24 = . . . └┐┐┐┐┐┐
15	25 = 12345...└┐┐┐┐┐
16	26 = ...54321└┐┐┐┐┐
17	27 = └┐┐┐┐┐┐ . . .
18	28 = . . . └┐┐┐┐┐┐

For mating socket, see pg. 152.



Note: All part numbers are RoHS Compliant.

0.375" [9.56] Pitch, Series RSB6, Features/Options

Terminal Style

Vertical Terminal

Catalog Number Code 12: Designed specifically for use with our RSB6B Socket, page 163.

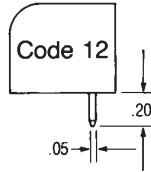

Mounting & Contact Position Options

Vertical, Direct Mounting

Catalog Code VP: This configuration is frequently used on printed circuit boards where solder connections are used to fasten the block to the board.

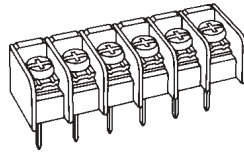

Vertical, End Position Mounting

Catalog Code VM:

Used where end sections are needed for mounting. Thickness of base is sufficient to support mounting screws.

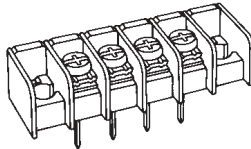

High Rise, All Positions Filled with Contacts

Catalog Code HP:

Designed for high density; two rows deep when used in conjunction with a VP configuration.

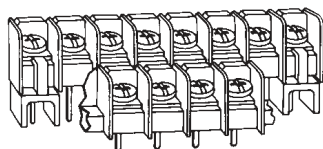

Top Hardware Options:

Binding Head Screws

Four Styles Available.



Captive Clamp

Catalog Number Code: 02 & 09.

For applications requiring extra security, captive clamps under the screw heads augment the locking tabs on each contact. Screws have #8 pan head with a unique Phil-slot design accepting either Phillips-head or straight screwdriver. The body is #6 to allow use of larger wire.



Quick Connects

Catalog Code below: A selection of .187" and .250" quick connect blades with tin plated brass are available for connecting wire terminated with female quick-connects. They are available individually or in combination. See ordering information.

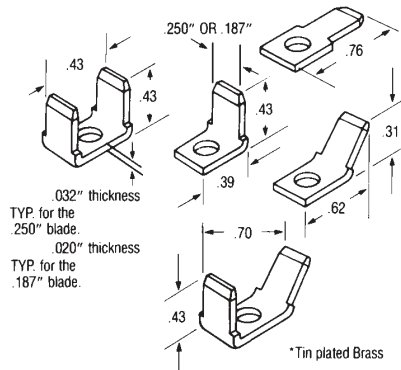

High Rise, Mounting Standoffs

Designed for high density; allows two rows of contacts on two levels when used with a VP mounting configuration.



Note: All part numbers are RoHS Compliant.

Accessories — Barrier Strip Safety Covers

For Series BC6, #3, JC6



For Series BC6, #3, JC6 Mounting

TC 3—Aluminum mounting bushings and screws

TC 2, 9—Plastic fasteners attached to block with thru-bolts and nuts (not supplied)

Center Spacing

TC 3—0.250 inch [6.35]

TC 2, 9—0.375 inch [9.56]

Material—Clear, rigid PVC, UL94V-0

For Series #4, #6, #8 Physical Properties

Centerline spacing—8.2/[.325] - 9.5/[.375] 11.1/[.4375]

Positions—2 thru 16, molded to length

Material—Black, thermoplastic, UL94V-0

Shock and Vibration—to MIL.STD. 1344 method 2005.1 Condition III.

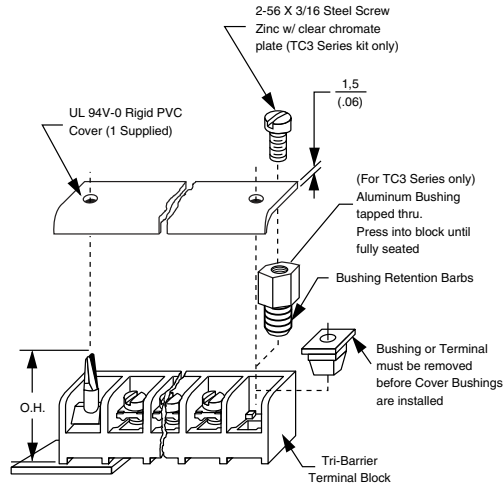

For Series #4, #6, #8

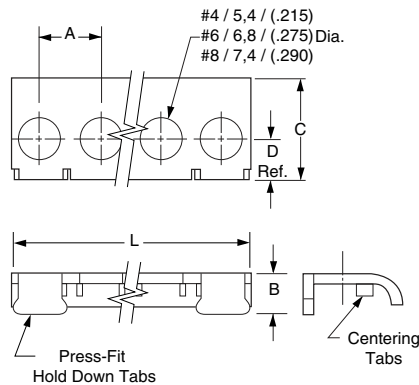

Ordering Information

TC 4 - 06 - PFH - CL

A B C D E

- A Series**
TC = Cover
- B Center Spacing**
2 = BC6 Series
3 = #3 Series
4 = #4 Series
6 = #6 Series
8 = #8 Series
9 = JC6 Series
- C No. of Circuits**
(Not positions)
02 through 24 for Series BC6, JC6
02 through 30 for Series #3
02 through 16 for Series #4, #6, #8

- D Access Holes**
PF* = Press Fit without holes
PFH* = Press Fit with holes
AG = Adder for Series BC6, #3, JC6
- E Color** (add for Series #4, #6, #8 only)
(blank) = Black (Series BC6, #3, JC6 are clear)
CL = Translucent (Available only for Series #4, #6, #8)

Overall Height (O.H.)		
TC2	TC3	TC9
0.970"	0.650"	0.970"

* Add for Series #4, #6, #8

Catalog #	A	B	C	D Ref.	L
TC4	8,2 (.325)	6,0 (.238)	13,5 (.531)	5,7 (.225)	A* (N-1)+7,9/(.312) #4
TC6	9,5 (.375)	6,3 (.250)	13,3 (.525)	6,4 (.253)	A* (N-1)+4/(.370) #6
TC8	11,1 (.4375)	8,1 (.314)	21,5 (.846)	11,1 (.4375)	A* (N-1)+10,9/(.430) #8

Note: All part numbers are RoHS Compliant.

Accessories — Barrier Strip Safety Covers (Continued)

Safety Covers

Dead front protection designed to prevent accidental contact with energized circuits. Access holes for test probes are provided over each terminal. Nylon clips are included with each cover. Covers meet UL94V-0, with 50°C temperature index. Blank circuit identification optional.

For SSB3, RSB3, RSB6 and SSB7 Series.

Related Product Data

Wire Pins and Ferrules

Pages 109-111
For more information on Tyco Electronics Standard Terminals and Splices or Quick-Connect FASTON Receptacles and Tabs, request Catalog 82042.

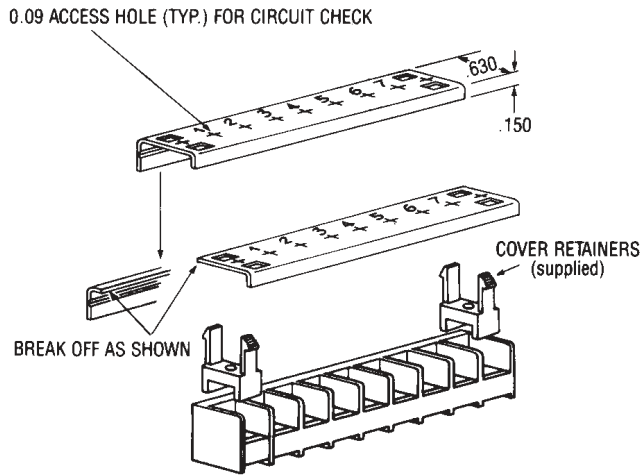

Ordering Information

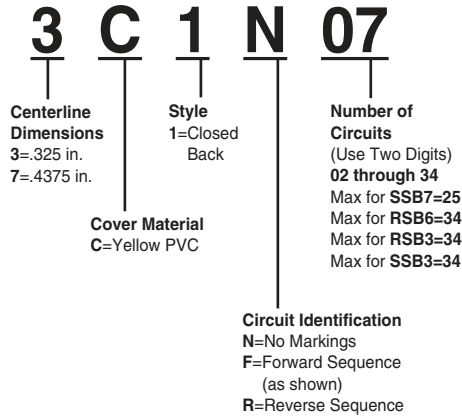

Note: All part numbers are RoHS Compliant.

Accessories — Quick-Connect (QC) Tabs

Physical Properties

Tabs

Material—Tin plated brass

Dimensions— #4 Series 0.187" wide x 0.020" thick, #6 Series 0.250" wide x 0.032" thick (0.187" x 0.020" optional), #8 Series 0.250" wide x 0.032" thick

Ordering Information: Tabs

QC4 - 180 - 3

A **B** **C**

A Style Size

QC4 = for #4 Series (45° tab angle not available)

QC6 = for #6 Series

QC8 = for #8 Series

C Tab Size

3 = 0.187 w x 0.020

4 = 0.250 w x 0.032

B Tab Angle

180 = 180° (flat)

45 = 45°

90 = 90°

Note: QC tabs may be stacked to achieve several angle configurations.



90°

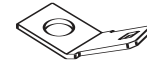

45°

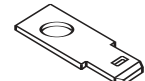

180°

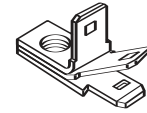

Stackable Tabs

.375" Pitch, Double Row

QUICK-CONNECT Tabs

Description	.250 wide x .032 thick		.187 wide x .032 thick	
	Part No.	Cat. No.	Part No.	Cat. No.
Flat, Two-Sided	—	1776860-1	—	1776803-1
45°, Two-Sided	∩	1776860-2	—	1776803-2
90°, Two-Sided	⌋	1776860-3	—	1776803-3
Flat, Single-Sided	—	1776843-1	—	—
45°, Single-Sided	∩	1776843-2	—	—
90°, Single-Sided	⌋	1776843-3	—	—

.563" Pitch, Double Row

QUICK-CONNECT Tabs

Description	.250 wide x .032 thick	
Part No.	Cat. No.	Part No.
Flat, Two-Sided	—	1776173-1
45°, Two-Sided	∩	1776173-2
90°, Two-Sided	⌋	1776173-3
45°/90°, Two-Sided	∩	1776173-4
Flat, Single-Sided	—	1776174-1
45°, Single-Sided	∩	1776174-2
90°, Single-Sided	⌋	1776174-3

.0325" Pitch, Series SSB3

QUICK-CONNECT Tabs

Description	.110 wide x .020 thick		.187 wide x .020 thick	
	Part No.	Cat. No.	Part No.	Cat. No.
Flat, Two-Sided	—	5-1437402-7 QC10	7-1437402-5 QC70	
45°, Two-Sided	∩	5-1437402-8 QC11	7-1437402-6 QC71	
90°, Two-Sided	⌋	5-1437402-9 QC12	7-1437402-7 QC72	
Flat, Single-Sided	—	6-1437402-0 QC13	7-1437402-8 QC73	
45°, Single-Sided	∩	6-1437402-1 QC14	7-1437402-9 QC74	
90°, Single-Sided	⌋	6-1437402-2 QC15-BU	8-1437402-0 QC75	

.375" & .4375" Pitch, Series JC6 and SSB7

QUICK-CONNECT Tabs

Description	.250 wide x .032 thick		.187 wide x .020 thick	
	Part No.	Cat. No.	Part No.	Cat. No.
Flat, Two-Sided	—	1546986-1 QC20-BU	6-1437402-9 QC40-BU	
45°, Two-Sided	∩	1546986-3 QC21	7-1437402-0 QC41	
90°, Two-Sided	⌋	1546986-4 QC22	7-1437402-1 QC42	
Flat, Single-Sided	—	6-1437402-5 QC23	7-1437402-2 QC43	
45°, Single-Sided	∩	6-1437402-6 QC24	7-1437402-3 QC44	
90°, Single-Sided	⌋	6-1437402-7 QC25	7-1437402-4 QC45	
Flat, Two-Sided, Extra-Long	—	1776090-1	—	—
90°, Two-Sided, Extra-Long	—	1776090-2	—	—
45°, Two-Sided, Extra-Long	—	1776090-3	—	—

.437" Pitch, Double Row

QUICK-CONNECT Tabs

Description	.250 wide x .032 thick	
Part No.	Cat. No.	Part No.
Flat, Two-Sided	—	1776057-3
45°, Two-Sided	∩	1776057-2
90°, Two-Sided	⌋	1776057-1
Flat, Single-Sided	—	1776110-3
45°, Single-Sided	∩	1776110-2
90°, Single-Sided	⌋	1776110-1

Related Product Data

Wire Pins and Ferrules

Pages 109-111

For more information on Tyco Electronics Standard Terminals and Splices or Quick-Connect FASTON Receptacles and Tabs, request Catalog 82042.

Solder Tabs:

For making top-side solder connections
Single-Sided

Part No.	Cat. No.
1-1437403-1	ST80

Order Number

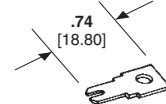

ST80

Note: All part numbers are RoHS Compliant.

Accessories — Jumpers

AROUND-THE-BARRIER

40 circuits; snap apart to desired lengths.

Spade Jumper

Catalog Number Part No.

J3140 (for 0.325" Pitch) 5-1437418-3

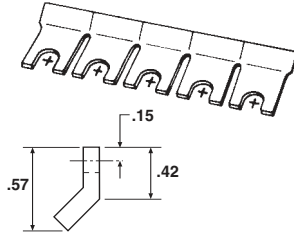

Spade Jumper

J6140 (for 0.375" Pitch and #6 Screw) 5-1437418-4

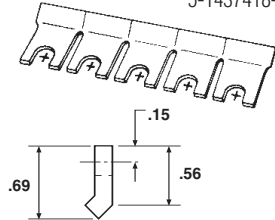

Flanged Spade Jumper

J6240 (for 0.375" Pitch and #6 Screw) 5-1437418-5

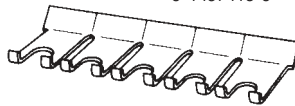

Ring Tongue Jumper

J6340 (for 0.375" Pitch and #6 Screw) 5-1437418-6

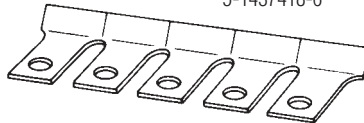

Spade Jumper

Catalog Number Part No.

J7140 (for 0.4375" Pitch and #6 Screw) 5-1437418-7

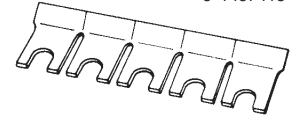

Flanged Spade Jumper

J7240 (for 0.4375" Pitch and #6 Screw) 5-1437418-8

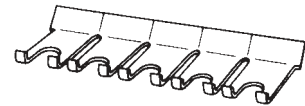

Ring Tongue Jumper

J7340 (for 0.4375" Pitch and #6 Screw) 5-1437418-9

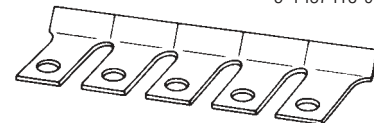

Over-the-Barrier Two Circuit (Brass, Tin Plated)

Spade Jumper

J74 (for 0.375" Pitch, Series RSB6 & SSB6; 0.4375" Pitch, SSB7) 6-1437418-0

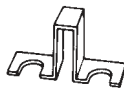

J76 (0.4375" and 0.375" Double-Row) 1776058-1

Ring Tongue Jumper

J75 (for 0.375" Pitch, Series RSB6 & SSB6; 0.4375" Pitch, SSB7) 6-1437418-1

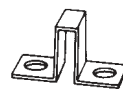

J77 (0.563" Double-Row) 1776058-1

Order Number

JX X

A

B

A Block Series

- J3 = #3 Series
- J4 = #4 Series, 4DB
- J6 = #6 Series, JC6, BC6, NC6, MB6
- J8 = #8 Series, 1546670, 1546671

B No. of Circuits (Not positions)

2 through 16

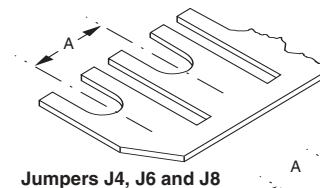

Jumpers J4, J6 and J8

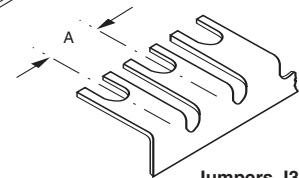



Jumpers J3

Block Series	Centerline Spacing A
J3	6,4 (0.250")
J4	8,3 (0.325")
J6	9,5 (0.375")
J8	11,1 (0.438")

Note: All part numbers are RoHS Compliant.

Accessories — Hardware & Brackets

	Catalog Number	Part Number	Description	Series	
Binding Head Screws		3L01	1437402-2	#6-32 Steel w/clear chromate	RSB3, SSB3
		L01	2-1437402-4	#6-32 Steel w/clear chromate	SSB6, SSB7, RSB6
		—	8-1437649-4	#4-40 Steel w/clear chromate	Series #4
			1437651-8	#6-32 Steel w/clear chromate	Series #6, BC6, NC6, JC6
		L03	2-1437402-6	#6-32 Stainless Steel	SSB6, SSB7, RSB6 Series #6, JC6
		L04	2-1437402-7	#6-32 Brass w/nickel plate	SSB6, SSB7, RSB6
		—	1447429-1	#8-32 Steel w/clear chromate	Series #8
Wire Clamp Screws		3L02	1437402-3	#6-32 Steel w/clear chromate	RSB3, SSB3
		L02	2-1437402-5	#6-32 Steel w/clear chromate	SSB6, SSB7, RSB6
		L09	2-1437402-8	#6-32 Brass w/nickel plate	SSB6, SSB7, RSB6
		—	8-1437649-0	#4-40 Steel w/clear chromate	Series #4
		—	1437651-5	#6-32 Brass w/nickel plate	Series #6, BC6, JC6, NC6, MB6
		—	1437651-2	#6-32 Steel w/clear chromate	Series #6, BC6, JC6, NC6, MB6
		—	1447425-1	#8-32 Steel w/clear chromate	Series #8
		—	9-1437667-9	#6-32 Steel w/clear chromate	4DB

	Catalog Number	Part No.
MOUNTING INSERTS (Nylon) for mounting RSBs with blank end sections	L91	5-1437402-1
PRESS-ON RETAINING CLIPS (Stainless Steel) for mounting turret base SSBs, JC6, and BC6	JC/BC-Retaining	1437661-7
Angle Bracket for mounting SSBs with right angle terminals, copper alloy, tin plated	L92	5-1437402-2

Note: All part numbers are RoHS Compliant.

Accessories — Standard and Custom Legends

Product Facts

- n Permanent markings, impervious to cleaning solvents per MIL-STD 202, Method 215
- n Alphabetical and numerical legending
- n Numbers and characters can be in any order
- n Size and spacing of characters may be tailored to your application
- n White markings standard
- n Custom legends available on special request

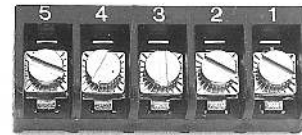
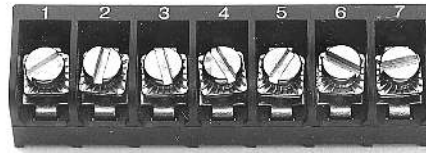

Custom legending can lend a personal touch to your product...helps in circuit identification and makes wiring faster and easier. Alphabetical and numerical markings are available in either standard or custom styles to best suit your specific applications. Legending is available to the styles depicted below.

Standard Legending Arrangements

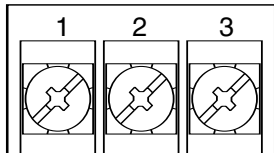

Style A1

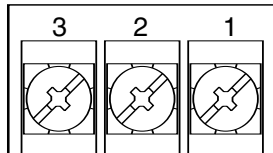

Style B1

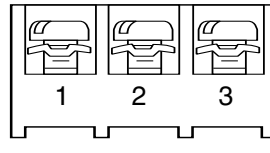

Style C1

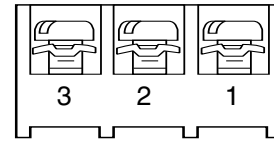

Style D1

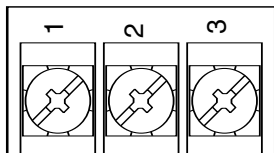

Style A2

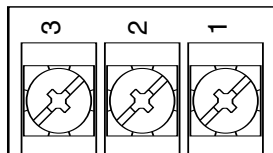

Style B2

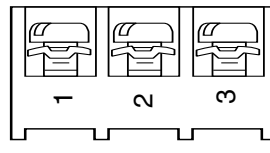

Style C2

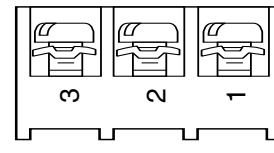

Style D2

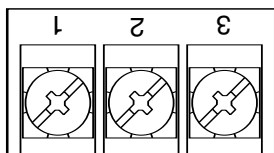

Style A3

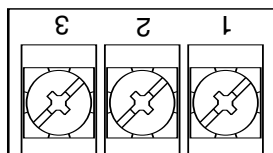

Style B3

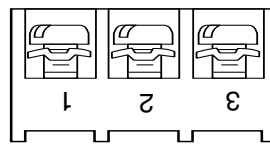

Style C3

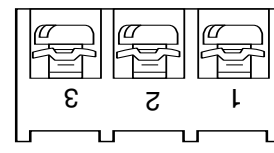

Style D3

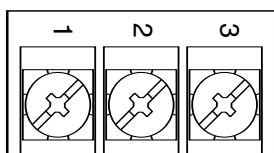

Style A4

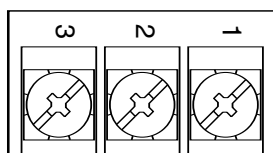

Style B4

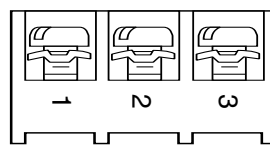

Style C4

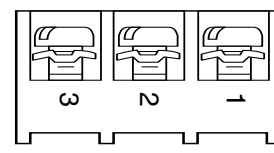

Style D4

Note: All part numbers
are RoHS Compliant.

Engineering Notes



Note: All part numbers are RoHS Compliant.

Table of Contents—Card Edge

Series PCB1A.....	182
Series PCB1B.....	183
Series PCB2B.....	184
Series PCB3A.....	185
Series PCB3S.....	186
Series PCB3D	187
Series PCB5B.....	188
45° Eurostyle Series	189, 190
Series PSB	191, 192
Series PCB Accessories	193
Series PSB Accessories	194

Note: All part numbers are RoHS Compliant.

0.200" [5.08] Pitch PCB1A Series

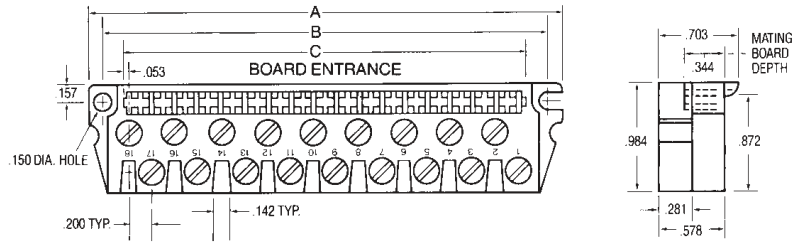

Recommended PC Board Layout

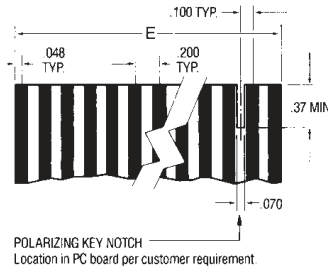

Material & Finish

- Housing Material**—Polyester
- Flammability**—UL94V-0
- Color**—White
- Tubular Contact**—Brass
- PC Contact**—Phosphor Bronze with Bright Tin or Gold over Nickel plating
- Screw**—Steel with Zinc + Chromate plating
- Clamp**—Brass

Mechanical Properties

- Pitch (Terminal Spacing)**— .200" [5.08]
- Screw Size**—6-32
- Mounting Screw Size**—#4 or #6
- Wire Strip Length**—.25" [6.35]
- Recommended Tightening Torque**—5-8 in.-lbs.
- Recommended Screwdrivers**— Xcelite R184, Sears Craftsman 41429, Stanley 1016
- Board Insertion Force (Typ.) per Ckt.**— 5.6 oz. [160g]
- Board Separation Force (Typ.) per Ckt.**— 1.8 oz. [50g]
- Durability**—Passes MIL-C-21097: 500 cycles

Electrical Properties

- Maximum Current**—10A
- Operating Voltage**—250V
- Wire Range**—#12 Stranded Only
- Dielectric Withstand**— 2500V
- Insulation Resistance**—10¹¹ ohms
- Contact Resistance**— 6 milliohms

Environmental Properties

- Operating Temperature Range**— -65°C to +140°C [-85°F to +284°F]

No. of Positions	Dimensions				Part Number	Catalog Number*
	A	B	C	E		
12	2.920 [74.17]	2.670 [67.82]	2.310 [58.67]	2.295 [58.29]	1437410-9	PCB1A12S
18	4.120 [104.65]	3.870 [98.30]	3.510 [89.15]	3.495 [88.77]	1-1437410-1	PCB1A18S
24	5.320 [134.62]	5.070 [128.78]	4.710 [119.63]	4.695 [119.25]	1-1437410-3	PCB1A24S
30	6.520 [165.61]	6.270 [159.26]	5.910 [150.11]	5.895 [149.73]	1-1437410-5	PCB1A30S
36	7.720 [196.09]	7.470 [189.74]	7.110 [180.59]	7.095 [180.21]	1-1437410-7	PCB1A36S

*Note: For optional Gold-over-Nickel plating on contacts (instead of standard Bright Tin) change the letter "S" of the Catalog Number to "A".



Note: All part numbers are RoHS Compliant.

0.156" [3.96] Pitch PCB1B Series

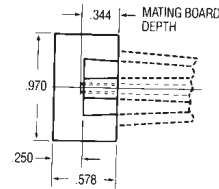
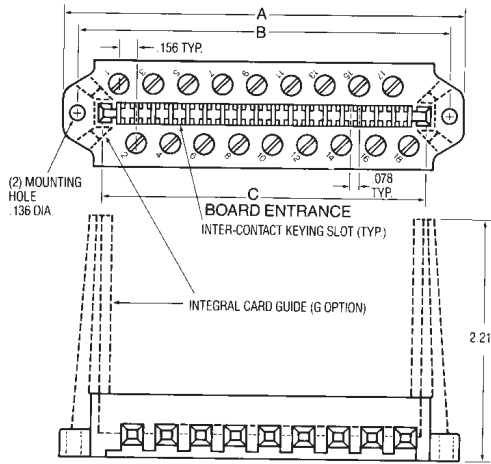

Recommended PC Board Layout

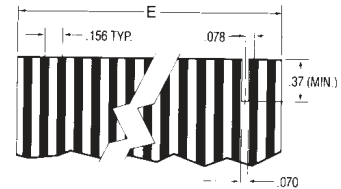

POLARIZING KEY NOTCH
Location in PC board per customer requirement.

Material & Finish

- Housing Material**—Polyester
- Flammability**—UL94V-0
- Color**—Black
- Tubular Contact**—Brass
- PC Contact**—Phosphor Bronze with Bright Tin or Gold over Nickel plating
- Screw**—Steel with Zinc + Chromate plating
- Clamp**—Brass

Mechanical Properties

- Pitch (Terminal Spacing)**—
.156" [3.96]
- Screw Size**—6-32
- Mounting Screw Size**—#4 or #6
- Wire Range**—#14 Sol/Str Only
- Wire Strip Length**—.25" [6.35]
- Recommended Tightening Torque**—5-8 in.-lbs.
- Recommended Screwdrivers**—
Xcelite R184, Sears Craftsman 41429, Stanley 1016
- Board Insertion Force (Typ.) per Ckt.**— 5.6 oz. [160g]
- Board Separation Force (Typ.) per Ckt.**— 1.8 oz. [50g]
- Durability**—Passes MIL-C-21097: 500 cycles

Electrical Properties

- Maximum Current**—10A
- Operating Voltage**—250V
- Wire Range**—#14 Sol/Str Only
- Dielectric Withstand**—3000V
- Insulation Resistance**—10¹¹ ohms
- Contact Resistance**—6 milliohms

Environmental Properties

- Operating Temperature Range**—
-65°C to +140°C [-85°F to +284°F]

No. of Positions	Dimensions				Part Number	Catalog Number*
	A	B	C	E		
06	1.786 [45.36]	1.536 [39.01]	1.100 [27.94]	1.085 [27.56]	1-1437410-8	PCB1B06S
08	2.098 [53.29]	1.848 [46.94]	1.412 [35.86]	1.397 [35.48]	2-1437410-0	PCB1B08S
10	2.410 [61.21]	2.160 [54.86]	1.724 [43.79]	1.709 [43.41]	2-1437410-3	PCB1B10S
12	2.722 [69.14]	2.472 [62.79]	2.036 [51.71]	2.021 [51.33]	2-1437410-7	PCB1B12S
15	3.190 [81.03]	2.940 [74.68]	2.504 [63.60]	2.489 [63.22]	3-1437410-1	PCB1B15S
16	3.351 [85.12]	3.096 [78.64]	2.660 [67.56]	2.645 [67.18]	1776774-8	PCB1B16S
18	3.658 [92.91]	3.408 [86.56]	2.972 [75.49]	2.957 [75.11]	3-1437410-6	PCB1B18S
22	4.282 [108.76]	4.032 [102.41]	3.596 [91.34]	3.581 [90.96]	4-1437410-0	PCB1B22S
24	4.599 [116.81]	4.344 [110.34]	3.908 [99.26]	3.893 [98.88]	1776774-7	PCB1B24S
28	5.218 [132.54]	4.968 [126.19]	4.544 [115.42]	4.517 [122.66]	4-1437410-4	PCB1B28S
30	5.533 [140.54]	5.280 [134.11]	4.844 [123.04]	4.829 [122.66]	1776774-1	PCB1B30S
32	5.842 [148.39]	5.592 [142.04]	5.156 [130.96]	5.141 [130.58]	4-1437410-9	PCB1B32S
36	6.466 [164.24]	6.216 [157.89]	5.780 [146.81]	5.765 [146.43]	5-1437410-3	PCB1B36S
43	7.558 [191.97]	7.308 [185.62]	6.872 [174.55]	6.857 [174.17]	5-1437410-7	PCB1B43S

*Note: For optional Gold-over-Nickel plating on contacts (instead of standard bright tin), change the letter "S" of the Catalog Number to "A". For optional integral card guides, add the letter "G" to the end of the catalog number.



Note: All part numbers are RoHS Compliant.

0.156" [3.96] Pitch PCB2B Series

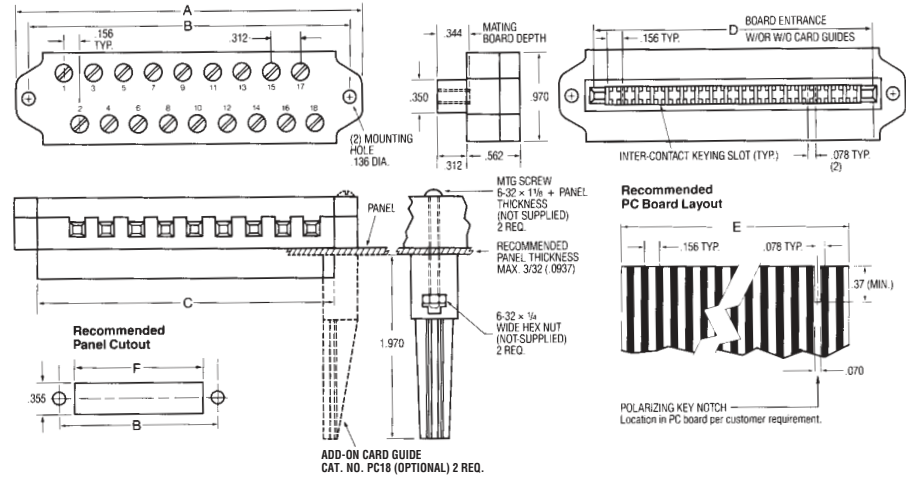

Material & Finish

- Housing Material**—Polyester
- Flammability**—UL94V-0
- Color**—Black
- Tubular Contact**—Brass
- PC Contact**—Phosphor Bronze with Bright Tin or Gold over Nickel plating
- Screw**—Steel with Zinc + Chromate plating
- Clamp**—Brass

Mechanical Properties

- Pitch (Terminal Spacing)**—
.156" [3.96]
- Screw Size**—#6-32
- Mounting Screw Size**—#4 or #6
- Wire Strip Length**—.25" [6.35]
- Recommended Tightening Torque**—5-8 in.-lbs.
- Recommended Screwdrivers**—
Xcelite R184, Sears Craftsman 41429, Stanley 1016
- Board Insertion Force (Typ.) per Ckt.**—5.6 oz. [160g]
- Board Separation Force (Typ.) per Ckt.**—1.8 oz. [50g]
- Durability**—Passes MIL-C-21097: 500 cycles

Electrical Properties

- Maximum Current**—10A
- Operating Voltage**—250V
- Wire Range**—#16 Sol/Str Only
- Dielectric Withstand**—3000V
- Insulation Resistance**—10¹¹ ohms
- Contact Resistance**—6 milliohms
- Environmental Properties**
- Operating Temperature Range**—
-65°C to +140°C [-85°F to +284°F]

No. of Positions	Dimensions								Part Number	Catalog Number*
	A	B	C	D	E	F (Min.)				
06	1.786 [45.36]	1.536 [39.01]	1.264 [32.11]	1.100 [27.94]	1.085 [27.56]	1.284 [32.61]			6-1437410-1	PCB2B06S
08	2.098 [53.29]	1.848 [46.94]	1.576 [40.03]	1.412 [35.86]	1.397 [35.48]	1.596 [40.54]			6-1437410-3	PCB2B08S
09	2.254 [57.25]	2.004 [50.90]	1.732 [43.99]	1.568 [39.83]	1.553 [39.45]	1.752 [44.50]			6-1437410-4	PCB2B09S
10	2.410 [61.21]	2.160 [54.86]	1.888 [47.96]	1.724 [43.79]	1.709 [43.41]	1.908 [48.46]			6-1437410-6	PCB2B10S
12	2.722 [69.14]	2.472 [62.79]	2.200 [55.88]	2.036 [51.71]	2.021 [51.33]	2.220 [56.39]			6-1437410-8	PCB2B12S
15	3.190 [81.03]	2.940 [74.68]	2.668 [67.77]	2.504 [63.60]	2.489 [63.22]	2.688 [68.28]			7-1437410-0	PCB2B15S
16	3.346 [84.99]	3.096 [78.64]	2.824 [71.73]	2.660 [67.56]	2.645 [67.41]	2.844 [72.24]			7-1437410-2	PCB2B16S
18	3.658 [92.91]	3.408 [86.56]	3.136 [79.65]	2.972 [75.49]	2.957 [75.11]	3.156 [80.16]			7-1437410-4	PCB2B18S
22	4.282 [108.76]	4.032 [102.41]	3.760 [95.50]	3.596 [91.34]	3.581 [90.96]	3.780 [96.01]			7-1437410-6	PCB2B22S
24	4.594 [116.69]	4.344 [110.34]	4.072 [103.43]	3.908 [99.26]	3.893 [98.88]	4.092 [103.94]			—	PCB2B24S
28	5.218 [132.54]	4.968 [126.19]	4.696 [119.28]	4.532 [115.11]	4.517 [114.73]	4.716 [119.79]			7-1437410-9	PCB2B28S
30	5.530 [140.46]	5.280 [134.11]	5.008 [127.20]	4.844 [123.09]	4.829 [122.66]	5.028 [127.71]			8-1437410-1	PCB2B30S
36	6.466 [164.24]	6.216 [157.89]	5.944 [150.98]	5.780 [146.81]	5.765 [146.43]	5.964 [151.49]			8-1437410-3	PCB2B36S
43	7.558 [191.97]	7.308 [185.62]	7.036 [178.71]	6.872 [174.55]	6.857 [174.17]	7.056 [179.22]			8-1437410-5	PCB2B43S

*Note: For optional Gold-over-Nickel plating on contacts (instead of standard bright tin), change the letter "S" of the Catalog Number to "A".



Note: All part numbers are RoHS Compliant.

0.200" [5.08] Pitch PCB3A Series



Material & Finish

Housing Material—Polyester

Flammability—UL94V-0

Color—Black

Tubular Contact—Brass

PC Contact—Phosphor Bronze with Bright Tin or Gold over Nickel plating

Screw—Steel with Zinc + Chromate plating

Clamp—Brass

Mechanical Properties

Pitch (Terminal Spacing)— .200" [5.08]

Screw Size—#6-32

Mounting Screw Size—#6

Wire Strip Length—.25" [6.35]

Recommended Tightening Torque—5-8 in.-lbs.

Recommended Screwdrivers— Xcelite R184, Sears Craftsman 41429, Stanley 1016

Board Insertion Force (Typ.) per Ckt.— 5.6 oz. [160g]

Board Separation Force (Typ.) per Ckt.— 1.8 oz. [50g]

Durability—Passes MIL-C-21097: 500 cycles

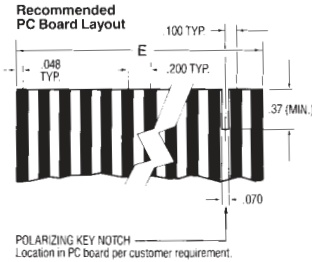
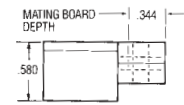
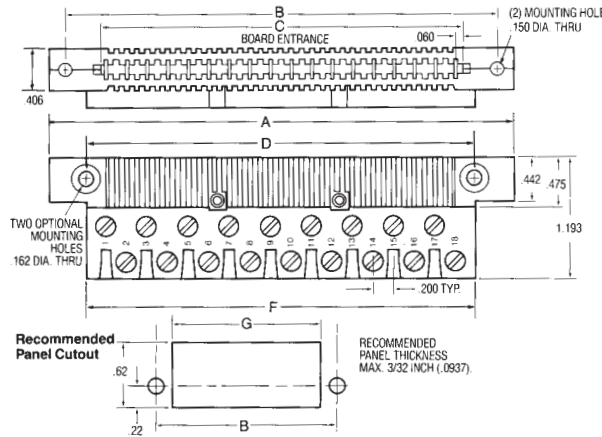

Electrical Properties

Maximum Current—10A

Operating Voltage—250V

Wire Range—1 or 2 #18 Sol/Str

Dielectric Withstand—2500V

Insulation Resistance—10¹¹ ohms

Contact Resistance—6 milliohms

Environmental Properties

Operating Temperature Range— -65°C to +140°C [-85°F to +284°F]

No. of Positions	Dimensions							Part Number	Catalog Number*
	A	B	C	D & F	E	G			
06	2.150 [54.61]	1.800 [45.72]	1.120 [28.45]	1.400 [35.56]	1.105 [28.07]	1.43 [36.32]	8-1437410-8	PCB3A06S	
08	2.550 [64.77]	2.200 [55.88]	1.520 [38.61]	1.800 [45.72]	1.505 [38.23]	1.83 [46.48]	9-1437410-0	PCB3A08S	
10	2.950 [74.93]	2.600 [66.09]	1.920 [48.26]	2.200 [55.88]	1.905 [48.39]	2.23 [56.64]	9-1437410-2	PCB3A10S	
12	3.350 [85.09]	3.000 [76.20]	2.320 [58.93]	2.600 [66.09]	2.305 [58.55]	2.63 [66.80]	9-1437410-4	PCB3A12S	
15	3.950 [100.33]	3.600 [91.44]	2.920 [74.17]	3.200 [81.28]	2.905 [73.79]	3.23 [82.04]	9-1437410-6	PCB3A15S	
16	4.150 [105.41]	3.800 [96.52]	3.120 [79.25]	3.400 [86.38]	3.105 [78.87]	3.43 [87.12]	9-1437410-8	PCB3A16S	
18	4.550 [115.57]	4.200 [106.68]	3.520 [89.41]	3.800 [96.52]	3.505 [89.03]	3.83 [97.28]	1437411-2	PCB3A18S	
20	4.950 [125.73]	4.600 [116.84]	3.920 [99.57]	4.200 [106.68]	3.905 [99.19]	4.23 [107.44]	2-1546107-0	PCB3A20S	
22	5.350 [135.89]	5.000 [127.00]	4.320 [109.73]	4.600 [116.84]	4.305 [109.35]	4.63 [117.60]	1437411-4	PCB3A22S	
24	5.750 [146.05]	5.400 [137.16]	4.720 [119.89]	5.000 [127.00]	4.705 [119.51]	5.03 [127.76]	1437411-6	PCB3A24S	
30	6.950 [176.53]	6.600 [167.64]	5.920 [150.37]	6.200 [157.48]	5.905 [149.99]	6.23 [158.24]	1437411-8	PCB3A30S	
32	7.350 [186.69]	7.000 [177.80]	6.320 [160.53]	6.600 [167.64]	6.305 [160.15]	6.63 [168.40]	1-1437411-0	PCB3A32S	
34	7.750 [196.85]	7.400 [187.96]	6.720 [170.69]	7.000 [177.80]	6.705 [170.31]	7.03 [178.56]	3-1546107-4	PCB3A34S	
36	8.150 [207.01]	7.800 [198.12]	7.120 [180.85]	7.400 [187.96]	7.105 [180.47]	7.43 [188.72]	1-1437411-3	PCB3A36S	
44	9.750 [247.65]	9.400 [238.49]	8.720 [221.49]	9.000 [228.60]	8.705 [221.11]	9.03 [209.36]	1-1437411-5	PCB3A44S	

*Note: For optional Gold-over-Nickel plating on contacts (instead of standard bright tin), change the letter "S" of the Catalog Number to "A".



Note: All part numbers are RoHS Compliant.

0.156" [3.96] Pitch PCB3S Series



Material & Finish

- Housing Material**—Polyester
- Flammability**—UL94V-0
- Color**—Black
- Tubular Contact**—Brass
- PC Contact**—Phosphor Bronze with Bright Tin or Gold over Nickel plating
- Screw**—Steel with Zinc + Chromate plating
- Clamp**—Brass

Mechanical Properties

- Pitch (Terminal Spacing)**—
.156" [3.96]
- Screw Size**—#6-32
- Mounting Screw Size**—#6
- Wire Strip Length**—.66" [16.76]
- Recommended Tightening Torque**—5-8 in.-lbs.
- Recommended Screwdrivers**—
Xcelite R184, Sears Craftsman 41429, Stanley 1016
- Board Insertion Force (Typ.) per Ckt.**—5 oz. [140g]
- Board Separation Force (Typ.) per Ckt.**—1.5 oz. [42g]
- Durability**—Passes MIL-C-21097: 500 cycles

Electrical Properties

- Maximum Current**—10A
- Operating Voltage**—250V
- Wire Range**—#18-22 AWG
- Dielectric Withstand**—2000V
- Insulation Resistance**—10¹¹ ohms
- Contact Resistance**—10 milliohms

Environmental Properties

- Operating Temperature Range**—
-65°C to +140°C [-85°F to +284°F]

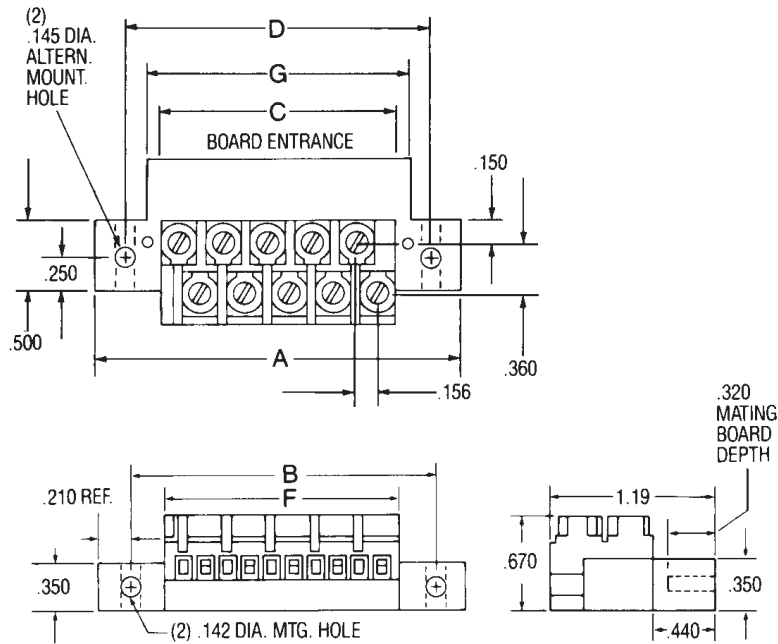

Recommended PC Board Layout

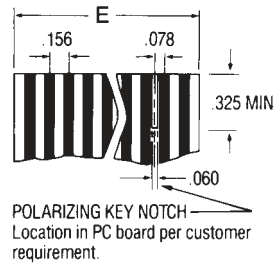

*Note: .062" [1.57] PC Board thickness.
.156" [3.96] contact centerline spacing for single- & double-sided boards.

No. of Positions	Dimensions							Part Number	Catalog Number*
	A	B & D	C	E	F	G			
10	2.59 [65.79]	2.16 [54.86]	1.73 [43.94]	1.71 [43.43]	1.65 [41.91]	1.85 [46.99]	1-1546928-0	PCB3S10S	
15	3.37 [85.60]	2.95 [74.93]	2.51 [63.75]	2.50 [63.50]	2.43 [61.72]	2.64 [67.06]	2-1437411-6	PCB3S15S	
18	3.84 [97.54]	3.41 [86.61]	2.98 [75.69]	2.97 [75.44]	2.90 [73.66]	3.11 [78.99]	1-1546928-8	PCB3S18S	
22	4.47 [113.54]	4.04 [102.62]	3.60 [91.44]	3.59 [91.19]	3.54 [89.92]	3.73 [94.74]	2-1437411-9	PCB3S22S	

*Note: For optional Gold-over-Nickel plating on contacts (instead of standard bright tin), change the letter "S" of the Catalog Number to "A".



Note: All part numbers are RoHS Compliant.

0.156" [3.96] Pitch PCB3D Series, Double-Sided



Material & Finish

- Housing Material**—Polyester
- Flammability**—UL94V-0
- Color**—Black
- Tubular Contact**—Brass
- PC Contact**—Phosphor Bronze
- Screw**—Steel with Zinc + Chromate plating
- Clamp**—Brass

Mechanical Properties

- Pitch (Terminal Spacing)**—
.156" [3.96]
- Screw Size**—#6-32
- Mounting Screw Size**—#6
- Wire Strip Length**—.66" [16.76]
- Recommended Tightening Torque**—5-8 in.-lbs.
- Recommended Screwdrivers**—
Xcelite R184, Sears Craftsman 41429,
Stanley 1016
- Board Insertion Force (Typ.) per Ckt.**—5 oz. [140g]
- Board Separation Force (Typ.) per Ckt.**—1.5 oz. [42g]
- Durability**—Passes MIL-C-21097:
500 cycles

Electrical Properties

- Maximum Current**—10A
- Operating Voltage**—250V
- Wire Range**—#16 Sol/Str
- Dielectric Withstand**—2000V
- Insulation Resistance**—10¹¹ ohms
- Contact Resistance**—10 milliohms

Environmental Properties

- Operating Temperature Range**—
-65°C to +140°C [-85°F to +284°F]

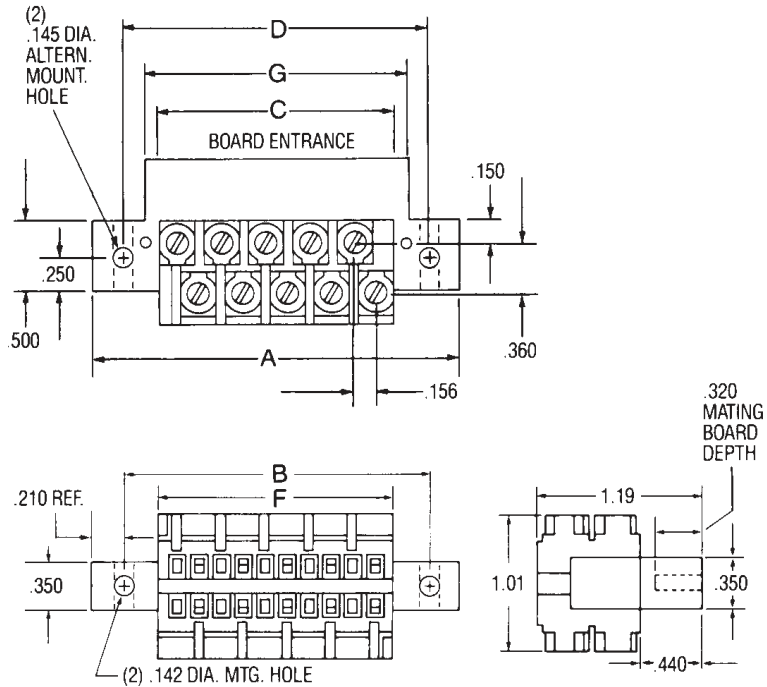

Recommended PC Board Layout

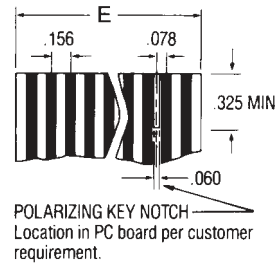

*Note: .062" [1.57] PC Board thickness.
.156" [3.96] contact centerline spacing for single- & double-sided boards.

No. of Positions	Dimensions							Part Number	Catalog Number*
	A	B & D	C	E	F	G			
20	2.59 [65.79]	2.16 [54.86]	1.73 [43.94]	1.71 [43.43]	1.65 [41.91]	1.85 [46.99]	1-1437411-7	PCB3D20S	
30	3.37 [85.60]	2.95 [74.93]	2.51 [63.75]	2.50 [63.50]	2.43 [61.72]	2.64 [67.06]	1-1437411-9	PCB3D30S	
36	3.84 [97.54]	3.41 [86.61]	2.98 [75.69]	2.97 [75.44]	2.90 [73.66]	3.11 [78.99]	2-1437411-1	PCB3D36S	
44	4.47 [113.54]	4.04 [102.62]	3.60 [91.44]	3.59 [91.19]	3.54 [89.92]	3.73 [94.74]	2-1437411-3	PCB3D44S	

*Note: For optional Gold-over-Nickel plating on contacts (instead of standard bright tin), change the letter "S" of the Catalog Number to "A".



Note: All part numbers are RoHS Compliant.

0.156" [3.96] Pitch PCB5B Series

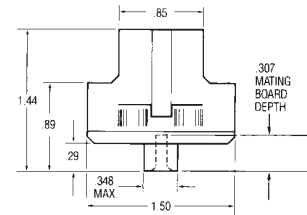
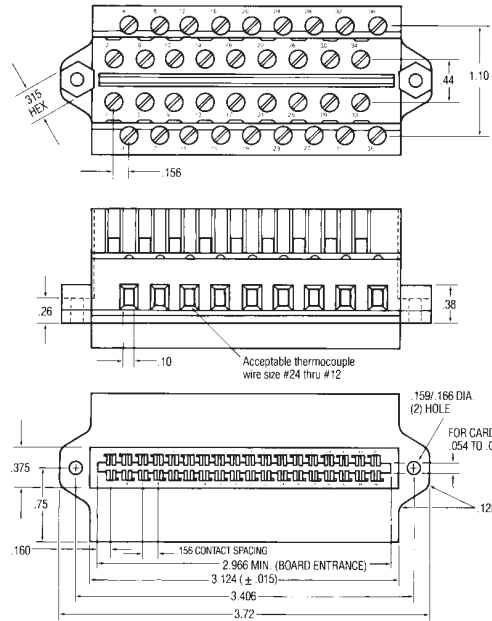
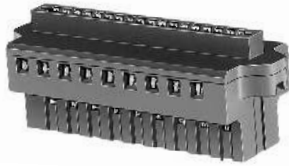

Recommended PC Board Layout

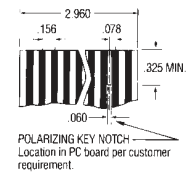

Material & Finish

- Housing Material**—Polyester
- Flammability**—UL94V-0
- Color**—Black
- Tubular Contact**—Brass
- PC Contact**—Phosphor Bronze
- Screw**—Steel with Zinc + Chromate plating
- Clamp**—Brass

Mechanical Properties

Pitch (Terminal Spacing)—
.156" [3.96]

Screw Size—#6-32

Mounting Screw Size—#6

Wire Strip Length—.25" [6.35]

Recommended Tightening Torque—5-8 in.-lbs.

Recommended Screwdrivers—
Xcelite R184, Sears Craftsman 41429, Stanley 1016

Board Insertion Force (Typ.) per Ckt.—7.6 oz. [215g]

Board Separation Force (Typ.) per Ckt.—1.2 oz. [35g]

Durability—Passes MIL-C-21097: 500 cycles

Electrical Properties

Maximum Current—5A

Operating Voltage—250V

Wire Range—#12 Stranded Only

Dielectric Withstand—1500V

Insulation Resistance—10¹¹ ohms

Contact Resistance—10 milliohms

Environmental Properties

Operating Temperature Range—
-65°C to +140°C [-85°F to +284°F]

Description	Part Number	Catalog Number
Standard	3-1437411-0	PCB5B36A

Note: All part numbers are RoHS Compliant.

.197 [5.00] Pitch 45° Eurostyle Series

Product Facts

- n Gold-plated phosphor bronze contacts
- n 5 A current rating at 250 VAC
- n Max. wire size: 14-12 AWG [2 - 2.6 mm²]
- n Centerline: 5.0 mm
- n Simple to rewire, even when board mounted
- n Easy access to zinc-plated screw terminals
- n Anti-overstress protection from panel mount latch
- n Stackable
- n Test probe facility
- n Polarized housings
- n Keying plugs

Product Specification:
108-3177

Application Specification:
114-3149

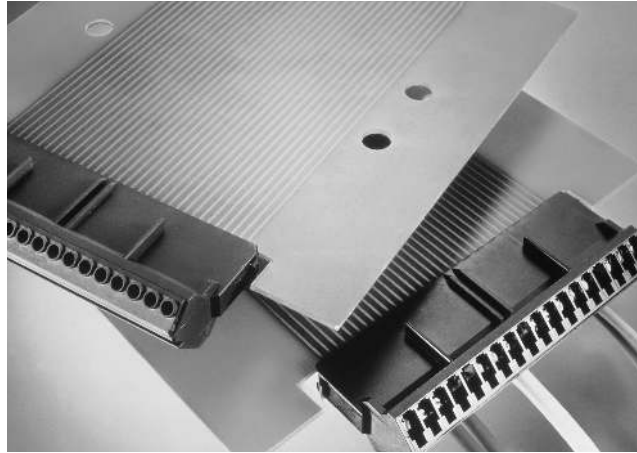

Example: 18-Position Version

This input/output connector can be easily installed or removed from the pc board. The connector is available on 5.0 mm centerline, fully polarized and specially designed to minimize thermal gradient across the panel.

The screw clamp terminal makes rewiring the connector simple, even when installed on the pc board, as no special tooling is required.

Bifurcated, gold-plated phosphor bronze contacts promote excellent signal conductivity and reliability.

No. of Positions	Part Numbers
8	347528-1
12	347601-1
16	346218-1
18	346220-1
20	347529-1

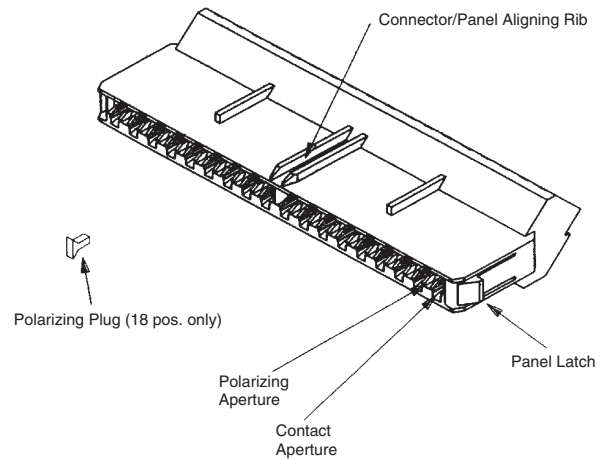
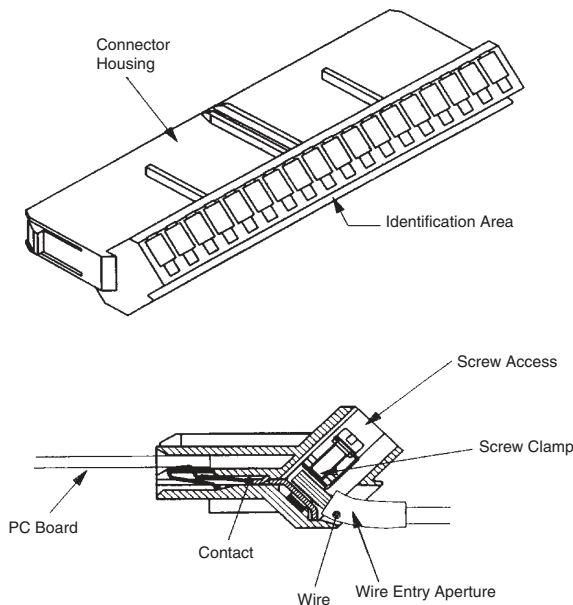

Note: All part numbers are RoHS Compliant.

.197 [5.00] Pitch 45° Eurostyle Series (Continued)

Material & Finish

Housing Material—Polycarbonate, black, glass-filled, UL 94V-0 rated

Contact Material—Phosphor bronze, gold plated

Screw Clamp—Steel, zinc plated

Accepted Wire Sizes—2.0–2.6 mm² (14–12 AWG)

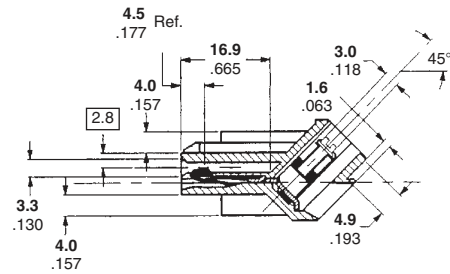
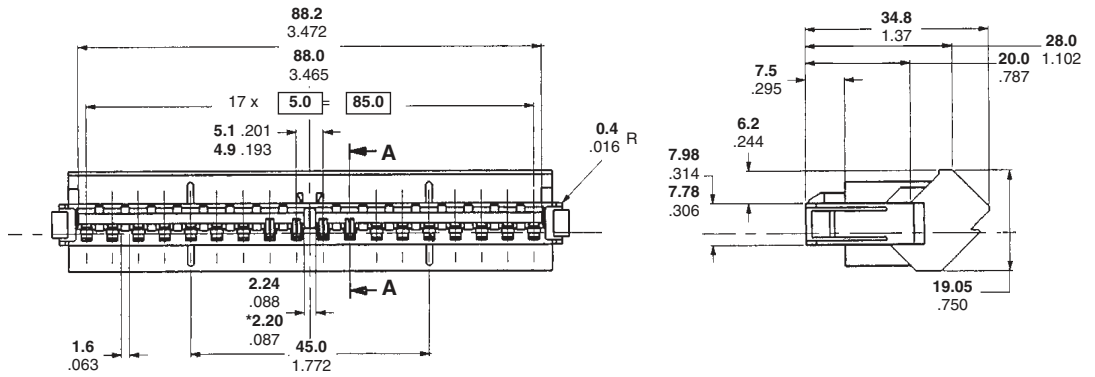
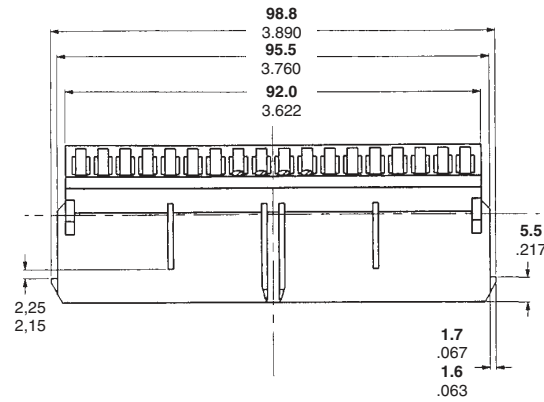

Section A-A

18-position shown, Part Number 346220-1
*Dimension for Polarizing Plug, 18-position only.

Note: All part numbers are RoHS Compliant.

0.375" [9.53] Pitch Series PSB

Material & Finish

- Housing Material**—Noryl
- Color**—Black
- Flammability**—UL94V-0
- PC Contact**—Phosphor Bronze with Bright Tin or Gold over Nickel plating
- Screw Contact**—Phosphor Bronze with Bright Tin or Gold over Nickel plating
- Screw**—Steel with Zinc plating

Mechanical Properties

- Pitch (Terminal Spacing)**—
.375" [9.53]
- Screw Size**—6-32
- Mounting Screw**—#6
- Wire Strip Length**—
.31" [7.87]
- Wire Lug Width**—
.320" [8.1mm]
- Recommended Tightening Torque**—
9 in.-lbs.
- Recommended Screwdrivers**—
Stanley 1006-4, Sears Craftsman 41581, Any #2 Phillips-Head
- Board Inspection Force (Typ.) per Ckt.**—
6 oz. [170g]
- Board Separation Force (Typ.) per Ckt.**—
2 oz. [57g]
- Durability**—
Passes MIL-C-21097: 500 cycles

Electrical Properties

- Maximum Current**—10A
- Operating Voltage**—300V, 600V (limited rating)
- Wire Range**—#12-26 AWG
- Dielectric Withstand**—3000V
- Insulation Resistance**— 10^{11} ohms
- Contact Resistance**—5 milliohms

Environmental Properties

- Operating Temperature Range**—
-60°C to +95°C [-76°F to +203°F]

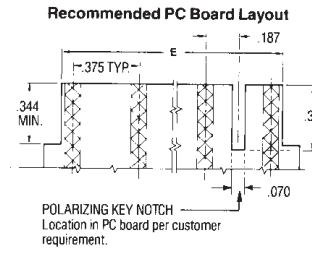
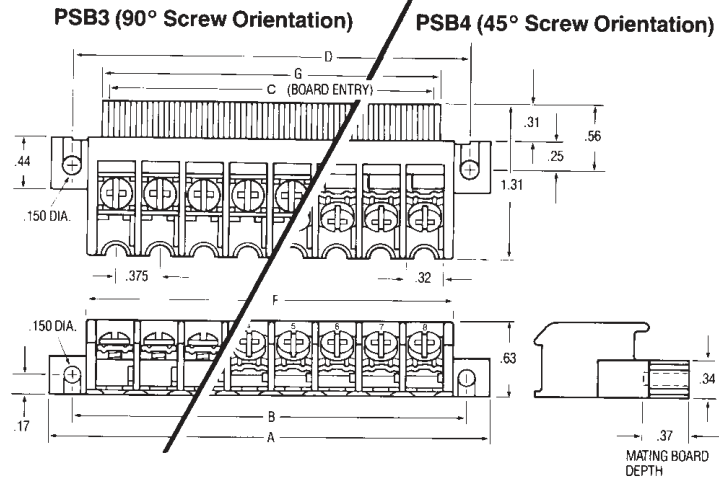

No. of Positions	Dimensions						
	A	B & D	C	E	F	G	
06	3.00 [76.20]	2.625 [66.68]	2.000 [50.80]	1.990 [50.55]	2.36 [59.94]	2.16 [54.86]	
08	3.75 [95.25]	3.375 [85.73]	2.750 [69.85]	2.740 [69.60]	3.11 [78.99]	2.91 [73.91]	
10	4.50 [114.30]	4.125 [104.78]	3.500 [88.90]	3.490 [88.65]	3.86 [98.04]	3.66 [92.96]	
12	5.25 [133.35]	4.875 [123.83]	4.250 [107.95]	4.240 [107.70]	4.61 [117.09]	4.41 [112.01]	
14	6.00 [152.40]	5.625 [142.88]	5.000 [127.00]	4.990 [126.75]	5.36 [136.14]	5.16 [131.06]	
16	6.75 [171.45]	6.375 [161.93]	5.750 [146.05]	5.740 [145.80]	6.11 [155.19]	5.91 [151.11]	
18	7.50 [190.50]	7.125 [180.98]	6.500 [165.10]	6.490 [164.85]	6.86 [174.24]	6.66 [169.16]	
20	8.25 [209.55]	7.875 [200.03]	7.250 [184.15]	7.235 [183.77]	7.61 [193.29]	7.41 [188.21]	
22	9.00 [228.60]	8.625 [219.08]	8.000 [203.20]	7.985 [202.82]	8.36 [212.34]	8.16 [207.26]	
24	9.75 [247.65]	9.375 [238.13]	8.750 [222.25]	8.735 [221.87]	9.11 [231.39]	8.91 [226.31]	

0.375" [9.53] Pitch Series PSB (Continued)

Ordering Information

PSB 3 K B 08 S NN NN
A B C D E F G H

A PSB Printed Circuit Board Connector

B Terminal Screw Orientation

3 = 90°

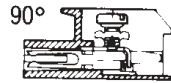

4 = 45°



C Contact Spacing

K = .375 (3/8)

D Terminal Screw Type

C = #6 Phil-slot steel screw and clamp

E Number of Circuits

06 through 24 (even numbers only)

F Terminal Plating

(not screw)

A = Gold

S = Bright Tin

G Top Hardware Options

NN = No optional hardware

QUICK-CONNECT BLADES

.250 [6.35] wide x.032 [.81] thick	.187 wide [4.75] x.020 [.51] thick	
21	41=	*
22	42=	*
23	43=	**
24	44=	
25	45=	
29	49=	**
30	50=	**
31	51=	**
34	54=	*
35	55=	
36	56=	*

* PSB4K only
** PSB3K only

80 = Single-Sided Solder Tab (PSB3K only)





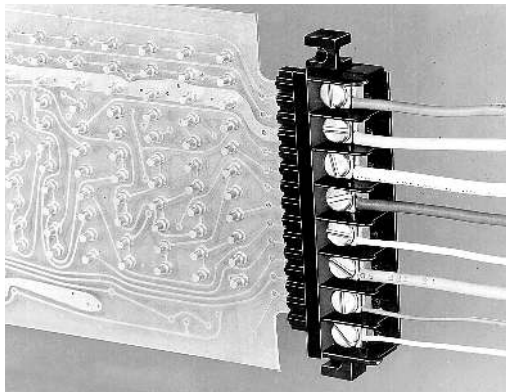
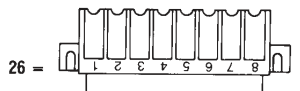
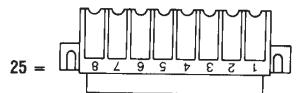
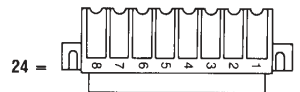
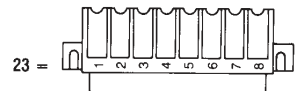
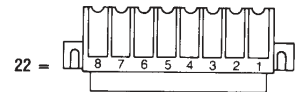
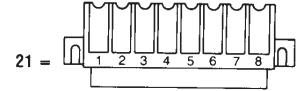

H Circuit Identification Option

NN = No circuit identification

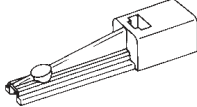

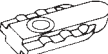
Note: All part numbers are RoHS Compliant.

Accessories for Series PCB

Description		Catalog Number	Part Number
Add-on Card Guide (Nylon)			
for PCB2B, PCB3D and PCB3S		PC18	6-1437418-2
Polarizing Keys (Nylon) for PCB1A, 1B, 2B, 3A,			
		PC17	1437410-5
for PCB3D, 3S, 5B		PC19	1437410-6
Two-Circuit Jumper			
for PCB1B, PCB2B and PCB5B		PCBJ1	6-1437418-4
for PCB1A and PCB3A		PCBJ2	6-1437418-5
for PCB3D and PCB3S		PCBJ3	—

Note: All part numbers are RoHS Compliant.

Accessories for Series PSB

Description	Part Number	Catalog Number
Polarizing Key	1437410-5	PC17
QUICK-CONNECT Tabs	.250 [6.35] wide x .032 [.81] thick	.187 [4.75] wide x .020 thick [.51]
	Part No.	Cat. No.
45°, Two-sided (PSB4K only)	6-1437418-6	QC21
90°, Two-sided (PSB4K only)	6-1437402-4	QC22
Flat, Single-sided (PSB3K only)	6-1437402-5	QC23
45°, Single-sided	6-1437402-6	QC24
90°, Single-sided	6-1437402-7	QC25
Solder Tab (PSB3K)	1-1437403-1	ST80
Over-the-Barrier Jumpers (Two-Circuit) Spade	6-1437418-0	J74
Ring Tongue	6-1437418-1	J75

Description	Part Number	Catalog Number
Around-the-Barrier Jumpers* Spade 40 ckt, snap apart to desired lengths	5-1437418-4	J6140
Flanged Spade 40 ckt, snap apart to desired lengths	5-1437418-5	J6240
Ring Tongue 40 ckt, snap apart to desired lengths	5-1437418-6	J6340

*Note: Jumper extends 0.54 horizontally from center of screw.

Related Product Data

Wire Pins and Ferrules—Pages 135-137
For more information on AMP Standard Terminals and Splices or Quick-Connect FASTON Receptacles and Tabs, request Catalog 82042.

Covers for Series PSB

Housing Material—PVC (50° temp. index)

Flammability—UL94V-0

Color—Black

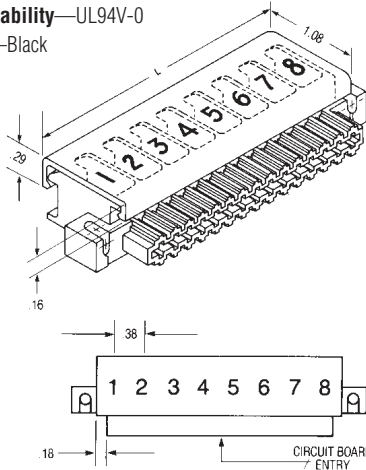

No. of Positions	Dim. L	Part Number	Catalog Number*
06	2.41 [61.21]	1-1437409-4	PSB3KCC06
08	3.16 [80.26]	3-1437406-4	PSB3KCC08
10	3.91 [99.31]	1437409-6	PSB3KCC10
12	4.66 [118.36]	1437409-7	PSB3KCC12
14	5.41 [137.41]	1437409-8	PSB3KCC14
16	6.16 [156.46]	1437409-9	PSB3KCC16
18	6.91 [175.51]	1-1437409-0	PSB3KCC18
20	7.66 [194.56]	1-1437409-3	PSB3KCC20
22	8.41 [213.61]	3-1437406-5	PSB3KCC22
24	9.16 [232.66]	1-1437409-1	PSB3KCC24
26	9.91 [251.71]	1-1437409-2	PSB3KCC26
28	10.66 [270.76]	—	PSB3KCC28

*Circuit Identification Option
If marking is desired, select the Code Number listed for the appropriate configuration and add that number to the Catalog Number. Characters are 1/8" high.

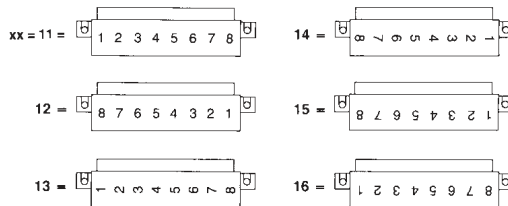

Note: All part numbers are RoHS Compliant.

Table of Contents—Interface Module Systems

Overview (Catalog Numbering Code)	196
Interface Modules	197-204
DIN 41612 Connector	198
Telco Connector	199
D-Sub Connector	200
Flat Cable Connector	201
DIP and ZIF Sockets	202
Card Edge Modules	203, 204
Sockets	
8 Pin Octal Socket Assemblies	205
11 Pin Socket Assemblies	206
16 Pin Miniature Socket Assemblies	207
14 Pin Miniature Socket Assemblies	208
11 Pin Square Socket Assemblies	209
Individual Sockets	210
SNAPTRACK Channel	211
Accessories	212

Note: All part numbers are RoHS Compliant.

Catalog Numbering Code

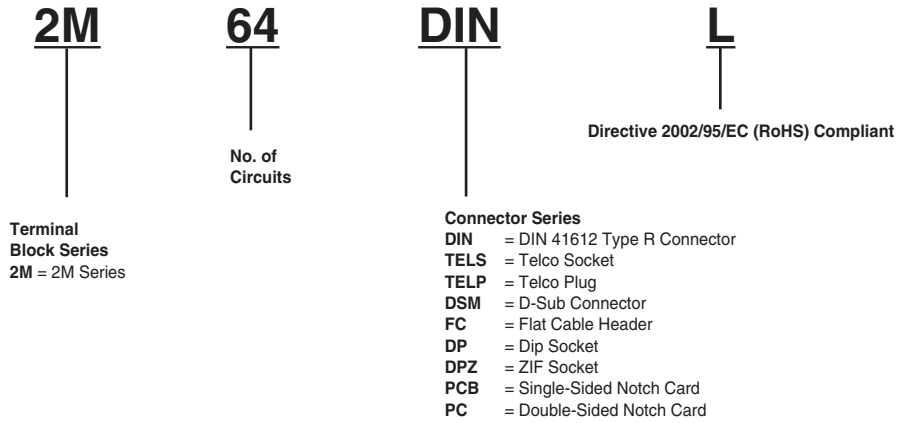

NOTE: Some catalog number combinations are not valid. Check appropriate catalog pages before ordering.

Interface Modules

Product Facts

- n Catalog designs for many industry connectors:
 - n DIN 41612 Connector
 - n Telco Connector
 - n D-Sub Connector
 - n Flat Cable Connector (daisy chain possible)
 - n DIP & ZIF Sockets
 - n Card Edge Modules
- n Mounts on SNAPTRACK Channel which can be panel mounted or snapped to a DIN rail.
- n Terminal Block screws supplied in ready-to-wire position to save installation time.

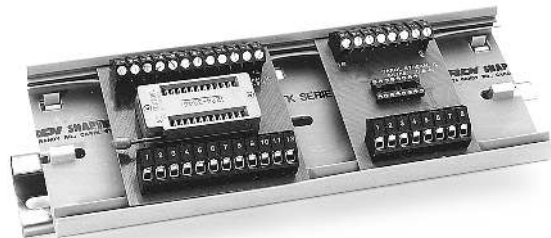

These Modules convert industry specific connectors to field wiring and are designed to supply custom solutions.

Note: All part numbers are RoHS Compliant.

DIN 41612 Connector



Material & Finish

Connector:

Housing Material—Thermoplastic polyester.

Flammability—UL94V-0

Terminals—Copper alloy, selective gold over nickel

Terminal Block:

Housing Material—Thermoplastic polyester

Flammability—UL94V-0

Color—Black

Max. Operating Temperature—120°C [248°]

Terminals—Bright acid-tin over copper alloy

Screws—#3-48, steel zinc plated

Wire Range—12-22 AWG

Mounting—2TK2 and 2TK2D Series SNAPTRACK Channel

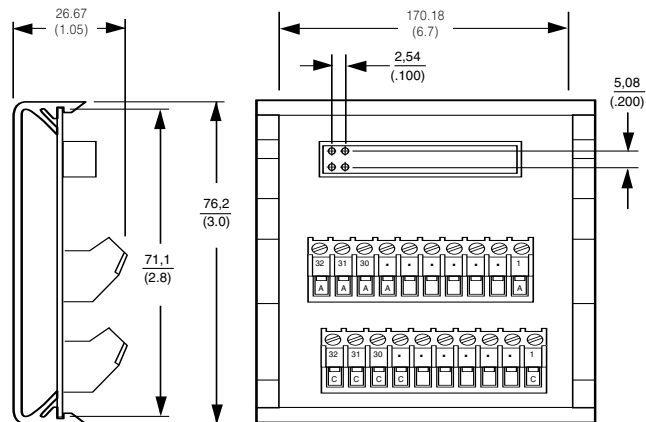

2M64DIN-C

2M64DIN

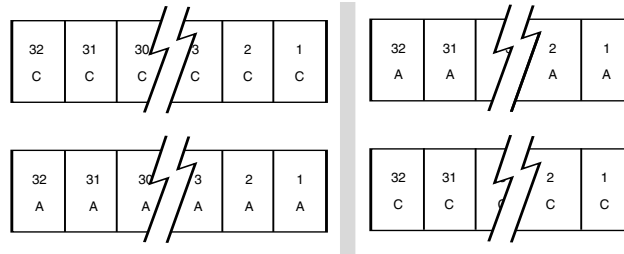

Description	DIN Connector Mates With	Non RoHS Compliant	
		Part Number	Catalog Number
64 Position reverse male DIN (Type R), A and C filled	Type Q	3-1437684-4	2M64DIN
64 Position male DIN (Type C), A and C filled	Type B	3-1437684-5	2M64DIN-C

Description	DIN Connector Mates With	RoHS Compliant	
		Part Number	Catalog Number
64 Position reverse male DIN (Type R), A and C filled	Type Q	1776645-1	2M64DINL
64 Position male DIN (Type C), A and C filled	Type B	1776646-1	2M64DIN-CL

Note: All part numbers are RoHS Compliant.

Telco Connector

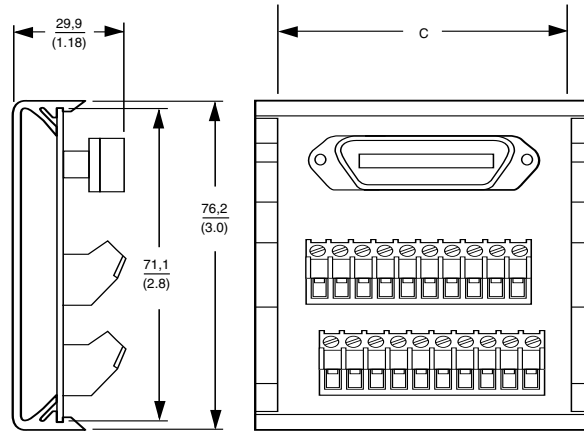

Material & Finish

Connector:

Housing Material—Thermoplastic polyester

Flammability—UL94V-0

Terminals—Copper alloy, selective gold over nickel

Application Data—2M50TELS(P)
Complies with SCSI Connections

Terminal Block:

Housing Material—Thermoplastic polyester

Flammability—UL94V-0

Color—Black

Max. Operating Temperature—120°C [248°]

Terminals—Bright acid-tin over copper alloy

Screws—#3-48, steel zinc plated

Wire Range—12-22 AWG

Mounting—2TK2 and 2TK2D Series SNAPTRACK Channel

No. of Positions	Dim. C	Non RoHS Compliant			
		Socket		Plug	
		Part Number	Catalog Number	Part Number	Catalog Number
36	4.30 (109.2)	2-1437684-1	2M36TELS	—	2M36TELP
50	5.70 (144.8)	3-1437684-2	2M50TELS	3-1437684-1	2M50TELP

No. of Positions	Dim. C	RoHS Compliant			
		Socket		Plug	
		Part Number	Catalog Number	Part Number	Catalog Number
36	4.30 (109.2)	1776826-1	2M36TELSL	—	2M36TELPL
50	5.70 (144.8)	1776604-1	2M50TELSL	1776643-1	2M50TELPL

D-Sub Connector

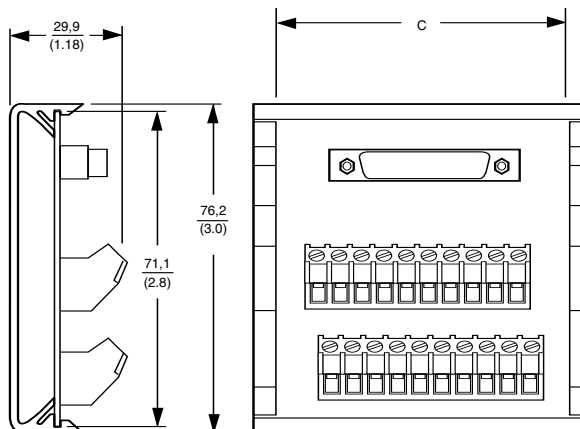

Material & Finish

Connector:

Housing Material—Thermoplastic polyester.

Flammability—UL94V-0

Terminals—Copper alloy, selective gold over nickel

Shell Material—Bright tin plated, female screw locks installed

Terminal Block:

Housing Material—Thermoplastic polyester

Flammability—UL94V-0

Color—Black

Max. Operating Temperature—120°C [248°]

Terminals—Bright acid-tin over copper alloy

Screws—#3-48, steel zinc plated

Wire Range—12-22 AWG

Mounting—2TK2 and 2TK2D Series SNAPTRACK Channel

No. of Positions	Dim. C	Non RoHS Compliant	
		Part Number	Catalog Number
09	1.50 (38.1)	1437684-3	2M09DSM
15	2.10 (53.3)	1437684-7	2M15DSM
25	3.10 (78.7)	1-1437684-8	2M25DSM
37	4.31 (109.5)	2-1437684-3	2M37DSM
50	5.93 (150.6)	2-1437684-9	2M50DSM

Note: Female D-Sub connector available as 2MxxDSF. Consult Technical Support Center.

No. of Positions	Dim. C	RoHS Compliant	
		Part Number	Catalog Number
09	1.50 (38.1)	1546693-1	2M09DSML
15	2.10 (53.3)	1546694-1	2M15DSML
25	3.10 (78.7)	1776224-1	2M25DSML
37	4.31 (109.5)	1776612-1	2M37DSML
50	5.93 (150.6)	1776613-1	2M50DSML

Note: Female D-Sub connector available as 2MxxDSFL. Consult Technical Support Center.

Note: All part numbers are RoHS Compliant.

Flat Cable Connector

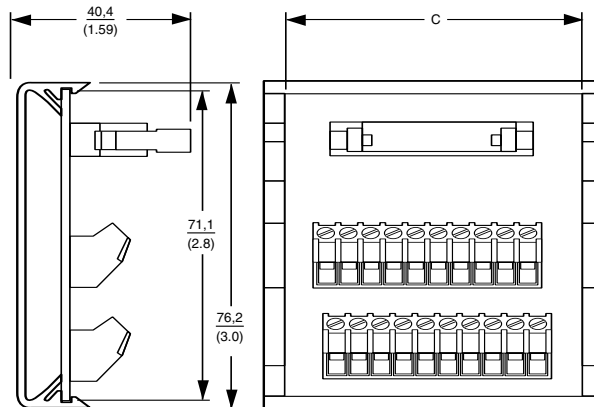
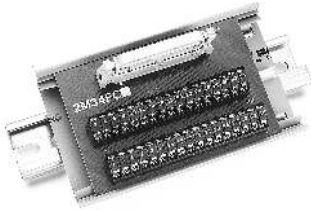

Material & Finish

Connector:

Header—Brass, gold over nickel, UL94V-0 thermoplastic

Connector—Copper alloy; gold over nickel 94V-0 thermoplastic

Wire Range—26-30 AWG solid, 28 AWG stranded

Maximum Current—1 Ampere

Terminal Block:

Housing Material—Thermoplastic polyester

Flammability—UL94V-0

Color—Black

Max. Operating Temperature—120°C [248°]

Terminals—Bright acid-tin over copper alloy

Screws—#3-48, steel zinc plated

Wire Range—12-22 AWG

Mounting—2TK2 and 2TK2D Series SNAPTRACK Channel

No. of Positions	Dim. C	Non RoHS Compliant		RoHS Compliant	
		Part Number	Catalog Number	Part Number	Catalog Number
10	38.1 (1.50)	1437684-5	2M10FC	1776615-1	2M10FCL
14	53.3 (2.10)	1437684-6	2M14FC	1776616-1	2M14FCL
16	58.4 (2.30)	1-1437684-1	2M16FC	1776625-1	2M15FCL
20	68.6 (2.70)	1-1437684-2	2M20FC	1776626-1	2M20FCL
26	81.3 (3.20)	1-1437684-9	2M26FC	1776630-1	2M26FCL
34	104.1 (4.10)	2-1437684-0	2M34FC	1776638-1	2M34FCL
40	119.4 (4.70)	2-1437684-6	2M40FC	1776640-1	2M40FCL
50	139.7 (5.50)	3-1437684-0	2M50FC	1776642-1	2M50FCL
60	165.1 (6.50)	3-1437684-3	2M60FC	1776644-1	2M60FCL
64	170.2 (6.70)	3-1437684-6	2M64FC	1776647-1	2M64FCL

Note: Strain relief connector supplied with all assemblies.

Note: All part numbers are RoHS Compliant.

DIP and ZIF Sockets

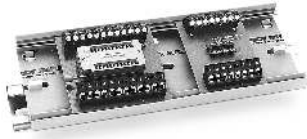

2M16DP

2M16DPZ

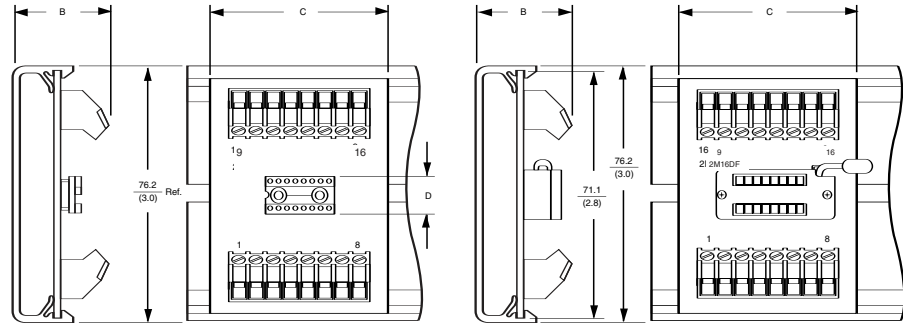

Material & Finish

Connector:

Terminal—Contacts copper alloy, gold over nickel

Terminal Block:

Housing Material—Thermoplastic polyester

Flammability—UL94V-0

Color—Black

Max. Operating Temperature—120°C [248°]

Terminals—Bright acid-tin over copper alloy

Screws—#3-48, steel zinc plated

Wire Range—12-22 AWG

Mounting—2TK2 and 2TK2D Series SNAPTRACK Channel

No. of Positions	Socket Pin Spacing Grid Size Dimensions			Non RoHS Compliant	
	B	C	D	Part Number	Catalog Number
DIP Socket to Screw Terminal					
8	1.05 (26.7)	1.20 (30.5)	.100 x .300 (2.5 x 7.6)	1437684-2	2M08DP
16	1.05 (26.7)	2.00 (50.8)	.100 x .300 (2.5 x 7.6)	1437684-8	2M16DP
24	1.05 (26.7)	2.80 (71.1)	.100 x .600 (2.5 x 15.2)	1-1437684-4	2M24DP
40	1.05 (26.7)	4.40 (111.8)	.100 x .600 (2.5 x 15.2)	2-1437684-4	2M40DP
ZIF Socket to Screw Terminal					
16	1.40 (35.6)	2.00 (50.8)	—	1-1437684-0	2M16DPZ
24	1.40 (35.6)	2.80 (71.1)	—	1-1437684-5	2M24DPZ
40	1.40 (35.6)	4.40 (111.8)	—	2-1437684-5	2M40DPZ

Note: ZIF denotes zero insertion force.

No. of Positions	Socket Pin Spacing Grid Size Dimensions			RoHS Compliant	
	B	C	D	Part Number	Catalog Number
DIP Socket to Screw Terminal					
8	1.05 (26.7)	1.20 (30.5)	.100 x .300 (2.5 x 7.6)	1776599-1	2M08DPL
16	1.05 (26.7)	2.00 (50.8)	.100 x .300 (2.5 x 7.6)	1776600-1	2M16DPL
24	1.05 (26.7)	2.80 (71.1)	.100 x .600 (2.5 x 15.2)	1776602-1	2M24DPL
40	1.05 (26.7)	4.40 (111.8)	.100 x .600 (2.5 x 15.2)	1776603-1	2M40DPL
ZIF Socket to Screw Terminal					
16	1.40 (35.6)	2.00 (50.8)	—	1776624-1	2M16DPZL
24	1.40 (35.6)	2.80 (71.1)	—	1776628-1	2M24DPZL
40	1.40 (35.6)	4.40 (111.8)	—	1776639-1	2M40DPZL

Note: ZIF denotes zero insertion force.

Card Edge Modules

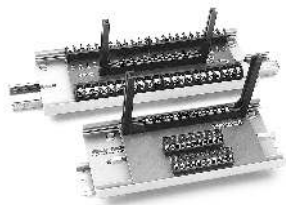

Material & Finish

Connector—Gold over nickel contact with card guide—accepts up to 4.5" [114.30] wide board. 0.156" [3.96] pitch (terminal spacing)

22PCB, 44PC

Terminal Block Tri-Barrier

Terminals—Bright acid tin over copper alloy

Screws—#4-40 steel zinc with clear chromate with captive wire clamping plate

Wire Range—14-22 AWG

Mounting—Fits TK2 & TK2D Series

2M22PCB, 2M44PC

Terminal Block:

Housing Material—Thermoplastic polyester

Flammability—UL94V-0

Color—Black

Max. Operating Temperature—120°C [248°]

Terminals—Bright acid-tin over copper alloy

Screws—#3-48, steel zinc plated

Wire Range—12-22 AWG

Mounting—2TK2 and 2TK2D Series SNAPTRACK Channel

Description	Non RoHS Compliant	
	Part Number	Catalog Number
For single-sided notched cards. Numbered Terminals 1-22 and A-Z	1437684-1	22PCB
For double-sided, notched cards. Numbered terminals A-Z, 1-22 and 1-44	3-1437684-7	44PC
Similar to 22PCB but all terminal positions are on one side of board	1-1437684-3	2M22PCB
Similar to 44PC but all terminal positions are on one side of board	2-1437684-7	2M44PC

Description	RoHS Compliant	
	Part Number	Catalog Number
For single-sided notched cards. Numbered Terminals 1-22 and A-Z	1776614-1	22PCBL
For double-sided, notched cards. Numbered terminals A-Z, 1-22 and 1-44	1776649-1	44PCL
Similar to 22PCBL but all terminal positions are on one side of board	1776627-1	2M22PCBL
Similar to 44PCL but all terminal positions are on one side of board	1776641-1	2M44PCL

Note: All part numbers are RoHS Compliant.

Card Edge Modules (Continued)

2M22PCB and 2M44PC

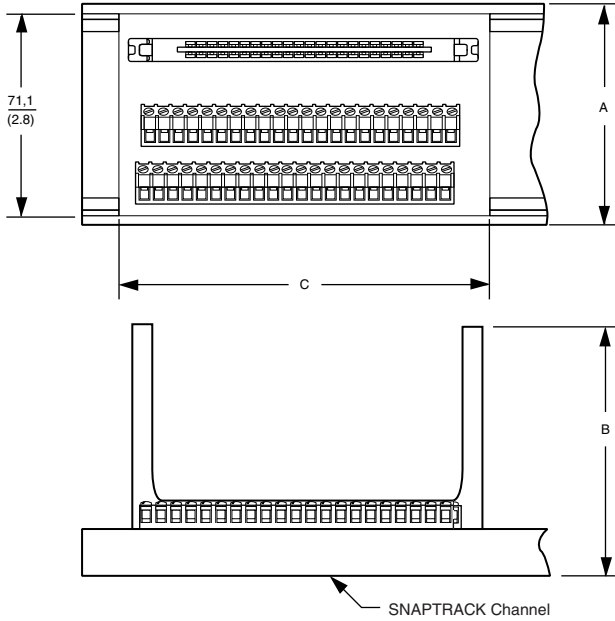

22PCB and 44PC

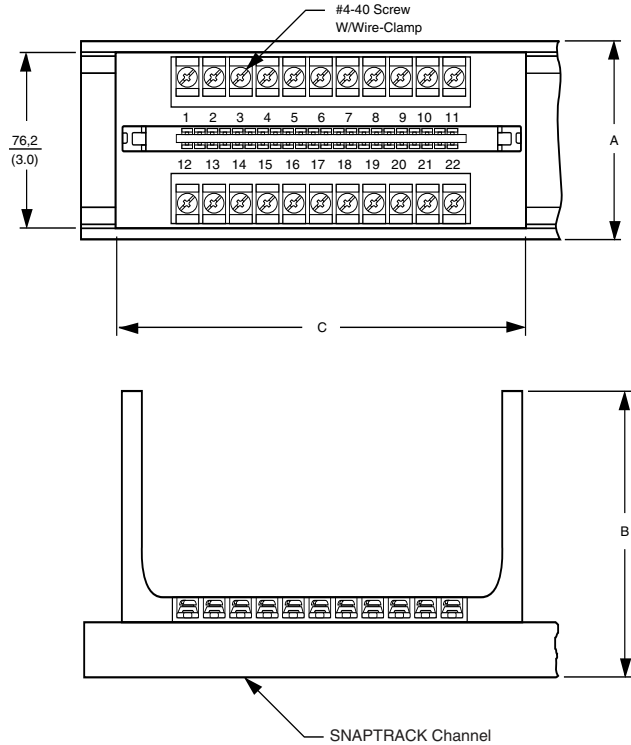

No. of Positions	Track Size	Dimensions				Non RoHS Compliant	
		A Ref.	B	C	PC Card Width	Part Number	Catalog Number
22	TK(2D)	80.3 (3.16)	90.4 (3.56)	127.0 (5.00)	114.3 (4.5)	1437684-1	22PCB
	2TK(2D)	69.9 (2.75)	90.4 (3.56)	127.0 (5.00)	114.3 (4.5)	1-1437684-3	2M22PCB
44	TK (2D)	80.3 (3.16)	90.4 (3.56)	190.5 (7.50)	114.3 (4.5)	3-1437684-7	44PC
	2TK(2D)	69.9 (2.75)	90.4 (3.56)	127.0 (5.00)	114.3 (4.5)	2-1437684-7	2M44PC

No. of Positions	Track Size	Dimensions				RoHS Compliant	
		A Ref.	B	C	PC Card Width	Part Number	Catalog Number
22	TK(2D)	80.3 (3.16)	90.4 (3.56)	127.0 (5.00)	114.3 (4.5)	1776614-1	22PCBL
	2TK(2D)	69.9 (2.75)	90.4 (3.56)	127.0 (5.00)	114.3 (4.5)	1776627-1	2M22PCBL
44	TK (2D)	80.3 (3.16)	90.4 (3.56)	190.5 (7.50)	114.3 (4.5)	1776649-1	44PCL
	2TK(2D)	69.9 (2.75)	90.4 (3.56)	127.0 (5.00)	114.3 (4.5)	1776641-1	2M44PCL

Note: All part numbers are RoHS Compliant.

8 Pin Octal Socket Assemblies

SM8 and 608BR

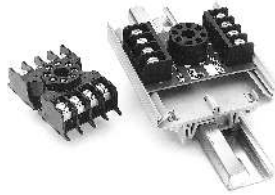

318BR, 208BR, 608BR, 218BR

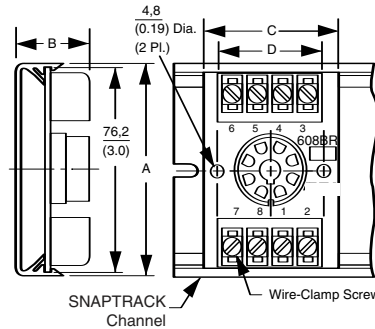

Material & Finish

208BR, 218BR, 318BR

Rating—10A, 150V

Screws—#4-40 zinc plated with clear chromate, with wire clamp

Wire Range—4-22 AWG

Bails—RB1, TB1(see accessory page 212)

608BR

Rating—10A, 250V

Screws—#6-32 zinc plated with wire clamp

Wire Range—12-22 AWG

Bails—RB1, TB1(see accessory page 212)

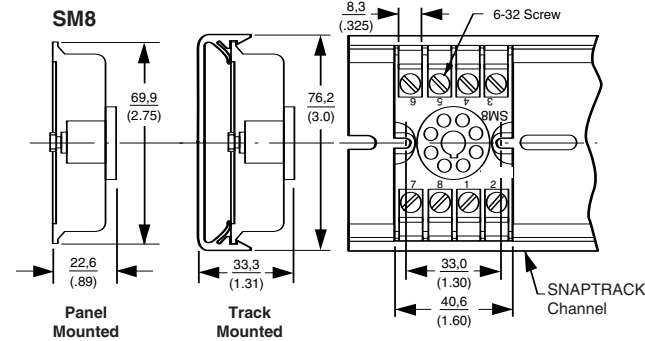

SM8

Rating—10A, 300V

Material—ABS

Flammability—UL94V-0

Contacts—Tin over copper-plated phosphor-bronze.

Screws—#6-32 zinc plated with clear chromate with wire clamping plates

Wire Range—12-22 AWG

Max. Operating Temperature—60°C [140°F]

Dimensions				Non RoHS Compliant		RoHS Compliant
A	B	C	D	Part Number	Catalog Number	SNAPTRACK® Channel
3.16 (80.3)	1.13 (28.7)	2.00 (50.8)	1.69 (42.9)	1437683-6	208BR	TK2(D)
3.16 (80.3)	1.13 (28.7)	1.50 (38.1)	—	1-1437683-0	218BR	TK2(D)
2.90 (73.7)	1.13 (28.7)	1.50 (38.1)	—	1-1437683-4	318BR	2TK2(D)
3.16 (80.3)	1.13 (28.7)	2.00 (50.8)	1.69 (42.9)	1-1437683-6	608BR	TK2(D)
—	—	—	—	2-1437683-8	SM8	2TK2

Note: SM8 is a molded product with mounting holes provided.

Related Product Data

Sockets on this page will fit the following relays:

Tyco Electronics Relay Series—

SCB, SCC, SCE, SRC, SSC, SST, VMA

P&B Relay Series—CB, CD, CG, CH,

CK, CR, CN1, CNS, CS, KRP/KRPA,

S89R_P, 155

SCHRACK Relay Series—MT

For more information on Relays request Catalog 1308242.

Dimensions				RoHS Compliant		
A	B	C	D	Part Number	Catalog Number	SNAPTRACK® Channel
3.16 (80.3)	1.13 (28.7)	2.00 (50.8)	1.69 (42.9)	1776633-1	208BRL	TK2(D)
3.16 (80.3)	1.13 (28.7)	1.50 (38.1)	—	1776617-1	218BRL	TK2(D)
2.90 (73.7)	1.13 (28.7)	1.50 (38.1)	—	1776619-1	318BRL	2TK2(D)
3.16 (80.3)	1.13 (28.7)	2.00 (50.8)	1.69 (42.9)	1776620-1	608BRL	TK2(D)
—	—	—	—	2-1437683-8	SM8	2TK2

Note: SM8 is a molded product with mounting holes provided.

Note: All part numbers are RoHS Compliant.

11 Pin Socket Assemblies

SM11 and 611BR

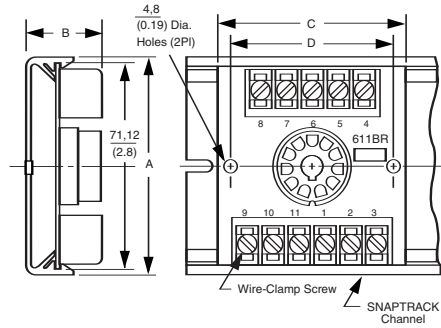
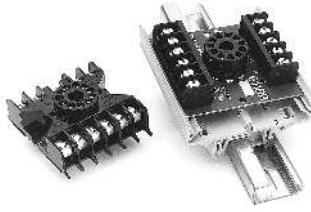

Material & Finish

211BR, 311BR

Rating—10A, 150V
Screws—#4-40 zinc plated with clear chromate with wire clamps
Wire Range—14-22 AWG
Bails—RB1, TB1 (see accessory page 212)

611BR

Rating—10A, 250V
Screws—#6-32 zinc plated with clear chromate, with wire clamps.
Wire Range—12-22 AWG
Bails—RB1, TB1 (see accessory page 212)

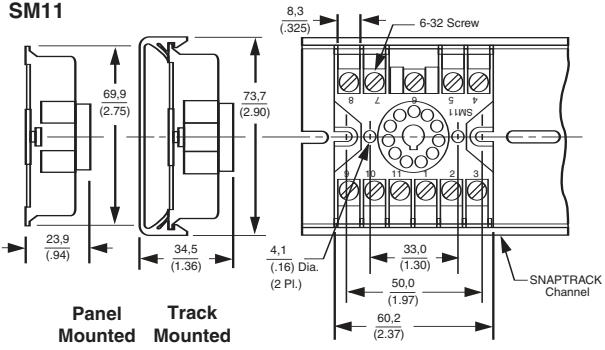

SM11

Rating—10A, 300V
Material—ABS
Flammability—UL94V-0
Max. Operating Temperature—60°C [140°F]
Contacts—Tin over copper-plated phosphor-bronze.
Screws—#6-32 zinc plated with clear chromate, with wire clamps
Wire Range—12-22 AWG
Bails—RB5 (see accessory page 212)

Dimensions				Non RoHS Compliant		RoHS Compliant
A	B	C	D	Part Number	Catalog Number	SNAPTRACK® Channel
3.16 (80.3)	1.13 (28.7)	2.13 (54.1)	1.18 (46.0)	1437683-7	211BR	TK2(D)
2.90 (73.7)	1.13 (28.7)	2.13 (54.1)	1.18 (46.0)	1-1437683-2	311BR	2TK2(D)
3.16 (80.3)	1.13 (28.7)	2.75 (69.9)	2.30 (60.5)	1-1437683-8	611BR	TK2(D)
—	—	—	—	2-1437683-7	SM11	2TK

Note: SM11 is a molded product with mounting holes provided.

Related Product Data

Sockets on this page will fit the following relays:

- Tyco Electronics Relay Series**—SCF, SSC, SCB, SCC, SST
- P&B Relay Series**—CB, CD, CG, CH, CK, CNM5, CNS, CNT, KBP, KRP/KRPA, 155
- SCHRACK Relay Series**—MT

For more information on Relays request Catalog 1308242.

Dimensions				RoHS Compliant		
A	B	C	D	Part Number	Catalog Number	SNAPTRACK® Channel
3.16 (80.3)	1.13 (28.7)	2.13 (54.1)	1.18 (46.0)	1776634-1	211BRL	TK2(D)
2.90 (73.7)	1.13 (28.7)	2.13 (54.1)	1.18 (46.0)	1776827-1	311BRL	2TK2(D)
3.16 (80.3)	1.13 (28.7)	2.75 (69.9)	2.30 (60.5)	1776622-1	611BRL	TK2(D)
—	—	—	—	2-1437683-7	SM11	2TK

Note: SM11 is a molded product with mounting holes provided.



Note: All part numbers are RoHS Compliant.

16 Pin Miniature Socket Assemblies

204BS



Material & Finish

Rating—5A,150V

Max. Operating Temperature—105°C

Screws—#4-40 zinc plated with captive wire clamping plate

Wire Range—14-22 AWG

Bails—204BS-RB4 (see accessory page 212)

Related Product Data

Sockets on this page will fit the following relays:

P&B Relay Series—R10

For more information on Relays request Catalog 1308242.

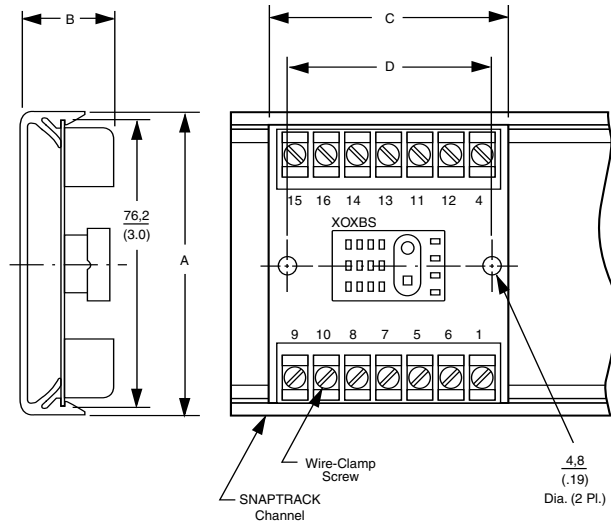

Dimensions				Fits Relay	Non RoHS Compliant		RoHS Compliant
A	B	C	D		Part Number	Catalog Number	SNAPTRACK® Channel
3.16 (80.3)	1.00 (25.4)	1.50 (38.1)	—	2PDT	1437683-4	202BS	TK2(D)
3.16 (80.3)	1.00 (25.4)	2.50 (63.5)	2.13 (54.1)	4PDT	1437683-5	204BS	TK2

Note: Holes provided for bails, see page 212.

Dimensions				Fits Relay	RoHS Compliant		
A	B	C	D		Part Number	Catalog Number	SNAPTRACK® Channel
3.16 (80.3)	1.00 (25.4)	1.50 (38.1)	—	2PDT	1776631-1	202BSL	TK2(D)
3.16 (80.3)	1.00 (25.4)	2.50 (63.5)	2.13 (54.1)	4PDT	1776632-1	204BSL	TK2

Note: Holes provided for bails, see page 212.

Note: All part numbers are RoHS Compliant.

14 Pin Miniature Socket Assemblies

214BS

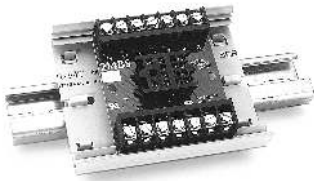

Material & Finish

Ratings—5A,150V

214BS, 314BS

Screws—#4-40 zinc plated with clear chromate, with captive wire clamping plate

Wire Range—14-22 AWG

614BS

Screws—#6-32 zinc plated with clear chromate, with wire clamp

Wire Range—12-22 AWG

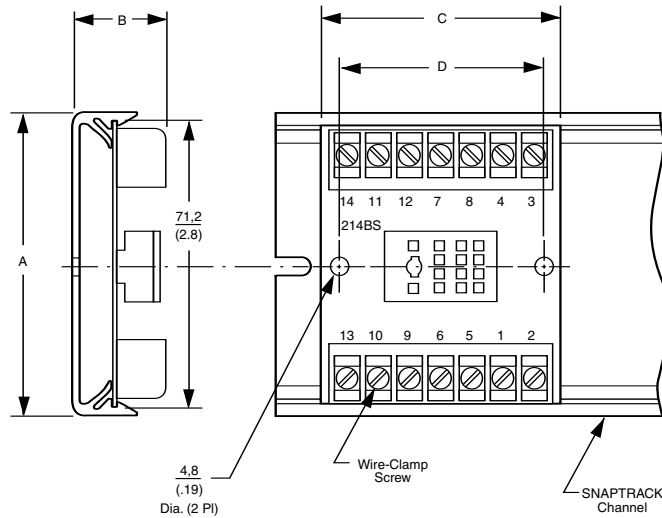

Related Product Data

Sockets on this page will fit the following relays:

P&B Relay Series—KHAU/KHU, 156, 158

SCHRACK Relay Series—PT

For more information on Relays request Catalog 1308242.

Dimensions				Fits Relay	Non RoHS Compliant		RoHS Compliant
A	B	C	D		Part Number	Catalog Number	SNAPTRACK® Channel
3.16 (80.3)	1.06 (26.9)	2.50 (63.5)	2.13 (54.0)	4PDT	1437683-9	214BS	TK2(D)
2.90 (73.7)	1.06 (26.9)	2.50 (63.5)	—	4PDT	1-1437683-3	314BS	2TK2(D)
3.16 (80.3)	1.13 (28.7)	2.75 (69.9)	—	4PDT	2-1437683-0	614BS	TK2(D)

Note: Holes provided for bails, see page 212.

Dimensions				Fits Relay	RoHS Compliant		
A	B	C	D		Part Number	Catalog Number	SNAPTRACK® Channel
3.16 (80.3)	1.06 (26.9)	2.50 (63.5)	2.13 (54.0)	4PDT	1776636-1	214BSL	TK2(D)
2.90 (73.7)	1.06 (26.9)	2.50 (63.5)	—	4PDT	1776618-1	314BSL	2TK2(D)
3.16 (80.3)	1.13 (28.7)	2.75 (69.9)	—	4PDT	1776637-1	614BSL	TK2(D)

Note: Holes provided for bails, see page 212.



Note: All part numbers are RoHS Compliant.

11 Pin Square Socket Assemblies

608BS

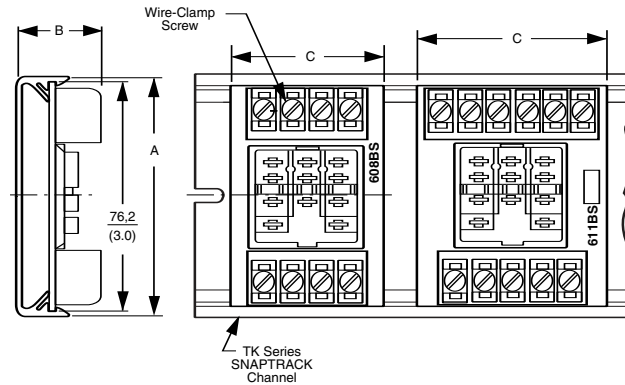
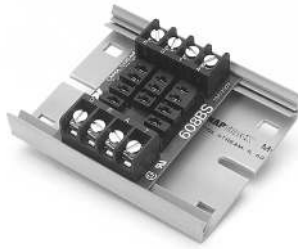

Material & Finish

608BS, 611BS

Rating—10A, 250V

Screws—#6-32 zinc plated with clear chromate, with wire clamp

Wire Range—12-22 AWG

211BS

Rating—10A, 150V

Screws—#4-40 zinc plated with clear chromate, with wire clamp

Wire Range—14-22 AWG

Related Product Data

Sockets on this page will fit the following relays:

Tyco Electronics Relay Series—STA

P&B Relay Series—CL, CU, KUPE, KUIP, KUMP, KUGP, KUL, KUP, SDAS-01, 157

SCHRACK Relay Series—RM2/3/7, RM5/6

For more information on Relays request Catalog 1308242.

Dimensions			Fits Relay	Non RoHS Compliant		RoHS Compliant
A	B	C		Part Number	Catalog Number	SNAPTRACK® Channel
3.16 (80.3)	1.06 (26.9)	2.13 (54.1)	SPDT, DPDT	1437683-8	211BS	TK2(D)
3.16 (80.3)	1.13 (28.7)	2.00 (50.8)	3PDT	1-1437683-7	608BS	TK2(D)
3.16 (80.3)	1.13 (28.7)	2.50 (63.5)	DPDT, 3PDT	1-1437683-9	611BS	TK2(D)

Dimensions			Fits Relay	RoHS Compliant		
A	B	C		Part Number	Catalog Number	SNAPTRACK® Channel
3.16 (80.3)	1.06 (26.9)	2.13 (54.1)	SPDT, DPDT	1776630-1	211BSL	TK2(D)
3.16 (80.3)	1.13 (28.7)	2.00 (50.8)	3PDT	1776621-1	608BSL	TK2(D)
3.16 (80.3)	1.13 (28.7)	2.50 (63.5)	DPDT, 3PDT	1776623-1	611BSL	TK2(D)

211BS ONLY



LR49571



E58648

Note: All part numbers are RoHS Compliant.

Individual Sockets

Material & Finish

- Ratings**—10A/300V
- Housing Material**—Thermoplastic polyester
- Flammability**—UL94V-0
- Color**—Black
- Max. Operating Temperature**—130°C [266°F]
- Contacts**—Phosphor-bronze, bright acid-tin plated

Related Product Data

Sockets 8S and 11S will fit the following relays:

- AGASTAT Relay Series**—STA
 - P&B/MIDTEX Relay Series**—CL, CU, KUJEP, KUIP, KUMP, KUGP, KUL, KUP, SDAS-01, 157
 - SCHRACK Relay Series**—RM2/3/7, RM5/6
- Socket 21S will fit the following relays:
- P&B Relay Series**—R10
- Socket 14S will fit the following relays:
- P&B/MIDTEX Relay Series**—KHAU/KHU, 156, 158
 - SCHRACK Relay Series**—PT

- Socket 8R will fit the following relays:
- AGASTAT Relay Series**—SCB, SCC, SCE, SRC, SSC, SST, VMA
 - P&B/MIDTEX Relay Series**—CB, CD, CG, CH, CK, CR, CN1, CNS, CS, KRP/KRPA, S89R__P, 155

- SCHRACK Relay Series**—MT
- Socket 11R will fit the following relays:
- Tyco Electronics Relay Series**—SCF, SSC, SCB, SCC, SST
 - P&B Relay Series**—CB, CD, CG, CH, CK, CNM5, CNS, CNT, KBP, KRP/KRPA, 155

SCHRACK Relay Series—MT
For more information on Relays request Catalog 1308242.



11R, 8R

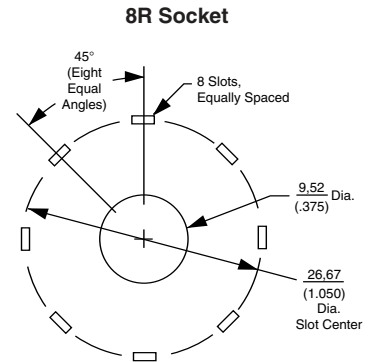

8R Socket

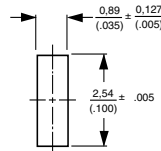



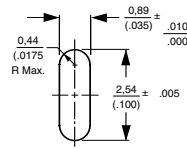

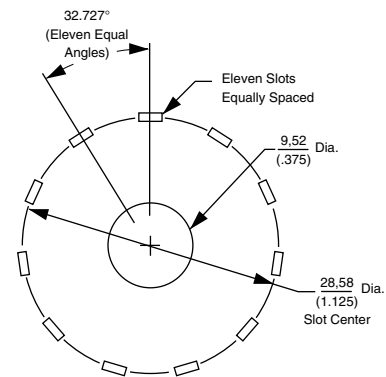

Punched Slot Detail



Routed Slot Detail



11R Socket

Socket Style	Fits Relays	Part Number	Catalog Number
	2PDT	2-1437683-2	8S-SOCKET
	3PDT	1437661-1	11S-SOCKET
	2PDT	1-1437683-1	21S-SOCKET
	4PDT	1437683-3	14S-SOCKET
	8 pin octal	2-1437683-1	8R-SOCKET
	11 pin	1437683-1	11R-SOCKET



E58648

Note: All part numbers are RoHS Compliant.

SNAPTRACK Channel

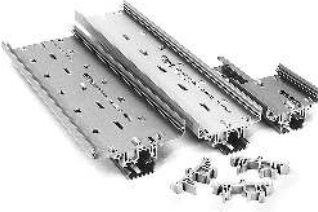

SNAPTRACK Channel can be mounted on standard DIN rails or A Series rail when used with TKAD. (Rails not included.)

SNAPTRACK Channel is a nonconductive, rigid extruded PVC chassis used for mounting socket assemblies and custom circuit boards. Available in a variety of fixed widths, including a split-apart version for wider PCB applications, SNAPTRACK Channel mounts to panels quickly with rivets or screws.

Printed circuit boards are simply snapped-in from the front, then held securely via intergral ribs which also serve as shock absorbers when the PCB is flexed. SNAPTRACK Channel permits easy, convenient PCB removal for field service. Slots on 2-inch centers are provided for fast, easy installation using either plastic rivets or other hardware. Double-faced tape may also be used effectively.

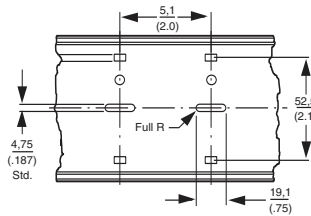

TK2D, 2TK2D, 3TK2D, 6TK2D Panel Mount, or use with TKAD to Mount on DIN Rail and A Series Rail

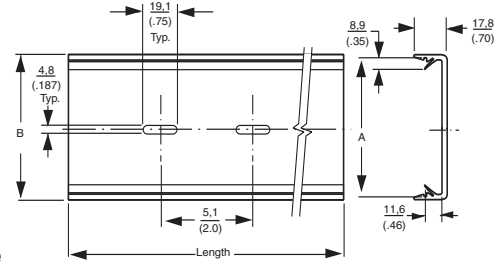

TK2, 3TK2, 8TK2, 2TK2, 6TK2 Panel Mount

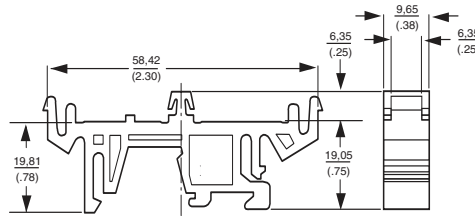

TKAD use with SNAPTRACK Channel to Mount on DIN Rail or A Series Rail

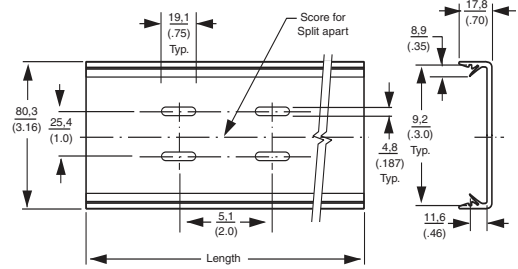

4TK2 Panel Mount

Track Catalog No.*	Dimensions	
	A P.C. Board Width	B Overall Track Width
8TK2-xx	55.5 (2.187)	58.4 (2.3)
2TK2-xx	69.9 (2.75)	73.7 (2.9)
2TK2D-xx	69.9 (2.75)	73.7 (2.9)
TK2-xx-AG	76.2 (3.0)	78.7 (3.1)
TK2D-xx-AG	76.2 (3.0)	78.7 (3.1)
3TK2-xx	82.6 (3.25)	86.4 (3.40)
3TK2D-xx	82.6 (3.25)	86.4 (3.40)
6TK2-xx	101.6 (4.0)	105.4 (4.15)
6TK2D-xx	101.6 (4.0)	105.4 (4.15)
4TK2-xx	SPLIT-APART	—

Note: Standard lengths are 3", 6", 12", 24", and 48". Custom lengths are available.

*Replace xx with track length.

Accessories

Track Rivets

Plastic Track Rivet offers a low cost way to mount SNAPTRACK Channel. Requires 3/16" diameter hole in panels up to .125" thick. Cat. No. TR-1



TR-1 Track Rivet
1437645-6

Bails (Tie Downs)

Helps prevent relays and timers from vibrating out of sockets. RB1-AG and TB1, for general purpose relays and timers, feature adjustable height; mount on PC board with plastic mounting rivets (2) furnished. New economy RB5 spring bails fits most general purpose relays and timers. RB4 clip to miniature sockets. Stainless steel wire.

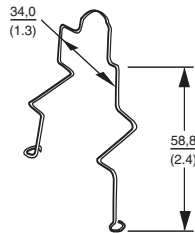

RB1-AG Relay Bail
2-1437683-3

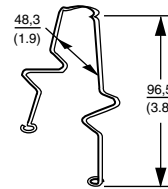

TB1 Timer Bail
3-1437683-0

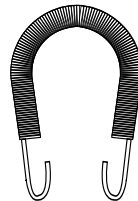

RB5-AG Universal Bail
2-1437683-6

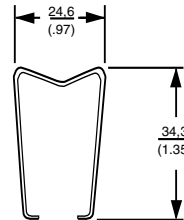

RB4-AG
2-1437683-5

Note: All part numbers are RoHS Compliant.

Table of Contents—Europa

Overview (Selector Chart)	214, 215
(Catalog Numbering Code)	216
(Introduction)	217
Europa—Tubular Screw Barrier Strips	218-233
8mm [.315] Pitch, 30A, Series TSB230	218-220
10mm [.394] Pitch, 30A, Series TSB500	221-224
10mm [.394] Pitch, Fused Blocks, Series 503Si	225
12mm [.472] Pitch, 40-50A, Series TSB1000	226
12mm [.472] Pitch, Fused Blocks, Series 1003Si	229
13.5mm [.531] Pitch, 40A, Series TSB1500	230
14.5mm [.571] Pitch, 65A, Series TSB2000	231-233
Accessories	234-237

Europa Selector Chart

Panel Mounted Modular Blocks



Series	TSB230	TSB230...HT	TSB500	TSB500...HT	TSB500SK	500Si	503Si
Pitch (mm) (in.)	8mm .315"	8mm .315"	10mm .394"	10mm .394"	10mm .394"	10, 12mm .394", .472"	10mm .394"
Circuits	1-12	1-12	1-12	1-12	1-12	1	1-5
Max. Current							
Wire protector	30A	30A	30A	30A	30A	—	10A
Tunnel connection	30A	—	40A	—	30A	10A	10A
Max. Voltage	250V	250V	250V	250V	600V	250V	250V
Wire Range (AWG)							
Wire protector	12-26	12-26	10-24	12-24	12-24	—	12-22
Tunnel connection	12-24	—	10-22	—	10-22	12-22	12-22
Flammability	UL94V-2	UL94V-0	UL94V-2	UL94V-0	UL94V-2	UL94V-2	UL94V-2
Max. Temp.	100° C	150° C	100° C	150° C	100° C	100° C	100° C
Page	218, 219	220	221	223	224	234	225

Note: All part numbers are RoHS Compliant.

Europa Selector Chart (Continued)

Panel Mounted Modular Blocks

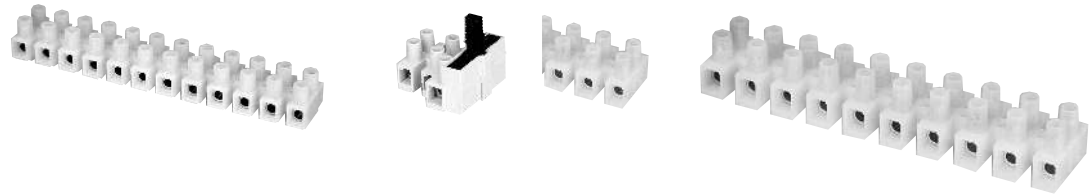

Series	TSB1000	TSB1000...HT	1003Si	TSB1500	TSB2000	TSB2000...HT	TSB2000...US
Pitch (mm) (in.)	12mm .472"	12mm .472"	7/12mm .275-.472"	13.5mm .532"	14.5mm .571"	14.5mm .571"	14.5mm .571"
Circuits	1-12	1-12	1-5	1-12	1-12	1-12	1-12
Max. Current							
Wire protector	40A	40A	16A	40A	65A	65A	65A
Tunnel connection	40A	—	16A	40A	65A	65A	65A
Max. Voltage	250V	250V	250V	300V	300V	300V	600V
Wire Range (AWG)							
Wire protector	10-22	10-24	10-24	8-18	6-14	6-14	6-14
Tunnel connection	8-22	—	8-22	8-16	6-14	6-14	6-14
Flammability	UL94V-2	UL94V-0	UL94V-2	UL94V-2	UL94V-2	UL94V-0	UL94V-2
Max. Temp.	100° C	150° C	100° C	100° C	100° C	150° C	100° C
Page	226, 227	228	229	230	231	232	233

Europa Terminal Blocks **5**

Catalog Numbering Code

Europa Blocks

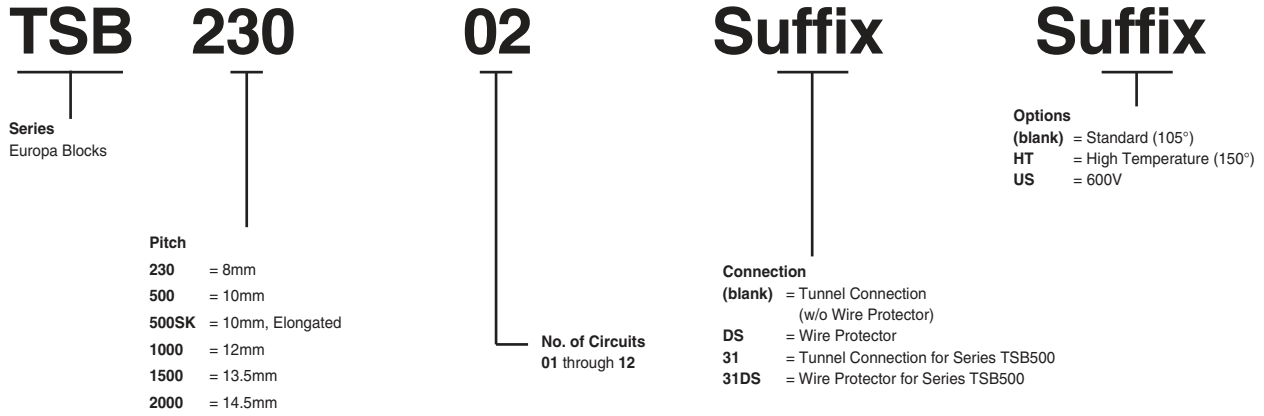

Fused Europa Blocks

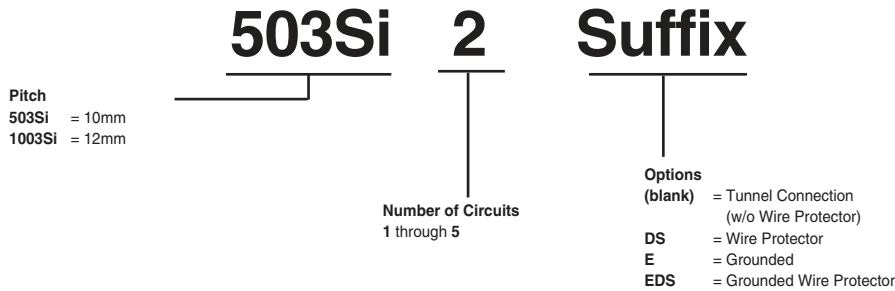

Note: Some catalog number combinations are not valid. Check appropriate catalog pages before ordering.

Europa Blocks

Product Facts

- n **Modular design** — cut into smaller sections without altering electrical properties or order product molded to length. Mounting holes between every circuit.
- n **Tubular contacts** — connect stripped, unterminated solid or stranded wire directly to each contact — no wire lugs needed.
- n **High voltage and current ratings** — rated up to 600 volts and up to 65 amps depending on model and wire size used.
- n **Broad Wire Range** — use wire from #6 to #26 AWG depending on model selected.
- n **Wire protectors** — all models available with wire protectors to virtually eliminate twisting and breakage of stranded wire during connection.
- n **High circuit density** — five models provide from 21 to 38 circuits per foot.
- n **“Dead-front” construction** — both screws and tubular contacts are recessed in housing for safety and to help prevent short circuits.
- n **Captive screws** — zinc with chromate plated steel screws are captive in tin plated brass contacts. They are supplied “backed-out” and ready to wire.
- n **Flammability rating of UL94V-2 is standard. High Temperature versions with UL94V-0 are available.**
- n **Wire stop available on some versions.**

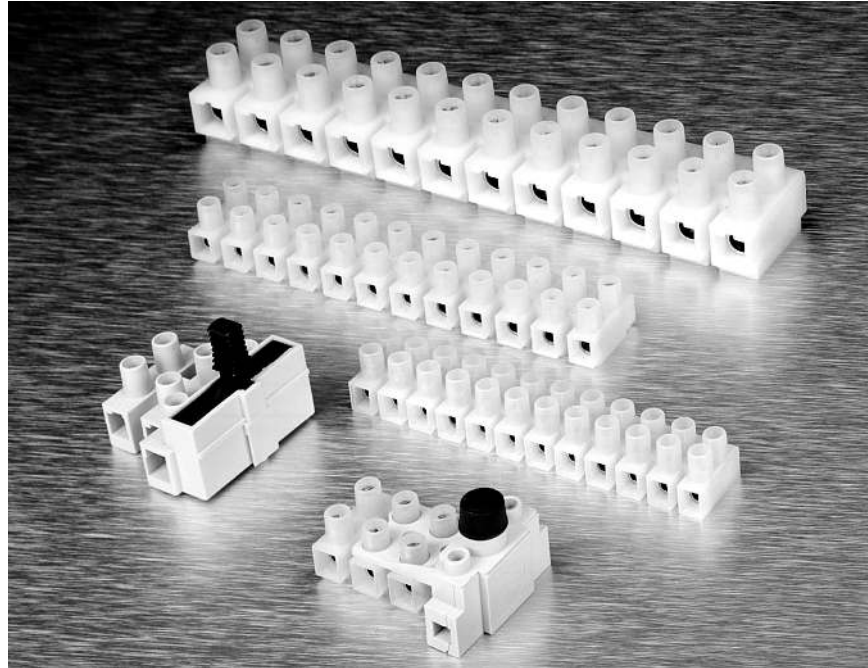

Tyco Electronics Corporation offers the most extensive line of Europa products in five pitches:

- n 8mm [.315]
- n 10mm [.394]
- n 12mm [.472]
- n 13.5mm [.531]
- n 14.5mm [.571]

Two connection styles are available. The Wire Protector version supplies a plate to shield the wire from being cut by the screw. The Tunnel connection is the same design, but without the shielding plate – it is ideal for solid wire or where the most economical price is required.

Applications include:

- n Motor Controls
- n Power Supplies
- n Telecom
- n Valve Actuators
- n Spa Controllers
- n Lighting

Note: All part numbers are RoHS Compliant.

8mm [.315] Pitch, 30A with Wire Protector—Series TSB230

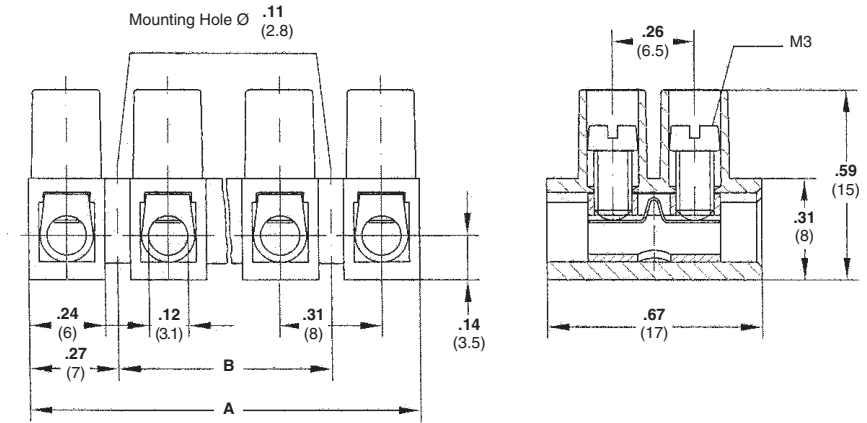

Material & Finish

- Housing Material**—Polyamide 6
- Flammability**—UL94V-2
- Color**—natural (off white)
- Tubular Contact**—Brass, tin plated
- Screw**—Steel, M3
- Screw Plating**—Zinc with chromate
- Wire Protector**—Stainless steel

Mechanical Properties

- Pitch (terminal spacing)**—8mm [.315"]
- Wire Strip Length**—5mm [0.20"]
- Min. Wire Pull-Out Force**—75lbs.
- Recommended Tightening Torque**—5in.- lbs.
- Recommended Screwdrivers**—Stanley 1016, Sears Craftsman 41429, Xcelite R184

Electrical Properties

- Maximum Current**—30A
- Operating Voltage**—250V
- Wire Range**—12-26 AWG
- Dielectric Withstand**—3000V

Environmental Properties

- Continuous Working Temperature**—-35°C to +100°C [-31°F to +212°F]

No. of Positions	Dimensions		Wire Protector	
	A	B	Part Number	Catalog Number
1	6 (.24)	—	1776293-1	TSB230 01DS
2	14 (.55)	—	1776293-2	TSB230 02DS
3	22 (.87)	8 (.31)	1776293-3	TSB230 03DS
4	30 (1.18)	16 (.63)	1776293-4	TSB230 04DS
5	38 (1.50)	24 (.94)	1776293-5	TSB230 05DS
6	46 (1.81)	32 (1.26)	1776293-6	TSB230 06DS
7	54 (2.13)	40 (1.57)	1776293-7	TSB230 07DS
8	62 (2.44)	48 (1.89)	1776293-8	TSB230 08DS
9	70 (2.76)	56 (2.20)	1776293-9	TSB230 09DS
10	78 (3.07)	64 (2.52)	1-1776293-0	TSB230 10DS
11	86 (3.39)	72 (2.83)	1-1776293-1	TSB230 11DS
12	94 (3.70)	80 (3.15)	1-1776293-2	TSB230 12DS

Note: All part numbers are RoHS Compliant.

8mm [.315] Pitch, 30A, with Tunnel Connection—Series TSB230

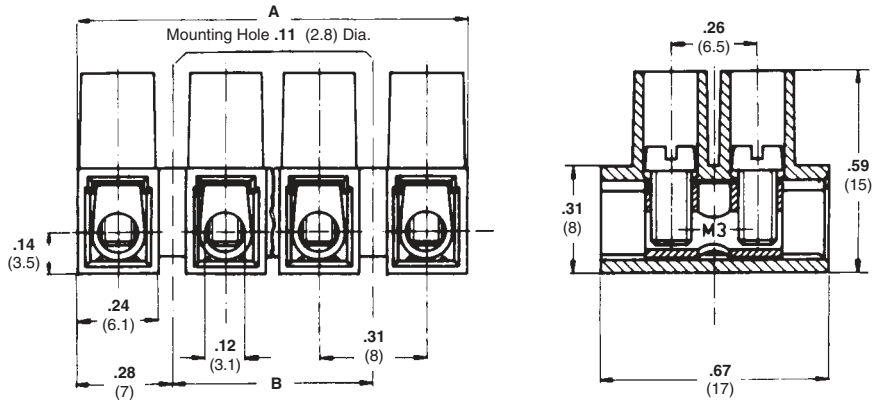

Material & Finish

- Housing Material**—Polyamide 6
- Flammability**—UL94V-2
- Color**—natural (off white)
- Tubular Contact**—Brass, tin plated
- Screw**—Steel, M3
- Screw Plating**—Zinc with chromate

Mechanical Properties

- Pitch (terminal spacing)**—8mm [.315]
- Wire Strip Length**—5mm [0.20"]
- Min. Wire Pull-Out Force**—75lbs.

Recommended Tightening Torque—5in.-lbs.

Recommended Screwdrivers—Stanley 1016, Sears Craftsman 41429, Xcelite R184

Electrical Properties

- Maximum Current**—30A
- Operating Voltage**—250V
- Wire Range**—12-24 AWG
- Dielectric Withstand**—3000V

Environmental Properties

Continuous Working Temperature—-35°C to +100°C [-31°F to +212°F]

No. of Positions	Dimensions		Tunnel Connection	
	A	B	Part Number	Catalog Number
1	6 (.24)	—	1776294-1	TSB230 01
2	14 (.55)	—	1776294-2	TSB230 02
3	22 (.87)	8 (.31)	1776294-3	TSB230 03
4	30 (1.18)	16 (.63)	1776294-4	TSB230 04
5	38 (1.50)	24 (.94)	1776294-5	TSB230 05
6	46 (1.81)	32 (1.26)	1776294-6	TSB230 06
7	54 (2.13)	40 (1.57)	1776294-7	TSB230 07
8	62 (2.44)	48 (1.89)	1776294-8	TSB230 08
9	70 (2.76)	56 (2.20)	1776294-9	TSB230 09
10	78 (3.07)	64 (2.52)	1-1776294-0	TSB230 10
11	86 (3.39)	72 (2.83)	1-1776294-1	TSB230 11
12	94 (3.70)	80 (3.15)	1-1776294-2	TSB230 12

Europa Terminal Blocks
5



8mm [.315] Pitch, 30A, High Temperature—Series TSB230...HT

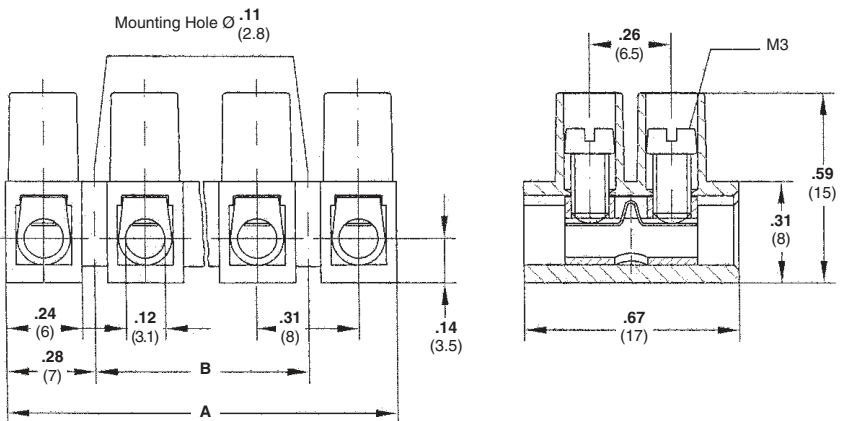

Material & Finish

- Housing Material**—Polyamide 6/6
- Flammability**—UL94V-0
- Housing Color**—Brown
- Tubular Contact**—Brass, tin plated
- Screw**—Steel, M3
- Screw Plating**—Zinc with chromate
- Wire Protector**—Stainless steel

Mechanical Properties

- Pitch (terminal spacing)**—8mm [.315]
- Wire Strip Length**—5mm [0.20"]
- Min. Wire Pull-Out Force**—75lbs.
- Recommended Tightening Torque**—5in.-lbs.
- Recommended Screwdrivers**—Stanley 1016, Sears Craftsman 41429, Xcelite R184
- Electrical Properties**
- Maximum Current**—30A
- Operating Voltage**—250V
- Wire Range**—12-26 AWG
- Dielectric Withstand**—3000V

Environmental Properties

- Continuous Working Temperature**—-35°C to +150°C [-31°F to +302°F]

No. of Positions	Dimensions		Wire Protector	
	A	B	Part Number	Catalog Number
1	6 (.24)	—	1776295-1	TSB230 01DS HT
2	14 (.55)	—	1776295-2	TSB230 02DS HT
3	22 (.87)	8 (.31)	1776295-3	TSB230 03DS HT
4	30 (1.18)	16 (.63)	1776295-4	TSB230 04DS HT
5	38 (1.50)	24 (.94)	1776295-5	TSB230 05DS HT
6	46 (1.81)	32 (1.26)	1776295-6	TSB230 06DS HT
7	54 (2.13)	40 (1.57)	1776295-7	TSB230 07DS HT
8	62 (2.44)	48 (1.89)	1776295-8	TSB230 08DS HT
9	70 (2.76)	56 (2.20)	1776295-9	TSB230 09DS HT
10	78 (3.07)	64 (2.52)	1-1776295-0	TSB230 10DS HT
11	86 (3.39)	72 (2.83)	1-1776295-1	TSB230 11DS HT
12	94 (3.70)	80 (3.15)	1-1776295-2	TSB230 12DS HT

Note: Minimum order quantities may apply.

Note: All part numbers are RoHS Compliant.

10mm [.394] Pitch, 30A with Wire Protector—Series TSB500

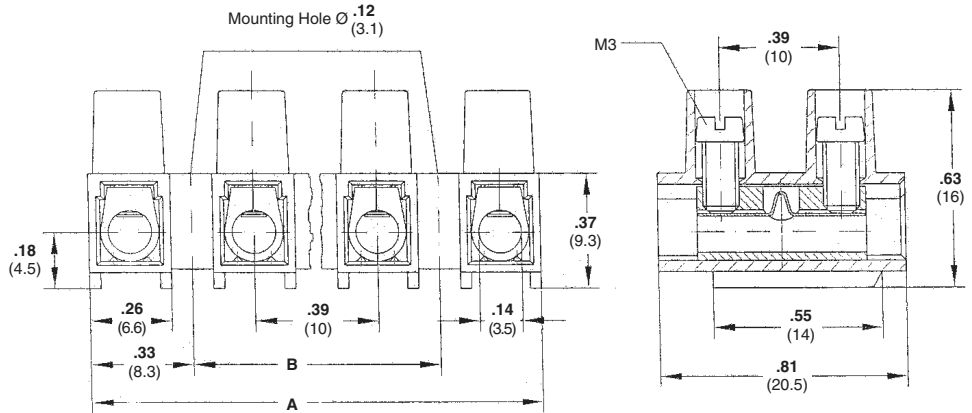

Material & Finish

- Housing Material**—Polyamide 6
- Flammability**—UL94V-2
- Color**—Natural (off white)
- Tubular Contact**—Brass, tin plated
- Screw**—Steel, M3
- Screw Plating**—Zinc with chromate
- Wire Protector**—Stainless steel

Mechanical Properties

- Pitch (terminal spacing)**—10mm [.394]
- Wire Strip Length**—5mm [0.20"]
- Min. Wire Pull-Out Force**—75lbs.
- Recommended Tightening Torque**—5 in.- lbs.
- Recommended Screwdrivers**—Stanley 1016, Sears Craftsman 41429, Xcelite R184

Electrical Properties

- UL Maximum Current**—30A; 10-22 AWG
- CSA Maximum Current**—25A; 12-24 AWG
- Operating Voltage**—250V
- Dielectric Withstand**—3500V

Environmental Properties

- Continuous Working Temperature**—-35°C to +100°C [-31°F to +212°F]

No. of Positions	Dimensions		Wire Protector	
	A	B	Part Number	Catalog Number
1	6.6 (.26)	—	1776296-1	TSB500 0131DS
2	16.6 (.65)	—	1776296-2	TSB500 0231DS
3	26.6 (1.05)	10 (.39)	1776296-3	TSB500 0331DS
4	36.6 (1.44)	20 (.79)	1776296-4	TSB500 0431DS
5	46.6 (1.83)	30 (1.18)	1776296-5	TSB500 0531DS
6	56.6 (2.23)	40 (1.57)	1776296-6	TSB500 0631DS
7	66.6 (2.62)	50 (1.97)	1776296-7	TSB500 0731DS
8	76.6 (3.02)	60 (2.36)	1776296-8	TSB500 0831DS
9	86.6 (3.41)	70 (2.76)	1776296-9	TSB500 0931DS
10	96.6 (3.80)	80 (3.15)	1-1776296-0	TSB500 1031DS
11	106.6 (4.20)	90 (3.54)	1-1776296-1	TSB500 1131DS
12	116.6 (4.59)	100 (3.94)	1-1776296-2	TSB500 1231DS

Europa Terminal Blocks **5**



10mm [.394] Pitch, 30A with Tunnel Connection—Series TSB500



Material & Finish

- Housing Material**—Polyamide 6
- Flammability**—UL94V-2
- Color**—Natural (off white)
- Tubular Contact**—Brass, tin plated
- Screw**—Steel, M3
- Screw Plating**—Zinc with chromate

Mechanical Properties

- Pitch (terminal spacing)**—10mm [.394]
- Wire Strip Length**—5mm [0.20"]
- Min. Wire Pull-Out Force**—75lbs.
- Recommended Tightening Torque**—5 in.-lbs.
- Recommended Screwdrivers**—Stanley 1016, Sears Craftsman 41429, Xcelite R184

Electrical Properties

- Maximum Current**—30A
- Operating Voltage**—250V
- Wire Range**—10-22 AWG
- Dielectric Withstand**—3500V

Environmental Properties

- Continuous Working Temperature**—-35°C to +100°C [-31°F to +212°F]

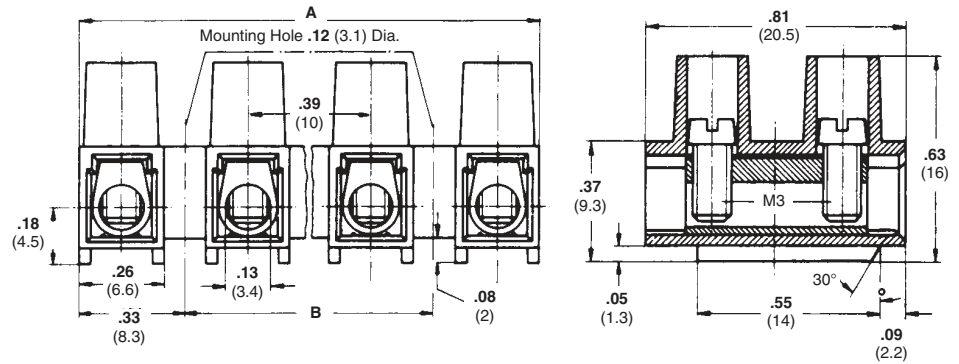

No. of Positions	Dimensions		Tunnel Connection	
	A	B	Part Number	Catalog Number
1	6.6 (.26)	—	—	TSB500 0131
2	16.6 (.65)	—	1776297-2	TSB500 0231
3	26.6 (1.05)	10 (.39)	1776297-3	TSB500 0331
4	36.6 (1.44)	20 (.79)	1776297-4	TSB500 0431
5	46.6 (1.83)	30 (1.18)	1776297-5	TSB500 0531
6	56.6 (2.23)	40 (1.57)	1776297-6	TSB500 0631
7	66.6 (2.62)	50 (1.97)	1776297-7	TSB500 0731
8	76.6 (3.02)	60 (2.36)	1776297-8	TSB500 0831
9	86.6 (3.41)	70 (2.76)	1776297-9	TSB500 0931
10	96.6 (3.80)	80 (3.15)	1-1776297-0	TSB500 1031
11	106.6 (4.20)	90 (3.54)	1-1776297-1	TSB500 1131
12	116.6 (4.59)	100 (3.94)	1-1776297-2	TSB500 1231



Note: All part numbers are RoHS Compliant.

10mm [.394] Pitch, 30A High Temperature—Series TSB500...HT

Europa Terminal Blocks **5**

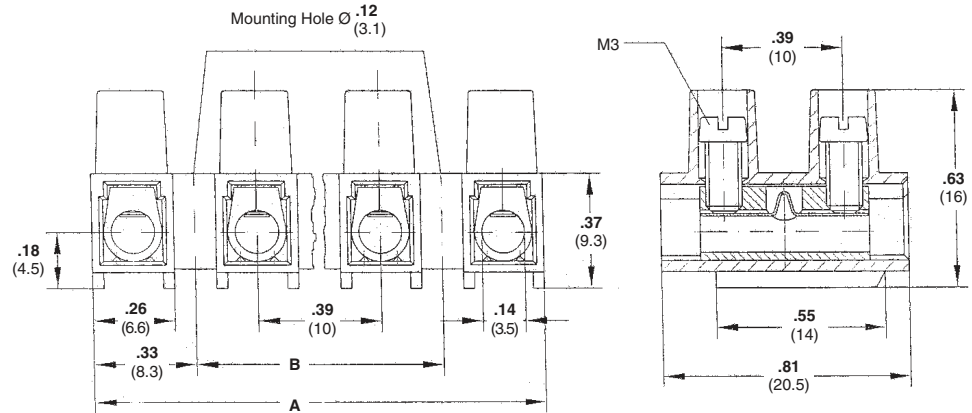
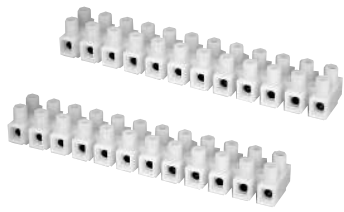

Material & Finish

- Housing Material**—Polyamide 6/6
- Flammability**—UL94V-0
- Housing Color**—Brown
- Tubular Contact**—Brass, tin plated
- Screw**—Steel, M3
- Screw Plating**—Zinc with chromate
- Wire Protector**—Stainless steel

Mechanical Properties

- Pitch (terminal spacing)**—10mm [.394]
- Wire Strip Length**—5mm [0.20"]
- Min. Wire Pull-Out Force**—75lbs.
- Recommended Tightening Torque**—5 in.- lbs.
- Recommended Screwdrivers**—Stanley 1016, Sears Craftsman 41429, Xcelite R184

Electrical Properties

- Maximum Current**—30A
- Operating Voltage**—250V
- Wire Range**—12-24 AWG
- Dielectric Withstand**—3500V

Environmental Properties

- Continuous Working Temperature**—-50°C to +160°C [-58°F to +320°F]

No. of Positions	Dimensions		Wire Protector	
	A	B	Part Number	Catalog Number
1	6.6 (.26)	—	1776298-1	TSB500 0131DS HT
2	16.6 (.65)	—	1776298-2	TSB500 0231DS HT
3	26.6 (1.05)	10 (.39)	1776298-3	TSB500 0331DS HT
4	36.6 (1.44)	20 (.79)	1776298-4	TSB500 0431DS HT
5	46.6 (1.83)	30 (1.18)	1776298-5	TSB500 0531DS HT
6	56.6 (2.23)	40 (1.57)	1776298-6	TSB500 0631DS HT
7	66.6 (2.62)	50 (1.97)	1776298-7	TSB500 0731DS HT
8	76.6 (3.02)	60 (2.36)	1776298-8	TSB500 0831DS HT
9	86.6 (3.41)	70 (2.76)	1776298-9	TSB500 0931DS HT
10	96.6 (3.80)	80 (3.15)	1-1776298-0	TSB500 1031DS HT
11	106.6 (4.20)	90 (3.54)	1-1776298-1	TSB500 1131DS HT
12	116.6 (4.59)	100 (3.94)	1-1776298-2	TSB500 1231DS HT

Note: Minimum order quantities may apply.



10mm [.394] Pitch, 30A Elongated Plastic—Series TSB500SK

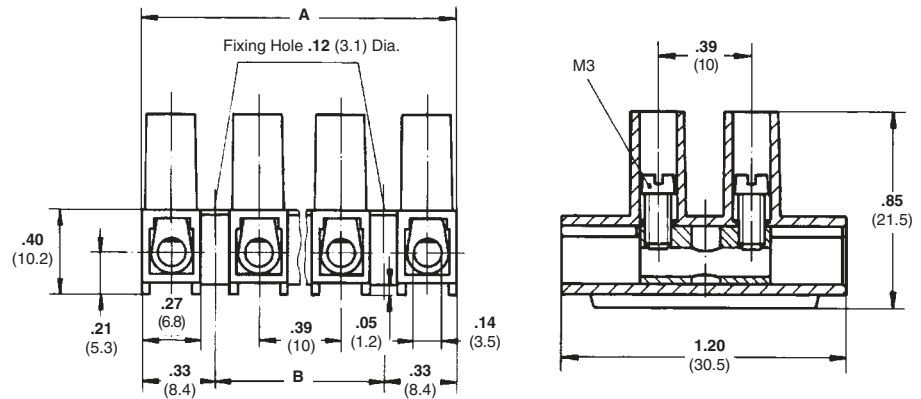

Tunnel Connection Version shown

Material & Finish

- Housing Material**—Polyamide 6
- Flammability**—UL94V-2
- Color**—natural (off white)
- Tubular Contact**—Brass, tin plated
- Screw**—Steel, M3
- Screw Plating**—Zinc with chromate
- Wire Protector**—Stainless steel

Mechanical Properties

- Pitch (terminal spacing)**—10mm [.394"]
- Wire Strip Length**—5mm [0.20"]
- Min. Wire Pull-Out Force**—5 lbs.
- Recommended Tightening Torque**—5 in.- lbs.
- Recommended Screwdrivers**—Stanley 1016, Sears Craftsman 41429, Xcelite R184

Electrical Properties

- Maximum Current**—30A (UL), 25A (CSA)
- Operating Voltage**—600V
- Wire Range**—Wire Protector—12-24 AWG
Tunnel Connection—10-22 AWG
- Dielectric Withstand**—3500V

Environmental Properties

- Continuous Working Temperature**—-35°C to +100°C [-31°F to +212°F]

No. of Positions	Dimensions		Tunnel Connection		Wire Protector	
	A	B	Part Number	Catalog Number	Part Number	Catalog Number
1	6.6 (.26)	—	1776299-1	TSB500 SK01	1776300-1	TSB500 SK01MDS
2	16.6 (.65)	—	1776299-2	TSB500 SK02	1776300-2	TSB500 SK02MDS
3	26.6 (1.05)	10 (.39)	1776299-3	TSB500 SK03	1776300-3	TSB500 SK03MDS
4	36.6 (1.44)	20 (.79)	1776299-4	TSB500 SK04	1776300-4	TSB500 SK04MDS
5	46.6 (1.83)	30 (1.18)	1776299-5	TSB500 SK05	1776300-5	TSB500 SK05MDS
6	56.6 (2.23)	40 (1.57)	1776299-6	TSB500 SK06	1776300-6	TSB500 SK06MDS
7	66.6 (2.62)	50 (1.97)	1776299-7	TSB500 SK07	1776300-7	TSB500 SK07MDS
8	76.6 (3.02)	60 (2.36)	1776299-8	TSB500 SK08	1776300-8	TSB500 SK08MDS
9	86.6 (3.41)	70 (2.76)	1776299-9	TSB500 SK09	1776300-9	TSB500 SK09MDS
10	96.6 (3.80)	80 (3.15)	1-1776299-0	TSB500 SK10	1-1776300-0	TSB500 SK10MDS
11	106.6 (4.20)	90 (3.54)	1-1776299-1	TSB500 SK11	1-1776300-1	TSB500 SK11MDS
12	116.6 (4.59)	100 (3.94)	1-1776299-2	TSB500 SK12	1-1776300-2	TSB500 SK12MDS

Note: Add suffix HT for High Temperature version. Minimum order quantities may apply. Flammability: UL94V-0. Continuous working temperature: 150°C.



Note: All part numbers are RoHS Compliant.

10mm [.394] Pitch, Fused Terminal Blocks—Series 503Si



Material & Finish

Housing Material—Polyamide 6/6

Color—Gray, handle is black

Tubular Contact—Brass, tin plated

Screw—Steel

Screw Plating—Zinc with chromate

Wire Protector—Stainless steel

Contacts for Fuses—Stainless steel spring

Tunnel Connection—Without wire protector

Mechanical Properties

Pitch (terminal spacing)—10mm [.394"]

Wire Strip Length—7mm [.276"]

Electrical Properties

Maximum Current—

To VDE 820—Fuse Holder 10A

To VDE 0100—Terminal Blocks 26A

To VDE 0700/0711—Terminal Blocks 10A

Operating Voltage—

Fuse Holder—250V

Terminal Blocks—400V

Wire Range—

Wire Protector—12-22 AWG

Tunnel Connection—12-22 AWG

Environmental Properties

Continuous Working Temperature—

-35°C to +100°C [-31°F to +212°F]

500Si/1 (1 Circuit)

503Si (2-5 Circuits)

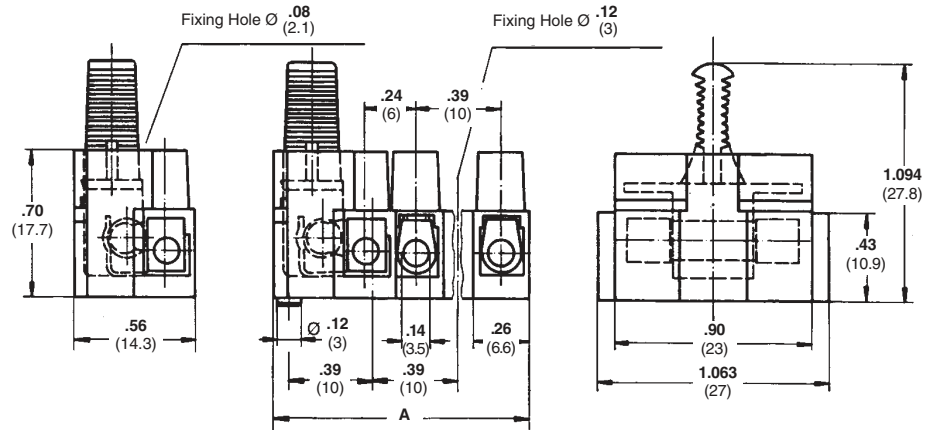

Series 503Si & 503Si...DS version of TSB500 Series with an integrated fuse holder for 5 x 20mm [.197 x .787] fuses. Protection against unintentional touch of live parts to VBG4 and VDE 0106, part 100 and VDE 0470, part 1.

Series 503Si...E & 503Si...EDS include a ground connection.

No. of Positions	Dim. A	Tunnel Connection		Wire Protector		Tunnel Connection Grounded		Wire Protector Grounded	
		Part Number	Catalog Number	Part Number	Catalog Number	Part Number	Catalog Number	Part Number	Catalog Number
1	14.3 (.56)	1776301-1	503Si 1	1776301-6	503Si 1DS	—	—	—	—
2	20 (.79)	1776301-2	503Si 2	1776301-7	503Si 2DS	—	—	—	—
3	30 (1.18)	—	503Si 3	1776301-8	503Si 3DS	—	503Si 3E	2-1776301-3	503Si 3EDS
4	40 (1.58)	—	503Si 4	1776301-9	503Si 4DS	1-1776301-4	503Si 4E	—	503Si 4EDS
5	50 (1.97)	1776301-5	503Si 5	1-1776301-0	503Si 5DS	—	503Si 5E	—	503Si 5EDS

Note: All part numbers are RoHS Compliant.

12mm [.472] Pitch, 40A with Wire Protector—Series TSB1000



Material & Finish

- Housing Material**—Polyamide 6
- Flammability**—UL94V-2
- Color**—Natural (off white)
- Tubular Contact**—Brass, tin plated
- Screw**—Steel, M3.5
- Screw Plating**—Zinc with chromate
- Wire Protector**—Stainless steel

Mechanical Properties

- Pitch (terminal spacing)**—12mm [.472"]
- Wire Strip Length**—7mm [.28"]
- Min. Wire Pull-Out Force**—125 lbs.
- Recommended Tightening Torque**—10 in.-lbs.
- Recommended Screwdrivers**—Stanley 1016, Sears Craftsman 41429, Xcelite R184

Electrical Properties

- Maximum Current**—40A
- Operating Voltage**—250V
- Wire Range**—10-22 AWG
- Dielectric Withstand**—4500V

Environmental Properties

- Continuous Working Temperature**—-35°C to +100°C [-31°F to +212°F]

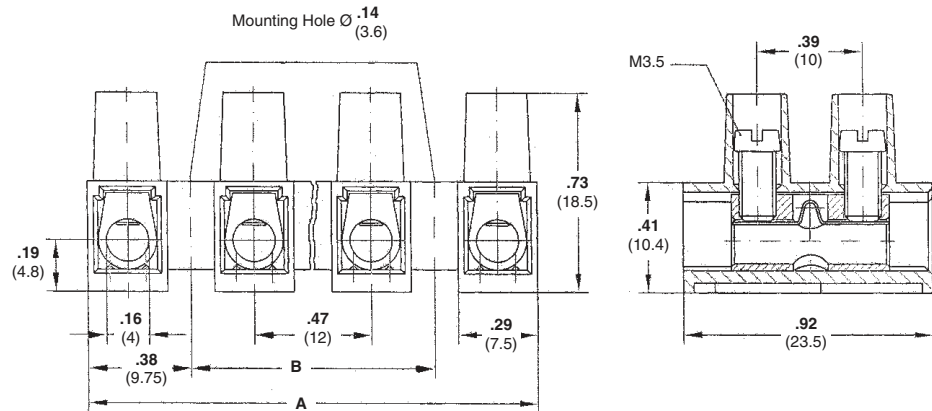

No. of Positions	Dimensions		Wire Protector	
	A	B	Part Number	Catalog Number
1	7.5 (.30)	—	1776302-1	TSB1000 01DS
2	19.5 (.77)	—	1776302-2	TSB1000 02DS
3	31.5 (1.24)	12 (.47)	1776302-3	TSB1000 03DS
4	43.5 (1.71)	24 (.95)	1776302-4	TSB1000 04DS
5	55.5 (2.19)	36 (1.42)	1776302-5	TSB1000 05DS
6	67.5 (2.66)	48 (1.89)	1776302-6	TSB1000 06DS
7	79.5 (3.13)	60 (2.36)	1776302-7	TSB1000 07DS
8	91.5 (3.60)	72 (2.83)	1776302-8	TSB1000 08DS
9	103.5 (4.07)	84 (3.31)	1776302-9	TSB1000 09DS
10	115.5 (4.55)	96 (3.78)	1-1776302-0	TSB1000 10DS
11	127.5 (5.02)	108 (4.25)	1-1776302-1	TSB1000 11DS
12	139.5 (5.49)	120 (4.72)	1-1776302-2	TSB1000 12DS

12mm [.472] Pitch, 50A with Tunnel Connection—Series TSB1000

Europa Terminal Blocks **5**



Material & Finish

- Housing Material**—Polyamide 6
- Flammability**—UL94V-2
- Color**—Natural (off white)
- Tubular Contact**—Brass, tin plated
- Screw**—Steel, M3.5
- Screw Plating**—Zinc with chromate

Mechanical Properties

- Pitch (terminal spacing)**—12mm [.472"]
- Wire Strip Length**—7mm [.28"]
- Min. Wire Pull-Out Force**—125 lbs.

Recommended Tightening Torque—10 in.- lbs.

Recommended Screwdrivers—Stanley 1016, Sears Craftsman 41429, Xcelite R184

Electrical Properties

- Maximum Current**—50A
- Operating Voltage**—250V
- Wire Range**—8-22 AWG
- Dielectric Withstand**—4500V

Environmental Properties

Continuous Working Temperature—-35°C to +100°C [-31°F to +212°F]

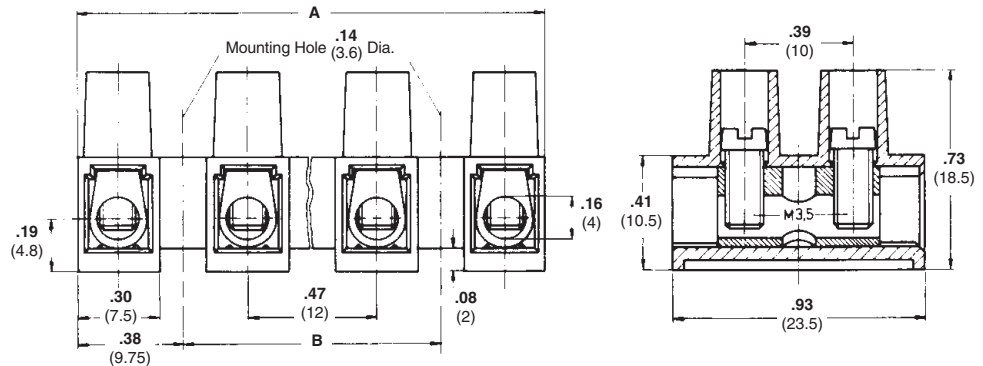

No. of Positions	Dimensions		Tunnel Connection	
	A	B	Part Number	Catalog Number
1	7.5 (.30)	—	1776303-1	TSB1000 01
2	19.5 (.77)	—	1776303-2	TSB1000 02
3	31.5 (1.24)	12 (.47)	1776303-3	TSB1000 03
4	43.5 (1.71)	24 (.95)	1776303-4	TSB1000 04
5	55.5 (2.19)	36 (1.42)	1776303-5	TSB1000 05
6	67.5 (2.66)	48 (1.89)	1776303-6	TSB1000 06
7	79.5 (3.13)	60 (2.36)	1776303-7	TSB1000 07
8	91.5 (3.60)	72 (2.84)	1776303-8	TSB1000 08
9	103.5 (4.07)	84 (3.31)	1776303-9	TSB1000 09
10	115.5 (4.55)	96 (3.78)	1-1776303-0	TSB1000 10
11	127.5 (5.02)	108 (4.25)	1-1776303-1	TSB1000 11
12	139.5 (5.49)	120 (4.72)	1-1776303-2	TSB1000 12



12mm [.472] Pitch, 40A High Temperature—Series TSB1000...HT

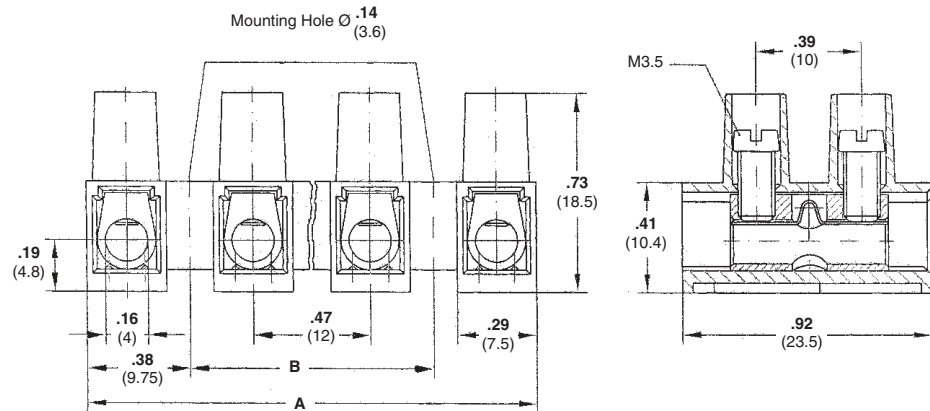
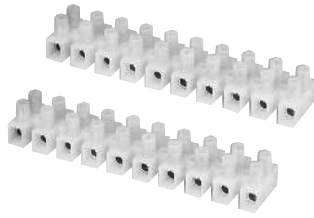

Material & Finish

- Housing Material**—Polyamide 6/6
- Flammability**—UL94V-0
- Housing Color**—Brown
- Tubular Contact**—Brass, tin plated
- Screw**—Steel, M3.5
- Screw Plating**—Zinc with chromate
- Wire Protector**—Stainless steel

Mechanical Properties

- Pitch (terminal spacing)**—12mm [.472"]
- Wire Strip Length**—7mm [.28"]
- Min. Wire Pull-Out Force**—125 lbs.
- Recommended Tightening Torque**—10 in.-lbs.
- Recommended Screwdrivers**—Stanley 1016, Sears Craftsman 41429, Xcelite R184

Electrical Properties

- Maximum Current**—40A
- Operating Voltage**—250V
- Wire Range**—10-24 AWG
- Dielectric Withstand**—4500V

Environmental Properties

- Continuous Working Temperature**—-50°C to +160°C [-58°F to +320°F]

No. of Positions	Dimensions		Wire Protector	
	A	B	Part Number	Catalog Number
1	7.5 (.30)	—	—	TSB1000 01DS HT
2	19.5 (.77)	—	1776304-2	TSB1000 02DS HT
3	31.5 (1.24)	12 (.47)	1776304-3	TSB1000 03DS HT
4	43.5 (1.71)	24 (.95)	1776304-4	TSB1000 04DS HT
5	55.5 (2.19)	36 (1.42)	1776304-5	TSB1000 05DS HT
6	67.5 (2.66)	48 (1.89)	1776304-6	TSB1000 06DS HT
7	79.5 (3.13)	60 (2.36)	1776304-7	TSB1000 07DS HT
8	91.5 (3.60)	72 (2.84)	1776304-8	TSB1000 08DS HT
9	103.5 (4.07)	84 (3.31)	1776304-9	TSB1000 09DS HT
10	115.5 (4.55)	96 (3.78)	1-1776304-0	TSB1000 10DS HT
11	127.5 (5.02)	108 (4.25)	1-1776304-1	TSB1000 11DS HT
12	139.5 (5.49)	120 (4.72)	1-1776304-2	TSB1000 12DS HT



Note: All part numbers are RoHS Compliant.

12mm [.472] Pitch, Fused Terminal Blocks—Series 1003Si



Material & Finish

- Housing Material**—Polyamide 6/6
- Color**—Gray, handle is black
- Tubular Contact**—Brass, tin plated
- Screw**—Steel
- Screw Plating**—Zinc with chromate
- Wire Protector**—Stainless steel
- Contacts for Fuses**—Stainless steel screw
- Tunnel Connection**—Without wire protector

Mechanical Properties

- Pitch (terminal spacing)**—12mm [.472"]
- Wire Strip Length**—7.5mm [.295"]

Electrical Properties

- Maximum Current**—
To VDE 0820—Fuse Holder 16A
To VDE 0100—Terminal Blocks 34A
To VDE 0700/0711—Terminal Blocks 16A

Operating Voltage—

- Fuse Holder—250V
- Terminal Blocks—400V

Wire Range—

- Wire Protector—up to 10mm² (10-24 AWG)
- Tunnel Connection—up to 4mm² (8-22 AWG)

Environmental Properties

Continuous Working Temperature—

-35°C to +100°C [-31°F to +212°F]

1003Si/1 (1 Circuit)

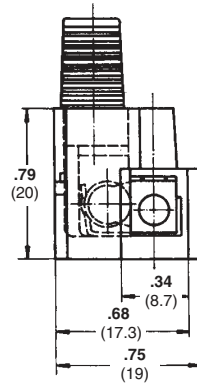

1003Si (2-5 Circuits)

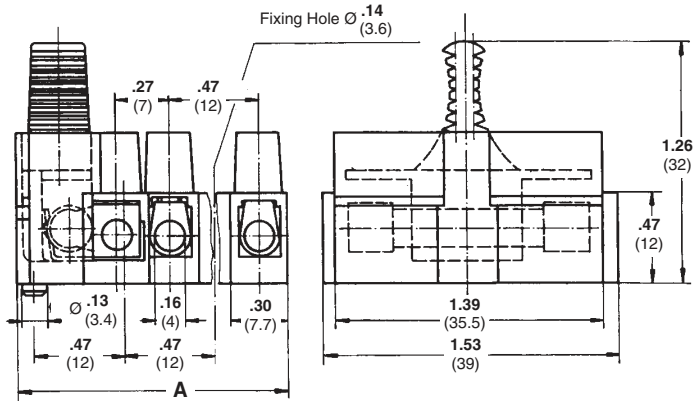

Series 1003Si & 1003Si...DS version of TSB1000 Series with an integrated fuse holder for 1/4" x 1" (6.3 x 25mm) or 1/4" x 1 1/4" (6.3mm x 32mm). Protection against unintended touch of live parts to VBG4.

Series 1003Si...E & 1003Si...EDS include a ground connection.

No. of Positions	Dim. A	Tunnel Connection		Wire Protector		Tunnel Connection Grounded		Wire Protector Grounded	
		Part Number	Catalog Number	Part Number	Catalog Number	Part Number	Catalog Number	Part Number	Catalog Number
1	18.7 (.74)	1-1776309-1	1003Si 1	1776309-1	1003Si 1DS	—	—	—	—
2	24 (0.95)	1-1776309-2	1003Si 2	1776309-2	1003Si 2DS	—	—	—	—
3	36 (1.42)	1-1776309-3	1003Si 3	—	1003Si 3DS	1776309-3	1003Si 3E	1776309-4	1003Si 3EDS
4	48 (1.89)	1-1776309-4	1003Si 4	—	1003Si 4DS	—	1003Si 4E	—	1003Si 4EDS
5	60 (2.36)	1-1776309-5	1003Si 5	—	1003Si 5DS	—	1003Si 5E	—	1003Si 5EDS

13.5mm [.531] Pitch, 40A—Series TSB1500



Material & Finish

- Housing Material**—Polyamide 6
- Flammability**—UL94V-2
- Color**—Natural (off white)
- Tubular Contact**—Brass, tin plated
- Screw**—Steel
- Screw Plating**—Zinc with chromate
- Wire Protector**—Stainless steel
- Tunnel Connection**—Without wire protector

Mechanical Properties

- Pitch (terminal spacing)**—13.5mm [.531"]
- Wire Strip Length**—8mm [.315"]
- Recommended Tightening Torque**—10 in.-lbs.
- Recommended Screwdrivers**—Stanley 1016, Sears Craftsman 41429, Xcelite R184

Electrical Properties

- Maximum Current**—40A (UR); 55A (CSA)
- Operating Voltage**—300V
- Wire Range**—Wire Protector—8-18 AWG
Tunnel Connection—8-16 AWG

Environmental Properties

- Continuous Working Temperature**—-35°C to +100°C [-31°F to +212°F]

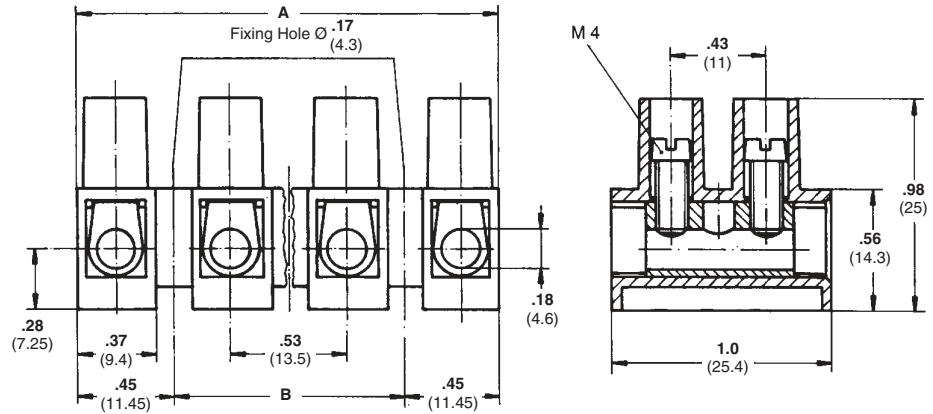

Tunnel Connection Version shown

No. of Positions	Dimensions		Tunnel Connection		Wire Protector	
	A	B	Part Number	Catalog Number	Part Number	Catalog Number
1	9.4 (.37)	—	1776310-1	TSB1500 01	1776311-1	TSB1500 01DS
2	22.9 (.90)	—	1776310-2	TSB1500 02	1776311-2	TSB1500 02DS
3	36.4 (1.43)	13.5 (.53)	1776310-3	TSB1500 03	1776311-3	TSB1500 03DS
4	49.9 (1.96)	27.0 (1.06)	1776310-4	TSB1500 04	1776311-4	TSB1500 04DS
5	63.4 (2.49)	40.5 (1.59)	1776310-5	TSB1500 05	1776311-5	TSB1500 05DS
6	76.9 (3.03)	54.0 (2.12)	1776310-6	TSB1500 06	1776311-6	TSB1500 06DS
7	90.4 (3.55)	67.5 (2.65)	1776310-7	TSB1500 07	1776311-7	TSB1500 07DS
8	103.9 (4.09)	81.0 (3.19)	1776310-8	TSB1500 08	1776311-8	TSB1500 08DS
9	117.4 (4.62)	94.5 (3.72)	1776310-9	TSB1500 09	1776311-9	TSB1500 09DS
10	130.9 (5.15)	108.0 (4.25)	1-1776310-0	TSB1500 10	1-1776311-0	TSB1500 10DS
11	144.4 (5.68)	121.5 (4.78)	1-1776310-1	TSB1500 11	1-1776311-1	TSB1500 11DS
12	157.9 (6.21)	135.0 (5.31)	1-1776310-2	TSB1500 12	1-1776311-2	TSB1500 12DS



Note: All part numbers are RoHS Compliant.

14.5mm [.571] Pitch, 65A—Series TSB2000

Europe Terminal Blocks **5**

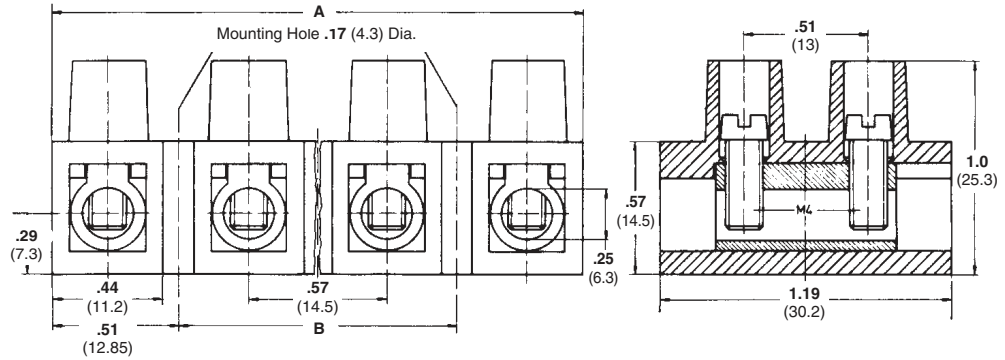

Tunnel Connection Version shown

Material & Finish

- Housing Material**—Polyamide 6
- Flammability**—UL94V-2
- Color**—Natural (off white)
- Tubular Contact**—Brass, tin plated
- Screw**—Steel, M3.5
- Screw Plating**—Zinc with chromate
- Wire Protector**—Stainless steel
- Tunnel Connection**—Without wire protector

Mechanical Properties

- Pitch (terminal spacing)**—14.5mm [.571"]
- Wire Strip Length**—9mm [.35"]
- Min. Wire Pull-Out Force**—150lbs.
- Recommended Tightening Torque**—12 in.-lbs.
- Recommended Screwdrivers**—Stanley 1008, Sears Craftsman 41436, Xcelite R3164

Electrical Properties

- Maximum Current**—65A (UR), 70A (CSA)
- Operating Voltage**—300V
- Wire Range**—6-14 AWG (UR), 6-22 AWG (CSA)
- Dielectric Withstand**—6000V

Environmental Properties

- Continuous Working Temperature**—-35°C to +100°C [-31°F to +212°F]

No. of Positions	Dimensions		Tunnel Connection		Wire Protector	
	A	B	Part Number	Catalog Number	Part Number	Catalog Number
1	11.2 (.44)	—	1776312-1	TSB2000 01	1776313-1	TSB2000 01DS
2	25.7 (1.01)	—	1776312-2	TSB2000 02	1776313-2	TSB2000 02DS
3	40.2 (1.58)	14.5 (.57)	1776312-3	TSB2000 03	1776313-3	TSB2000 03DS
4	54.7 (2.15)	29.0 (1.14)	1776312-4	TSB2000 04	1776313-4	TSB2000 04DS
5	69.2 (2.72)	43.5 (1.71)	1776312-5	TSB2000 05	1776313-5	TSB2000 05DS
6	83.7 (3.30)	58.0 (2.28)	1776312-6	TSB2000 06	1776313-6	TSB2000 06DS
7	98.2 (3.87)	72.5 (2.85)	1776312-7	TSB2000 07	1776313-7	TSB2000 07DS
8	112.7 (4.44)	87.0 (3.43)	1776312-8	TSB2000 08	1776313-8	TSB2000 08DS
9	127.2 (5.01)	101.5 (4.00)	1776312-9	TSB2000 09	1776313-9	TSB2000 09DS
10	141.7 (5.58)	116.0 (4.57)	1-1776312-0	TSB2000 10	1-1776313-0	TSB2000 10DS
11	156.2 (6.15)	130.5 (5.14)	1-1776312-1	TSB2000 11	1-1776313-1	TSB2000 11DS
12	170.7 (6.72)	145.0 (5.71)	1-1776312-2	TSB2000 12	1-1776313-2	TSB2000 12DS



Note: All part numbers are RoHS Compliant.

14.5mm [.571] Pitch, 65A High Temperature—Series TSB2000...HT

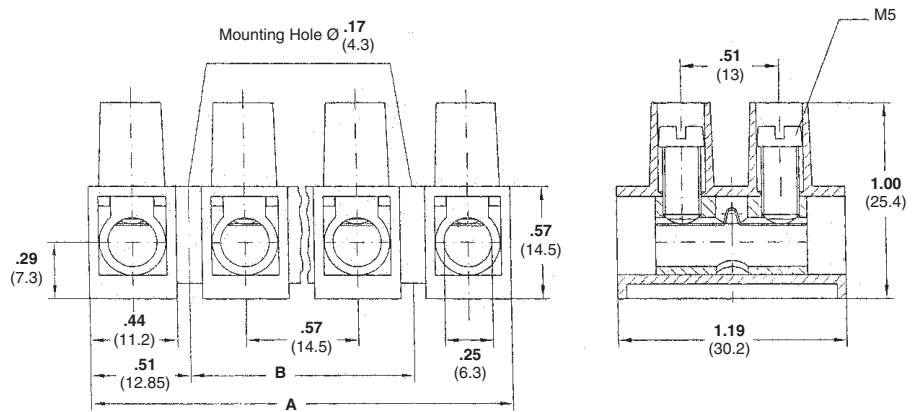
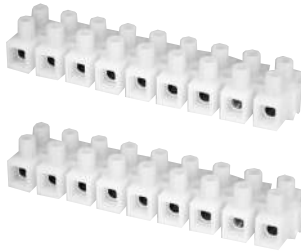

Material & Finish

- Housing Material**—Polyamide 6/6
- Flammability**—UL94V-0
- Housing Color**—Brown
- Tubular Contact**—Brass, tin plated
- Screw**—Steel, M3.5
- Screw Plating**—Zinc with chromate
- Wire Protector**—Stainless steel

Mechanical Properties

- Pitch (terminal spacing)**—14.5mm [.571"]
- Wire Strip Length**—9mm [.35"]
- Min. Wire Pull-Out Force**—150 lbs.
- Recommended Tightening Torque**—12 in.-lbs.
- Recommended Screwdrivers**—Stanley 1008, Sears Craftsman 41436, Xcelite R3164

Electrical Properties

- Maximum Current**—65A (UR), 70A (CSA)
- Operating Voltage**—300V
- Wire Range**—6-14 AWG (UR), 6-22 AWG (CSA)
- Dielectric Withstand**—6000V

Environmental Properties

- Continuous Working Temperature**—-35°C to +150°C [-31°F to +302°F]

No. of Positions	Dimensions		Wire Protector	
	A	B	Part Number	Catalog Number
1	11.2 (.44)	—	1776314-1	TSB2000 01 DSHT
2	25.7 (1.01)	—	1776314-2	TSB2000 02 DSHT
3	40.2 (1.58)	14.5 (.57)	1776314-3	TSB2000 03 DSHT
4	54.7 (2.15)	29.0 (1.14)	1776314-4	TSB2000 04 DSHT
5	69.2 (2.72)	43.5 (1.71)	1776314-5	TSB2000 05 DSHT
6	83.7 (3.30)	58.0 (2.28)	1776314-6	TSB2000 06 DSHT
7	98.2 (3.87)	72.5 (2.85)	1776314-7	TSB2000 07 DSHT
8	112.7 (4.44)	87.0 (3.43)	1776314-8	TSB2000 08 DSHT
9	127.2 (5.01)	101.5 (4.00)	1776314-9	TSB2000 09 DSHT
10	141.7 (5.58)	116.0 (4.57)	1-1776314-0	TSB2000 10 DSHT
11	156.2 (6.15)	130.5 (5.14)	1-1776314-1	TSB2000 11 DSHT
12	170.7 (6.72)	145.0 (5.71)	1-1776314-2	TSB2000 12 DSHT

Note: Minimum order quantities may apply.



14.5mm [.571] Pitch, 65A High Voltage Version—Series TSB2000...US

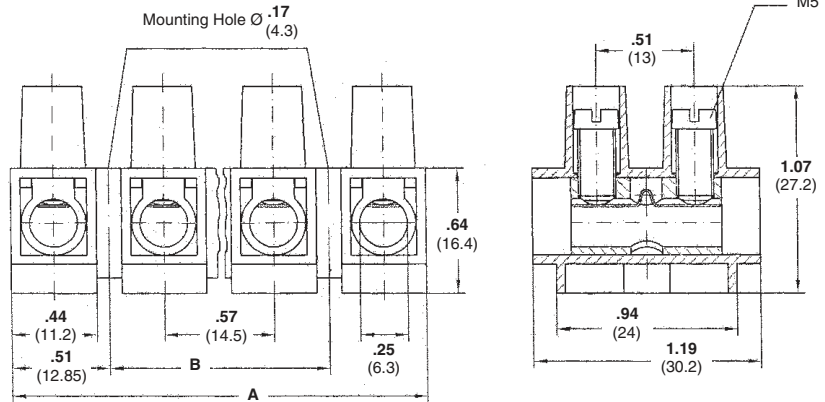

Material & Finish

- Housing Material**—Polyamide 6
- Flammability**—UL94V-2
- Color**—Natural (off white)
- Tubular Contact**—Brass, tin plated
- Screw**—Steel, M3.5
- Screw Plating**—Zinc with chromate
- Wire Protector**—Stainless Steel

Mechanical Properties

- Pitch (terminal spacing)**—14.5mm [.571"]
- Wire Strip Length**—9mm [.35"]
- Min. Wire Pull-Out Force**—150 lbs.
- Recommended Tightening Torque**—12 in.-lbs.
- Recommended Screwdrivers**—Stanley 1008, Sears Craftsman 41436, Xcelite R3164

Electrical Properties

- Maximum Current**—65A (UR), 70A (CSA)
- Operating Voltage**—600V
- Wire Range**—6-14 AWG (UR), 6-22 AWG (CSA)
- Dielectric Withstand**—6000V

Environmental Properties

- Continuous Working Temperature**—-35°C to +100°C [-31°F to +212°F]

No. of Positions	Dimensions		Wire Protector	
	A	B	Part Number	Catalog Number
1	11.2 (.44)	—	—	TSB2000 01KDS
2	25.7 (1.01)	—	1776315-2	TSB2000 02KDS
3	40.2 (1.58)	14.5 (.57)	1776315-3	TSB2000 03KDS
4	54.7 (2.15)	29.0 (1.14)	1776315-4	TSB2000 04KDS
5	69.2 (2.72)	43.5 (1.71)	1776315-5	TSB2000 05KDS
6	83.7 (3.30)	58.0 (2.28)	1776315-6	TSB2000 06KDS
7	98.2 (3.87)	72.5 (2.85)	1776315-7	TSB2000 07KDS
8	112.7 (4.44)	87.0 (3.43)	1776315-8	TSB2000 08KDS
9	127.2 (5.01)	101.5 (4.00)	1776315-9	TSB2000 09KDS
10	141.7 (5.58)	116.0 (4.57)	1-1776315-0	TSB2000 10KDS
11	156.2 (6.15)	130.5 (5.14)	1-1776315-1	TSB2000 11KDS
12	170.7 (6.72)	145.0 (5.71)	1-1776315-2	TSB2000 12KDS

Europa Terminal Blocks
5



Note: All part numbers are RoHS Compliant.

Fuse Holder (for Series TSB500, TSB1000)—Series 500Si



Material & Finish

- Housing Material**—Polyamide 6/6
- Color**—Gray
- Tubular Contact**—Brass, tin plated
- Screw**—Steel
- Screw Plating**—Zinc with chromate

Mechanical Properties

- Pitch (terminal spacing)**—10mm [.394] and 12mm [.472]
- Wire Strip Length**—6.5mm [.256]

Electrical Properties

- Maximum Current**—To VDE 0820—10A
To VDE 0700/0711—10A
- Operating Voltage**—250V
- Wire Range**—12-22 AWG

Environmental Properties

- Continuous Working Temperature**—-35°C to +100°C [-31°F to +212°F]

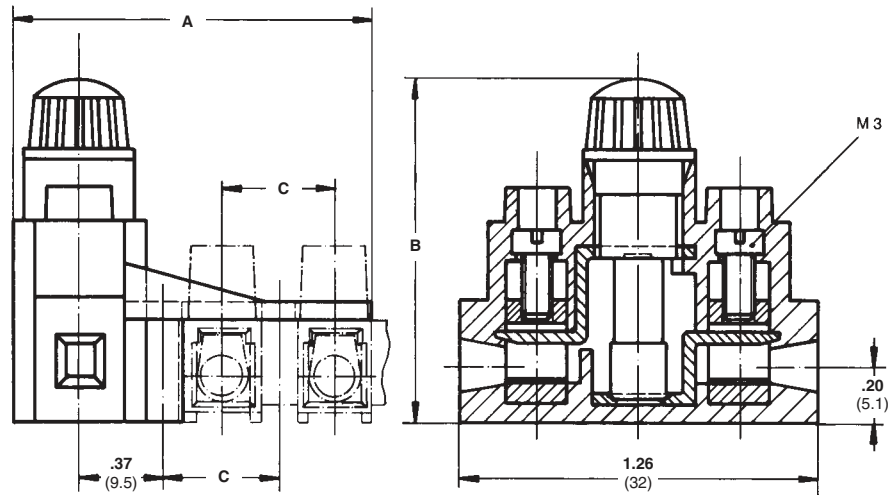

Series 500Si:

Two versions mate with TSB500 and TSB1000 to provide a fuse holder for 5 x 20mm [.197 x .787] or 5mm x 25mm [.197 x .984] fuses. These connectors comply with VDE 0820, part 2.

Series 500Si...K:

Same as the standard series but provides a raised, transparent “bayonet catch” which serves as a Fuse Link Carrier for fuses 5 x 25mm [.197 x .984] (with indicator).

Description	Dimensions			Catalog Number
	A	B	C	
For TSB500 Series	35 (1.378)	29 (1.142)	10 (.394)	500Si 5
For TSB1000 Series	37 (1.457)	30 (1.181)	12 (.472)	500Si 10
w/ Fuse Link Carrier for TSB500 Series	35 (1.378)	34 (1.339)	10 (.394)	500Si 5K
w/ Fuse Link Carrier for TSB1000 Series	37 (1.457)	35 (1.378)	12 (.472)	500Si 10K

Note: All part numbers are RoHS Compliant.

Covers—Series ABK



Material & Finish

Housing Material—Polyamide 6/6

Color—Gray

Continuous Working Temperature—100°C [212°F]

Series ABK 405, 406, & 415 Covers

These covers mate with Series TSB500, TSB1000 and TSB1500. They do not mate with TSB500 SK.

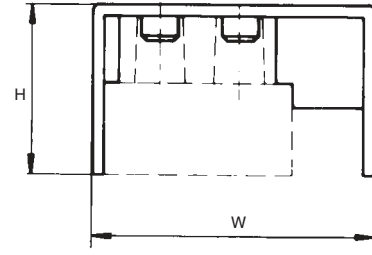
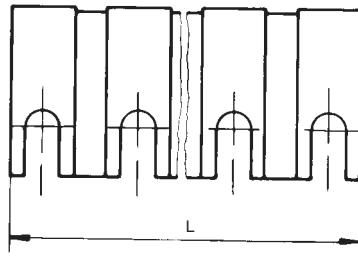

Cover for TSB500 Series

Dimensions L x W x H	Catalog Number
18 x 29 x 18.8 (.709 x 1.142 x .740)	ABK 405 02
28 x 29 x 18.8 (1.102 x 1.142 x .740)	ABK 405 03
38 x 29 x 18.8 (1.496 x 1.142 x .740)	ABK 405 04
58 x 29 x 18.8 (2.283 x 1.142 x .740)	ABK 405 06
118 x 29 x 18.8 (4.646 x 1.142 x .740)	ABK 405 12

Cover for TSB1000 Series

Dimensions L x W x H	Catalog Number
21 x 35.5 x 20.7 (.827 x 1.398 x .815)	ABK 406 02
33 x 35.5 x 20.7 (1.299 x 1.398 x .815)	ABK 406 03
45 x 35.5 x 20.7 (1.772 x 1.398 x .815)	ABK 406 04
69 x 35.5 x 20.7 (2.717 x 1.398 x .815)	ABK 406 06
141 x 35.5 x 20.7 (5.551 x 1.398 x .815)	ABK 406 12

Cover for TSB1500 Series

Dimensions L x W x H	Catalog Number
24 x 37.5 x 25.5 (.945 x 1.476 x 1.004)	ABK 415 02
37.5 x 37.5 x 25.5 (1.476 x 1.476 x 1.004)	ABK 415 03
51 x 37.5 x 25.5 (2.008 x 1.476 x 1.004)	ABK 415 04
78 x 37.5 x 25.5 (3.071 x 1.476 x 1.004)	ABK 415 06
158 x 37.5 x 25.5 (6.220 x 1.476 x 1.004)	ABK 415 12

Series ABK 503 Covers

These covers mate with Series 503Si.

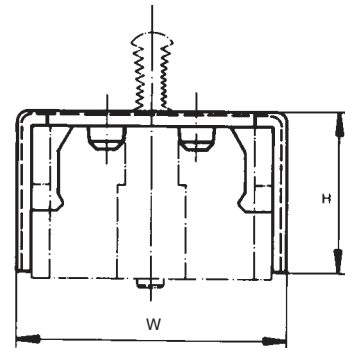
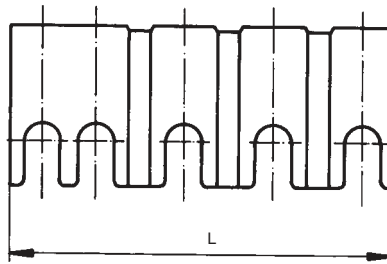

Cover for 503Si Series

Dimensions L x W x H	Catalog Number
13.5 x 30.5 x 18.5 (.531 x 1.201 x .728)	ABK 503 02
24 x 30.5 x 18.5 (.945 x 1.201 x .728)	ABK 503 03
33.5 x 30.5 x 18.5 (1.319 x 1.201 x .728)	ABK 503 04
43 x 30.5 x 18.5 (1.693 x 1.201 x .728)	ABK 503 05

Strain Relief (for Series TSB500)—Series 500...ZEL

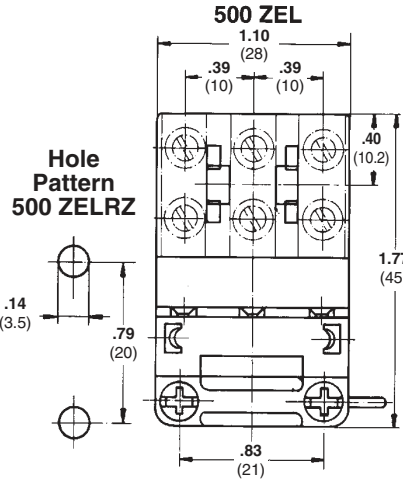

Material & Finish

Housing Material—Polyamide 6/6

Color—White

Tracking Resistance—CTI 600

Screw—Steel

Screw Plating—Zinc with yellow chromate C 2.9 x 13mm [.114 x .512]

Environmental Properties

Continuous Working

Temperature—
-35°C to +100°C [-31°F to +212°F]

Description	Part Number	Catalog Number
For Series TSB500	1546182-1	500 3ZEL
With Catch Pin for Series TSB500	1546182-2	500 3ZELRZ

Strain reliefs are provided with a captive clamping mechanism that can be rotated by 180° accommodating variable sizes of conductors. Two Phillips screws are enclosed.

A cable guide comb for TSB500 of 3 or more circuits fixes the Europa block to the strain relief. A screw mounts the Europa block to the 500 3ZEL; a catch pin mounts the block to the 500 3ZELRZ

Note: All part numbers are RoHS Compliant.

Blank Marking Labels—Series...BZ (2-12 Circuits)

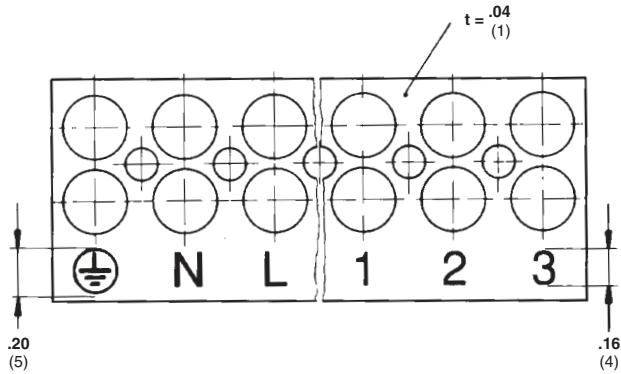

Material & Finish

Material—Roughened synthetic
Color—White
Thickness—1mm

Catalog Number				
TSB230 Series	TSB500 Series	TSB1000 Series	TSB1500 Series	TSB2000 Series
230 BZM	500 BZM	1000 BZM	1500 BZM	2000 BZM

Standard Package: 100 pieces per catalog number, 2-meter [6.56 ft] length

Each pole is provided with 2 holes allowing the marking labels to be slipped on the “chimney” tops, and with a mounting hole corresponding to the mounting hole of the connectors.

Marking Strips:

Series TSB Marking Strips are available in both Standard and Custom-cut lengths. Standard Marking Strips are supplied blank, 2 meters [6.56 ft] in length which the customer may

cut to suit individual length requirement. Custom Marking Strips are supplied pre-cut, and may be ordered blank or with printing. Marking Strips protrude from the barrier strip approximately 5mm [.197] on one side, and can be affixed to either the bottom or the top of the barrier strip.

TSB230 Series		TSB500 Series		TSB1000 Series		TSB1500 Series	TSB2000 Series
Part Number	Catalog Number	Part Number	Catalog Number	Part Number	Catalog Number	Catalog Number	Catalog Number
—	M230 BZ 02	—	M500 BZ 02	—	M1000 BZ 02	M1500 BZ 02	M2000 BZ 02
1-1437387-5	M230 BZ 03	—	M500 BZ 03	—	M1000 BZ 03	M1500 BZ 03	M2000 BZ 03
1-1437387-6	M230 BZ 04	—	M500 BZ 04	—	M1000 BZ 04	M1500 BZ 04	M2000 BZ 04
—	M230 BZ 05	—	M500 BZ 05	—	M1000 BZ 05	M1500 BZ 05	M2000 BZ 05
—	M230 BZ 06	2-1437387-3	M500 BZ 06	—	M1000 BZ 06	M1500 BZ 06	M2000 BZ 06
—	M230 BZ 07	—	M500 BZ 07	—	M1000 BZ 07	M1500 BZ 07	M2000 BZ 07
—	M230 BZ 08	—	M500 BZ 08	1546830-8	M1000 BZ 08	M1500 BZ 08	M2000 BZ 08
1-1437387-7	M230 BZ 09	—	M500 BZ 09	—	M1000 BZ 09	M1500 BZ 09	M2000 BZ 09
1-1437387-8	M230 BZ 10	—	M500 BZ 10	—	M1000 BZ 10	M1500 BZ 10	M2000 BZ 10
—	M230 BZ 11	—	M500 BZ 11	—	M1000 BZ 11	M1500 BZ 11	M2000 BZ 11
1-1437387-9	M230 BZ 12	2-1437387-4	M500 BZ 12	1437387-6	M1000 BZ 12	M1500 BZ 12	M2000 BZ 12

Standard Package: 250 pieces per catalog number

Note: All part numbers
are RoHS Compliant.

Engineering Notes



Note: All part numbers are RoHS Compliant.









Table of Contents—NEMA ETB

Overview (Selector Chart)	240-243
Catalog Numbering Code	244
Miniature Blocks, 100 Series	245-248
Medium Duty, 900 Series/ERT Series (Radiation Resistant)	249-257
Heavy Duty, 200 Series	259-266
Heavy Duty, Phenolic, 200 Series	267-272
Intermediate Heavy Duty, 800 Series	273-276
Ultra Heavy Duty, 400 Series	277-279
Fuse & Switch	281-288
One-Piece Phenolic Blocks	289-292
Accessories	293
Technical Summary	294-295
UL 1059 Basic Voltage Rating	296

NEMA ETB Selector Chart

High Density Series 100



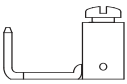





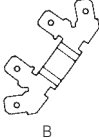
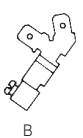

Medium Duty Series 900

							
	High Density Miniature	High Density Single Tier	High Density Double Tier	Medium Duty			
Mounting	Direct Mount, Miniature Channel	Direct Mount, Standard & Breakaway Channel	Channel only: Standard & Breakaway	Direct Mount Standard, Miniature & Breakaway Channels			
AWG Wire Range	#30-12	#30-12	#30-12	#22-8	#22-8	10*, #22-14	#22-10
Contact Types		Tubular Clamp		Tubular Clamp	Tubular Screw	Strap Screw	Plug-In
R =Shipped with screws raised B =Shipped with screws bottomed		 B		 B	 B	 B	
Ampacity	28A	28A	25A	30A	50A	35A*, 15A	30A
Voltage	300 V 600 V (Limited Power Circuits)	600 V	600 V	600 V	600 V	600 V	600 V
Center-to-Center Spacing	.25" [6.35]	.25" [6.35]	.24" [6.10]	.375" [9.53]	.375" [9.53]	.375" [9.53]	.375" [9.53]
Housing Material	Nylon or Polypropylene	Nylon	Nylon	PCT	PCT	PCT	PCT
Flammability Rating	UL94V-2 or UL94V-0	UL94V-2	UL94V-2	UL94V-0	UL94V-0	UL94V-0	UL94V-0
Max. Service Temperature	125°C (257°F) or 105°C (222°F)	125°C (257°F)	125°C (257°F)	150°C (302°F)	150°C (302°F)	150°C (302°F)	150°C (302°F)
Pages		246		250	250	250	251

*Acceptable for 35A max. factory wiring only when used with 10AWG wire preterminated with suitable ring tongue terminals.

Note: All part numbers are RoHS Compliant.











NEMA ETB Selector Chart (Continued)

	Medium Duty Series 900		ERT Series			Heavy Duty Series 200			
									
	Medium Duty		Medium Duty Radiation Resistant			Nylon or Polypropylene			
Mounting	Direct Mount Standard, Miniature & Breakaway Channels		Standard and Breakaway Channels			Direct Mount or: Flat Base fits Miniature Channel. Dovetail Base fits Standard & Breakaway Channels			
AWG Wire Range	—	#18-12	#22-8	#22-8	#10*, #22-14	#18-6 smaller	#18-4	#18-8	#10 & smaller
Contact Types	Quick Connect	Tubular Quick Connect Combination	Tubular Clamp	Tubular Screw	Strap Screw	Tubular Clamp	Tubular Screw	Strap Clamp	Strap Screw
R= Shipped with screws raised B= Shipped with screws bottomed									
Ampacity	20A	20A	30A	50A	35A*, 15A	65A	85A	50A	35A
Voltage	300 V		600 V			600 V			
Center-to-Center Spacing	.375" [9.53]		.375" [9.53]			.50" [12.70]			
Housing Material	PCT		RYTON			Nylon or Polypropylene			
Flammability Rating	UL94V-0		UL94V-0			UL94V-2 or UL94V-0			
Max. Service Temperature	150°C (302°F)		200°C (392°F)			125°C (257°F) or 105°C (222°F)			
Pages	250	251	252			260-261			



Note: All part numbers are RoHS Compliant.

NEMA ETB Selector Chart (Continued)

	Heavy Duty Series 200				Intermediate HD Series 800		Ultra Heavy Duty Series 400	
								
	Phenolic				Intermediate Heavy Duty		Ultra Heavy Duty	
Mounting	Direct Mount or Standard & Breakaway Channels				Direct Mount or Standard & Breakaway Channels		Direct Mount or Standard & Breakaway Channels	
AWG Wire Range	#18-6	#18-4	#18-8	#10 & smaller	#12-1/0		#12-2/0 kcmil (MCM)	
Contact Types	Tubular Clamp	Tubular Screw	Strap Clamp	Strap Screw	Tubular Screw		Tubular Screw	Tubular Screw
R =Shipped with screws raised B =Shipped with screws bottomed	 B	 R	 B	 B	 B		 R	 R
Ampacity	65A	85A	50A	35A	150A		175A	255A
Voltage	600 V				600 V		600 V	
Center-to-Center Spacing	.56" [14.22]				.75" [19.05]		1.19" [30.23]	
Housing Material	Phenolic				Nylon		Phenolic	
Flammability Rating	UL94V-1				UL94V-2		UL94V-1	
Max. Service Temperature	150°C (302°F)				125°C (257°F)		150°C (302°F)	
Pages	267-272				273-276		277-279	







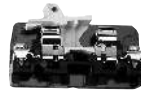

Note: All part numbers are RoHS Compliant.

NEMA ETB Selector Chart (Continued)

Fuse and Switch Series 300

One-Piece



	Nylon or Polypropylene			Phenolic			One-Piece		
Mounting	Direct Mount or Standard & Breakaway Channels			Direct Mount or Standard & Breakaway Channels			Direct Mount		
AWG Wire Range	#18-8	#18-8	#8	#18-8 & Smaller	#18-8	#8 & Smaller	#6	#8	#8
Contact Types	Tubular Screw	Strap Clamp	Strap Screw	Tubular Screw	Strap Clamp	Strap Screw	Tubular Clamp	Strap Clamp	Strap Screw
R= Shipped with screws raised B= Shipped with screws bottomed	 B	 B	 B	 B	 B	 B	 B	 B	 B
Ampacity	15A Switch 30A Fuse			15A Switch 30A Fuse			70A	50A	50A
Voltage	600 V			600 V			600 V		
Center-to-Center Spacing	.75" [19.05]			.75" [19.05]			.63" [16.00]		
Housing Material	Nylon or Polypropylene			Phenolic			Phenolic		
Flammability Rating	UL94V-2 or UL94V-0			UL94V-1			UL94V-1		
Max. Service Temperature	125°C (257°F) or 105°C (222°F)			150°C (302°F)			150°C (302°F)		
Pages	282-285			286-288			289-292		

Note: All part numbers are RoHS Compliant.

Catalog Numbering Code

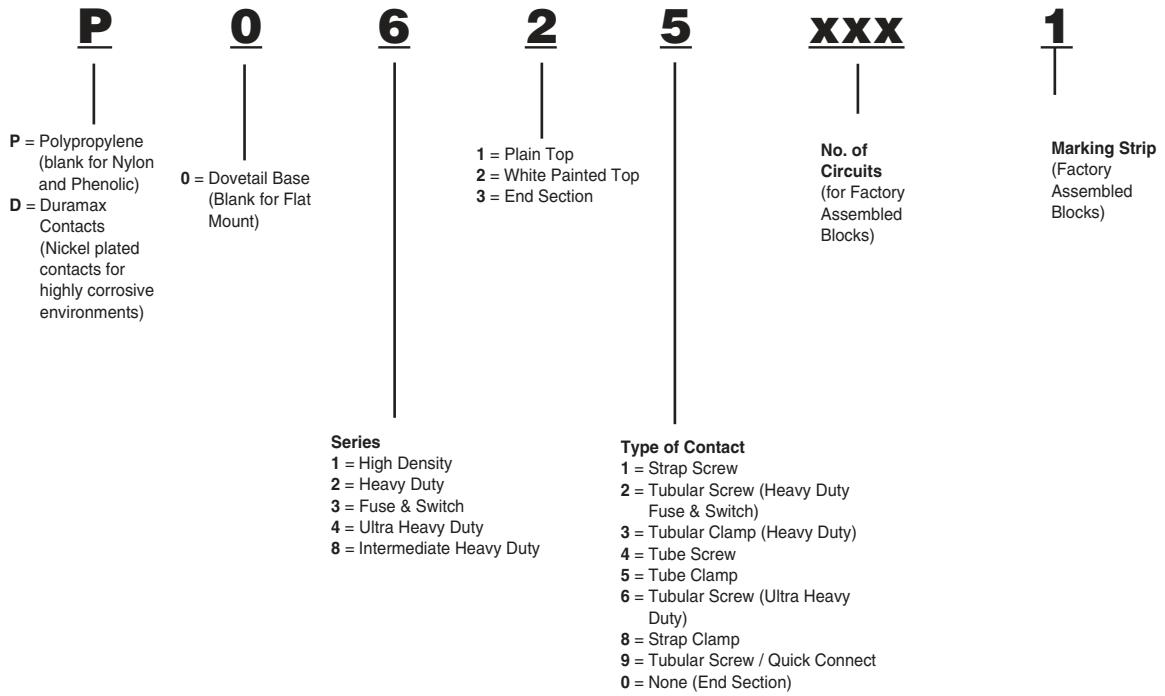

Note: Some catalog number combinations are not valid. Check appropriate catalog pages before ordering.

100 Series High Density Miniature Blocks

Product Facts

- n **No Wire Crimping Required** — tubular clamp contacts hold wire ranging from #30 to #12 AWG better than crimp-on terminals.
- n **Saves Installation Time and Costs** — tubular clamp contacts are supplied with captive screws backed out.
- n **Nylon housing standard; polypropylene for fire retardant characteristics.**
- n **Positive Stop** — helps prevent wire from being inserted too far, and helps prevent screw from being tightened on insulation. Easy access contact provides for safe, reliable, and cost-effective connection.
- n **Quick Installation and Change** — additional sections may be added or removed without removing channel mounting screw.
- n **Choice of Five Mounting Channels:**
 - n Miniature aluminum
 - n Zinc-plated steel
 - n Pre-punched aluminum
 - n Break-away steel
- n **Single and Double Tier blocks fit all standard BUCHANAN mounting channels. Single Tier blocks fit both miniature and standard channels.**
- n **Choice of Marking Surfaces** — matte-finish area for marking directly on block; slide-in vinyl strip (blank or preprinted) also available.

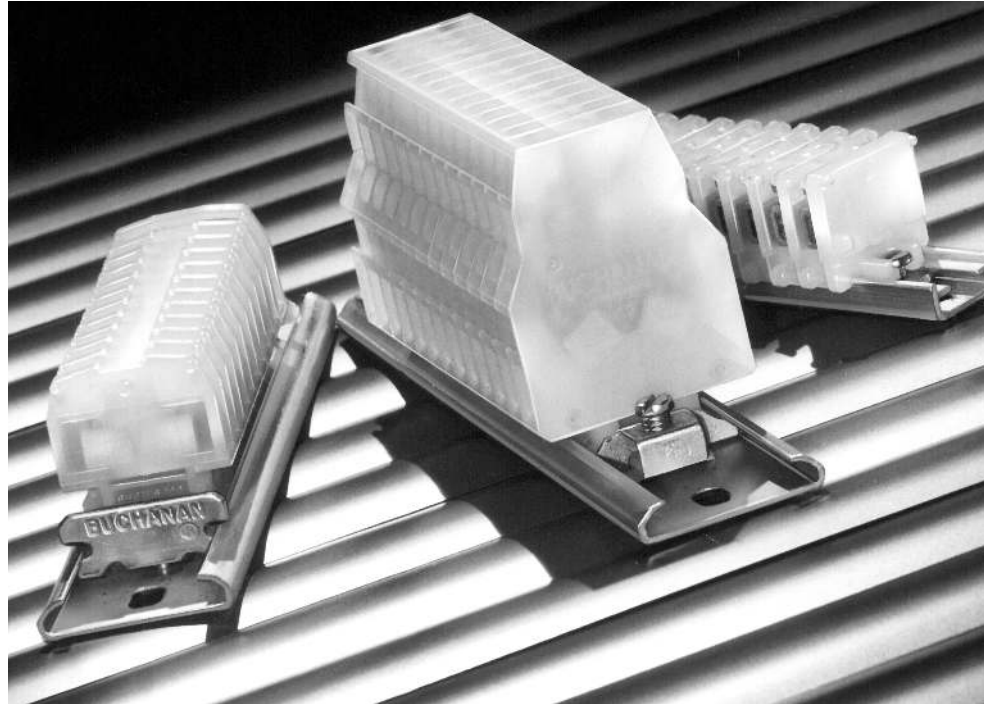

These miniature terminal blocks fit on a much smaller channel to save valuable panel space or can be surface mounted directly to the panel. Miniature blocks accept wire as large as #12 AWG and are available in four styles: Miniature (nylon), Miniature (polypropylene), Single Tier and Double Tier.

100 Series High Density Miniature Blocks

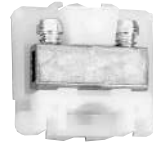

**Miniature
Nylon**



**Miniature
Polypropylene**



Single Tier

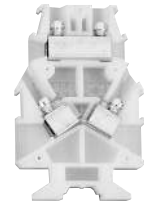

Double Tier

Characteristics

Type of Block	Model	Part Number	Model	Part Number	Model	Part Number	Model	Part Number
Standard Block	125-BU	2-1437392-3	P125	4-1437392-7	115-BU	1437381-5	105-BU	1-1437392-7
Corrosion Resistant (nickel plated contacts)	D125	3-1437389-3	DP125	7-1437389-1	D115	3-1437389-2	D105	2-1437392-9
Specifications								
Housing Material	Nylon	—	Polypropylene	—	Nylon	—	Nylon	—
Max. Service Temperature	125°C (257°F)	—	105°C (221°F)	—	125°C (257°F)	—	125°C (257°F)	—
Flammability	UL94V-2	—	UL94V-0	—	UL94V-2	—	UL94V-2	—
Wire Strip Length (in.)	5/16	—	5/16	—	5/16	—	5/16	—
Torque, in-lbs.	6-9	—	6-9	—	6-9	—	6-9	—
Electrical Characteristics								
UL Rating	20 A @ 300V	—	20 A @ 300V	—	20 A @ 600V	—	20 A @ 600V	—
Wire Range (solid & stranded)	30-12	—	30-12	—	30-12	—	30-12	—
Spacing								
Pitch	0.25"	—	0.25"	—	0.25"	—	0.24"	—
Terminals per Foot	48	—	48	—	48	—	102	—
Accessories								
End Section (gray)	130-BU	2-1437392-5	P130	4-1437392-9	120	2-1437392-1	110-BU	1-1437392-8
Jumper, 2 pole	10	1437381-1	10	1437381-1	10	1437381-1	—	—
Jumper, 10 pole	—	—	—	—	—	—	J10	3-1437392-1
Jumper, Inter-tier	—	—	—	—	—	—	J2-BU	3-1437392-2
Mounting Channel								
Miniature (3ft)	12	1437381-8	12	1437381-8	12	1437381-8	—	—
Steel, Zinc plated (6ft)	—	—	—	—	60	9-1437381-1	60	9-1437381-1
Steel, Zinc plated (3ft)	—	—	—	—	63-BU	9-1437381-8	63-BU	9-1437381-8
Breakaway, steel	—	—	—	—	60B36	9-1437381-2	60B36	9-1437381-2
Pre-punched aluminum (6ft)	—	—	—	—	64	9-1437381-9	64	9-1437381-9
Pre-punched aluminum (3ft)	—	—	—	—	67	1437382-2	67	1437382-2
Channel Clamps								
Miniature (use w/#12 channel)	11	1437381-4	11	1437381-4	11	1437381-4	—	—
Universal	—	—	—	—	68	1437382-3	68	1437382-3

100 Series High Density Miniature Blocks Accessories

Channel Clamps

Marking Accessories



Screw Steel Channel	Universal	Snap-in	Miniature for #12 Channel	See-thru Cover	Ganging Rod	Miniature Vinyl Marking Strips	Elevated Marking Strip	Nylon Holding Plug
Part Number								
9-1437381-5	1437382-3	9-1437381-7	1437381-4	1-1437381-0	1-1437381-1	1-1437381-2	4-1437381-1	1-1437381-3
Catalog Number								
61	68	62	11	13	14	15	52-BU	16
Available For								
Single Tier Double Tier	Single Tier Double Tier	Single Tier Double Tier	Miniature Single Tier	Miniature Single Tier	Miniature Single Tier	Miniature Single Tier Double Tier	Miniature Single Tier Double Tier	Miniature Single Tier
Standard Length								
—	—	—	—	—	2 feet	25 feet	18 inches	—

Factory Assembled Blocks

Description	Direct Mount	Channel Mount
Miniature (nylon)	125xx	0125xx
	D125xx (nickel)	D0125xx (nickel)
Single Tier (nylon)	115xx	0115xx
	D115xx (nickel)	D0115xx (nickel)
Double Tier (nylon)	105xx	0105xx
	D105xx (nickel)	D0105xx (nickel)
Miniature (polypropylene)	P125xx	P0125xx
	DP125xx (nickel)	DP0125xx (nickel)

Note: xx = number of blocks desired. For factory assembled blocks with removable marking strip, add "-1" to Catalog Number. Minimum order quantities may apply.

Related Product Data

Wire Pins and Ferrules—Pages 109-111

For more information on AMP Standard Terminals and Splices or Quick-Connect FASTON Receptacles and Tabs, request Catalog 82042.



Note: All part numbers are RoHS Compliant.

Miniature Blocks

Miniature

$C = .29 [7.37] + (.25 [6.35] \times N)$
 $L = .51 [12.95] + (.25 [6.35] \times N)$

On Miniature Channel:

$C_{CH} = 1.00 [25.4] + (.25 [6.35] \times A)$
 $L_{CH} = 1.35 [34.29] + (.25 [6.35] \times A)$
A = N when N is even
A = N + 1 when N is Odd
N = No. of Miniature Sections

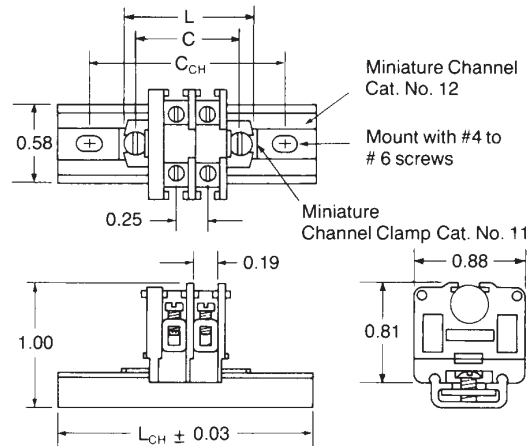

Single Tier

$C = .35 [8.89] + (.25 [6.35] \times N)$
 $L = .50 [12.7] + (.25 [6.35] \times N)$

On Standard Channel:

$C_{CH} = 2.00 [50.8] + (.25 [6.35] \times N)$
 $L_{CH} = 2.75 [69.85] + (.25 [6.35] \times N)$
N = No. of Single Tier Sections

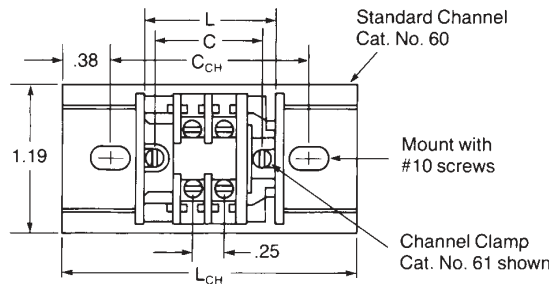

On Miniature Channel:

$C_{CH} = 1.00 [25.4] + (.25 [6.35] \times A)$
 $L_{CH} = 1.35 [34.29] + (.25 [6.35] \times A)$
A = N when N is Even
A = N + 1 when N is Odd
N = No. of Single Tier Sections

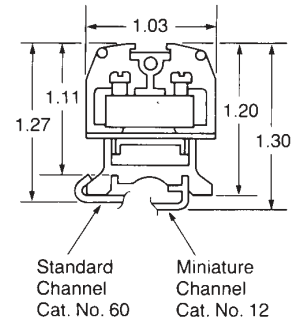
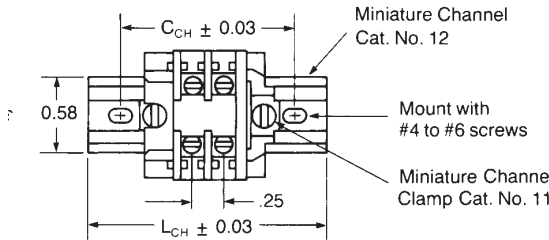

Double Tier

$L = .08 [2.03] + (.24 [6.10] \times N)$

On Miniature Channel:

$C_{CH} = 1.58 [2.03] + (.24 [6.10] \times A)$
 $L_{CH} = 2.33 [59.18] + (.24 [6.10] \times A)$
N = No. of Double Tier Sections

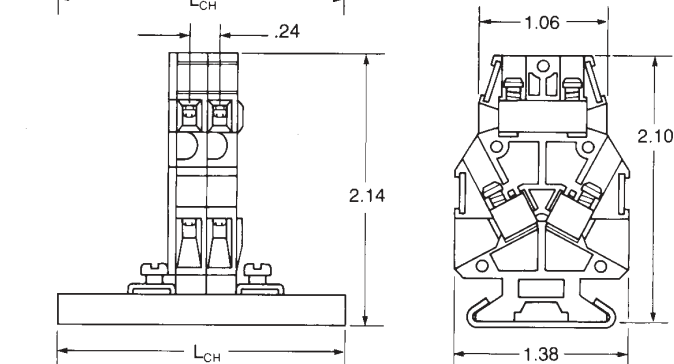
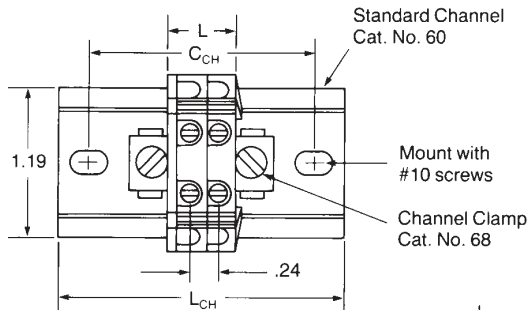

900 Series, Medium Duty

Product Facts

- n High circuit density - 183 circuits per 6-foot length, 3/8 inch pitch.
- n Choice of five contact styles - tubular clamp, tubular screw, strap screw, quick connect and tubular screw quick connect.
- n Sections snap-fit with Heavy Duty, Intermediate Heavy Duty, and Fuse & Switch blocks.
- n Readily identify circuits - mark directly on block sections or use removable marking strip. Preprinted marking strips also available.
- n Rated up to 50 amperes per circuit.
- n Flat base models mount directly to surfaces or on miniature channel. Dovetail base mounts on standard size channel.
- n Packaged for rapid handling and assembly - 100 per carton.
- n Only one end section needed per block assembly.
- n Fanning strips - interlocking sectional fanning strips allow entire circuit groups to be connected and disconnected as a single unit.
- n Factory assembled blocks available, including marking strips and different contact sections.

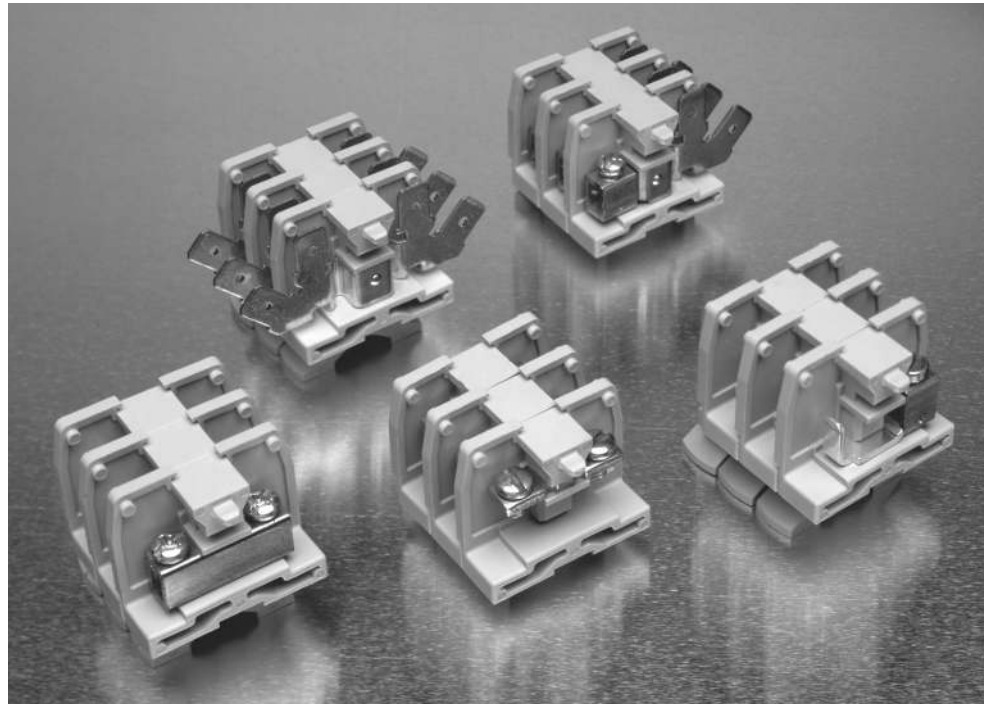

NEMA 900 Series is available in .375" [9.53] centerline, in direct or channel mount, tubular or strap versions, and screw, clamp or quick connect configurations. Corrosion-resistant versions are also available.

NEMA 900 Series snap fit with the Medium Duty 500, 600 and 700 Series, as well as with the Heavy Duty, Intermediate Heavy Duty and Fuse & Switch blocks.

Note: All part numbers are RoHS Compliant.

900 Series, 600V Medium Duty, 0.375" [9.53] Pitch

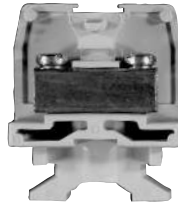

Characteristics

Strap Screw

Tubular Screw

Tubular Clamp

Quick Connect

Type of Block	Model	Part Number	Model	Part Number	Model	Part Number	Model	Part Number
Direct Mount (Flat Base)								
Standard	921	1546143-1	924	1546147-1	925	1546234-1	927	1546149-1
Corrosion Resistant (Duramax)	D921	1546143-2	D924	1546147-2	D925	1546234-2	—	—
Channel Mount (Dovetail Base)								
Standard	0921	1546144-1	0924	1546148-1	0925	1546235-1	0927	1546150-1
(Duramax)	D0921	1546144-2	D0924	1546148-2	D0925	1546235-2	—	—

Contact Type

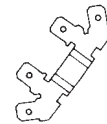

Specifications

Wire Range (AWG) Solid & Stranded	10*, 22-14	22-8	22-8	—
Wire Strip Length (in.)	—	11/32	11/32	—
Screw Type	6-32 Binding Head	10-32 Pan Head	10-32 Slotted Pan Head	—
Ampacity	35 A*, 15A	50 A	30 A	20 A

End Sections

Direct Mount	930	1546163-1	930	1546163-1	930	1546163-1	930	1546163-1
Channel Mount	0930	1546164-1	0930	1546164-1	0930	1546164-1	0930	1546164-1

*Acceptable for 35A max. factory wiring only when used with 10AWG wire preterminated with suitable ring tongue terminals.
Note: Standard package is 100 pieces for contact, 25 pieces for end section.

Comparison (Type of Block)



Direct Mount (Flat Base)



Channel Mount (Dovetail Base)



Note: All part numbers are RoHS Compliant.

900 Series, 600V Medium Duty, 0.375" [9.53] Pitch (Continued)

Independent Testing Service Listing and Recognition

WIRE SIZES, Solid or Stranded
 Tubular Screw
 1 #18 AWG to 1 #8 AWG,
 2 or 3 #12 AWG, 2 to 4 #14 AWG,
 2 or 4 #16 AWG, 2 to 5 #18 AWG,
 Tubular Clamp
 1 #22 AWG to 1 #10 AWG,
 2 #12 AWG, 2 or 3 #14 AWG,
 2 to 4 #16 AWG, 2 to 5 #18 AWG,
 2 to 8 #20 AWG, 2 to 10 #22 AWG,
 Strap Clamp
 1 #22 AWG to 1 #10 AWG



Tubular Screw & Quick Connect



Tubular Clamp with Blade

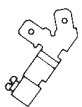
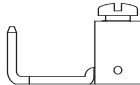

Tubular Clamp with Cantilever

Model	Part Number	Model	Part Number	Model	Part Number
929	1546151-1	—	—	—	—
—	—	—	—	—	—
0929	1546152-1	BP035M	3-1437394-6	BP35F	3-1437394-7
—	—	—	—	—	—
					
18-12		22-10		22-10	
—		11/32		11/32	
—		10-32 Phil-slot		10-32 Phil-slot	
20 A		30 A		30 A	
930	1546163-1	—	—	—	—
0930	1546164-1	0930	1546164-1	—	—



Note: All part numbers are RoHS Compliant.

ERT Series, Medium Duty Radiation Resistant

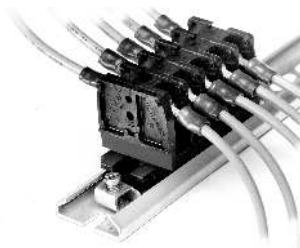

Physical Properties
Effect of Radiation on Physical Properties

The effects of radiation (neutron and gamma particles) on RYTON R-4 material have been studied. Since RYTON, as an engineering plastic, may fill applications in nuclear installations these effects are important. The test results show no effects on physical properties by these relatively high exposures to gamma and neutron radiation. There is no indication from these data of crosslinking or degradation of the RYTON R-4 material.

Note: Determination of the suitability of the ERT Series Blocks for particular applications rests solely with customers.

DOVETAIL BASE MOUNTED ON STANDARD #60 CHANNEL

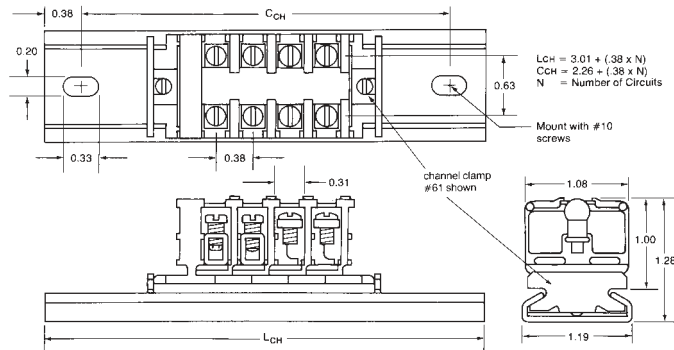

Description	Catalog Number	Part Number
Strap Screw	0721ERT	1437394-9
Tubular Clamp	0725ERT	1-1437394-6
Tubular Screw	0724ERT	1-1437394-1
End Section	0730ERT	2-1437394-0

Housing: RYTON (Polyphenylene Sulfide)		ASTM Test
Density	100 lbs./ft.3	D1505-68
Tensile Strength	19,500 psi	D638-72
Elongation	1.3%	D638-72
Flexural Modulus	1,700,000 psi	D790-91
Flexural Strength	29,000 psi	D790-91
Compressive Strength	21,000 psi	D695-69
Izod Impact Strength		
Unnotched, 1/8" Specimen	8.0 ft. lbs./in.	
Notched, 1/8" Specimen	1.4 ft. lbs./in.	
Rockwell Hardness	R-123	D785-65
Water Absorption	0.05%	D570-63
Heat Distortion Temp. @ 264 psi	500°F	D648-72
Specific Heat, 24 hrs. @ 25°C	0.25 btu/lb./°F	
Thermal Conductivity	2.0 btu-in./h-ft.2 F	
Coefficient/Linear Thermal Exp.	2.5 x 10-5 in./in./°F	
Flammability, UL 94	V-0	
Dielectric Strength	350 volts/mil	D149-64
Dielectric Constant, 25°C 1 kHz	3.9	D150-70
1MHz	3.8	
Dissipation Factor, 25°C 1kHz	0.0010	D150-70
1MHz	0.0013	
Conditions		
Temperature	In Reactor Core 35°C	In Water Pool 30°C
Radiation	Mainly neutrons	Mainly gamma
Intensity	1010 ergs g-1 (C)	109 ergs g-1 (C)
Used Particle Detectors	Calorimeter and activation detectors	Ionization chamber
Radiation Dose		
	Flexural Strength psi	Modulus of Elasticity, psi
0	28,700	1,900,000
A. Neutron		
5 x 10 rad	29,000	1,910,000
1 x 10 rad	28,900	1,880,000
B. Gamma		
5 x 10 rad	29,700	1,810,000
1 x 10 rad	30,200	1,840,000
5 x 10 rad	28,500	1,820,000

RYTON is a registered trademark of Chevron Phillips Chemical Company.



Medium Duty Accessories

Mounting Channel

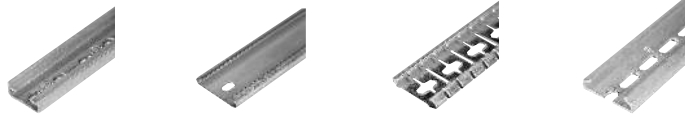

Miniature		Steel Channel		Break Away Steel		Pre-punched Aluminum Channel	
Part Number	Catalog Number	Part Number	Catalog Number	Part Number	Catalog Number	Part Number	Catalog Number
1437381-8	12	9-1437381-1 9-1437381-8	60 63-BU	9-1437381-2	60-B-36	9-1437381-9 1437382-2	64 67
Standard Length							
3 feet		6 feet 3 feet		3 feet		6 feet 3 feet	

Channel Clamps



Screw Channel Clamps	Universal Clamps	Snap-In Clamps	Miniature for #12 Channel	See-thru Cover	Ganging Rod	Polarizing Plug
Part Number	Part Number	Part Number	Part Number	Part Number	Part Number	Part Number
9-1437381-5	1437382-3	9-1437381-7	1437381-4	1-1437382-2	3-1437381-9	2-1437382-5
Catalog Number	Catalog Number	Catalog Number	Catalog Number	Catalog Number	Catalog Number	Catalog Number
61	68	62	11	71	30-BU	84
Standard Length						
—						2 feet

Jumpers



Jumper for tubular Contacts	Snap-apart for Tubular Contacts
Part Number	Part Number
1437382-6	1-1437382-3
Catalog Number	Catalog Number
70	73

Related Product Data

Wire Pins and Ferrules—Pages 109-111
For more information on AMP Standard Terminals and Splices or Quick-Connect FASTON Receptacles and Tabs, request Catalog 82042.

Note: All part numbers are RoHS Compliant.

Medium Duty Accessories (Continued)

Marking Accessories



Plastic Cloth Tape	Plastic Cloth Tape	Vinyl Marking Strips	Elevated Marking Strip	Nylon Holding Plug
Part Number				
1437382-1	8-1437381-0	6-1437381-3	4-1437391-1	4-1437393-0
Catalog Number				
66	55-BU	50-BU	52-BU	65-BU
Standard Length				
—	50 feet	25 feet	18 inches	—

Sectional Fanning Strips



Strap Screw

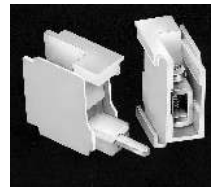

Tubular Screw

Description	Standard Package	Part No.	Catalog No.
Tubular Screw	50	1-1437382-4	74
Strap Screw	50	1-1437382-7	78-TB
Molding Only, no contact	50	4-1437393-1	74100

Note: All part numbers are RoHS Compliant.

Medium Duty Channel Mount

Dovetail Base Mounted On Standard #60 Channel

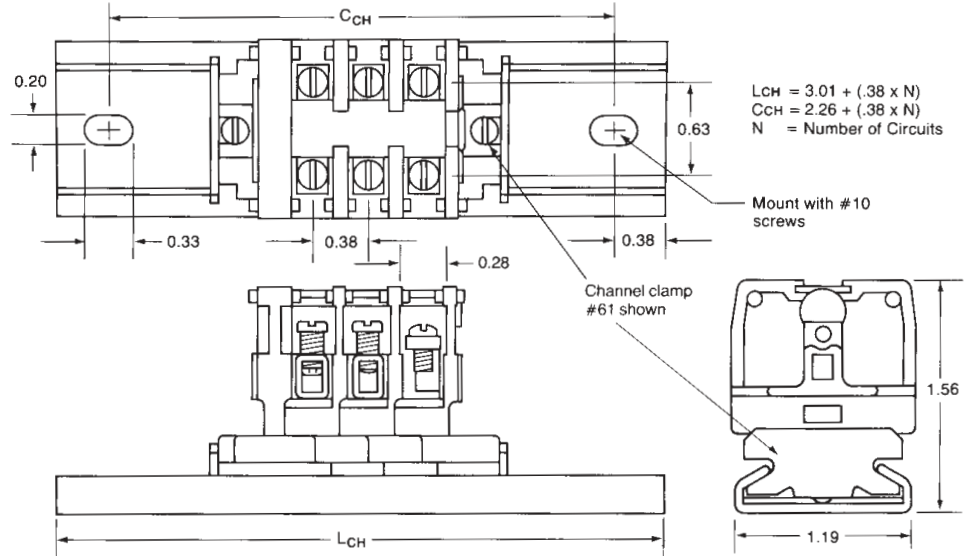

Flat Base Mounted On Miniature #12 Channel

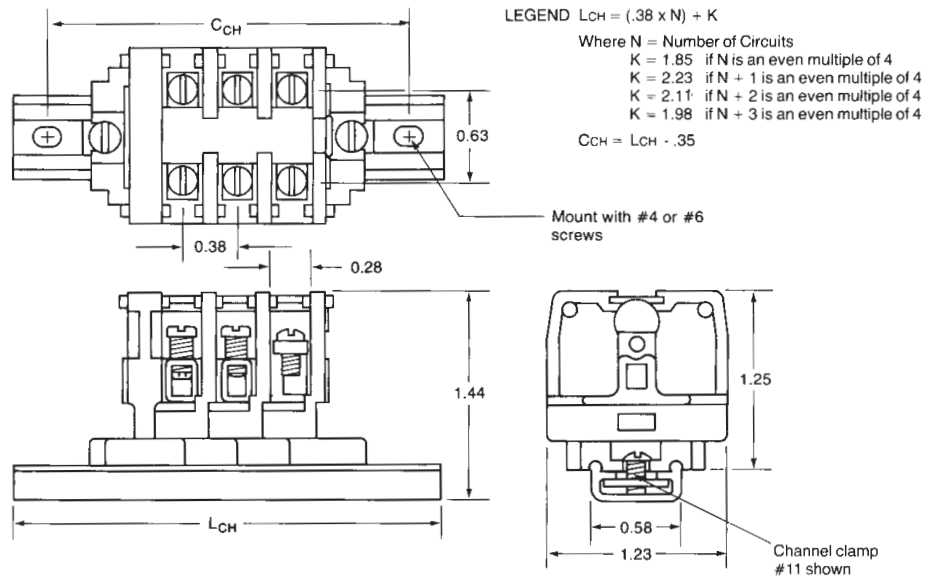

Note: All part numbers are RoHS Compliant.

900 Series, Flat Base

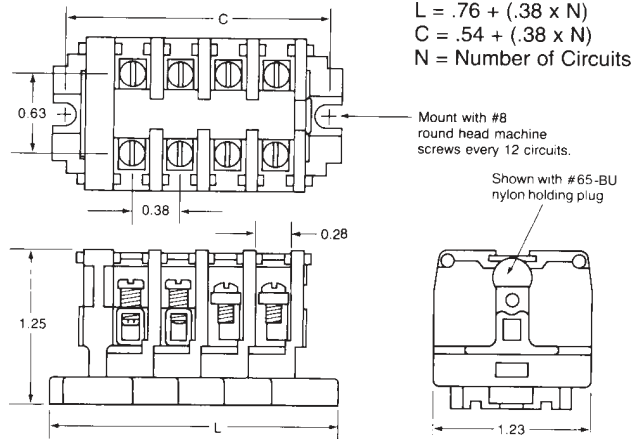
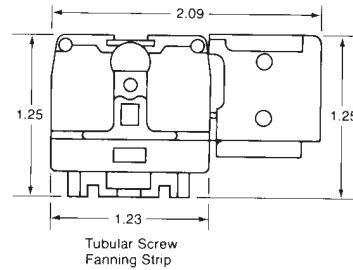
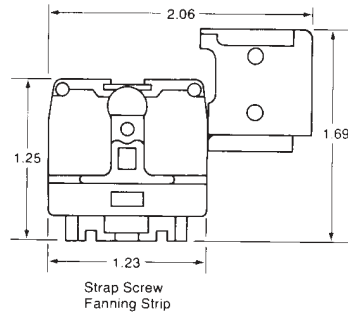

Note: All part numbers are RoHS Compliant.

BP Series, Plug-in Blocks

Dovetail Base Mounted On Standard #60 Channel

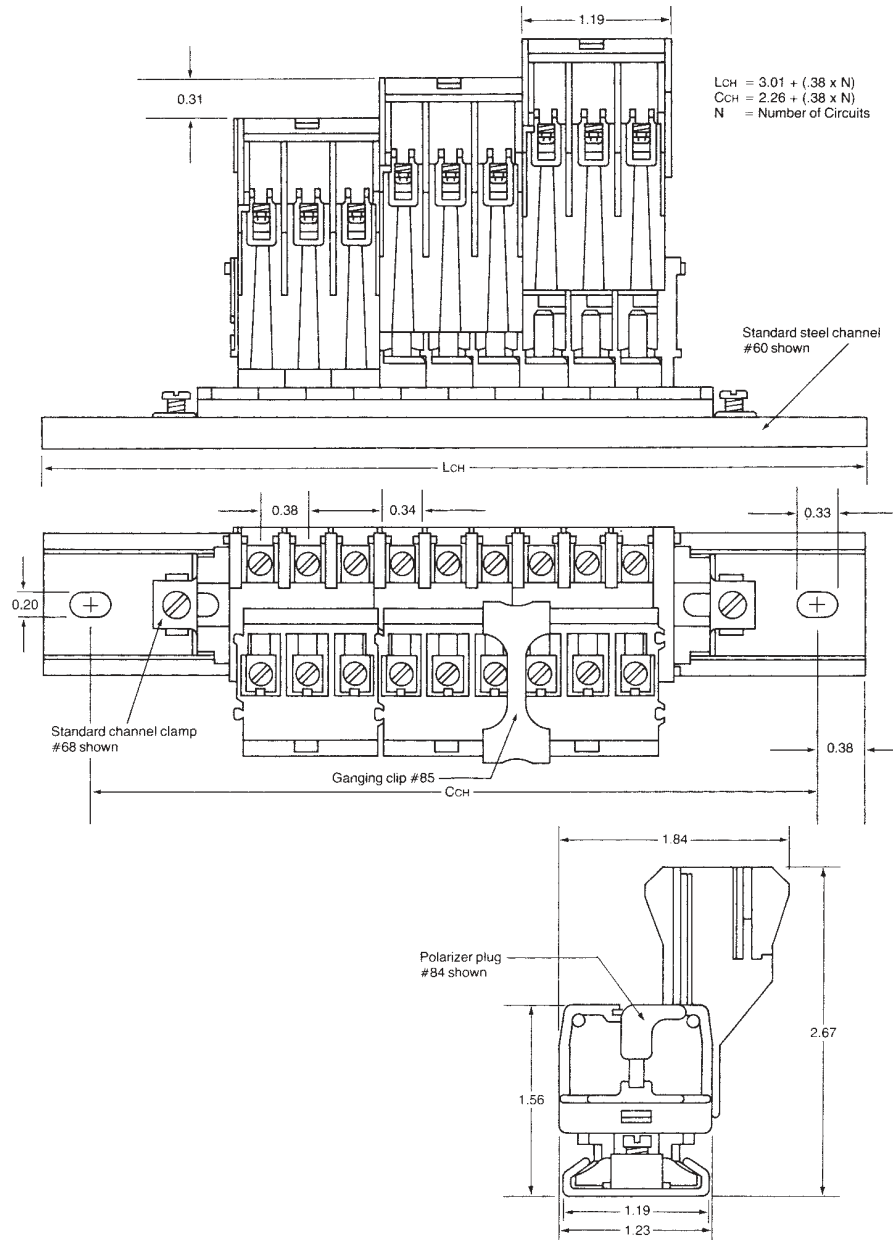

NEMA Terminal Blocks **6**

Note: All part numbers
are RoHS Compliant.

Engineering Notes



200 Series Heavy Duty

Product Facts

- n Choose from 5 different contact styles.
- n 600 volt UL and NEMA rating.
- n Conservatively rated from 50 to 90 amperes per circuit, depending on which contact style is selected.
- n Choose any of three mounting methods — two-way flat base models surface mount directly to the panel or snap-on miniature channel. Dovetail base models mount on standard channel.
- n Packaged for rapid handling and assembly — snap-fit sections are packed 10 per carton.
- n Only one end section needed per block assembly.
- n Readily identify circuits — mark directly on block sections or use removable marking strip. Pre-printed strips are also available.

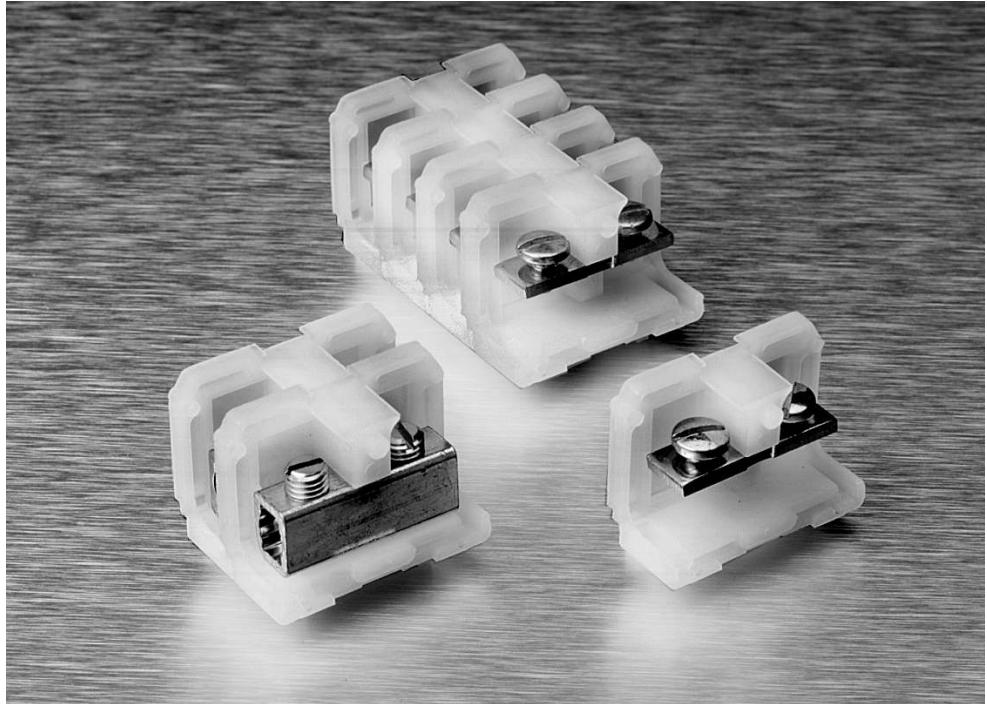

This compact, heavy duty block line accepts single or combination wires up to #4 AWG, solid or stranded. The compact design allows at least 138 circuits per 6-foot length to be mounted. The pitch of this 600 volt block is 0.50" [12.70] (centerline spacing).

Note: All part numbers are RoHS Compliant.

200 Series, Heavy Duty, 600V, 0.50" [1.27] Pitch



Characteristics **Strap Screw** **Strap Clamp** **Tubular Screw** **Tubular Clamp**

Type of Block	Model	Part Number	Model	Part Number	Model	Part Number	Model	Part Number
Direct Mount (Flat Base)								
Nylon, Unpainted	241	3-1437390-9	248	4-1437390-2	242	4-1437390-0	243	4-1437390-1
Polypropylene	P241	6-1437390-5	P248	6-1437390-8	P242	6-1437390-6	P243	6-1437390-7
Channel Mount (Dovetail Base)								
Nylon, Painted	0241	1-1437390-6	0248	2-1437390-4	0242	2-1437390-0	0243	2-1437390-1
Polypropylene	P0241	5-1437390-9	P0248	6-1437390-3	P0242	6-1437390-0	P0243-BU	6-1437390-2

Contact Type



Specifications

Wire Range (AWG) Solid & Stranded	22-10	18-8	18-4	18-6
Wire Strip Length (in.)	—	1/2	1/2	1/2
Screw Type	10-32 binding head	8-32 pan head	1/4-28 set screw	1/4-28 set screw
Ampacity	35 A	50 A	85 A	65 A

End Sections

Direct Mount, Nylon	250	4-1437390-3	250	4-1437390-3	250	4-1437390-3	250	4-1437390-3
Direct Mount, Polypropylene	P250	6-1437390-6	P250	6-1437390-6	P250	6-1437390-6	P250	6-1437390-6
Channel Mount, Nylon	0250	2-1437390-5	0250	2-1437390-5	0250	2-1437390-5	0250	2-1437390-5
Channel Mount, Polypropylene	P0250	6-1437390-4	P0250	6-1437390-4	P0250	6-1437390-4	P0250	6-1437390-4

Notes:

For factory assembled blocks, suffix Catalog Number with number of blocks desired. See page 264-266 for dimensions and other details. (Maximum number of flat base preassembled sections is 12). Example: Ten tubular clamp, dovetail based sections, preassembled on channel = 024310

Example: Twelve polypropylene strap clamp flat base sections = P24812

For unpainted factory assembled blocks supplied with a removable marking strip add — 1 to Catalog Number.

For blocks with two or more different contact sections, imprinted marking strips, or special features, consult Technical Support.

Comparison (Type of Block)



**Direct Mount
(Flat Base)**



**Channel Mount
(Dovetail Base)**



Note: All part numbers are RoHS Compliant.

200 Series, Heavy Duty, 600V, 0.50" [1.27] Pitch (Continued)





Corrosion Resistant Strap Screw



Corrosion Resistant Tubular Screw

Model	Part Number	Model	Part Number
D241	4-1437389-0	D242	4-1437389-1
DP241	1776721-1	DP242	1776723-1
D0241	1776722-1	D0242	1776724-1
DP0241	6-1437389-0	DP0242	1776724-2

	
22-10	18-4
—	1/2
10-32 Nickel plated binding head	1/4-28 Nickel plated set screw
35 A	85 A

250	4-1437390-3	250	4-1437390-3
P250	6-1437390-6	P250	6-1437390-6
O250	2-1437390-5	O250	2-1437390-5
P0250	6-1437390-4	P0250	6-1437390-4



Note: All part numbers are RoHS Compliant.

200 Series Heavy Duty Accessories

Mounting Channel



Miniature		Steel Channel		Break Away Steel		Pre-punched Aluminum Channel	
Part Number	Catalog Number	Part Number	Catalog Number	Part Number	Catalog Number	Part Number	Catalog Number
1437381-8	12	9-1437381-1 9-1437381-8	60 63-BU	9-1437381-2	60-B-36	9-1437381-9 1437382-2	64 67
Standard Length							
3 feet		6 feet 3 feet		3 feet		6 feet 3 feet	

Channel Clamps



Screw Channel Clamps	Universal Clamps	Snap-In Clamps	Miniature for #12 Channel	See-thru Cover	Ganging Rod
Part Number					
9-1437381-5	1437382-3	9-1437381-7	1437381-4	1-1437381-6	3-1437381-9
Catalog Number					
61	68	62	11	23-BU	30-BU
Standard Length					
—	—	—	—	—	2 feet

Marking Accessories



Jumpers



Plastic Cloth Tape	Plastic Cloth Tape	Vinyl Marking Strips	Elevated Marking Strip	Nylon Holding Plug	Jumper for Tubular Contacts	Snap-Apart for Tubular Contacts
Part Number						
8-1437381-1	8-1437381-0	6-1437381-3	4-1437391-1	4-1437393-0	2-1437393-4	1-1437382-5
Catalog Number						
56	55-BU	50-BU	52-BU	65-BU	42-BU	75
Standard Length						
—	50 feet	25 feet	18 inches	—	—	12 ckt

Related Product Data

Wire Pins and Ferrules—Pages 109-111
For more information on AMP Standard Terminals and Splices or Quick-Connect FASTON Receptacles and Tabs, request Catalog 82042.



Note: All part numbers are RoHS Compliant.

200 Series Heavy Duty Specifications

Material & Finish

Voltage Rating: Blocks meet 600 volt creepage and clearance requirements of NEMA, UL and CSA for general industrial control equipment and panelboards. Withstand voltages greatly in excess of IEEE switchgear standards for 750 volts.

Ampacity: For a single #4 AWG wire the maximum amperage recommended is 85 amps.

Standard Contacts:

Material: Electrical grade copper or copper alloy conductor. Steel Screws plated to resist corrosion in most industrial applications

AL-CU Tubular Screw: Aluminum compatibility with aluminum or copper conductors. AL-CU is tin-plated brass.

Environmental Contacts (for highly corrosive atmospheres)

Tubular Screw: Electrical grade copper tube with nickel plating. Nickel plated brass screws.

Strap Screw: Nickel plated brass straps and screws. Nickel plating exceeds specification QQ-N-290 Class I, Type VII.

Nylon Housing:

Material—Nylon; Unfilled Type 6/6

Max. Continuous Temperature—125°C [257°F]

Breakdown Voltage (AC, 60 Hz)—

Contact-to-Contact: 7000V

Contact-to-Ground: 7800V

Dielectric Strength (RH 40% at Sea Level)—470-385 Volts/mil thickness Per ASTM D149

UL High Voltage Arc Tracking (inches/min.)—.01-.35

Water Absorption (24 hrs. % wt. gain)—1.5%

Flammability—UL94V-2

Chemical Resistance—Resistant to aromatic hydrocarbons, strong alkalis Per ASTM D543

Radiation Resistance (ergs g-1 (C)—8 x 10⁷

Color—Translucent White

Independent Testing Service Listing and Recognition

WIRE SIZES, Solid or Stranded

Tubular Screw

1 #4 AWG, 1 #6 AWG,

1 or 2 #8 AWG, 1 to 4 #10 AWG,

1 or 5 #12 AWG, 1 to 4 #14 AWG,

1 or 6 #16 AWG, 1 to 8 #18 AWG,

Tubular Clamp

1 #6 AWG, 1 or 2 #8 AWG,

1 to 3 #10 AWG, 1 to 4 #12 AWG,

1 or 4 #14 AWG, 1 to 6 #16 AWG,

1 or 8 #18 AWG

Strap Clamp

1 #18 to 1 #8 AWG

Polypropylene Housing:

Material—Polypropylene; Filled self-extinguishing

Max. Continuous Temperature—105°C (221°F)

Breakdown Voltage (AC, 60Hz)—

Contact-to-Ground: 7800V

Contact-to-Contact: 7000V

Dielectric Strength (RH 40% at Sea Level)—500 Volts/mil thickness Per ASTM D149

UL High Voltage Arc Tracking (inches/min.)—Did not Track

Water Absorption (24 hrs. % wt. gain)—0.02% Per ASTM D570

Flammability—UL94V-0

Chemical Resistance—Resistant to most acids, alkalines, and saline solutions. Also resistant to higher aliphatic solvents and polar substances per ASTM D543

Radiation Resistance (ergs g-1 (C)—No data Available

Color—Opaque White



LR25557



E63810

Note: All part numbers are RoHS Compliant.

200 Series, 600 Volt, Direct Mount

Flat Base

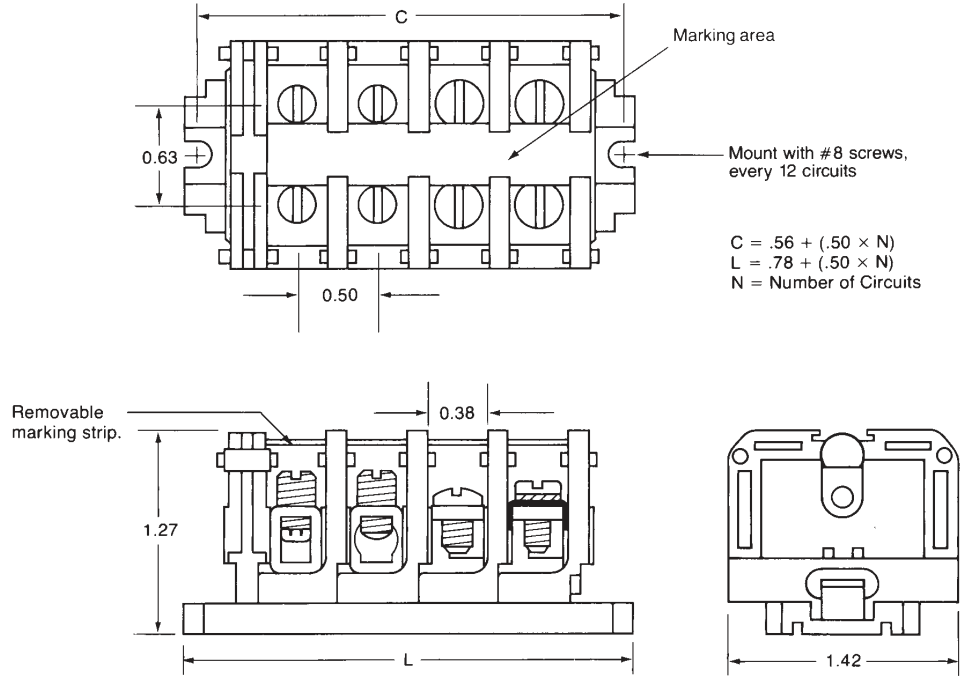

Note: All part numbers are RoHS Compliant.

200 Series, 600 Volt, Channel Mount

Flat Base Mounted On #12 Miniature Channel

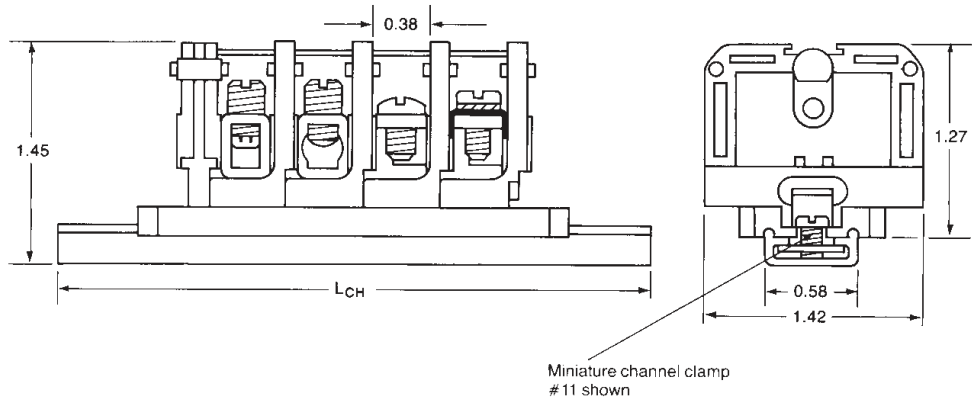
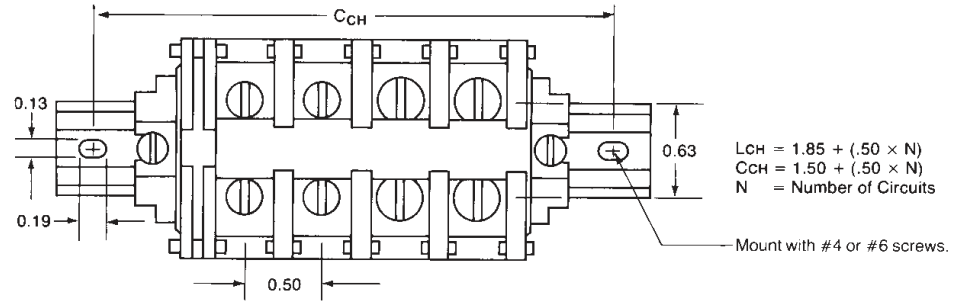

NEMA Terminal Blocks **6**

Note: All part numbers are RoHS Compliant.

200 Series, 600 Volt, Channel Mount (Standard)

Dovetail Base Mounted On Standard #60 Channel

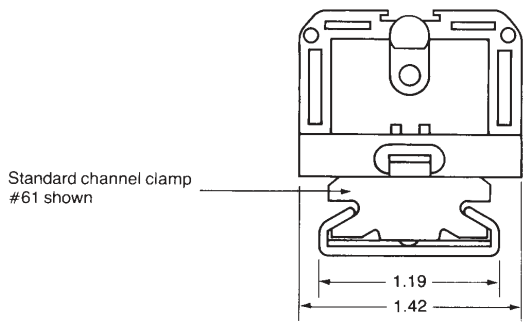
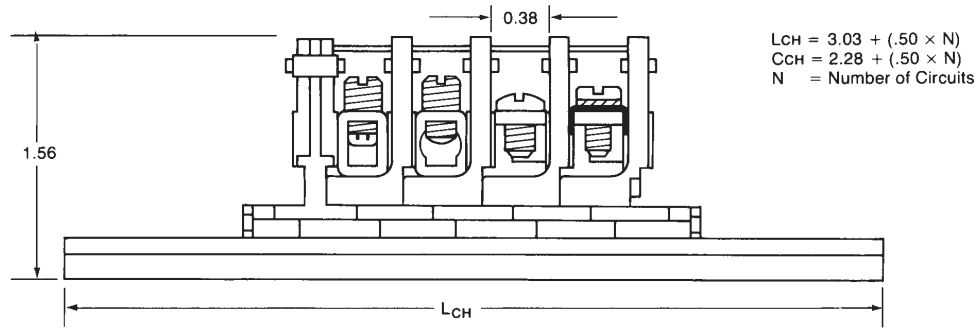
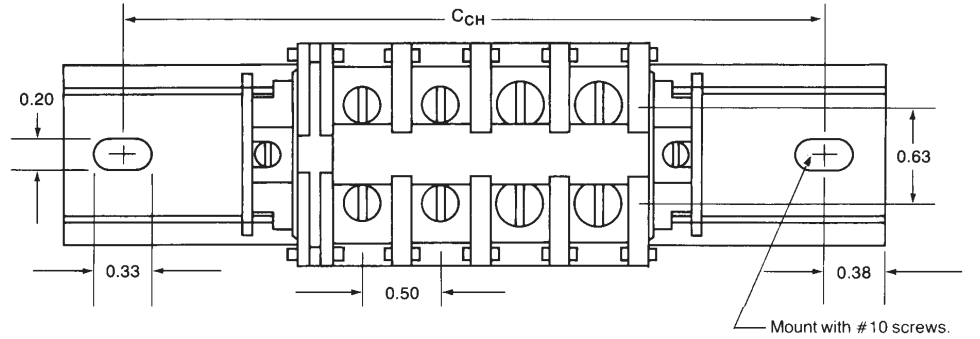

200 Series, Heavy Duty Phenolic Blocks

Product Facts

- n **Sturdy Heavy Duty block accepts single or combinations of wire up to #4 AWG solid or stranded — at least 122 circuits per 6-foot length, 9/16" center-to-center spacing.**
- n **Choose from four different contact styles conservatively rated up to 90 amperes.**
- n **600 volt UL and NEMA rating.**
- n **Surface mounted flat base and channel mounted dovetail base models available.**
- n **Only one end section needed per block assembly.**
- n **Interlocking sectional fanning strips allow entire circuit groups to be connected and disconnected as a single unit.**
- n **Readily identify circuits — available with painted marking surface or use removable marking strip. Pre-printed strips are also available.**
- n **Factory assembled blocks available.**
- n **Heavy Duty Phenolic Block Sections Snap-fit with 300 & 600 volt, medium duty phenolic, heavy duty nylon and polypropylene, and Fuse and Switch blocks.**

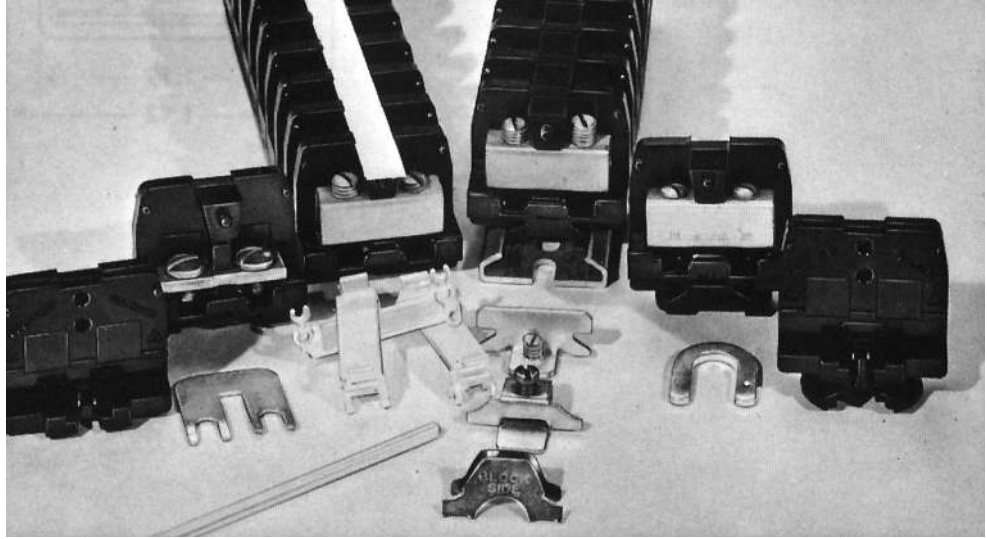

This family of phenolic heavy duty blocks is ideal for high temperature, high current applications. The rugged material withstands temperatures up to 302°F [150°C].

Note: All part numbers are RoHS Compliant.

200 Series, Heavy Duty Phenolic, 600 V, 0.56" [14.24] Pitch



Characteristics

Strap Screw

Strap Clamp

Tubular Screw

Tubular Clamp

Type of Block	Model	Part Number	Model	Part Number	Model	Part Number	Model	Part Number
Direct Mount (Flat Base)								
Painted	221	3-1437390-1	228-BU	1-1437381-5	222-BU	3-1437390-3	223-BU	3-1437390-6
Unpainted	211	2-1437390-7	218	3-1437390-0	212	2-1437390-8	213	2-1437390-9
Channel Mount (Dovetail Base)								
Painted	0221	1437390-8	0228	1-1437390-3	0222	1437390-9	0223	1-1437390-2
Unpainted	0211	1437390-1	0218	1437390-7	0212	1437390-3	0213	1437390-5
Contact Type								



Specifications

Wire Range (AWG) Solid & Stranded	22-10	18-8	18-4	18-6
Wire Strip Length (in.)	—	1/2	1/2	1/2
Screw Type	10-32 binding head	8-32 pan head w/clamp	1/4-28 set screw	1/4-28 set screw
Ampacity	35 A	50 A	85 A	65 A
End Sections				
Direct Mount	230-BU 1-1437381-7	230-BU 1-1437381-7	230-BU 1-1437381-7	230-BU 1-1437381-7
Channel Mount	0230 1-1437390-4	0230 1-1437390-4	0230 1-1437390-4	0230 1-1437390-4

Notes:

For factory assembled blocks, suffix Catalog Number with number of blocks desired. See page 272 for dimensions and other details. (Maximum number of flat base preassembled sections is 12).

Example: Twenty dovetail based, tubular clamp blocks, preassembled on channel = 021320 (plain marking area)

Example: Twelve preassembled flat base, strap screw blocks = 22112 (painted marking area)

For factory assembled blocks supplied with a removable marking strip add — 1 to Catalog Number.

For blocks with two or more different contact sections, imprinted marking strips, or special features, consult Technical Support.

Environmental contacts for highly corrosive atmospheres are available with nickel plating on non-ferrous hardware. To order, prefix Catalog # with "D".

Comparison (Type of Block)



Direct Mount (Flat Base)



Channel Mount (Dovetail Base)



200 Series, Heavy Duty Phenolic, 600 V, 0.56" [14.24] Pitch (Continued)



Corrosion Resistant Strap Screw



Corrosion Resistant Tubular Screw



Corrosion Resistant Tubular Clamp

Model	Part Number	Model	Part Number	Model	Part Number
D221	3-1437389-6	D222	3-1437389-8	D223	3-1437389-9
D211	3-1437389-4	D212	3-1437389-5	D213	4-1437390-6
D0221	1437389-7	D0222	1437389-8	D0223	1437389-9
D0211	1437389-2	D0212	1437389-4	D0213	1437389-6

Contact Type



Specifications

22-10	18-4	22-10
—	1/2	1/2
10-32 Nickel plated binding head	1/4-28 Nickel plated set screw	1/4-28 Nickel plated set screw
35 A	85 A	65 A
230-BU 1-1437381-7	230-BU 1-1437381-7	230-BU 1-1437381-7
0230 1-1437390-4	0230 1-1437390-4	0230 1-1437390-4

Sectional Fanning Strips

Description	Part No.	Catalog No.
Tubular Screw	1-1437381-8	24
Strap Screw	1-1437381-9	27
Molding Only, no contact	1447889-1	2400

Note:

For factory assembled fanning strips, suffix Catalog Number with number desired.

Example: Ten factory assembled sections of #24 = 2410

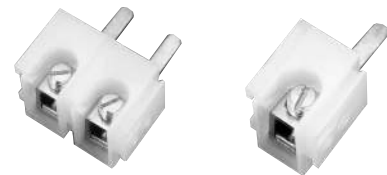

Note: All part numbers are RoHS Compliant.

200 Series, Heavy Duty Phenolic Accessories

Mounting Channel

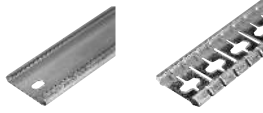

Channel Clamps



Steel Channel	Break Away Steel	Pre-punched Aluminum Channel	Screw Channel Clamps	Universal Clamps	Snap-In Clamps	See-thru Cover	Ganging Rod
Part Number							
9-1437381-1 9-1437381-8	9-1437381-2	9-1437381-9 1437382-2	9-1437381-5	1437382-3	9-1437381-7	1-1437382-2	3-1437381-9
Catalog Number							
60 63-BU	60-B-36	64 67	61	68	62	23-BU	30-BU
Standard Length							
6 feet 3 feet	3 feet	6 feet 3 feet	—	—	—	—	2 feet

Marking Accessories



Jumpers



Plastic Cloth Tape	Plastic Cloth Tape	Vinyl Marking Strips	Elevated Marking Strip	Nylon Holding Plug	Jumper for Tubular Contacts	Jumper for Strap Screw
Part Number						
8-1437381-1	8-1437381-0	6-1437381-3	4-1437391-1	4-1437393-0	2-1437393-3	5-1437381-5
Catalog Number						
56	55-BU	50-BU	52-BU	65-BU	41-BU	43
Standard Length						
10 sheets	50 feet	25 feet	18 inches	—	—	—

Related Product Data

Wire Pins and Ferrules—Pages 109-111
For more information on AMP Standard Terminals and Splices or Quick-Connect FASTON Receptacles and Tabs, request Catalog 82042.

200 Series, Heavy Duty Phenolic Specifications

Material & Finish

Standard Contacts

Material: Electrical grade copper or copper alloy conductor. Steel Screws plated to resist corrosion in most industrial applications.

Environmental Contacts (for highly corrosive atmospheres)

Tubular Screw: - Electrical grade copper tube with nickel plating.

Nickel plated brass screws.

Strap Screw: - Nickel plated brass straps and screws

Nickel plating exceeds specification QQ-N-290 Class I, Type VII.

Wire Range: Strap Screw: #22-10 AWG max., solid or stranded with crimp terminals

Strap Clamp: #18-8 AWG, solid or stranded

Tubular Screw: #18-4 AWG, solid or stranded

Tubular Clamp: #18-6 AWG, solid or stranded

Wire Strip Length: Strap Screw: As needed for lugging

Strap Clamp: 1/2 in. [12.7]

Tubular Screw: 1/2 in. [12.7]

Tubular Clamp: 1/2 in. [12.7]

Screw Type: Strap Screw: 10-32 slotted binding head

Strap Clamp: 8-32 pan head w/ clamp

Tubular Screw: 1/4-28 slotted headless

Tubular Clamp: 1/4-28 slotted headless

Strap Screw: Maximum width of lugs: 11/32 in. [8.73]

Independent Testing Service Listing and Recognition

WIRE SIZES, Solid or Stranded Tubular Screw

Tubular Screw

1 #4 AWG, 1 #6 AWG,

1 or 2 #8 AWG, 1 to 4 #10 AWG,

1 or 5 #12 AWG, 1 to 6 #14 AWG,

1 or 6 #16 AWG, 1 to 8 #18 AWG,

Tubular Clamp

1 #6 AWG, 1 or 2 #8 AWG,

1 to 3 #10 AWG, 1 to 4 #12 AWG,

1 or 4 #14 AWG, 1 to 6 #16 AWG,

1 or 8 #18 AWG

Strap Clamp

1 #18 to 1 #8 AWG

Nylon Housing

Material—Phenolic, Filled Flame Retardant

Max. Continuous Temperature—150°C, [302°F]

Breakdown Voltage—

Contact-to-Contact: 7800V

Contact-to-Ground: 9400V

Dielectric Strength (RH 40% at Sea Level)—300 Volts/mil thickness per ASTM #D149

UL High Voltage Arc Tracking (Inches/min.)—.49-.58 [12.45-14.73]

Water Absorption (24 hrs. % wt. gain)—0.45% per ASTM D570

Flammability—UL94V-1

Chemical Resistance—Resistant to acids, alkalis, and aliphatic hydrocarbons and ketones, per ASTM D543.

Radiation Resistance (ergs g-1 (C))—2.7 x 108 min.

Color—Black



LR25557



E63810

Note: All part numbers are RoHS Compliant.

200 Series, Heavy Duty Phenolic

Flat Base

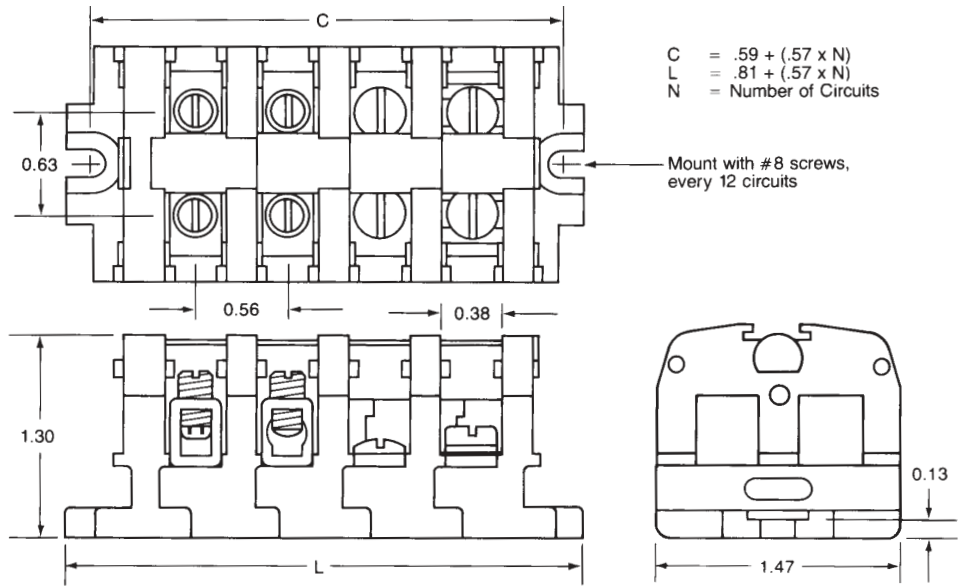

Dovetail Base Mounted On Standard #60 Channel

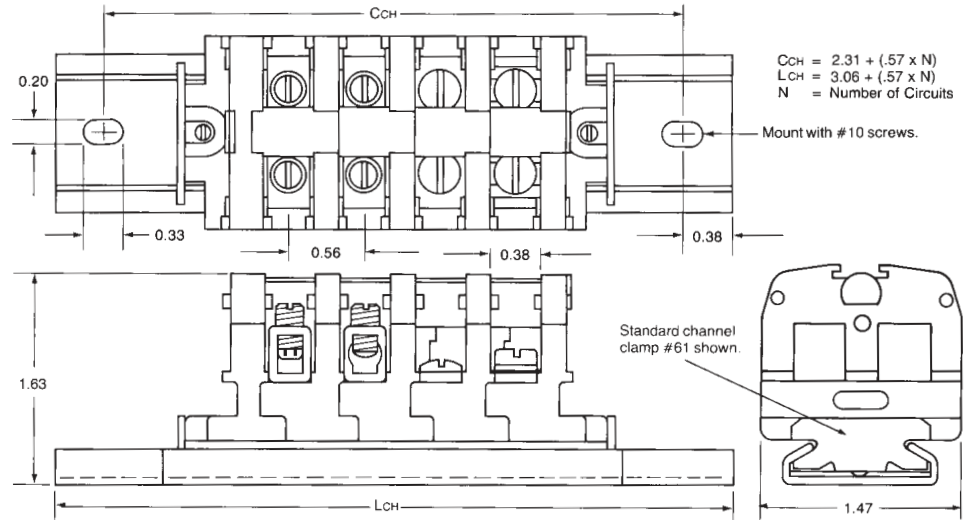

Sectional Fanning Strips

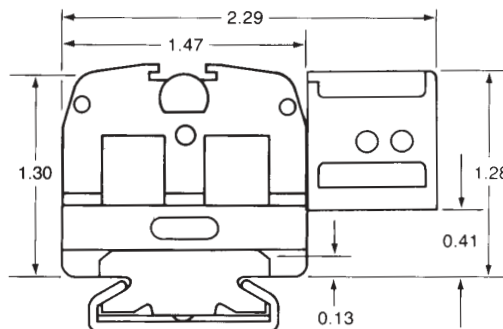

800 Series, Intermediate Heavy Duty

Product Facts

- n An exceptionally compact block that accepts single or combinations of AWG wire sizes as large as #1/0 — at least 92 circuits per 6-foot length, 3/4 inch center-to-center spacing.
- n Tubular screw contact style accepts AWG wire sizes from #12 thru #1/0, solid or stranded.
- n Same block mounts on surface or channel — two-way mounting base fits standard channel or mounts directly to flat surfaces.
- n Packaged for rapid handling and assembly — snap-fit sections packaged 10 per carton.
- n Contacts conservatively rated at 155 amperes per circuit when used with copper wire.
- n Only one end section needed per block assembly.
- n Readily identify circuits — blocks available with painted marking surface or use removable vinyl marking strip. Preprinted marking strips are also available.
- n Factory assembled blocks available.
- n Nylon housing material for the most rugged applications.
- n Allen head screw for aluminum wire — screw tip design helps protect aluminum wire from overtightening. Slotted screw head for copper wire.
- n Intermediate Heavy Duty blocks snap-fit with 300 & 600V, Medium Duty phenolic, Heavy Duty nylon, polypropylene and phenolic and Fuse and Switch blocks.

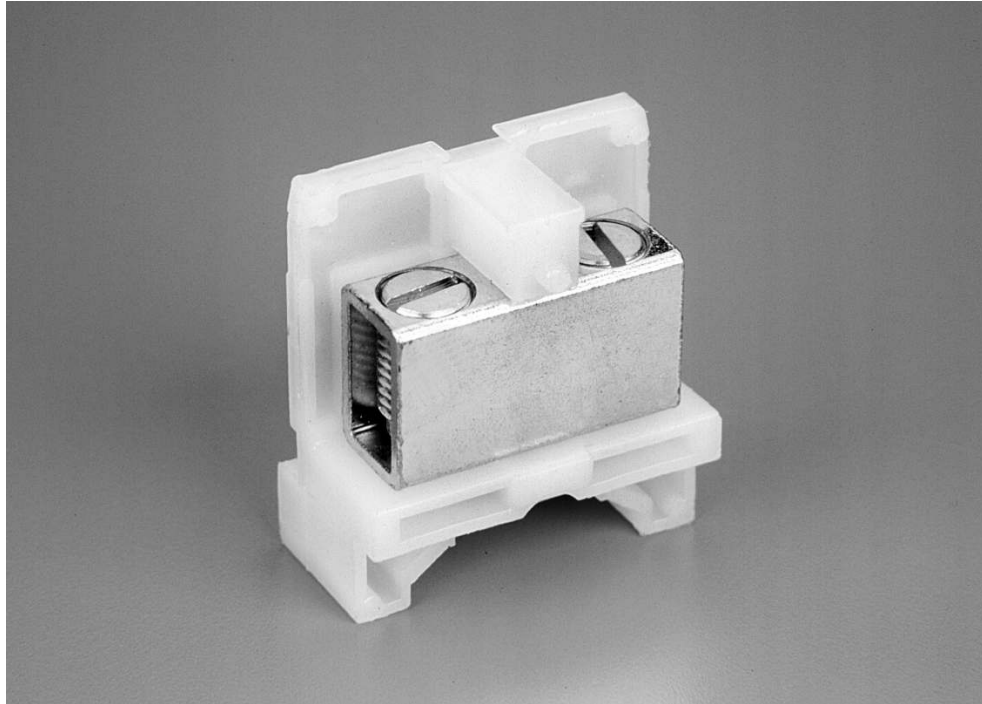

This line of 600 volt blocks is rated up to 150 A and is available in a standard version and a corrosion resistant version.

Note: All part numbers are RoHS Compliant.

800 Series, Intermediate Heavy Duty, 600 V, 0.75" Pitch

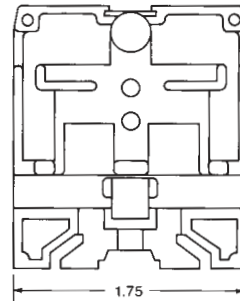

Same part used for both panel and channel mounting.

Material & Finish

Housing Material—Polyamide type 6/6, unfilled

Max Continuous Temp.—125°C [257°F]

Water Absorption (24hrs. % wt. gain)—1.5%

Flammability—UL94V-2

Chemical Resistance—Resistant to aromatic hydrocarbons, strong alkalis

Radiation Resistance (ergs g-1 (C))—8 x 10⁷

Color—Translucent white

Electrical Properties

Voltage Rating—Blocks meet 600V clearance and creepage requirements of NEMA, UL, and CSA standards for general industrial control equipment and panelboards. Withstand voltages in excess of IEEE switchgear standards for 750V.

Breakdown Voltage, AC, 60Hz—
Contact-to-Contact: 8,800V
Contact-to-Ground: 9000V

Dielectric Strength — RH 40% @ Sea Level—470-385 Volts/mil thickness per ASTM D149

Operating Voltage—Blocks meet 600V creepage and clearance requirements; withstand voltage greatly exceeds standards for 750V

UL High Voltage Arc Tracking (in./min.)—.01-.35 [25-8.89]

Contacts

Standard Contacts

Material—Electrical grade copper conductor

Screws—Steel, zinc plated to resist corrosion in most applications

Duramax Contacts (for highly corrosive atmospheres)

Tubular Screw—Electrical grade copper tube with nickel plating; nickel plated brass screws. Nickel plating exceeds specification QQ-N-290 Class 1, Type VII.

Wire Range—#12-1/0 AWG, solid or stranded

Wire Strip Length—11/16" [17.46]

Screw Type—7/16" [11.11] - 20 slotted headless screw

Independent Testing Service Listing and Recognition

UL Wire Sizes—Solid or Stranded, Tubular Screw

- 1 — #1/0 AWG, 1 — #1 AWG
- 1 — #2 AWG, 1 or 2 — #4 AWG
- 1, 2 or 3 — #6 AWG,
- 1, 2, 3 or 5 — #8 AWG
- 1 to 6 — #10 AWG, 1 to 7 — #12 AWG

Description	Part No.	Catalog No.
Tubular Screw, Unpainted	1437395-2	814
Tubular Screw, Painted	1437395-3	824-BU
Corrosion Resistant, Unpainted	5-1437389-8	D814-BU
Corrosion Resistant, Painted	5-1437389-9	D824
End Section	1-1437395-4	830-BU

Notes:

For factory assembled blocks on channel, prefix Catalog # with "0" and suffix with number of blocks desired. Without channel (maximum of 6 sections) delete "0". See page 275 for dimensions and other details.

Example: Ten tubular screw sections preassembled on channel = 082410

For unpainted factory assembled blocks supplied with a removable marking strip add -1 to Catalog Number.

For blocks with two or more different contact sections, imprinted marking strips or special features; consult Technical Support.



Note: All part numbers are RoHS Compliant.

800 Series, Intermediate Heavy Duty Accessories

Mounting Channel

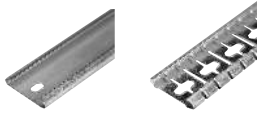

Channel Clamps

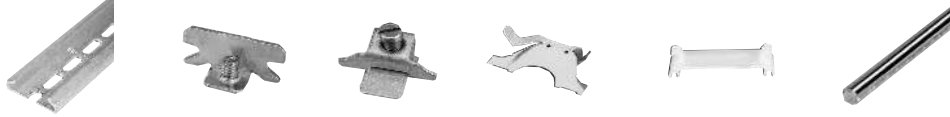

Steel Channel	Break Away Steel	Pre-punched Aluminum Channel	Screw Channel Clamps	Universal Clamps	Snap-In Clamps	See-thru Cover	Ganging Rod
Part Number							
9-1437381-1 9-1437381-8	9-1437381-2	9-1437381-9 1437382-2	9-1437381-5	1437382-3	9-1437381-7	4-1437390-4	3-1437381-9
Catalog Number							
60 63-BU	60-B-36	64 67	61	68	62	93-BU	30-BU
Standard Length							
6 feet 3 feet	3 feet	6 feet 3 feet	—	—	—	—	2 feet

Marking Accessories



Jumpers

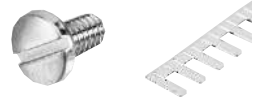

Plastic Cloth Tape	Plastic Cloth Tape	Vinyl Marking Strips	Elevated Marking Strip	Holding Screw	Snap-apart Jumper
Part Number					
1437382-1	8-1437381-0	6-1437381-3	4-1437391-1	7-1437381-8	1-1437382-6
Catalog Number					
66	55-BU	50-BU	52	53-BU	76
Standard Length					
—	50 feet	25 feet	18 inches	—	12 ckt

RELATED PRODUCT DATA

WIRE PINS AND FERRULES: Pages 109-111
 For more information on AMP Standard Terminals and Splices or Quick-Connect FASTON Receptacles and Tabs, request Catalog 82042.

Note: All part numbers are RoHS Compliant.

800 Series, Intermediate Heavy Duty

Flat Base

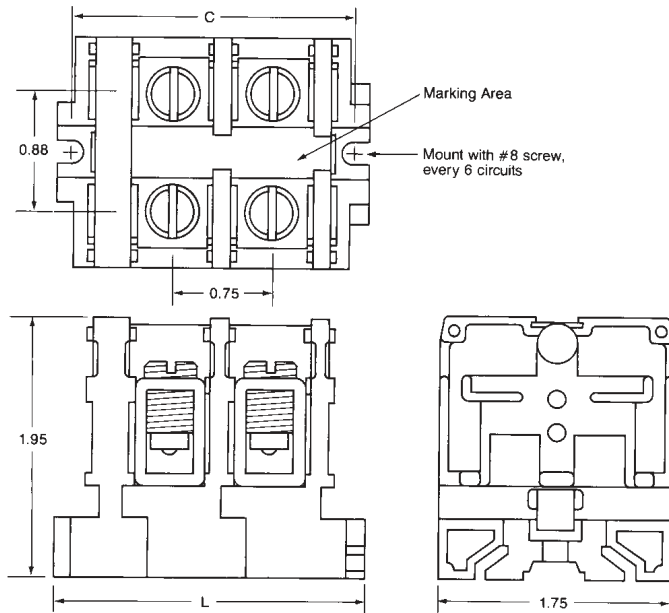

Dovetail Base Mounted On Standard #60 Channel

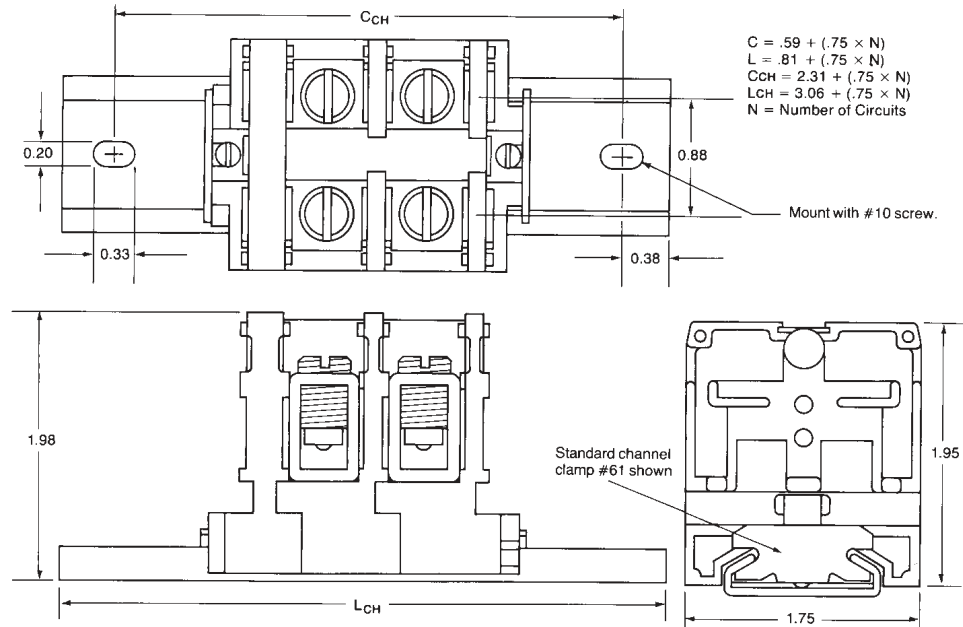

400 Series, Ultra Heavy Duty

Product Facts

400 Series

- Compact 2/0 or 250 kcmil (MCM) block - at least 57 circuits per 6-foot length, 1-3/16" [30.16] center-to-center spacing.
- High current capacity snap-fit sectional block — tubular contacts accept single or combinations of wire sizes as large as 250 kcmil (MCM).
- Two contact styles available; rated up to 270 amperes for copper wire.
- Allen head screws allow maximum torque when using large wire sizes.
- Withstand voltages in excess of IEEE switchgear standards for 750 volts. Meet clearance and creepage spacing specified in UL, CSA, and NEMA Industrial Control Standards for 600 volts.
- Same block directly mounts on surface or channel mounts.
- Only one end section needed per block assembly.
- Readily identify circuits—order blocks with painted marking area or use removable vinyl marking strip. Preprinted marking strips are also available.
- Factory assembled blocks available.
- Ultra Heavy Duty phenolic block sections do not snap-fit with other block styles.



This Ultra Heavy Duty line includes the 400 Series rated up to 270 A.

400 Series, Ultra Heavy Duty, 600 V, 1.19" [30.23] Pitch



Material & Finish

Housing Material—Phenolic, filled flame retardant

Flammability—UL94V-1

Color—Black

Contacts:

Material—Electrical grade copper conductor; plated steel screws resist corrosion

Tubular Screw Type—

- Small: 1/2" [12.7] - 13 Hex
- Large: 3/4" [19.05] - 16 Hex socket set screw

Mechanical Properties

Pitch (terminal spacing)—1.19" [30.23]; 9 circuits/foot

Wire Strip Length—
Tubular Screw (small): 1" [25.4]
Tubular Screw (large): 1" [25.4]

Electrical Properties

Maximum Current—255A for a single 250MCM wire

Operating Voltage—Blocks meet 600V creepage and clearance requirements; withstand voltage greatly exceeds standards for 750V

Wire Range—Tubular Screw (small): #4-#2/0 AWG solid or stranded; Tubular Screw (large): #6 AWG-250 kcmil (MCM) solid or stranded

Dielectric Strength (RH 40% @ sea level)—300 V/mil thickness per ASTM D149

Breakdown Voltage, AC, 60Hz—
Contact-to-Contact: 10,000V
Contact-to-Ground: 10,000V

UL High Voltage Arc Tracking (in./min.)—49-58 [12.45-14.73]

Environmental Properties

Max. Continuous Temperature—150°C [302°F]

Water Absorption (24hrs. % wt. gain)—.45% per ASTM D149

Chemical Resistance—Resistant to acids, alkalis, and aliphatic hydrocarbons and ketones per ASTM D543

Radiation Resistance (ergs g-1 (C))—2.7 x 108

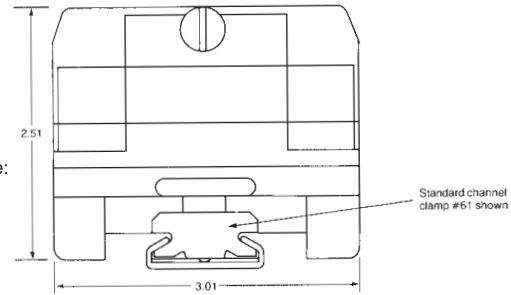
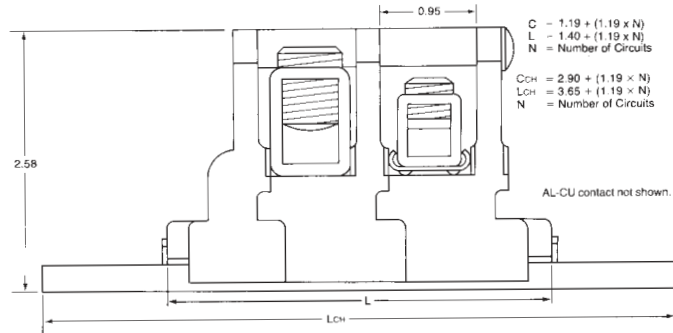
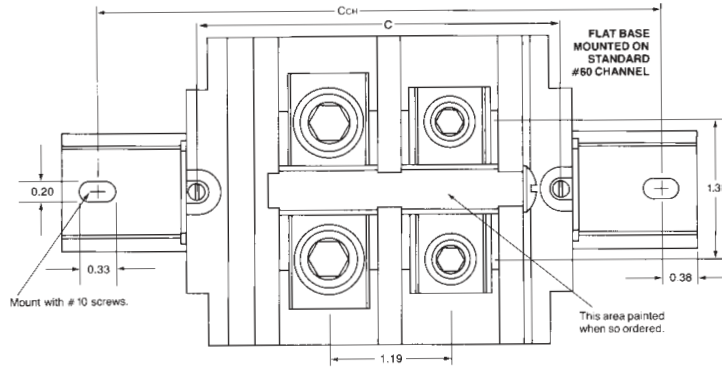

Note: For Direct Mounting, use #10 pan head screws every six circuits. recommended torque: 15-20 in.-lbs.

Same part used for both panel and channel mounting.

Description	Wire Range	Part Number	Catalog Number
Tubular Screw, Unpainted	#14-2/0	1437396-4	416
Tubular Screw, Painted	#14-2/0	1437396-7	426-BU
Tubular Screw, Unpainted	#6-250 kcmil/MCM	1437396-5	417
Tubular Screw, Painted	#6-250 kcmil/MCM	1437396-8	427-BU
End Section	—	1437396-9	430-BU

UL Independent Testing Service Recognitions:

Tubular Screw: Catalog # 416 & 426-BU

- 1 #2/0 AWG, 1 #1/0 AWG, 1 #1 AWG,
- 1 or 2 #2 AWG, 1 to 3 #4 AWG, 1 to 3 #6 AWG,
- 1 to 4 #8 AWG, 1 to 6 #10 AWG, 2 to 8 #12 AWG,

Tubular Screw: Catalog # 417 & 427-BU

- 1 #250kcmil (MCM), 1 #4/0 AWG, 1 #3/0 AWG,
- 1 or 2 #2/0 AWG, 1 or 2 #1/0 AWG, 1 or 2 #1 AWG, 1 to 3 #2 AWG, 1 to 4 #4 AWG,
- 1 to 5 #6 AWG



400 Series, Ultra Heavy Duty Accessories

Mounting Channel



Channel Clamps



Steel Channel	Break Away Steel	Pre-punched Aluminum Channel	Screw Channel Clamps	Universal Clamps	Snap-In Clamps
Part Number					
9-1437381-1 9-1437381-8	9-1437381-2	9-1437381-9 1437382-2	9-1437381-5	1437382-3	9-1437381-7
Catalog Number					
60 63-BU	60-B-36	64 67	61	68	62
Standard Length					
6 feet 3 feet	3 feet	6 feet 3 feet	—	—	—

Marking Accessories



Plastic Cloth Tape	Vinyl Marking Strips	Elevated Marking Strip	Holding Screw
Part Number			
8-1437381-0	6-1437381-3	4-1437391-1	7-1437381-8
Catalog Number			
55-BU	50-BU	52-BU	53-BU
Standard Length			
50 feet	25 feet	18 inches	—

Notes:

For factory assembled blocks on channel, prefix Catalog # with "0" and suffix with number of blocks desired. Without channel (maximum of 6 sections) delete "0".

Example: Ten tubular screw sections preassembled on channel = 041710

For unpainted factory assembled blocks supplied with a removable marking strip add -1 to Catalog Number.

For blocks with two or more different contact sections, imprinted marking strips or special features, consult Technical Support.

Related Product Data

Wire Pins and Ferrules—Pages 109-111

For more information on AMP Standard Terminals and Splices or Quick-Connect FASTON Receptacles and Tabs, request Catalog 82042.

Note: All part numbers
are RoHS Compliant.

Engineering Notes



Fuse & Switch

Product Facts

High Density Blocks

- n Fuse and Switch Blocks rated 15A and 300V.
- n High Density 0.36" [9.14] centerline spacing saves panel space; at least 33 circuits per foot.

Fuse Blocks

- n Provide in-line circuit protection for virtually any circuit or group of circuits — select contacts for terminated or unterminated wire.
- n Remove, check and replace fuses safely and quickly — switch action fuse blocks open circuits before fuse can be removed or installed.
- n Contacts conservatively rated to 30 amperes.

Switch Blocks

- n Quickly and easily interrupt a circuit or group of circuits — insert switch blocks directly in line. Contacts available for terminated or unterminated wire.
- n Keep circuits open for extended periods — switch blade can be removed entirely from block for lock-out protection.
- n Rated to 15 amperes.

Common Features of 300 & 0300 Series

- n At least 91 circuits per 6-foot length, 3/4 inch center-to-center spacing.
- n Blocks meet 600 volt clearance and creepage spacings specified in UL, CSA, and NEMA Industrial Control Standards.
- n Choose nylon housing material — for more rugged applications; polypropylene for fire retardant characteristics.
- n Dovetail base fits standard mounting channel — can also be mounted on flat surfaces.
- n Only one end section needed per block assembly.

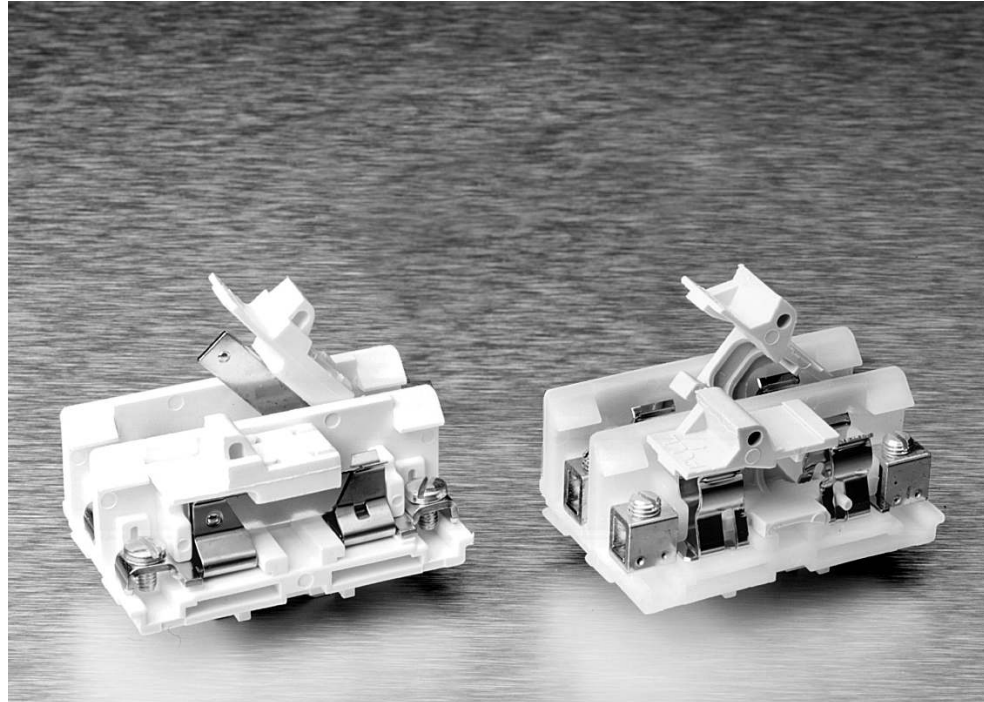

- n Readily identify circuits — mark directly on white, matte-surface puller assembly, marking tab on block, or use removable marking tape.
- n Open or close several circuits simultaneously — holes in puller handles allow use of nylon “ganging” rods.
- n Fuse and Switch block sections snap-fit with 300 & 600 Volt, phenolic Medium Duty, Heavy Duty, and Intermediate Heavy Duty blocks.

This broad line features High Density Blocks (Series 0135), Nylon & Polypropylene Blocks (Series 0300) and Phenolic Blocks (Series 300).

Note: All part numbers are RoHS Compliant.

0300 Series, Fuse & Switch, Nylon and Polypropylene

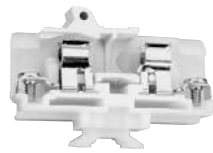

**Fuse Block
Strap Screw**

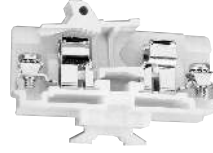

**Fuse Block
Strap Clamp**

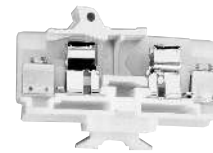

**Fuse Block
Tubular Screw**

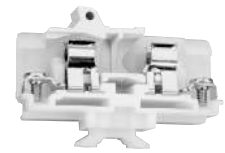

**Switch Block
Strap Screw**

Characteristics

Type of Block	Model	Part Number	Model	Part Number	Model	Part Number	Model	Part Number
Channel Mount (Dovetail Base)								
Nylon	0311	1437397-1	0318	1437397-3	0312	1437397-2	0371	1-1437397-7
Polypropylene	P0311	4-1437397-0	P0318	4-1437397-3	P0312	4-1437397-2	P0371	4-1437397-4
Corrosion Resistant Nylon	D0311	1-1437389-1	D0318	1776726-1	D0312	1-1437389-2	D0371	1-1437389-7
Corrosion Resistant Polypropylene	DP0311	6-1437389-2	DP0318	1776727-1	DP0312	6-1437389-3	DP0371	1776728-1

Contact Type



Specifications

Wire Range (AWG) Solid & Stranded	22-8	18-8	18-8	22-8
Wire Strip Length (in.)	—	1/2	1/2	—
Screw Type	10-32 binding head	8-32 pan head w/clamp	1/4"-28 set screw	10-32 binding head

Ampacity

25 A	25 A	25 A	15 A
------	------	------	------

End Sections

Channel Mount, Nylon	0380	2-1437397-0	0380	2-1437397-0	0380	2-1437397-0	0380	2-1437397-0
Channel Mount, Polypropylene	P0380	4-1437397-7	P0380	4-1437397-7	P0380	4-1437397-7	P0380	4-1437397-7

Notes: Standard package is 100 pieces for contact, 25 pieces for end section.

For factory assembled blocks on channel, suffix Catalog Number with number of blocks desired. Without channel delete "0" prefix on Catalog Number.

EXAMPLE:

Ten strap-screw fuse block sections preassembled on channel = 031110.

For blocks with two or more contact types, preassembled with other blocks, imprinting or special features, consult Technical Support.

0300 Series, Fuse & Switch, Nylon and Polypropylene (Continued)



**Switch Block
Strap Clamp**

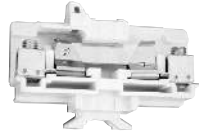

**Switch Block
Tubular Screw**

Model	Part Number	Model	Part Number
0378	1-1437397-9	0372	1-1437397-8
P0378	4-1437397-6	P0372	4-1437397-5
D0378	1776729-1	D0372	1776731-1
DP0378	1776730-1	DP0372	1776732-1



18-8	18-8		
1/2	1/2		
8-32 pan head w/clamp	1/4"-28 set screw		
15 A	15 A		
0380	2-1437397-0	0380	2-1437397-0
P0380	4-1437397-7	P0380	4-1437397-7

Fuse Puller:

Material	High-temperature, glass-reinforced nylon
Color	Black

Switch Handle:

Material	Polypropylene
Color	White

Specifications

Pitch—0.75" [19.05] centerline, 16 circuits per foot

Voltage Rating—Blocks meet 600 volt creepage and clearance requirements of NEMA, UL and CSA for general industrial control equipment and panelboards. Withstand voltages greatly in excess of IEE switchgear standards for 750 volts.

Fuse Size—Any 13/32 x 1-1/2 in. [10.32 x 28.10] ferrule type cartridge fuse up to 25 amps, indicating or non-indicating, which meets Mil. Spec. F-15160.

Standard Contacts

Material—Electrical grade copper or copper alloy conductor. Steel Screws plated to resist corrosion in most industrial applications

AL-CU Tubular Screw—Aluminum compatibility with aluminum or copper conductors. AL-CU is tin-plated brass.

**Environmental Contacts
(for highly corrosive atmospheres)**

Tubular Screw—Electrical grade copper tube with nickel plating. Nickel plated brass screws.

Strap Screw—Nickel plated brass straps and screws. Nickel plating meets specification QQ-N-290A Class I, Grade G.

Polyamide Material:

Housing Material—Polyamide, Unfilled Type 6/6

Max. Continuous Temperature—125°C, (257°F)

Breakdown Voltage (AC, 60 Hz)—

Contact-to-Contact: 7000V

Contact-to-Ground: 10,000V

Dielectric Strength (RH 40% at Sea Level)—470-385 Volts/mil thickness Per ASTM D149

UL High Voltage Arc Tracking (inches/min.)—0.1-.35 [.25-8.89]

Water Absorption (24 hrs. % wt. gain)—1.5% per ASTM D570

Flammability—UL94V-2

Chemical Resistance—Resistant to aromatic hydrocarbons, strong alkalies per ASTM D543

Radiation Resistance (ergs g-1 (C))—8 x 107

Color—Translucent White

Polypropylene Material:

Housing Material—Polypropylene, Filled self-extinguishing

Max. Continuous Temperature—105°C, (221°F)

Breakdown Voltage (AC, 60Hz)—

Contact-to-Ground: 10,000V

Contact-to-Contact: 7000V

Dielectric Strength (RH 40% at Sea Level)—500 Volts/mil thickness per ASTM D149

UL High Voltage Arc Tracking (inches/min.)—Did not track

Water Absorption (24 hrs. % wt. gain)—0.02% Per ASTM D570

Flammability—UL94V-0

Chemical Resistance—Resistant to most acids, alkalines, and saline solutions. Also resistant to higher aliphatic solvents and polar substances per ASTM D543

Radiation Resistance (ergs g-1 (C))—No data Available

Color—Opaque White

Note: All part numbers are RoHS Compliant.

0300 Series, Fuse & Switch, Nylon and Polypropylene (Continued)

Mounting Channel



Steel Channel	Break Away Steel	Pre-punched Aluminum Channel
Part Number		
9-1437381-1 9-1437381-8	9-1437381-2	9-1437381-9 1437382-2
Catalog Number		
60 63-BU	60-B-36	64 67
Standard Length		
6 feet 3 feet	3 feet	6 feet 3 feet

Channel Clamps

Marking Accessories



Screw Channel Clamps	Universal Clamps	Snap-In Clamps	Ganging Rod	Coated Cloth Marking tape
Part Number				
9-1437381-5	1437382-3	9-1437381-7	3-1437381-9	8-1437381-0
Catalog Number				
61	68	62	30	55-BU
Standard Length				
—	—	—	2 feet	50 feet

Related Product Data

Wire Pins and Ferrules—Pages 109-111
For more information on AMP Standard Terminals and Splices or Quick-Connect FASTON Receptacles and Tabs, request Catalog 82042.

Note: All part numbers are RoHS Compliant.

0300 Series, Fuse & Switch, Nylon and Polypropylene (Continued)

Dovetail Base Mounted On Standard #60 Channel. May Also Be Mounted Direct

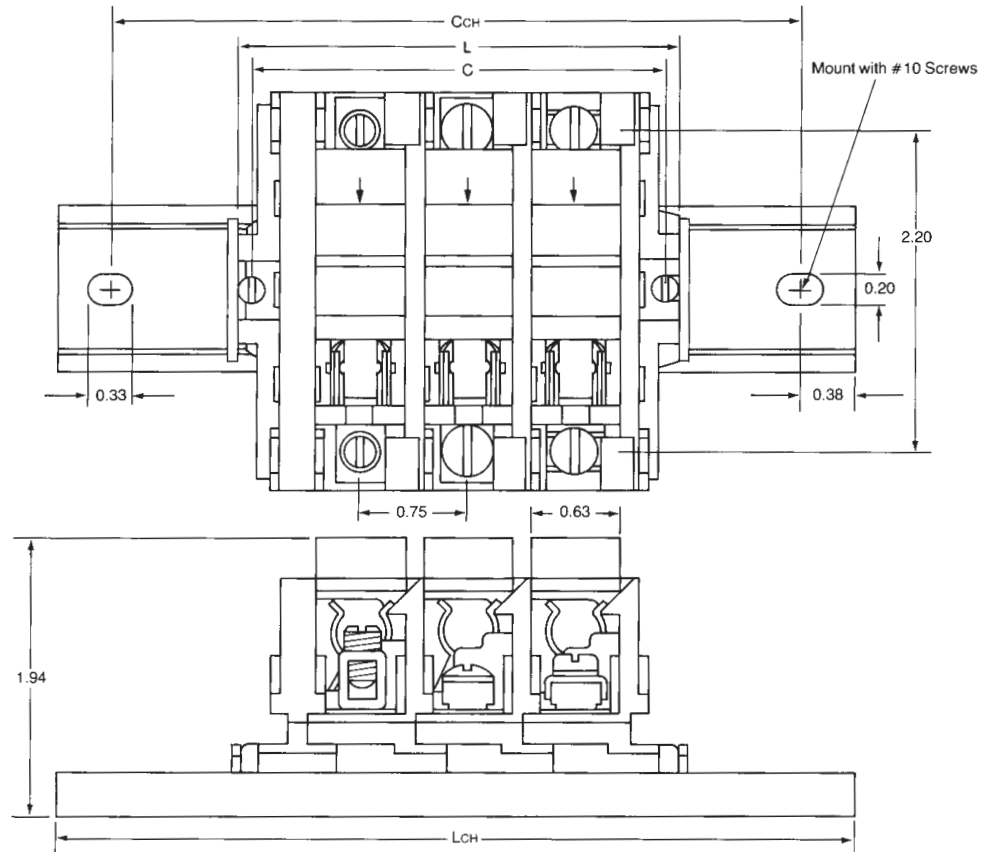

CHANNEL MOUNTED
 $CCH = 2.28 + (.75 \times N)$
 $LCH = 3.03 + (.75 \times N)$
 N = Number of Circuits

DIRECT MOUNTED
 $C = .56 + (.75 \times N)$
 $L = .78 + (.75 \times N)$
 N = Number of Circuits

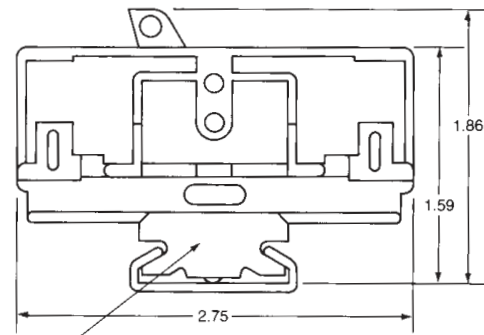

Standard Channel Clamp #61 Shown

Note: All part numbers are RoHS Compliant.

300 Series, Fuse & Switch, Phenolic

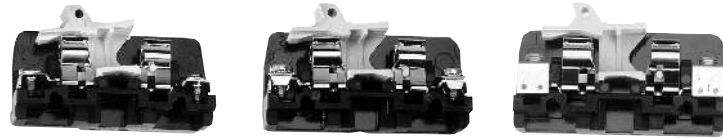

Characteristics

Strap Screw

Strap Clamp

Tubular Screw

Type of Block	Model	Part Number	Model	Part Number	Model	Part Number
Direct Mount (Flat Base)						
Fuse Block with Puller	351	2-1437397-8	358	3-1437397-1	352	3-1437397-0
Fuse Block without Puller	361	2-1437397-2	368-BU	3-1437397-5	362-BU	3-1437397-3
Switch Block	341	2-1437397-5	348	2-1437397-7	342	2-1437397-6
Channel Mount (Dovetail Base)						
Fuse Block with Puller	0351	1437397-9	0358	1-1437397-2	0352	1-1437397-0
Fuse Block without Puller	0361	1437397-4	0368	1-1437397-6	0362	1-1437397-5
Switch Block	0341	1437397-6	0348	1437397-8	0342	1437397-7

Contact Type



Specifications

Wire Range (AWG) Solid & Stranded	22-8	18-8	18-8
Wire Strip Length (in.)	—	1/2	1/2
Screw Type	8-32 binding head	8-32 pan head w/clamp	1/4"-28 set screw

Ampacity

Fuse Blocks	25A	25A	25A
Switch Blocks	15A	15A	15A

End Sections

No Contact, Flat Base	330-BU	2-14376397-4	330-BU	2-14376397-4	330-BU	2-14376397-4
No Contact, Dovetail Base	0330	14376397-5	0330	14376397-5	0330	14376397-5

Comparison (Type of Block)



Direct Mount (Flat Base)

Channel Mount (Dovetail Base)

Notes: Standard package is 10 pieces.

For factory assembled blocks, suffix Catalog Number with number of blocks desired (Maximum number of flat base preassembled sections is 6).

EXAMPLE:

Twelve strap screw, fuse block sections preassembled on channel = 035112.

Six flat tubular screw, switch blocks preassembled without channel for direct mounting = 3426

For blocks with two or more different contact sections, preassembled with other blocks, imprinting or special features, consult Technical Support.

Environmental contacts for highly corrosive atmospheres are available with Nickel plating on non-ferrous hardware. To order, prefix Catalog Number with "D".

Except
Switch
Blocks



LR25557 E34934

Note: All part numbers are RoHS Compliant.

300 Series, Fuse & Switch, Phenolic—Accessories

Mounting Channel

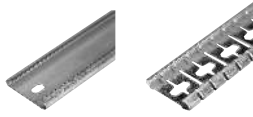

Fuse Puller



Steel Channel	Break Away Steel	Pre-punched Aluminum Channel	Fuse Puller	3-Gang Fuse Puller
Part Number				
9-1437381-1 9-1437381-8	9-1437381-2	9-1437381-9 1437382-2	2-1437397-1	2-1437397-2
Catalog Number				
60-BU 63-BU	60-B-36	64 67	31-BU	32
Standard Length				
6 feet 3 feet	3 feet	6 feet 3 feet	—	—

Channel Clamps



Marking Accessories



Screw Channel Clamps	Universal Clamps	Snap-In Clamps	Ganging Rod	Coated Cloth Marking Tape
Part Number				
9-1437381-5	1437382-3	9-1437381-7	3-1437381-9	8-1437381-0
Catalog Number				
61	68	62	30	55-BU
Standard Length				
—	—	—	2 feet	50 feet

Physical Properties

Housing Material—Phenolic, filled flame retardant
Color—Black

Contacts

Material—Copper alloy spring clips. Steel screws plated to resist corrosion in most industrial applications

Strap Screw—11/32" max. lug width

Mechanical Properties

Pitch (terminal spacing)—0.75" [19.05] (16 circuits per foot)

Switch Handles

Material—Polypropylene

Color—White

Electrical Properties

Operating Voltage—Blocks meet 600V creepage and clearance requirements of NEMA, UL and CSA standards for general industrial control equipment and panelboards; withstand voltage exceeds IEEE switchgear standards for 750V

Dielectric Strength (RH 40% @ sea level)—300 volts/mil thickness per ASTM D149

UL High Voltage Arc Tracking (inches/min.)—.49-.58 [12.45-14.73]

Fuse Size—Any 13/32 x 1-1/2 in. [10.32 x 38.10] ferrule type cartridge fuse up to 25 amps, indicating or non-indicating, which meets Mil. Spec. F-15160, is recommended.

Environmental Properties

Max. Service Temperature—150°C (302°F)

Water Absorption (24hrs. % wt. gain)—0.45% per ASTM D570

Flammability Rating—UL94V-1

Chemical Resistance—Resistant to acids, alkalies, and aliphatic hydrocarbons and ketones, per ASTM D543

Radiation Resistance (ergs g-1 (C))—2.7 x 108

UL Independent Testing Service Recognitions:

Wire Sizes—Solid or Stranded, Tubular Screw Cat. # 362-BU, 0362

1 #4 AWG, 1 #6 AWG, 1 #8 AWG,
1 to 4 #10 AWG, 1 to 5 #12 AWG, 1 to 6 #14 AWG, 1 to 6 #16 AWG, 1 to 8 #18 AWG

Related Product Data

Wire Pins and Ferrules—Pages 135-137

For more information on AMP Standard Terminals and Splices or Quick-Connect FASTON Receptacles and Tabs, request Catalog 82042.

Cat #'s
31 and
32



E63810

Note: All part numbers are RoHS Compliant.

300 Series, Fuse & Switch, Phenolic, Flat Base

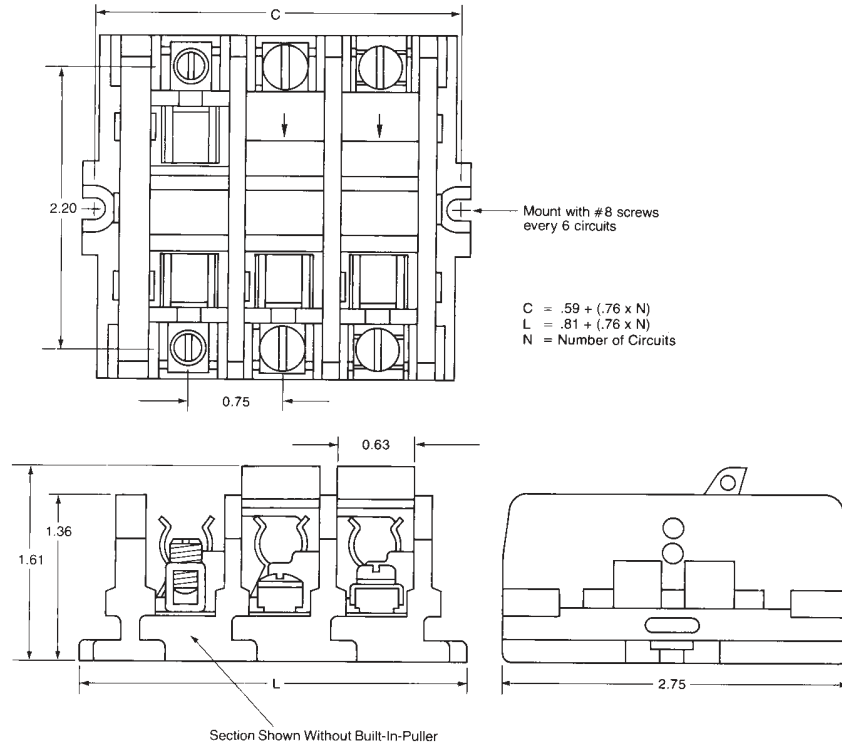

Dovetail Base Mounted On Standard #60 Channel

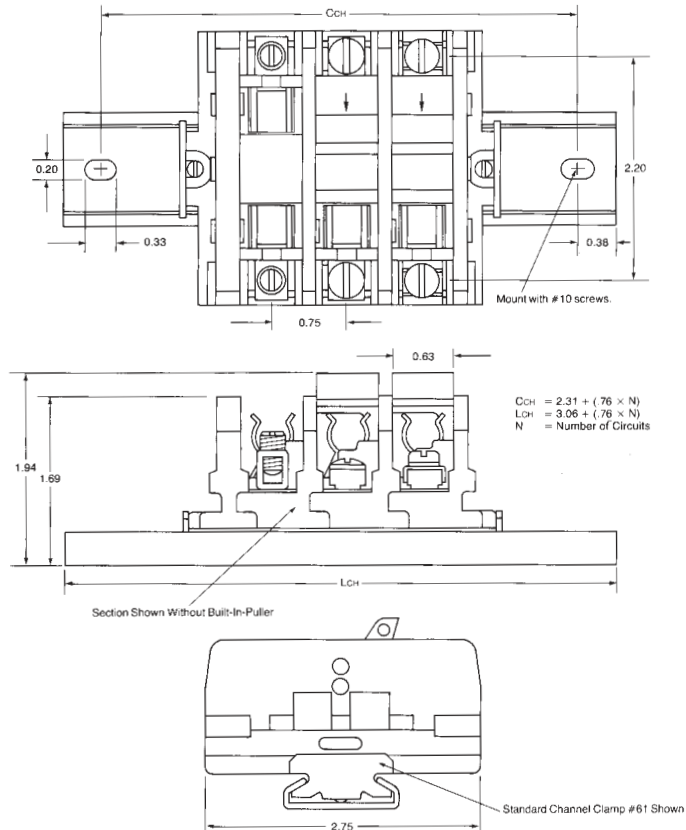

One-Piece Phenolic Blocks

Product Facts

- n Two, four, six, eight, and twelve circuit models available — 5/8" [15.88] center-to-center contact spacing.
- n No assembly required — each is a single, easily installed unit.
- n Three contact styles available — strap screw, captive strap clamp, and moving tubular contact.
- n Use wire up to #6 AWG with tubular contact. Strap screw and strap clamp contacts are available for #8 and smaller.
- n Withstand voltages in excess of IEEE standards for 750 volts. Meet clearance and creepage spacings specified in UL, CSA, and NEMA Industrial Control Standards for 600 Volts.
- n Strap contacts rated at 50 amperes — tubular contact conservatively rated at 70 amperes.
- n Pilot point screws supplied with strap screw and clamp contacts — speeds installation time.
- n Plain white marking strip supplied with each block — circuits are easily identified.
- n Special purpose blocks available—choose from blocks with solder posts, printed circuit board pins, or nuts on screw posts, removable circuit links, and a shorting bar.

Traditionally, these rugged One-Piece Blocks are the standard means of connection for heavy industrial applications like rail transport, utility, and traffic control industries. Ideal for dirty and vibration prone environments.

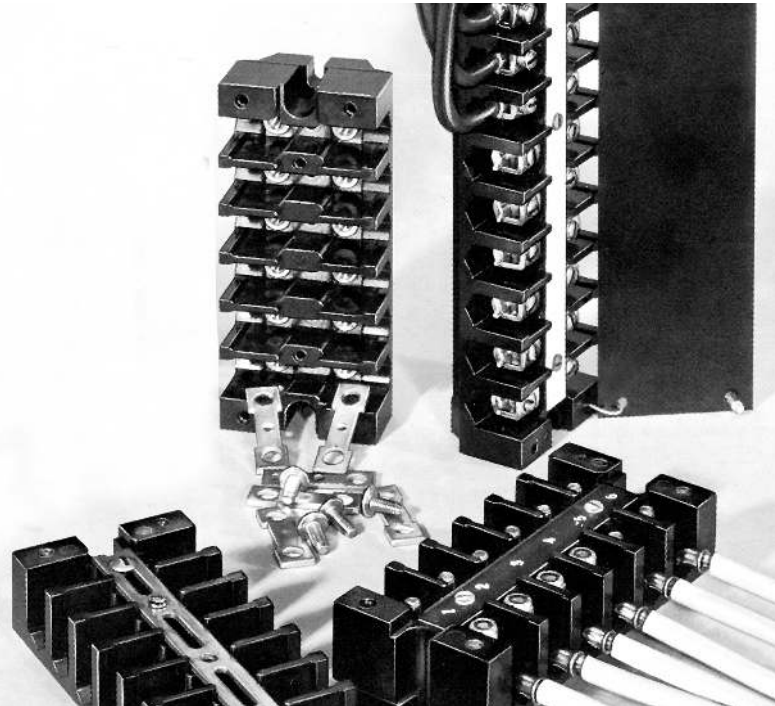

Note: All part numbers are RoHS Compliant.

B100, #B100 Series, One-Piece Blocks, 600 V — Phenolic

Material & Finish

Housing Material—Phenolic, filled flame retardant

Flammability—UL94V-1

Color—Black

Contacts

Standard Material—Electrical grade copper or copper alloy conductor. Steel screws plated to resist corrosion in most industrial applications.

Brass Material—For Corrosive Environment (2B100, 4B100 Series) Nickel plated brass straps and screws. Meets specification QQ-N-290A Class 1, Grade G

Wire Range—Strap Screw: #18-8 AWG solid or stranded; Tubular Clamp: #14-6 AWG solid or stranded

Screw Type—Strap Screw: #10-32 Binding Head; Tubular Clamp: #1/4" [6.35]-28 Set Screw

Strap Screw—7/16" [11.11] max. lug width

Mechanical Properties

Pitch (terminal spacing)— .63" [16.00]

Wire Strip Length—Strap Screw: as needed for lugging; Tubular Clamp: 1/2" [12.1]

Electrical Properties

Maximum Current—70A for a single #6 AWG wire

Operating Voltage—Blocks meet 600V creepage and clearance requirements for general industrial control equipment and panelboards; greatly exceeds IEEE switchgear standards for 750 volts.

Dielectric Strength (RH 40% @ sea level)—300 Volts/mil thickness per ASTM D149

UL High Voltage Arc Tracking (in./min.)—.49-.58 [12.45-14.73]

Environmental Properties

Max. Continuous Temperature—150°C (302°F)

Water Absorption (24hrs. % wt. gain)—.45% per ASTM D570

Chemical Resistance—Resistant to acids, alkalis, and aliphatic hydrocarbons and ketones per ASTM D543



Radiation Resistance (ergs G⁻¹ (C))—2.7 x 10⁸ min

UL Independent Testing Service Recognitions

Wire Sizes—Solid or Stranded, Tubular Clamp

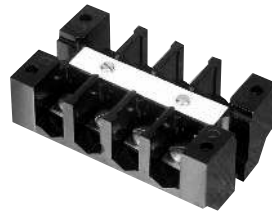
1—#6 AWG, 1—#8 AWG, 1or 2—#10 AWG, 1or 2—#12 AWG, 1 to 3—#14 AWG, 1—#10 & 1—#12 AWG
1—#12 & 1—#14 AWG



Circuits	Steel Screw w/Strap		Tubular Clamp		Brass Screw w/Strap	
	Part Number	Catalog Number	Part Number	Catalog Number	Part Number	Catalog Number
Contact Type						
						
AMPACITY						
	50A		65A		50A	
Standard						
2	2-1437382-6	B102	2-1437382-8	B102S	2-1437381-0	2B102
4	3-1437382-0	B104	3-1437382-6	B104S	2-1437381-2	2B104
6	4-1437382-0	B106-BU	4-1437382-5	B106S	2-1437381-6	2B106
8	4-1437382-9	B108	5-1437382-5	B108S	3-1437381-0	2B108
12	5-1437382-9	B112-BU	6-1437382-7	B112S	3-1437381-3	2B112
Shorting*						
2	4-1437381-0	3B102P	—	—	5-1437381-6	4B102P
4	4-1437381-1	3B104P	—	—	5-1437381-7	4B104P
6	4-1437381-3	3B106P	—	—	5-1437381-8	4B106P
8	4-1437381-5	3B108P	—	—	5-1437381-9	4B108P
12	4-1437381-7	3B112P	—	—	6-1437381-0	4B112P

Circuits	Strap Screw #8 & Smaller		Threaded Post & Nut	
Removable Link				
2	8-1437381-4	5B102	—	—
4	8-1437381-5	5B104	—	—
6	8-1437381-7	5B106	—	—
8	8-1437381-8	5B108	—	—
12	9-1437381-0	5B112	—	—
Stud, #10-32				
2	—	—	1-1437382-8	7B102
4	—	—	2-1437382-0	7B104
6	—	—	2-1437382-1	7B106
8	—	—	2-1437382-2	7B108
12	—	—	2-1437382-3	7B112

Notes:

For prenumbered marking strip, add suffix "N" to Catalog Number. Cannot be used on 3B or 4B series.

For factory assembled hinged cover, add suffix "H" to Catalog Number. Cannot be used on 3B or 4B series.

For factory assembled thumbscrew-fastened cover, add suffix "T" to Catalog Number. Cannot be used on 3B or 4B series.

Screws and removable links shipped unassembled.

*Shorting blocks are supplied with 2 shorting screws each.

Except for 3B and 4B Series



LR25557 E63810

B100, #B100 Series, One-Piece Blocks, 600 V — Phenolic Accessories

Covers and Marking



Circuits	Laminated Phenolic Cover		Shorting Block Cover		White Marking Strip		Numbered Marking Strip	
	Part Number	Catalog Number	Part Number	Catalog Number	Part Number	Catalog Number	Part Number	Catalog Number
2	7-1437382-5	C102-BU	9-1437382-2	CS102	1-1437383-5	S102	1776733-2	N102
4	7-1437382-6	C104-BU	9-1437382-3	CS104	1-1437383-6	S104	1-1437383-1	N104
6	7-1437382-7	C106-BU	9-1437382-4	CS106	1-1437383-7	S106	1-1437383-2	N106
8	7-1437382-8	C108-BU	9-1437382-5	CS108	1-1437383-8	S108	1-1437383-3	N108
12	7-1437382-9	C112-BU	9-1437382-6	CS112	1-1437383-9	S112	1-1437383-4	N112

Jumpers



Hardware



Circuits	30A Copper Jumpers		50A 12 Circuit Jumpers		Connecting Link		Lock Nuts		Shorting Screw	
	Part No.	Catalog No.	Part No.	Catalog No.	Part No.	Catalog No.	Part No.	Catalog No.	Part No.	Catalog No.
2	1437383-2	J102	—	—	—	—	—	—	—	—
4	1437383-3	J104	—	—	—	—	—	—	—	—
6	1437383-4	J106	—	—	—	—	—	—	—	—
8	1437383-5	J108	—	—	—	—	—	—	—	—
12	1437383-6	J112	1437395-9	HJ112	—	—	—	—	—	—
Hardware										
—	—	—	—	—	9-1437382-0	CL101	1437383-7	LN101-BU	7-1437381-7	51-BU

Related Product Data

Wire Pins and Ferrules—Pages 109-111
For more information on AMP Standard Terminals and Splices or Quick-Connect FASTON Receptacles and Tabs, request Catalog 82042.



Note: All part numbers are RoHS Compliant.

B100, #B100 Series, One-Piece Blocks, 600 V — Phenolic

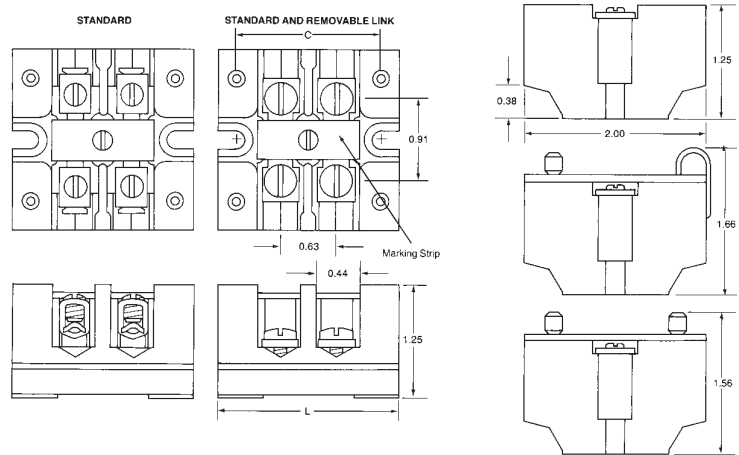

No. of Ckts.	C	L
2	1.63	2.00
4	2.88	3.25
6	4.13	4.50
8	5.38	5.75
12	7.88	8.25

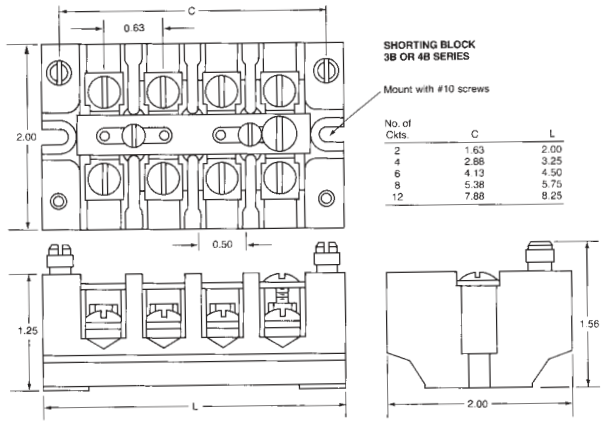

**SHORTING BLOCK
3B OR 4B SERIES**

Mount with #10 screws

No. of Ckts.	C	L
2	1.63	2.00
4	2.88	3.25
6	4.13	4.50
8	5.38	5.75
12	7.88	8.25

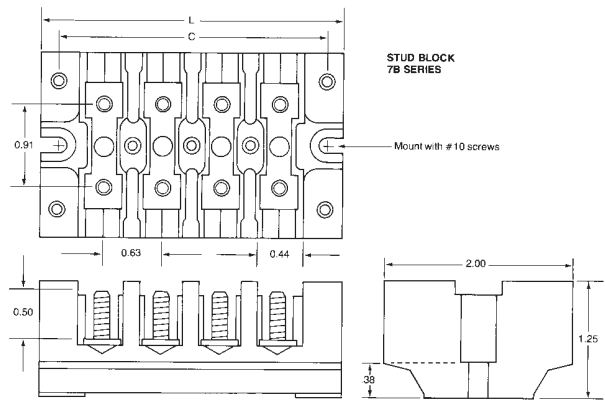

**STUD BLOCK
7B SERIES**

Mount with #10 screws

Note: All part numbers are RoHS Compliant.

Pre-Printed Marking Strips

Circuit identification is greatly simplified with the use of pre-printed strips for BUCHANAN terminal blocks. These hot-stamped strips are available for all snap-assembled sections (except Fuse, Switch, and Circuit Breaker models which are marked individually). The strips can be ordered separately or pre-installed on factory assembled sectional block units.

Unlike painted or screened letters, hot-stamped letters are designed to not rub or flake off during industrial use so that they will retain their legibility.

Marking strips are stamped with consecutive numbers that can be ordered to read from left-to-right or right-to-left, and in vertical or horizontal positions. Number sequences can begin with any number. This allows circuits to be identified in a manner most consistent with the terminal block application.

M 50 005 13 G

A B C D E

- A** M = Hot-Stamped Marking Strip
- B** **Terminal Block Series and Designator**
 10 = Miniature or Single Tier
 12 = Double Tier
 67 = 900 Series Medium Duty
 24 = Nylon Heavy Duty
 21 = Phenolic Heavy Duty
 80 = Intermediate Heavy Duty
 40 = Ultra Heavy Duty
 T2 = TSB230
 T5 = TSB500
 T6 = TSB1000
 T7 = TSB2000
- C** **Number of Circuits to be Consecutively Numbered**
 (Use three digits: Ex.: 005 = 5, 055 = 55, etc.)
- D** **Marking Style Options**
 11 = 1 2 3 4 5...
 12 = ...5 4 3 2 1
 13 = ... 1 2 3 4 5...
 14 = ... 5 4 3 2 1
- E** **"First Number In Series" Designator***

A = 1	F = 6
B = 2	G = 7
C = 3	H = 8
D = 4	J = 9
E = 5	K = 0

Marking Strip Installed On A Factory-Assembled Terminal Block

615 005 11 A

A B C D

- A** Basic Sectional Block Catalog #
- B** **Number of Circuits to be Factory Assembled and Consecutively Numbered**
 (Use three digits: Ex: 005 = 5, 055 = 55, etc.)
- C** **Marking Style Options**
 11 = 1 2 3 4 5...
 12 = ...5 4 3 2 1
 13 = ... 1 2 3 4 5...
 14 = ... 5 4 3 2 1
- D** **"First Number In Series" Designator***

A = 1	F = 6
B = 2	G = 7
C = 3	H = 8
D = 4	J = 9
E = 5	K = 0

* Letters in this position designate the first number to be used in the consecutive sequence. Ex.: "A" would start the sequence with the number 1. "EK" would start the sequence with the number 50. "BKK" would start the series with 200. For non-sequential numbering and special characters, consult Technical Support.

Technical Summary

Cat. No.	Terminal Block or Product Line	Contact Type Material Plate	Screw		Material & Plating	Recommended Screwdriver Dimensions		Wire Strip Length	Wire Range AWG	Rec. Torque in. - lb.
			Screw Style	Slot Size		Tip Thick	Tip Width			
105-BU 115 125-BU	High Density Tubular Clamp	Electroplated Tubular Copper Contact	6-32 Slotted Screw	033" Wide x .040" Deep [.84 x 1.02] Steel	Steel Electroplated	.020" [.51]	9/64" [.02]	5/16" [7.94]	#12-30	10
211 241	HeavyDuty Strap Screw	Copper Alloy Strap Electroplated	Binding Head 10-32 Thread	062" Wide x 062" Deep [1.57 x 1.57]	"	.037" [.94]	1/4" [6.35]	As Needed for Lugging	#8 or Smaller	12
212 222-BU 242	Heavy Duty Tubular Screw	Electroplated Tubular Copper Contact	Headless 1/4"-28 Thd. Slotted	3/64" Wide x 1/16" Deep [1.19 x 1.59]	"	"	"	1/2" [12.7]	#4-18	35
213 243	Heavy Duty Tubular Clamp	"	"	"	"	"	"	#6-18	35	
218 248	Heavy Duty Strap Clamp	Copper Alloy Strap Electroplated	Pan Head Saddle Clamp 8-32 Thd.	3/64" Wide x 3/64" Deep [1.19 x 1.19]	"	"	"	#8-18	12	
351 361 0311	Fuse Block Strap Screw	Copper Alloy Electroplated Spring Temper	Binding Head 8-32 Thd.	"	"	"	"	As Needed for Lugging	#8 or Smaller	10
358 368 318	Fuse Block Strap Clamp	"	Pan Head w/SaddleClp. 8-32 Thd.	"	"	"	"	1/2" [12.7]	#8-18	"
352 362-BU 312	Fuse Block Tubular Screw	Same as above except use H.D. Tubular Contact	Headless 1/4"-28 Thd. slotted	"	"	"	"	"	"	"
341 371 342	Switch Block Strap Screw	CopperAlloy Electroplated Spring Temper	"	"	"	"	"	As Needed for Lugging	#8 or Smaller	"
348 0378	Switch Block Strap Clamp	"	Pan Head w/SaddleClp 8-32 Thd.	"	"	"	"	1/2" [12.7]	#8-18	
342 0372	Switch Block Tubular Screw	Same as above except use H D. Tubular Contact	"	"	"	"	"	"	"	
416 426-BU	Extra Heavy Duty Tubular Screw	Electroplated-Tubular Copper Contact	1/2"-13 Hex Socket Hd. Set Screw	1/4" [6.35] Hex	"	1/2" [12.7] Hex	T-Bar Key	7/8" [22.23]	#12-2/0	200

Note: Representative Catalog Numbers Listed.

Technical Summary (Continued)

Cat. No.	Terminal Block or Product Line	Contact Type Material plate	Screw		Material & Plating	Recommended Screwdriver Dimensions		Wire Strip Length	Wire Range AWG	Rec. Torque in. - lb.
			Screw Style	Slot Size		Tip Thick	Tip Width			
417	Extra HD	Electroplated	3/4"-16 Hex Socket Head Set Screw	3/8" Hex [9.53]	Steel Electroplated	3/8" Hex [9.53]	KeyT-Bar	1" [25.4]	#6-250	375 kcmil (MCM)
427-BU	Tubular Screw	Tubular Copper Contact								
517 617 717	Medium Duty Quick-Connect	1/4" Wide QC .032" Thk Copper Alloy Electroplated	N/A	N/A	N/A	N/A	N/A	N/A	N/A	N/A
1546235-1	Medium Duty Tubular Clamp	Electroplated Tubular Copper Contact	10-32 Slotted Hd	.046" Wide x .046" Deep [1.17 x 1.17]	Steel Electroplated	.032" [.81]	3/16" [4.76]	11/32" [8.73]	#10-22	8
1546152-1	Medium Duty QC & Tubular Screw	1/4" Wide QC .032" Thk. Tubular Contact Both Copper Alloy Electroplated	"	"	"	"	"	"	#8-18	10
1546148-1	Medium Duty Tubular Screw	Electroplated Tubular Copper Contact	"	"	"	"	"	"		8
1546143-1	Medium Duty Strap Screw	Copper Alloy Strap Electroplated	6-32 Thd. Slotted Binding Hd.	3/64" Wide x 3/64" Deep [1.19 x 1.19]	"	"	"	As Needed for Lugging	#8 or Smaller	12
824-BU	Intermediate Tubular Screw	Electroplated Tubular Copper Contact	7/16"-20Thd. Slotted Headless	5/64" Wide x 5/64" Deep [1.98 x 1.98]	"	.041" [1.04]	3/8" [9.53]	11/16" [17.46]	#12-1/0	50
B102 B112-BU	One-Piece Blk. Strap Screw	Copper Alloy Strap Electroplated	10-32 Thd. Slotted Binding Hd.	1/16" Wide x 1/16" Deep [1.59 x 1.59]	"	.037" [.94]	1/4" [6.35]	As Needed for Lugging	#8 or Smaller	20
B102S B112S	One-Piece Blk. Tubular Contact	Tubular Contact	1/4" -28 Thd. Headless Set Screw	3/64" Wide x 3/64" Deep [1.19 x 1.19]	"	"	"	1/2" [12.7]	#6-14	45

Note: Representative Catalog Numbers Listed.

UL 1059 Basic Voltage Rating

Voltage ratings of terminal blocks are based on the minimum spacing between electrical conductive parts of opposite polarity or between an electrically conductive part and a metal mounting surface measured under two conditions: Through Air, defined as the distance an arc must take through the air to go from one live conductor to another or from a live conductor to ground; and Over Surface, defined as the distance an arc must take over a surface of the insulating material going from one terminal to ground, assuming the arc will travel along the surface rather than through the air. The following chart shows UL 1059 spacing requirements in inches.

Voltage Rating

Description	Voltage	Spacing Requirements	
		Thru Air	Over Surface
Class A Service equipment including deadfront switchboards, panel boards, service entrance devices, etc.	51 - 150 151 - 300 251 - 600	1/2 [12.7] 3/4 [19.05] 1 [25.4]	3/4 [19.05] 1 1/4 [31.75] 2 [50.8]
Class B Commercial appliances including business equipment, electronic data processing equipment and the like	51 - 150 151 - 300 251 - 600	1/16 [1.59] 3/32 [2.38] 3/8 [9.53]	1/16 [1.59] 3/32 [2.38] 1/2 [12.7]
Class C General industrial and machine tools; controls which can be further defined as equipment falling under UL508	51 - 150 151 - 300 301 - 600	1/8 [3.18] 1/4 [6.35] 3/8 [9.53]	1/4 [6.35] 3/8 [9.53] 1/2 [12.7]
Devices having limited ratings ^a	51 - 300 301 - 600	1/16 [1.59] 3/16 [4.76]	1/8 [3.18] 3/8 [9.53]

^aLoad on any single circuit can not exceed 15 A at 51-150 V, 10 A at 151-300 V, 5 A at 301-600 V or the maximum current rating, whichever is less.

Standard Test Criteria

Test	Per:
Heat Cycling (term)	UL486E Section 10
Static Heating (term)	UL486E Section 11
Secureness	UL486E Section 12
Pullout	UL486E Section 14
Heating Test (block)	UL1059 Section 10
Dielectric Withstand	UL1059 Section 11
Strength of Base	UL1059 Section 13
Tab Pull	UL1059 Section 14
VPTA	UL1059 Section 15
Salt Spray	MIL-202 Method 101
Solderability	MIL-202 Method 208
Solvents	MIL-202 Method 215

Note: All part numbers are RoHS Compliant.

All Tyco Electronic Part Numbers without a corresponding BUCHANAN Part Number are listed as base part numbers only. Complete part numbers (with prefixes and/or suffixes) are shown on the page(s) indicated.

Tyco Part Number	BUCHANAN Part Number	Page Number
— 01		153,154,170,172
— 02		153,154,170,172,173
— 03		153,154,172
— 04		153,170,172
— 05		153
— 06		154
— 07		154
— 08		154
— 09		154,172,173
— 17		172
— 18		172
— 20		154
— 21		154
— 22		154
— 23		154
— 25		154
— 26		154
— 28		154
— 29		154
— 30		154
— 31		154
— 33		154
— 34		154
— 35		154
— 36		154
— 37		154
— 38		154
— 39		154
— 40		154
— 41		154
— 42		154
— 44		154
— 45		154
— 46		154
— 47		154
— 48		154
— 49		154
— 50		154
— 51		154
— 53		154
— 54		154
— 55		154
— 80		154
— 115		294
— 1003SI		215
— 1003SI3DS		229
— 1003SI4DS		229
— 1003SI4E		229
— 1003SI4EDS		229
— 1003SI5DS		229
— 1003SI5E		229
— 1003SI5EDS		229
— 1500BZM		237
— 2EHDR		60,61
— 2ESDV		77
— 2M36TELPL		199
— 2M36TELPL		199
— 2PDT		207,210
— 2TK		206
— 2TK2		198,199,200,201, 202,203,205,211
— 2TK2D		198,199,200,201,202, 203,205,206,208,211
— 3PCV-03-006		120
— 3PCV-04-006		121
— 3PCV-10-006		120
— 500BZM		237
— 500SI		214
— 500SI10		234
— 500SI10K		234
— 500SI5		234
— 500SI5K		234
— 503SI		214
— 503SI4EDS		225
— 503SI5EDS		225
— 5ESDV		77
— 5KEV		12
— 5LEA		26
— 5LEEV		32
— 61500511A		293
— 6TK2		211
— 6TK2D		211
— ABK40502		235
— ABK40503		235
— ABK40504		235
— ABK40506		235
— ABK40512		235
— ABK40602		235
— ABK40603		235

Tyco Part Number	BUCHANAN Part Number	Page Number
— ABK40604		235
— ABK40606		235
— ABK40612		235
— ABK41502		235
— ABK41503		235
— ABK41504		235
— ABK41506		235
— ABK50302		235
— ABK50303		235
— ABK50304		235
— ABK50305		235
— ABK50312		235
— B024C4H		21
— B02C4V		12
— B03C5V		17
— B04C4V		26
— B07C4V		32
— B2EHDV		52
— B51C4		90
— B51C4U171		89
— B51C4U191		89
— B51C4U211		89
— B51C4U231		89
— B51C8		91
— B52C3U		76
— B52C4U		77
— B71N4		89
— B71N4V191T		90
— B71N4V211		90
— B71N4V231		90
— B71N8V131		92
— B71N8V151		92
— B71N8V191T		92
— B71N8V211		92
— B71N8V231		92
— B72N4H		59
— B72N4V		51
— B73N3H		58
— B73N3V		49
— B73N4H		60
— B73N4V		51
— BC6		174,177,178
— DP243		261
— J3 Series		120,124,143,145,177
— J4 Series		124,143,145,177
— J6 Series		128,134,147,156,171,177,194
— J8 Series		136,141,177
— JC6-P107-06		147
— M1000BZ02		237
— M1000BZ03		237
— M1000BZ04		237
— M1000BZ05		237
— M1000BZ06		237
— M1000BZ07		237
— M1000BZ09		237
— M1000BZ10		237
— M1000BZ11		237
— M1500BZ02		237
— M1500BZ03		237
— M1500BZ04		237
— M1500BZ05		237
— M1500BZ06		237
— M1500BZ07		237
— M1500BZ08		237
— M1500BZ09		237
— M1500BZ10		237
— M1500BZ11		237
— M1500BZ12		237
— M2000BZ02		237
— M2000BZ03		237
— M2000BZ04		237
— M2000BZ05		237
— M2000BZ06		237
— M2000BZ07		237
— M2000BZ08		237
— M2000BZ09		237
— M2000BZ10		237
— M2000BZ11		237
— M2000BZ12		237
— M230BZ02		237
— M230BZ05		237
— M230BZ06		237
— M230BZ07		237
— M230BZ08		237
— M230BZ11		237
— M5000513G		293
— M500BZ02		237
— M500BZ03		237
— M500BZ04		237
— M500BZ05		237
— M500BZ07		237
— M500BZ08		237
— M500BZ09		237
— M500BZ10		237
— M500BZ11		237

Tyco Part Number	BUCHANAN Part Number	Page Number
— PCB1B16S		183
— PCB1B24S		183
— PCB1B30S		183
— PCB2B		184
— PCB2B24S		184
— PCB2B32S		184
— PCB3J3		190
— PSB3KB08SNNNN		189
— PSB3KCC28		191
— QC1		169
— QC2		134,147,153
— QC4		134,143,147,153,176
— R10		207
— RB1		205,206
— RB4		207
— RB5		206
— RSB3		115,161,162,164,165, 166,175,178
— RSB3VP0212		162
— RSB3VP0312		162
— RSB3VP0412		162
— RSB3VP0512		162
— RSB3VP0612		162
— RSB3VP06120211		165
— RSB3VP0712		162
— RSB3VP0812		162
— RSB3VP0912		162
— RSB3VP1012		162
— RSB3VP1112		162
— RSB3VP1212		162
— RSB3VP1312		162
— RSB3VP1412		162
— RSB6		115,161,163,171,172, 173,175,177,178
— RSB6B		161,163
— RSB6RP07120211		172
— SPDT		209
— SSB3		115,161,162,166,168, 169,170,175,176,178
— SSB3FP		169
— SSB3FP0202		162
— SSB3FP0302		162
— SSB3FP0402		162
— SSB3FP0502		162
— SSB3FP0602		162
— SSB3FP06020211AA		116
— SSB3FP0702		162
— SSB3FP0802		162
— SSB3FP080202		162
— SSB3FP0902		162
— SSB3FP1002		162
— SSB3FP1102		162
— SSB3FP1202		162
— SSB3FP1302		162
— SSB3FP1402		162
— SSB7FP06020211		152
— TC4-06-PFH-CL		174
— TSB1000		235,237
— TSB1500		215,235,237
— TSB2000		215,237
— TSB200001KDS		233
— TSB230		214,237
— TSB500		214,216,221,222,223,225, 234,235,236,237,293
— TSB500SK		214,235
— USB3FP0202		162
— USB3FP0302		162
— USB3FP0402		162
— USB3FP0502		162
— USB3FP0602		162
— USB3FP0702		162
— USB3FP0802		162
— USB3FP0902		162
— USB3FP1002		162
— USB3FP1102		162
— USB3FP1202		162
— USB3FP1302		162
— USB3FP1402		162
— USB3VP0212		162
— USB3VP0312		162
— USB3VP0412		162
— USB3VP0512		162
— USB3VP0612		162
— USB3VP0712		162
— USB3VP0812		162
— USB3VP0912		162
— USB3VP1012		162
— USB3VP1112		162
— USB3VP1212		162
— USB3VP1312		162
— USB3VP1412		162
46121		109
47386		109
47387		109
59239		109

Note: All part numbers are RoHS Compliant.

Tyco Part Number	BUCHANAN Part Number	Page Number
160402	—	109
165046	—	109
165049	—	109
165075	—	109
165085	—	109
165142	—	109
165167	—	109
165168	—	109
165171	—	109
165172	—	109
165514	—	109
282805	—	81
282807	—	81
282808	—	79
282809	—	79
282811	—	66
282812	—	59
282814	—	66
282815	—	61
282816	—	64
282817	—	64
282818	—	65
282819	—	65
282821	—	57
282822	—	51
282824	—	57
282825	—	52
282826	—	55
282827	—	55
282828	—	56
282830	—	86
282831	—	88
282834	—	8
282835	—	8
282836	—	11
282837	—	11
282838	—	16
282839	—	18
282841	—	13
282842	—	17
282843	—	18
282844	—	14
282845	—	15
282847	—	26
282848	—	27
282849	—	27
282851	—	22
282852	—	24
282853	—	25
282854	—	23
282855	—	23
282856	—	12
282857	—	14
282858	—	17
282860	—	15
282861	—	16
282862	—	21
282863	—	22
282867	—	23
282868	—	32
282869	—	33
282873	—	34
282876	—	35
282877	—	36
282880	—	38
282881	—	39
282884	—	41
282888	—	32
282897	—	37
282900	—	38
282901	—	40
282905	—	42
282906	—	43
282909	—	34
282913	—	35
282916	—	36
282917	—	37
282920	—	39
282921	—	40
282924	—	41
282925	—	42
282928	—	107
282929	—	107
282930	—	107
282959	—	78
282961	—	62
282962	—	62
282963	—	53
282964	—	53
282965	—	63
282966	—	63
282967	—	54
282969	—	108
282970	—	108
284008	—	67

Tyco Part Number	BUCHANAN Part Number	Page Number
284040	—	82
284041	—	83
284042	—	84
284043	—	84
284044	—	84
284045	—	84
284046	—	82
284047	—	83
284049	—	84
284051	—	84
284052	—	70
284053	—	70
284056	—	68
284061	—	71
284065	—	68
284093	—	20
284094	—	21
284391	—	9
284392	—	10
284410	—	28
284414	—	19
284415	—	19
284506	—	76
284507	—	76
284509	—	80
284510	—	73
284511	—	73
284512	—	58
284513	—	58
284514	—	49
284515	—	49
284516	—	45
284517	—	50
284518	—	50
284519	—	45
284539	—	47
284541	—	47
284627	—	107
284628	—	107
346218	—	189
346220	—	188,190,193,194
347528	—	189
347529	—	189
347601	—	189
539660	—	111
539661	—	111
546211	—	51
785730	—	108
796634	—	77
796635	—	77
796636	—	52
796637	—	52
796638	—	61
796639	—	61
796640	—	77
796641	—	51,77
796642	—	51
796643	—	51
796644	—	60
796645	—	60
796681	—	12
796682	—	12
796683	—	12
796684	—	20
796688	—	26
796689	—	26
796690	—	26
796691	—	32
796692	—	33
796693	—	76
796694	—	49
796695	—	58
796696	—	77
796697	—	51
796698	—	59
796699	—	51
796700	—	60
796704	—	17
796739	—	29
796740	—	29
796741	—	30
796748	—	20
796858	—	74
796859	—	74
796861	—	75
796863	—	75
796864	—	48
796866	—	48
796867	—	46
796911	—	13
796949	—	13
796980	—	54
796981	—	78
796984	—	33
966067	—	110

Tyco Part Number	BUCHANAN Part Number	Page Number
966144	—	110
1241000	—	111
1241001	—	111
1241002	—	111
1241003	—	111
1241004	—	111
1437425	—	136,141
1437649	—	124,178
1437651	—	128,134,147,149,178
1437667	—	143,178
1447425	—	178
1447429	—	178
1546018	—	86
1546050	—	108
1546051	—	108
1546062	—	15
1546073	—	22
1546074	—	26
1546105	—	83
1546106	—	68
1546108	—	77
1546109	—	61
1546110	—	61
1546111	—	52
1546118	—	82
1546122	—	83
1546173	—	87
1546179	—	59
1546208	—	77
1546209	—	60
1546210	—	59
1546211	—	51
1546212	—	51
1546213	—	52
1546215	—	8
1546216	—	11
1546217	—	11
1546218	—	13
1546219	—	26
1546220	—	26
1546222	—	33
1546223	—	82
1546224	—	83
1546225	—	20
1546226	—	86
1546227	—	9
1546231	—	83
1546233	—	37
1546237	—	70
1546306	—	156
1546307	—	156
1546310	—	160
1546311	—	160
1546477	—	157
1546481	—	157
1546551	—	9
1546552	—	10
1546625	—	82
1546657	—	139,142
1546670	—	158,177
1546671	—	158,177
1546734	—	146
1546833	—	132
1546857	—	82
1546927	—	127
1546931	—	85,86,87
1546932	—	85,88
1546935	—	84
1776038	—	61
1776057	—	158,176
1776090	—	153,176
1776110	—	158
1776112	—	9,16
1776113	—	10
1776118	—	11
1776120	—	20
1776121	—	21
1776123	—	18
1776124	—	24
1776125	—	25
1776126	—	13
1776130	—	49
1776131	—	50
1776132	—	45
1776133	—	45
1776134	—	58
1776135	—	58
1776136	—	47
1776137	—	47
1776138	—	51
1776139	—	52
1776140	—	59
1776141	—	61
1776142	—	57
1776143	—	57

Note: All part numbers are RoHS Compliant.

Tyco Part Number	BUCHANAN Part Number	Page Number
1776144	—	66
1776145	—	66
1776146	—	51
1776147	—	52
1776148	—	60
1776149	—	53
1776150	—	54
1776152	—	63
1776153	—	53
1776154	—	54
1776155	—	63
1776156	—	55
1776157	—	56
1776158	—	64
1776159	—	65
1776160	—	55
1776161	—	56
1776162	—	64
1776163	—	65
1776164	—	68
1776165	—	68
1776166	—	71
1776167	—	71
1776168	—	69
1776169	—	69
1776170	—	72
1776171	—	72
1776173	—	159, 160, 176
1776174	—	159, 176
1776244	—	97
1776252	—	99
1776258	—	99
1776259	—	106
1776260	—	106
1776261	—	105
1776262	—	105
1776263	—	100
1776266	—	97
1776267	—	95
1776269	—	97
1776275	—	96
1776279	—	102
1776280	—	100
1776281	—	102
1776282	—	102
1776283	—	102
1776489	—	100
1776491	—	98
1776492	—	94
1776504	—	97
1776538	—	84
1776544	—	159
1776555	—	95
1776803	—	176
1776843	—	176
1776860	—	176
1776886	—	30
1811398	—	103
1811444	—	103
1811957	—	103
0-0796595-1	BC6-P108-06-284	134
0-0796595-2	BC6-P108-03-289	134
0-0796595-3	BC6-P108-03-290	134
0-0796595-4	BC6-P108-16-291	134
0-0796598-6	4WWW-24-008	125
0-0796598-7	4WWW-02-006	125
0-0796598-8	4WWW-04-006	125
0-0796598-9	4WWW-05-006	125
0-0796607-7	4PCV-02-511	125
0-0796607-8	4PCV-04-512	125
0-0796607-9	4PCV-06-513	125
0-0796608-2	6WWW-02-006	129
0-0796608-3	6WWW-07-006	129
0-0796608-4	6WWW-09-006	129
0-0796608-5	6WWW-11-006	129
0-0796608-6	6WWW-13-006	129
0-0796608-7	6WWW-14-006	129
0-0796608-8	6WWW-15-006	129
0-0796608-9	6WWW-16-006	129
0-0796612-2	6WWW-06-008	129
0-0796612-7	6WWW-07-006	129
0-0796612-8	6WWW-10-006	129
0-0796612-9	6WWW-11-006	129
0-0796905-1	6PCR-08-1383	129
0-0796905-2	6PCR-29-007	129
0-0796905-3	6PCR-30-007	129
0-0796907-1	6PCV-11-6176	129
0-0796968-3	BC6-W407-03	134
0-0796968-4	BC6-W407-04	134
0-0796985-1	JC6-1208-03	147
0-0796985-2	JC6-1207-06	147
0-0796985-3	JC6-P108-09	147
0-0796985-4	JC6-W107-10	147
0-0796985-5	JC6-W207-06	147
0-0796985-6	JC6-Q308-10	147

Tyco Part Number	BUCHANAN Part Number	Page Number
0-0796985-7	JC6-P107-13-150	147
0-0796985-8	JC6-P108-04-186	147
0-0796985-9	JC6-Q308-12	147
0-0796988-4	6PCR-20-006	129
0-0796988-7	6STR-07-008	129
0-0796988-8	6STR-04-006	129
0-0796989-1	6STV-06-727	129
0-1546045-2	6PCV-02-1286	129
0-1546045-3	6PCV-03-1287	129
0-1546045-4	6PCV-04-1288	129
0-1546045-5	6PCV-05-1289	129
0-1546045-6	6PCV-06-1290	129
0-1546045-7	6PCV-07-1291	129
0-1546045-8	6PCV-08-1292	129
0-1546045-9	6PCV-09-1293	129
0-1546159-3	6STV-04-1068	129
0-1546159-6	6STV-05-1059	129
0-1546174-2	6STR-09-006	129
0-1546174-3	6STR-10-006	129
0-1546174-4	6STR-11-006	129
0-1546174-5	6STR-12-006	129
0-1546174-6	6STR-14-006	129
0-1546174-7	6STR-15-006	129
0-1546174-8	6STR-16-006	129
0-1546174-9	6STR-17-006	129
0-1546242-4	6STR-04-008	129
0-1546262-5	6PCV-18-1390	129
0-1546277-1	6STV-04-008	129
0-1546277-2	6STV-09-006	129
0-1546277-3	6STV-11-006	129
0-1546277-4	6STV-13-006	129
0-1546277-5	6STV-14-006	129
0-1546277-6	6STV-16-006	129
0-1546277-7	6STV-17-006	129
0-1546277-8	6STV-18-006	129
0-1546277-9	6STV-19-006	129
0-1546283-1	4PCR-06-519	125
0-1546283-2	4PCR-06-517	125
0-1546283-3	4PCR-09-518	125
0-1546283-4	4PCR-11-006	125
0-1546283-5	4PCR-13-006	125
0-1546283-6	4PCR-14-006	125
0-1546283-7	4PCR-15-006	125
0-1546283-8	4PCR-16-006	125
0-1546283-9	4PCR-18-006	125
0-1546399-2	6PCR-13-006	129
0-1546399-3	6PCR-15-006	129
0-1546399-4	6PCR-16-006	129
0-1546399-5	6PCR-17-006	129
0-1546399-6	6PCR-19-006	129
0-1546399-7	6PCR-21-006	129
0-1546399-8	6PCR-22-006	129
0-1546399-9	6PCR-23-006	129
0-1546474-1	JC6-Q308-12-184	147
0-1546685-1	6DBL-08-006	129
0-1546685-2	6DBL-09-006	129
0-1546685-3	6DBL-10-006	129
0-1546685-4	6DBL-11-006	129
0-1546685-5	6DBL-13-006	129
0-1546685-6	6DBL-14-006	129
0-1546685-7	6DBL-15-006	129
0-1546685-8	6DBL-16-006	129
0-1546685-9	6DBL-17-006	129
0-1546686-1	6PCV-10-008	129
0-1546686-2	6PCV-14-008	129
0-1546686-3	6PCV-17-008	129
0-1546686-4	6PCV-19-008	129
0-1546686-5	6PCV-21-008	129
0-1546686-6	6PCV-22-008	129
0-1546686-7	6PCV-23-008	129
0-1546686-8	6PCV-24-008	129
0-1546686-9	6PCV-25-008	129
0-1546692-1	6TBV-02-006	129
0-1546692-2	6TBV-03-006	129
0-1546692-3	6TBV-05-006	129
0-1546692-4	6TBV-07-006	129
0-1546692-5	6TBV-11-006	129
0-1546692-6	6TBV-12-006	129
0-1546692-7	6TBV-13-006	129
0-1546692-8	6TBV-14-006	129
0-1546692-9	6TBV-15-006	129
0-1546700-1	JC6-Q307-11	147
0-1546700-2	JC6-Q307-13	147
0-1546700-3	JC6-Q307-14	147
0-1546700-4	JC6-Q307-17	147
0-1546700-5	JC6-Q307-19	147
0-1546700-6	JC6-Q307-20	147
0-1546700-7	JC6-Q307-21	147
0-1546700-8	JC6-Q307-22	147
0-1546700-9	JC6-Q307-23	147
0-1546701-2	JC6-1307-13	147
0-1546701-3	JC6-1307-14	147
0-1546701-4	JC6-1307-15	147
0-1546701-5	JC6-1307-16	147
0-1546701-6	JC6-1307-11	147

Tyco Part Number	BUCHANAN Part Number	Page Number
0-1546701-7	JC6-T307-17	147
0-1546701-8	JC6-T307-19	147
0-1546701-9	JC6-T307-20	147
0-1546702-1	JC6-W408-02	147
0-1546702-2	JC6-W408-05	147
0-1546702-3	JC6-W408-06	147
0-1546702-4	JC6-W408-07	147
0-1546702-5	JC6-W408-08	147
0-1546702-6	JC6-W408-09	147
0-1546702-7	JC6-W408-10	147
0-1546702-8	JC6-W408-11	147
0-1546702-9	JC6-W408-13	147
0-1546703-1	JC6-W207-03	147
0-1546703-2	JC6-W207-04	147
0-1546703-3	JC6-W207-07	147
0-1546703-4	JC6-W207-08	147
0-1546703-5	JC6-W207-09	147
0-1546703-6	JC6-W207-10	147
0-1546703-7	JC6-W207-11	147
0-1546703-8	JC6-W207-12	147
0-1546703-9	JC6-W207-13	147
0-1546718-2	JC6-C707-02	147
0-1546718-3	JC6-C707-03	147
0-1546718-4	JC6-C707-04	147
0-1546718-5	JC6-C707-05	147
0-1546718-6	JC6-C707-06	147
0-1546718-7	JC6-C707-07	147
0-1546718-8	JC6-C707-08	147
0-1546718-9	JC6-C707-09	147
0-1546719-2	JC6-C708-02	147
0-1546719-3	JC6-C708-03	147
0-1546719-4	JC6-C708-04	147
0-1546719-5	JC6-C708-05	147
0-1546719-6	JC6-C708-06	147
0-1546719-7	JC6-C708-07	147
0-1546719-8	JC6-C708-08	147
0-1546719-9	JC6-C708-09	147
0-1546720-2	JC6-E107-02	147
0-1546720-3	JC6-E107-03	147
0-1546720-4	JC6-E107-04	147
0-1546720-5	JC6-E107-05	147
0-1546720-6	JC6-E107-06	147
0-1546720-7	JC6-E107-07	147
0-1546720-8	JC6-E107-08	147
0-1546720-9	JC6-E107-09	147
0-1546721-2	JC6-E108-02	147
0-1546721-3	JC6-E108-03	147
0-1546721-4	JC6-E108-04	147
0-1546721-5	JC6-E108-05	147
0-1546721-6	JC6-E108-06	147
0-1546721-7	JC6-E108-07	147
0-1546721-8	JC6-E108-08	147
0-1546721-9	JC6-E108-09	147
0-1546722-2	JC6-E207-02	147
0-1546722-3	JC6-E207-03	147
0-1546722-4	JC6-E207-04	147
0-1546722-5	JC6-E207-05	147
0-1546722-6	JC6-E207-06	147
0-1546722-7	JC6-E207-07	147
0-1546722-8	JC6-E207-08	147
0-1546722-9	JC6-E207-09	147
0-1546723-2	JC6-E208-02	147
0-1546723-3	JC6-E208-03	147
0-1546723-4	JC6-E208-04	147
0-1546723-5	JC6-E208-05	147
0-1546723-6	JC6-E208-06	147
0-1546723-7	JC6-E208-07	147
0-1546723-8	JC6-E208-08	147
0-1546723-9	JC6-E208-09	147
0-1546724-2	JC6-E307-02	147
0-1546724-3	JC6-E307-03	147
0-1546724-4	JC6-E307-04	147
0-1546724-5	JC6-E307-05	147
0-1546724-6	JC6-E307-06	147
0-1546724-7	JC6-E307-07	147
0-1546724-8	JC6-E307-08	147
0-1546724-9	JC6-E307-09	147
0-1546725-2	JC6-E308-02	147
0-1546725-3	JC6-E308-03	147
0-1546725-4	JC6-E308-04	147
0-1546725-5	JC6-E308-05	147
0-1546725-6	JC6-E308-06	147
0-1546725-7	JC6-E308-07	147
0-1546725-8	JC6-E308-08	147
0-1546725-9	JC6-E308-09	147
0-1546726-2	JC6-E407-02	147
0-1546726-3	JC6-E407-03	147
0-1546726-4	JC6-E407-04	147
0-1546726-5	JC6-E407-05	147
0-1546726-6	JC6-E407-06	147
0-1546726-7	JC6-E407-07	147
0-1546726-8	JC6-E407-08	147
0-1546726-9	JC6-E407-09	147
0-1546727-2	JC6-E408-02	147
0-1546727-3	JC6-E408-03	147

Note: All part numbers are RoHS Compliant.

Tyco Part Number	BUCHANAN Part Number	Page Number
0-1546727-4	JC6-E408-04	147
0-1546727-5	JC6-E408-05	147
0-1546727-6	JC6-E408-06	147
0-1546727-7	JC6-E408-07	147
0-1546727-8	JC6-E408-08	147
0-1546727-9	JC6-E408-09	147
0-1546751-1	JC6-W405-16	147
0-1546751-2	JC6-W407-08-228	147
0-1546752-1	JC6-W208-04-183	147
0-1546752-2	JC6-W208-09-223	147
0-1546781-1	BC6-Q308-04	134
0-1546781-2	BC6-Q308-05	134
0-1546781-3	BC6-Q308-07	134
0-1546781-4	BC6-Q308-08	134
0-1546781-5	BC6-Q308-09	134
0-1546781-6	BC6-Q308-11	134
0-1546781-7	BC6-Q308-12	134
0-1546781-8	BC6-Q308-14	134
0-1546781-9	BC6-Q308-16	134
0-1546783-1	BC6-Q608-02	134
0-1546783-2	BC6-Q608-04	134
0-1546783-3	BC6-Q608-07	134
0-1546783-4	BC6-Q608-08	134
0-1546783-5	BC6-Q608-09	134
0-1546783-6	BC6-Q608-11	134
0-1546783-7	BC6-Q608-12	134
0-1546783-8	BC6-Q608-13	134
0-1546783-9	BC6-Q608-14	134
0-1546784-1	BC6-W408-02	134
0-1546784-2	BC6-W408-05	134
0-1546784-3	BC6-W408-07	134
0-1546784-4	BC6-W408-09	134
0-1546784-5	BC6-W408-11	134
0-1546784-6	BC6-W408-12	134
0-1546784-7	BC6-W408-14	134
0-1546784-8	BC6-W408-15	134
0-1546784-9	BC6-W408-16	134
0-1546787-1	JC6-P108-04-186	147
0-1546814-1	6PCV-29-007	129
0-1546815-1	6WWR-29-006	129
0-1546815-2	6WWR-30-006	129
0-1546816-1	6STR-29-006	129
0-1546816-2	6STR-30-006	129
0-1546817-1	6PCR-29-006	129
0-1546817-2	6PCR-30-006	129
0-1546820-2	6STV-02-008	129
0-1546820-5	6STV-05-008	129
0-1546820-7	6STV-07-008	129
0-1546820-8	6STV-08-008	129
0-1546820-9	6STV-09-008	129
0-1546821-5	6DBL-05-007	129
0-1546821-6	6DBL-06-007	129
0-1546821-7	6DBL-07-007	129
0-1546821-8	6DBL-08-007	129
0-1546821-9	6DBL-09-007	129
0-1546840-6	JC6-T208-06	147
0-1546840-7	JC6-T208-07	147
0-1546840-8	JC6-T208-08	147
0-1546840-9	JC6-T208-09	147
0-1546841-2	JC6-Q207-02	147
0-1546841-5	JC6-Q207-05	147
0-1546841-6	JC6-Q207-06	147
0-1546841-7	JC6-Q207-07	147
0-1546841-8	JC6-Q207-08	147
0-1546841-9	JC6-Q207-09	147
0-1546842-2	JC6-Q208-02	147
0-1546842-4	JC6-Q208-04	147
0-1546842-5	JC6-Q208-05	147
0-1546842-6	JC6-Q208-06	147
0-1546842-7	JC6-Q208-07	147
0-1546842-8	JC6-Q208-08	147
0-1546842-9	JC6-Q208-09	147
0-1546865-2	BC6-T308-02	134
0-1546865-4	BC6-T308-04	134
0-1546865-5	BC6-T308-05	134
0-1546865-6	BC6-T308-06	134
0-1546865-8	BC6-T308-08	134
0-1546865-9	BC6-T308-09	134
0-1546866-2	BC6-P107-02	134
0-1546866-3	BC6-P107-03	134
0-1546866-5	BC6-P107-05	134
0-1546866-6	BC6-P107-06	134
0-1546866-7	BC6-P107-07	134
0-1546866-9	BC6-P107-09	134
0-1546867-2	BC6-Q408-02	134
0-1546867-4	BC6-Q408-04	134
0-1546867-9	BC6-Q408-09	134
0-1546868-2	BC6-Q108-02	134
0-1546868-4	BC6-Q108-04	134
0-1546937-1	4DBL-05-006	125
0-1546937-2	4DBL-06-006	125
0-1546937-3	4DBL-07-006	125
0-1546937-4	4DBL-08-006	125
0-1546937-5	4DBL-09-006	125
0-1546937-6	4DBL-10-006	125

Tyco Part Number	BUCHANAN Part Number	Page Number
0-1546937-7	4DBL-11-006	125
0-1546937-8	4DBL-13-006	125
0-1546937-9	4DBL-14-006	125
0-1546939-1	4PCV-12-008	125
0-1546939-2	4PCV-13-008	125
0-1546939-3	4PCV-14-008	125
0-1546939-4	4PCV-16-008	125
0-1546939-5	4PCV-17-008	125
0-1546939-6	4PCV-18-008	125
0-1546939-7	4PCV-19-008	125
0-1546939-8	4PCV-20-008	125
0-1546939-9	4PCV-21-008	125
0-1546940-1	4PCR-02-008	125
0-1546940-2	4PCR-03-008	125
0-1546940-3	4PCR-05-008	125
0-1546940-4	4PCR-06-008	125
0-1546940-5	4PCR-07-008	125
0-1546940-6	4PCR-08-008	125
0-1546940-7	4PCR-09-008	125
0-1546940-8	4PCR-10-008	125
0-1546940-9	4PCR-11-008	125
0-1546942-2	BC6-P508-02	134
0-1546942-4	BC6-P508-04	134
0-1546942-5	BC6-P508-05	134
0-1546942-6	BC6-P508-06	134
0-1546942-7	BC6-P508-07	134
0-1546942-8	BC6-P508-08	134
0-1546942-9	BC6-P508-09	134
0-1546961-2	BC6-W308-02	134
0-1776006-1	JC6-T307-12-191	147
0-1776006-2	JC6-T307-09-192	147
0-1776006-3	JC6-T307-14-193	147
0-1776006-4	JC6-T305-07-219	147
0-1776006-5	JC6-T305-20	147
0-1776007-1	JC6-Q307-05-194	147
0-1776007-2	JC6-Q307-14-195	147
0-1776007-3	JC6-Q307-08-196	147
0-1776007-4	JC6-Q307-16-197	147
0-1776007-5	JC6-Q307-06-203	147
0-1776007-6	JC6-Q307-06-206	147
0-1776007-7	JC6-Q307-18-225	147
0-1776007-8	JC6-Q307-22-226	147
0-1776007-9	JC6-Q305-04	147
0-1776008-3	BC6-W308-03	134
0-1776008-4	BC6-W308-04	134
0-1776008-5	BC6-W308-05	134
0-1776008-6	BC6-W308-06	134
0-1776008-7	BC6-W308-07	134
0-1776008-8	BC6-W308-08	134
0-1776008-9	BC6-W308-09	134
0-1776037-2	6STR-02-009	129
0-1776037-3	6STR-03-009	129
0-1776037-4	6STR-04-009	129
0-1776037-5	6STR-05-009	129
0-1776037-6	6STR-06-009	129
0-1776037-7	6STR-07-009	129
0-1776037-8	6STR-08-009	129
0-1776037-9	6STR-09-009	129
0-1776097-4	4PCV-04-007	125
0-1776100-2	BC6-W108-02	134
0-1776100-3	BC6-W108-03	134
0-1776100-4	BC6-W108-04	134
0-1776100-5	BC6-W108-05	134
0-1776100-6	BC6-W108-06	134
0-1776100-7	BC6-W108-07	134
0-1776100-8	BC6-W108-08	134
0-1776175-1	JC6-W108-12-198	147
0-1776175-2	JC6-W108-05-199	147
0-1776175-3	JC6-W108-06-200	147
0-1776175-4	JC6-W108-08-201	147
0-1776175-5	JC6-W108-03-231	147
0-1776175-6	JC6-W108-06-234	147
0-1776228-1	JC6-W107-04-202	147
0-1776228-2	JC6-W107-03-233	147
0-1776249-1	JC6-P106-05	147
0-1776249-2	JC6-P106-07	147
0-1776249-3	JC6-P106-08	147
0-1776249-4	JC6-P106-03	147
0-1776249-5	JC6-P106-04	147
0-1776249-6	JC6-P106-06	147
0-1776249-7	JC6-P106-09	147
0-1776249-8	JC6-P106-12	147
0-1776249-9	JC6-P108-03-229	147
0-1776325-2	6STV-02-007	129
0-1776325-3	6STV-03-007	129
0-1776325-4	6STV-04-007	129
0-1776325-6	6STV-06-007	129
0-1776325-7	6STV-07-007	129
0-1776325-8	6STV-08-007	129
0-1776325-9	6STV-09-007	129
0-1776344-1	JC6-P208-22-224	147
0-1776345-1	JC6-W207-04-227	147
0-1776346-1	JC6-P105-25	147
0-1776346-2	JC6-P107-06-220	147
0-1776501-1	JC6-Q308-12-232	147

Tyco Part Number	BUCHANAN Part Number	Page Number
1-0796598-0	4WWW-06-006	125
1-0796598-1	4WWW-07-006	125
1-0796598-2	4WWW-09-006	125
1-0796598-3	4WWW-10-006	125
1-0796598-4	4WWW-13-006	125
1-0796598-5	4WWW-14-006	125
1-0796598-6	4WWW-15-006	125
1-0796598-7	4WWW-16-006	125
1-0796598-8	4WWW-17-006	125
1-0796598-9	4WWW-18-006	125
1-0796607-0	4PCV-02-514	125
1-0796607-1	4PCV-03-515	125
1-0796607-2	4PCV-21-006	125
1-0796607-3	4PCV-26-006	125
1-0796607-4	4PCV-28-006	125
1-0796607-5	4PCV-29-006	125
1-0796607-6	4PCV-05-520	125
1-0796607-7	4PCV-03-521	125
1-0796607-8	4PCV-04-522	125
1-0796607-9	4PCV-06-523	125
1-0796608-0	6WWW-17-006	129
1-0796608-1	6WWW-18-006	129
1-0796608-2	6WWW-19-006	129
1-0796608-3	6WWW-21-006	129
1-0796608-4	6WWW-23-006	129
1-0796608-5	6WWW-24-006	129
1-0796608-6	6WWW-25-006	129
1-0796608-7	6WWW-26-006	129
1-0796608-8	6WWW-27-006	129
1-0796608-9	6WWW-28-006	129
1-0796612-0	6WWR-12-006	129
1-0796612-1	6WWR-13-006	129
1-0796612-2	6WWR-14-006	129
1-0796612-3	6WWR-15-006	129
1-0796612-4	6WWR-16-006	129
1-0796612-5	6WWR-17-006	129
1-0796612-6	6WWR-18-006	129
1-0796612-7	6WWR-19-006	129
1-0796612-8	6WWR-20-006	129
1-0796612-9	6WWR-21-006	129
1-0796985-1	JC6-P107-06-166	147
1-0796985-2	JC6-P108-04-167	147
1-0796985-4	JC6-P108-06-169	147
1-0796985-5	JC6-P108-11-170	147
1-0796985-6	JC6-P108-21	147
1-0796985-8	JC6-P208-03-172	147
1-0796985-9	JC6-P208-15	147
1-0796988-0	6STV-06-006	129
1-0796988-2	6PCV-06-008	129
1-0796988-5	4WWW-12-006	125
1-1433794-1	0724ERT	252
1-1437381-0	13	154,169,172,247
1-1437381-1	14	154,169,172,247
1-1437381-2	15	154,169,172,247
1-1437381-3	16	154,169,172,247
1-1437381-5	228-BU	268
1-1437381-7	230-BU	268,269
1-1437381-8	24	154
1-1437381-9	27	154
1-1437382-2	71	254
1-1437382-3	73	254
1-1437382-4	74	254
1-1437382-5	75	262
1-1437382-6	76	275
1-1437382-6	23-BU	262,270
1-1437382-7	78-TB	254
1-1437382-8	7B102	290
1-1437382-9	7B102N	290
1-1437383-1	N104	291
1-1437383-2	N106	291
1-1437383-3	N108	291
1-1437383-4	N112	291
1-1437383-5	S102	291
1-1437383-6	S104	291
1-1437383-7	S106	291
1-1437383-8	S108	291
1-1437383-9	S112	291
1-1437387-5	M230BZ03	237
1-1437387-6	M230BZ04	237
1-1437387-7	M230BZ09	237
1-1437387-8	M230BZ10	237
1-1437387-9	M230BZ12	237
1-1437389-0	D0243	261
1-1437389-1	D0311	282
1-1437389-2	D0312	282
1-1437389-7	D0371	282
1-1437390-2	223	268
1-1437		

Note: All part numbers are RoHS Compliant.

Tyco Part Number	BUCHANAN Part Number	Page Number
1-1437397-2	358	286
1-1437397-4	361	294
1-1437397-5	362	286
1-1437397-6	368	286
1-1437397-6	368	294
1-1437397-7	371	282
1-1437397-8	372	283,294
1-1437397-9	378	283,294
1-1437401-1	SSB3FP020201	162
1-1437401-2	SSB3FP02020111	162
1-1437401-3	SSB3FP020202	162
1-1437401-4	SSB3FP020401	162
1-1437401-5	SSB3FP030201	162
1-1437401-6	SSB3FP030202	162
1-1437401-7	SSB3FP030402	162
1-1437401-8	SSB3FP030702	162
1-1437401-9	SSB3FP03070211	162
1-1437403-1	ST80	128,134,153,176,194
1-1437404-5	RSB3VP021201	162
1-1437404-6	RSB3VP021202	162
1-1437404-7	RSB3VP02120222	162
1-1437404-8	RSB3VP031201N	162
1-1437404-9	RSB3VP031202	162
1-1437406-5	PSB3KC06S	189
1-1437406-6	PSB3KC06SNN26	189
1-1437406-7	PSB3KC08A	189
1-1437406-8	PSB3KC08S	189
1-1437406-9	PSB3KC08SNN26	189
1-1437408-0	RSB6VP131202	172
1-1437408-1	RSB6VP131203NN60	172
1-1437408-2	RSB6VP141202	172
1-1437408-3	RSB6VP151201	172
1-1437408-4	RSB6VP151202	172
1-1437408-5	RSB6VP151203	172
1-1437408-6	RSB6VP161202	172
1-1437409-0	PSB3KCC18	191
1-1437409-1	PSB3KCC24	191
1-1437409-2	PSB3KCC26	191
1-1437409-3	PSB3KCC20	191
1-1437409-4	PSB3KCC06	191
1-1437410-0	PCB1A18A	182
1-1437410-1	PCB1A18S	182
1-1437410-2	PCB1A24A	182
1-1437410-3	PCB1A24S	182
1-1437410-4	PCB1A30A	182
1-1437410-5	PCB1A30S	182
1-1437410-6	PCB1A36A	182
1-1437410-7	PCB1A36S	182
1-1437410-8	PCB1B06S	183
1-1437410-9	PCB1B08AG	183
1-1437411-0	PCB3A32S	185
1-1437411-1	PCB3A36A	185
1-1437411-3	PCB3A36S	185
1-1437411-4	PCB3A44A	185
1-1437411-5	PCB3A44S	185
1-1437411-6	PCB3D20A	187
1-1437411-7	PCB3D20S	187
1-1437411-8	PCB3D30A	187
1-1437411-9	PCB3D30S	187
1-1437416-0	SSB7FP040200	152
1-1437416-1	SSB7FP040201	152
1-1437416-2	SSB7FP040202	152
1-1437416-4	SSB7FP040401	152
1-1437416-5	SSB7FP050201	152
1-1437416-6	SSB7FP05020111	152
1-1437416-7	SSB7FP050202	152
1-1437416-8	SSB7FP050203	152
1-1437416-9	SSB7FP050402	152
1-1437417-0	SSB7TP030404	152
1-1437417-1	SSB7TP050101	152
1-1437417-2	SSB7TP060402	152
1-1437417-3	SSB7TP060701	152
1-1437417-4	SSB7TP070701	152
1-1437417-5	SSB7TP070703	152
1-1437417-6	SSB7TP090402	152
1-1437417-7	SSB7TP100401	152
1-1437417-8	SSB7TP120501	152
1-1437417-9	SSB7TP130701	152
1-1437426-3	B51C4U05T	89
1-1437426-6	B51C4U06T	89
1-1437638-9	61BS	209
1-1437645-0	TC6-05	174
1-1437645-1	TC4-06	174
1-1437645-2	TC4-28	174
1-1437645-3	TC6-03	174
1-1437645-4	TC8-02-AG	174
1-1437645-5	TC8-03-AG	174
1-1437645-6	TC8-06-AG	174
1-1437645-7	TC4-18	174
1-1437645-9	TC4-03	174
1-1437656-0	J3-3	177
1-1437661-0	TC4-03-PFH	174
1-1437661-2	TC4-03-PFH	174
1-1437661-3	TC4-04-PFH	174
1-1437661-4	TC4-04-PFH	174

Tyco Part Number	BUCHANAN Part Number	Page Number
1-1437661-5	TC4-05-PFH	174
1-1437661-6	TC4-05-PFH	174
1-1437661-7	TC4-06-PFH	174
1-1437661-8	TC4-06-PFH	174
1-1437661-9	TC4-07-PFH	174
1-1437662-2	BC6-P108-08	134
1-1437664-0	NC6-P107-07	149
1-1437664-1	NC6-P107-08	149
1-1437664-3	NC6-P107-09	149
1-1437664-4	NC6-P107-10	149
1-1437664-6	NC6-P107-11	149
1-1437664-7	NC6-P107-12	149
1-1437664-8	NC6-P107-13	149
1-1437667-0	4DB-P107-04	143
1-1437667-1	4DB-P107-05	143
1-1437667-2	4DB-P107-06	143
1-1437667-4	4DB-P107-07	143
1-1437667-5	4DB-P107-08	143
1-1437667-6	4DB-P107-09	143
1-1437667-7	4DB-P107-10	143
1-1437667-8	4DB-P107-11	143
1-1437667-9	4DB-P107-12	143
1-1437671-0	2SV-07	104
1-1437671-1	2SV-08	104
1-1437671-2	2SV-09	104
1-1437671-3	2SV-10	104
1-1437671-4	2SV-11	104
1-1437671-5	2SV-12	104
1-1437671-6	2SV-13	104
1-1437671-9	2SV-14	104
1-1437683-0	218BR	205
1-1437683-1	21S-SOCKET	210
1-1437683-2	311BR	206
1-1437683-3	314BS	208
1-1437683-4	318BR	205
1-1437683-6	608BR	205
1-1437683-7	608BS	209
1-1437683-8	611BR	206
1-1437684-0	2M16DPZ	202
1-1437684-1	2M16FC	200
1-1437684-2	2M20FC	200
1-1437684-3	2M22PCB	203,204
1-1437684-4	2M24DP	202
1-1437684-5	2M24DPZ	202
1-1437684-7	2M25DSF	200
1-1437684-8	2M25DSM	200
1-1437684-9	2M26FC	201
1-1437685-0	2TK2-3	211
1-1437685-3	2TK2-48	211
1-1437685-4	2TK2-6	211
1-1437685-6	2TK2D-12	211
1-1437685-7	2TK2D-24	211
1-1437685-8	2TK2D-4	211
1-1437685-9	2TK2D-48	211
1-1546045-0	6PCV-10-1294	129
1-1546045-1	6PCV-11-1295	129
1-1546159-6	6WVR-03-693	129
1-1546160-6	6PCV-12-1296	129
1-1546160-7	6PCV-13-1297	129
1-1546160-8	6PCV-15-1298	129
1-1546174-0	6STR-18-006	129
1-1546174-1	6STR-19-006	129
1-1546174-2	6STR-20-006	129
1-1546174-3	6STR-21-006	129
1-1546174-4	6STR-22-006	129
1-1546174-5	6STR-23-006	129
1-1546174-6	6STR-24-006	129
1-1546174-7	6STR-26-006	129
1-1546174-9	6STR-27-006	129
1-1546242-1	6STR-11-008	129
1-1546277-0	6STV-20-006	129
1-1546277-1	6STV-21-006	129
1-1546277-2	6STV-22-006	129
1-1546277-3	6STV-23-006	129
1-1546277-4	6STV-24-006	129
1-1546277-5	6STV-25-006	129
1-1546277-6	6STV-26-006	129
1-1546277-7	6STV-27-006	129
1-1546277-8	6STV-28-006	129
1-1546283-0	4PCR-19-006	125
1-1546283-1	4PCR-20-006	125
1-1546283-2	4PCR-21-006	125
1-1546283-3	4PCR-22-006	125
1-1546283-4	4PCR-25-006	125
1-1546283-5	4PCR-26-006	125
1-1546283-6	4PCR-27-006	125
1-1546283-7	4PCR-29-006	125
1-1546283-8	4PCR-30-006	125
1-1546399-0	6PCR-25-006	129
1-1546399-1	6PCR-26-006	129
1-1546399-2	6PCR-27-006	129
1-1546399-3	6PCR-28-006	129
1-1546399-4	6PCR-05-007	129
1-1546399-5	6PCR-09-007	129

Tyco Part Number	BUCHANAN Part Number	Page Number
1-1546399-6	6PCR-10-007	129
1-1546399-7	6PCR-11-007	129
1-1546399-8	6PCR-13-007	129
1-1546399-9	6PCR-14-007	129
1-1546561-0	SSB7TG160101	152
1-1546561-1	SSB7TG200101	152
1-1546561-2	SSB7FP110202	152
1-1546561-3	SSB7CF030304	152
1-1546561-4	SSB7TF050501	152
1-1546561-5	SSB7CG11030229	152
1-1546561-6	SSB7CG110329	152
1-1546561-7	SSB7FF04070211	152
1-1546561-8	SSB7FP260203	152
1-1546561-9	SSB7FP090203	152
1-1546685-0	6DBL-18-006	129
1-1546685-1	6DBL-19-006	129
1-1546685-2	6DBL-20-006	129
1-1546685-3	6DBL-21-006	129
1-1546685-4	6DBL-22-006	129
1-1546685-5	6DBL-23-006	129
1-1546685-6	6DBL-24-006	129
1-1546685-7	6DBL-25-006	129
1-1546685-8	6DBL-26-006	129
1-1546685-9	6DBL-27-006	129
1-1546686-0	6PCV-26-008	129
1-1546686-1	6PCV-27-008	129
1-1546686-2	6PCV-28-008	129
1-1546686-3	6PCV-11-007	129
1-1546686-4	6PCV-17-007	129
1-1546686-5	6PCV-19-007	129
1-1546686-6	6PCV-21-007	129
1-1546686-7	6PCV-22-007	129
1-1546686-8	6PCV-23-007	129
1-1546686-9	6PCV-25-007	129
1-1546692-0	6TBV-16-006	129
1-1546692-1	6TBV-17-006	129
1-1546692-2	6TBV-18-006	129
1-1546692-3	6TBV-19-006	129
1-1546692-4	6TBV-20-006	129
1-1546692-5	6TBV-21-006	129
1-1546692-6	6TBV-22-006	129
1-1546692-7	6TBV-23-006	129
1-1546692-8	6TBV-24-006	129
1-1546692-9	6TBV-25-006	129
1-1546700-0	JC6-Q308-09	147
1-1546700-1	JC6-Q308-11	147
1-1546700-2	JC6-Q308-13	147
1-1546700-3	JC6-Q308-14	147
1-1546700-4	JC6-Q308-15	147
1-1546700-5	JC6-Q308-16	147
1-1546700-6	JC6-Q308-17	147
1-1546700-7	JC6-Q308-18	147
1-1546700-8	JC6-Q308-19	147
1-1546700-9	JC6-Q308-20	147
1-1546701-0	JC6-T307-21	147
1-1546701-1	JC6-T307-22	147
1-1546701-2	JC6-T307-23	147
1-1546701-3	JC6-T207-07	147
1-1546701-4	JC6-T207-09	147
1-1546701-5	JC6-T207-11	147
1-1546701-6	JC6-T207-12	147
1-1546701-7	JC6-T207-13	147
1-1546701-8	JC6-T207-14	147
1-1546701-9	JC6-T207-15	147
1-1546702-0	JC6-W408-14	147
1-1546702-1	JC6-W408-15	147
1-1546702-2	JC6-W408-16	147
1-1546702-3	JC6-W408-17	147
1-1546702-4	JC6-W408-18	147
1-1546702-5	JC6-W408-19	147
1-1546702-6	JC6-W408-20	147
1-1546702-7	JC6-W408-21	147
1-1546702-8	JC6-W408-22	147
1-1546702-9	JC6-W408-23	147
1-1546703-0	JC6-W207-14	147
1-1546703-1	JC6-W207-15	147
1-1546703-2	JC6-W207-16	147
1-1546703-3	JC6-W207-17	147
1-1546703-4	JC6-W207-18	147
1-1546703-5	JC6-W207-19	147
1-1546703-6	JC6-W207-20	147
1-1546703-7	JC6-W207-21	147
1-1546703-8	JC6-W207-22	147
1-1546703-9	JC6-W207-23	147
1-1546718-0	JC6-C707-10	147
1-1546718-1	JC6-C707-11	147
1-1546718-2	JC6-C707-12	147
1-1546718-3	JC6-C707-13	147
1-1546718-4	JC6-C707-14	147
1-1546718-5	JC6-C707-15	147
1-1546718-6	JC6-C707-16	147
1-1546718-7	JC6-C707-17	147
1-1546718-8	JC6-C707-18	147
1-1546718-9		

Note: All part numbers are RoHS Compliant.

Tyco Part Number	BUCHANAN Part Number	Page Number
1-1546719-1	JC6-C708-11	147
1-1546719-2	JC6-C708-12	147
1-1546719-3	JC6-C708-13	147
1-1546719-4	JC6-C708-14	147
1-1546719-5	JC6-C708-15	147
1-1546719-6	JC6-C708-16	147
1-1546719-7	JC6-C708-17	147
1-1546719-8	JC6-C708-18	147
1-1546719-9	JC6-C708-19	147
1-1546720-0	JC6-E107-10	147
1-1546720-1	JC6-E107-11	147
1-1546720-2	JC6-E107-12	147
1-1546720-3	JC6-E107-13	147
1-1546720-4	JC6-E107-14	147
1-1546720-5	JC6-E107-15	147
1-1546720-6	JC6-E107-16	147
1-1546720-7	JC6-E107-17	147
1-1546720-8	JC6-E107-18	147
1-1546720-9	JC6-E107-19	147
1-1546721-0	JC6-E108-10	147
1-1546721-1	JC6-E108-11	147
1-1546721-2	JC6-E108-12	147
1-1546721-3	JC6-E108-13	147
1-1546721-4	JC6-E108-14	147
1-1546721-5	JC6-E108-15	147
1-1546721-6	JC6-E108-16	147
1-1546721-7	JC6-E108-17	147
1-1546721-8	JC6-E108-18	147
1-1546721-9	JC6-E108-19	147
1-1546722-0	JC6-E207-10	147
1-1546722-1	JC6-E207-11	147
1-1546722-2	JC6-E207-12	147
1-1546722-3	JC6-E207-13	147
1-1546722-4	JC6-E207-14	147
1-1546722-5	JC6-E207-15	147
1-1546722-6	JC6-E207-16	147
1-1546722-7	JC6-E207-17	147
1-1546722-8	JC6-E207-18	147
1-1546722-9	JC6-E207-19	147
1-1546723-0	JC6-E208-10	147
1-1546723-1	JC6-E208-11	147
1-1546723-2	JC6-E208-12	147
1-1546723-3	JC6-E208-13	147
1-1546723-4	JC6-E208-14	147
1-1546723-5	JC6-E208-15	147
1-1546723-6	JC6-E208-16	147
1-1546723-7	JC6-E208-17	147
1-1546723-8	JC6-E208-18	147
1-1546723-9	JC6-E208-19	147
1-1546724-0	JC6-E307-10	147
1-1546724-1	JC6-E307-11	147
1-1546724-2	JC6-E307-12	147
1-1546724-3	JC6-E307-13	147
1-1546724-4	JC6-E307-14	147
1-1546724-5	JC6-E307-15	147
1-1546724-6	JC6-E307-16	147
1-1546724-7	JC6-E307-17	147
1-1546724-8	JC6-E307-18	147
1-1546724-9	JC6-E307-19	147
1-1546725-0	JC6-E308-10	147
1-1546725-1	JC6-E308-11	147
1-1546725-2	JC6-E308-12	147
1-1546725-3	JC6-E308-13	147
1-1546725-4	JC6-E308-14	147
1-1546725-5	JC6-E308-15	147
1-1546725-6	JC6-E308-16	147
1-1546725-7	JC6-E308-17	147
1-1546725-8	JC6-E308-18	147
1-1546725-9	JC6-E308-19	147
1-1546726-0	JC6-E407-10	147
1-1546726-1	JC6-E407-11	147
1-1546726-2	JC6-E407-12	147
1-1546726-3	JC6-E407-13	147
1-1546726-4	JC6-E407-14	147
1-1546726-5	JC6-E407-15	147
1-1546726-6	JC6-E407-16	147
1-1546726-7	JC6-E407-17	147
1-1546726-8	JC6-E407-18	147
1-1546726-9	JC6-E407-19	147
1-1546727-0	JC6-E408-10	147
1-1546727-1	JC6-E408-11	147
1-1546727-2	JC6-E408-12	147
1-1546727-3	JC6-E408-13	147
1-1546727-4	JC6-E408-14	147
1-1546727-5	JC6-E408-15	147
1-1546727-6	JC6-E408-16	147
1-1546727-7	JC6-E408-17	147
1-1546727-8	JC6-E408-18	147
1-1546727-9	JC6-E408-19	147
1-1546781-0	BC6-Q308-17	134
1-1546781-1	BC6-Q308-18	134
1-1546781-2	BC6-Q608-15	134
1-1546781-3	BC6-Q608-16	134
1-1546783-2	BC6-Q608-17	134
1-1546783-3	BC6-Q608-18	134

Tyco Part Number	BUCHANAN Part Number	Page Number
1-1546784-0	BC6-W408-17	134
1-1546784-1	BC6-W408-18	134
1-1546784-2	BC6-W408-19	134
1-1546784-3	BC6-W408-20	134
1-1546820-0	6STV-10-008	129
1-1546820-1	6STV-11-008	129
1-1546820-2	6STV-12-008	129
1-1546820-3	6STV-13-008	129
1-1546820-4	6STV-14-008	129
1-1546820-5	6STV-15-008	129
1-1546820-6	6STV-16-008	129
1-1546820-7	6STV-17-008	129
1-1546820-8	6STV-18-008	129
1-1546820-9	6STV-19-008	129
1-1546821-0	6DBL-10-007	129
1-1546821-1	6DBL-11-007	129
1-1546821-2	6DBL-12-007	129
1-1546821-3	6DBL-13-007	129
1-1546821-4	6DBL-14-007	129
1-1546821-5	6DBL-15-007	129
1-1546821-6	6DBL-16-007	129
1-1546821-7	6DBL-17-007	129
1-1546821-8	6DBL-18-007	129
1-1546821-9	6DBL-19-007	129
1-1546840-0	JC6-T208-10	147
1-1546840-1	JC6-T208-11	147
1-1546840-2	JC6-T208-12	147
1-1546840-3	JC6-T208-13	147
1-1546840-4	JC6-T208-14	147
1-1546840-5	JC6-T208-15	147
1-1546840-6	JC6-T208-16	147
1-1546840-7	JC6-T208-17	147
1-1546840-8	JC6-T208-18	147
1-1546840-9	JC6-T208-19	147
1-1546841-0	JC6-Q207-10	147
1-1546841-1	JC6-Q207-11	147
1-1546841-3	JC6-Q207-13	147
1-1546841-4	JC6-Q207-14	147
1-1546841-5	JC6-Q207-15	147
1-1546841-6	JC6-Q207-16	147
1-1546841-7	JC6-Q207-17	147
1-1546841-8	JC6-Q207-18	147
1-1546841-9	JC6-Q207-19	147
1-1546842-0	JC6-Q208-10	147
1-1546842-1	JC6-Q208-11	147
1-1546842-2	JC6-Q208-12	147
1-1546842-3	JC6-Q208-13	147
1-1546842-4	JC6-Q208-14	147
1-1546842-5	JC6-Q208-15	147
1-1546842-6	JC6-Q208-16	147
1-1546842-7	JC6-Q208-17	147
1-1546842-8	JC6-Q208-18	147
1-1546842-9	JC6-Q208-19	147
1-1546885-0	BC6-T308-10	134
1-1546885-1	BC6-T308-11	134
1-1546885-2	BC6-T308-12	134
1-1546885-3	BC6-T308-13	134
1-1546885-4	BC6-T308-14	134
1-1546885-5	BC6-T308-15	134
1-1546885-6	BC6-T308-16	134
1-1546885-7	BC6-T308-17	134
1-1546885-8	BC6-T308-18	134
1-1546885-9	BC6-T308-19	134
1-1546886-0	BC6-P107-10	134
1-1546886-1	BC6-P107-11	134
1-1546886-2	BC6-P107-12	134
1-1546886-3	BC6-P107-13	134
1-1546886-4	BC6-P107-14	134
1-1546886-5	BC6-P107-15	134
1-1546886-6	BC6-P107-16	134
1-1546886-7	BC6-P107-17	134
1-1546886-8	BC6-P107-18	134
1-1546886-9	BC6-P107-19	134
1-1546867-1	BC6-Q408-11	134
1-1546867-2	BC6-Q408-12	134
1-1546867-3	BC6-Q408-13	134
1-1546867-5	BC6-Q408-15	134
1-1546867-6	BC6-Q408-16	134
1-1546867-7	BC6-Q408-17	134
1-1546867-8	BC6-Q408-18	134
1-1546867-9	BC6-Q408-19	134
1-1546928-0	PCB3S10S	186
1-1546928-8	PCB3S18S	186
1-1546937-0	4DBL-15-006	125
1-1546937-1	4DBL-16-006	125
1-1546937-2	4DBL-17-006	125
1-1546937-3	4DBL-18-006	125
1-1546937-4	4DBL-19-006	125
1-1546937-5	4DBL-20-006	125
1-1546937-6	4DBL-21-006	125
1-1546937-7	4DBL-22-006	125
1-1546937-8	4DBL-23-006	125
1-1546937-9	4DBL-24-006	125
1-1546939-0	4PCV-22-008	125
1-1546939-1	4PCV-23-008	125
1-1546939-2	4PCV-24-008	125

Tyco Part Number	BUCHANAN Part Number	Page Number
1-1546939-3	4PCV-25-008	125
1-1546939-4	4PCV-26-008	125
1-1546939-5	4PCV-27-008	125
1-1546939-6	4PCV-28-008	125
1-1546940-0	4PCR-12-008	125
1-1546940-1	4PCR-13-008	125
1-1546940-2	4PCR-14-008	125
1-1546940-3	4PCR-15-008	125
1-1546940-4	4PCR-16-008	125
1-1546940-5	4PCR-17-008	125
1-1546940-6	4PCR-18-008	125
1-1546940-7	4PCR-19-008	125
1-1546940-8	4PCR-20-008	125
1-1546940-9	4PCR-21-008	125
1-1546942-0	BC6-P508-10	134
1-1546942-1	BC6-P508-11	134
1-1546942-2	BC6-P508-12	134
1-1546942-3	BC6-P508-13	134
1-1546942-4	BC6-P508-14	134
1-1546942-5	BC6-P508-15	134
1-1546942-6	BC6-P508-16	134
1-1546942-7	BC6-P508-17	134
1-1546942-8	BC6-P508-18	134
1-1546942-9	BC6-P508-19	134
1-1776008-0	BC6-W308-10	134
1-1776008-1	BC6-W308-11	134
1-1776008-2	BC6-W308-12	134
1-1776008-3	BC6-W308-13	134
1-1776008-4	BC6-W308-14	134
1-1776008-5	BC6-W308-15	134
1-1776008-6	BC6-W308-16	134
1-1776008-7	BC6-W308-17	134
1-1776008-8	BC6-W308-18	134
1-1776008-9	BC6-W308-19	134
1-1776008-10	BC6-W308-20	134
1-1776008-11	BC6-W308-21	134
1-1776008-12	BC6-W308-22	134
1-1776008-13	BC6-W308-23	134
1-1776008-14	BC6-W308-24	134
1-1776008-15	BC6-W308-25	134
1-1776008-16	BC6-W308-26	134
1-1776008-17	BC6-W308-27	134
1-1776008-18	BC6-W308-28	134
1-1776008-19	BC6-W308-29	134
1-1776008-20	BC6-W308-30	134
1-1776008-21	BC6-W308-31	134
1-1776008-22	BC6-W308-32	134
1-1776008-23	BC6-W308-33	134
1-1776008-24	BC6-W308-34	134
1-1776008-25	BC6-W308-35	134
1-1776008-26	BC6-W308-36	134
1-1776008-27	BC6-W308-37	134
1-1776008-28	BC6-W308-38	134
1-1776008-29	BC6-W308-39	134
1-1776008-30	BC6-W308-40	134
1-1776008-31	BC6-W308-41	134
1-1776008-32	BC6-W308-42	134
1-1776008-33	BC6-W308-43	134
1-1776008-34	BC6-W308-44	134
1-1776008-35	BC6-W308-45	134
1-1776008-36	BC6-W308-46	134
1-1776008-37	BC6-W308-47	134
1-1776008-38	BC6-W308-48	134
1-1776008-39	BC6-W308-49	134
1-1776008-40	BC6-W308-50	134
1-1776008-41	BC6-W308-51	134
1-1776008-42	BC6-W308-52	134
1-1776008-43	BC6-W308-53	134
1-1776008-44	BC6-W308-54	134
1-1776008-45	BC6-W308-55	134
1-1776008-46	BC6-W308-56	134
1-1776008-47	BC6-W308-57	134
1-1776008-48	BC6-W308-58	134
1-1776008-49	BC6-W308-59	134
1-1776008-50	BC6-W308-60	134
1-1776008-51	BC6-W308-61	134
1-1776008-52	BC6-W308-62	134
1-1776008-53	BC6-W308-63	134
1-1776008-54	BC6-W308-64	134
1-1776008-55	BC6-W308-65	134
1-1776008-56	BC6-W308-66	134
1-1776008-57	BC6-W308-67	134
1-1776008-58	BC6-W308-68	134
1-1776008-59	BC6-W308-69	134
1-1776008-60	BC6-W308-70	134
1-1776008-61	BC6-W30	

Note: All part numbers are RoHS Compliant.

Tyco Part Number	BUCHANAN Part Number	Page Number
1-1776309-4	1003Si4	229
1-1776309-5	1003Si5	229
1-1776310-0	TSB150010	230
1-1776310-1	TSB150011	230
1-1776310-2	TSB150012	230
1-1776311-0	TSB150010DS	230
1-1776311-1	TSB150011DS	230
1-1776311-2	TSB150012DS	230
1-1776312-0	TSB200010	231
1-1776312-1	TSB200011	231
1-1776312-2	TSB200012	231
1-1776313-0	TSB200010DS	231
1-1776313-1	TSB200011DS	231
1-1776313-2	TSB200012DS	231
1-1776314-0	TSB200010DSHT	232
1-1776314-1	TSB200011DSHT	232
1-1776314-2	TSB200012DSHT	232
1-1776315-0	TSB200010KDS	233
1-1776315-1	TSB200011KDS	233
1-1776315-2	TSB200012KDS	233
1-1776325-0	6STV-10-007	129
1-1776325-1	6STV-11-007	129
1-1776325-2	6STV-12-007	129
1-1776325-3	6STV-13-007	129
1-1776325-4	6STV-14-007	129
1-1776325-5	6STV-15-007	129
1-1776325-6	6STV-16-007	129
1-1776325-7	6STV-17-007	129
1-1776325-8	6STV-18-007	129
1-1776325-9	6STV-19-007	129
1-1776452-0	B71N4V10T	90
1-1776452-1	B71N4V11T	90
1-1776452-2	B71N4V12T	90
1-1776452-3	B71N4V13T	90
1-1776452-4	B71N4V14T	90
1-1776452-5	B71N4V15T	90
1-1776452-6	B71N4V16T	90
1-1776452-7	B71N4V17T	90
1-1776452-8	B71N4V18T	90
1-1776453-0	B71N8V10T	92
1-1776453-1	B71N8V11T	92
1-1776453-2	B71N8V12T	92
1-1776453-3	B71N8V14T	92
1-1776453-4	B71N8V16T	92
1-1776453-7	B71N8V17T	92
1-1776453-8	B71N8V18T	92
1437381-1	10	246
1437381-4	11	154,169,172, 246,247,253,262
1437381-5	115-BU	246
1437381-8	12	154,166,169,172, 173,246,253,262
1437382-1	66	254,275
1437382-2	67	246,253,262,270, 275,279,284,287
1437382-3	68	246,247,253,262, 270,275,279,284
1437382-6	70	253
1437383-2	J102	291
1437383-3	J104	291
1437383-4	J106	291
1437383-5	J108	291
1437383-6	J112	291
1437383-7	LN101-BU	291
1437387-1	1000BZM	237
1437387-2	2000BZM	237
1437387-3	230BZM	237
1437387-6	M1000BZ12	237
1437389-2	D0211	269
1437389-4	D0212	269
1437389-6	D0213	269
1437389-7	D0221	269
1437389-8	D0222	269
1437389-9	D0223	269
1437390-1	211	268
1437390-3	212	268
1437390-5	213	268
1437390-7	218	268
1437390-8	221	268
1437390-9	222	268
1437394-9	0721ERT	252
1437395-2	814	274
1437395-3	824-BU	274,295
1437395-9	HJ112	291
1437396-4	416	278,294
1437396-5	417	278,295
1437396-7	426-BU	278,294
1437396-8	427-BU	278,295
1437396-9	430-BU	278
1437397-1	311	282,294
1437397-2	312	282
1437397-3	318	282
1437397-5	330	282
1437397-6	341	286
1437397-7	342	286

Tyco Part Number	BUCHANAN Part Number	Page Number
1437397-8	348	286
1437397-9	351	286
1437401-1	3C1N07	175
1437402-2	3L01	166,169,178
1437402-3	3L02	166,169,178
1437404-2	3C1F04	175
1437407-3	RSB6B02S	163
1437407-4	RSB6B03S	163
1437407-5	RSB6B04S	163
1437407-6	RSB6B06S	163
1437407-7	RSB6B10S	163
1437408-1	RSB6VP101202	172
1437408-2	RSB6VP1012021	172
1437408-3	RSB6VP10120212AK	172
1437408-5	RSB6VP101203NN60	172
1437408-6	RSB6VP101229	172
1437408-7	RSB6VP111202	172
1437408-8	RSB6VP121202	172
1437408-9	RSB6VP12120221	172
1437409-6	PSB3KCC10	191
1437409-7	PSB3KCC12	191
1437409-8	PSB3KCC14	191
1437409-9	PSB3KCC16	191
1437410-5	PC17	190,191,193,194
1437410-6	PC19	190
1437410-8	PCB1A12A	182
1437410-9	PCB1A12S	182
1437411-2	PCB3A18S	185
1437411-3	PCB3A22A	185
1437411-4	PCB3A22S	185
1437411-5	PCB3A24A	185
1437411-6	PCB3A24S	185
1437411-7	PCB3A30A	185
1437411-8	PCB3A30S	185
1437411-9	PCB3A32A	185
1437412-5	7C1N13	153
1437412-6	7C1N25	153
1437416-1	SSB7FM090201	152
1437416-2	SSB7FP020201	152
1437416-3	SSB7FP02020111	152
1437416-4	SSB7FP020202	152
1437416-5	SSB7FP020203	152
1437416-6	SSB7FP030201	152
1437416-8	SSB7FP030202	152
1437416-9	SSB7FP030203	152
1437417-1	SSB7TG100501	152
1437417-3	SSB7TG190501	152
1437417-4	SSB7TG200401	152
1437417-5	SSB7TM020501	152
1437417-6	SSB7TM040101	152
1437417-7	SSB7TM060101	152
1437417-8	SSB7TM060102	152
1437417-9	SSB7TM08010	152
1437418-3	3C1N02	175
1437418-4	3C1N03	175
1437418-5	3C1N06	175
1437418-6	3C1N12	175
1437426-1	B51C4U02T	89
1437426-3	B51C4U03T	89
1437426-9	B51C4U04T	89
1437429-1	1003SiDS	136,141
1437645-1	TC9-08-AG	174
1437645-2	TC9-09-AG	174
1437645-4	TC9-14-AG	174
1437645-5	TC9-18-AG	174
1437645-6	TR-1	212
1437645-7	TC8-05-AG	174
1437645-8	TC4-05	174
1437656-6	NC6-P104-14	149
1437661-1	11S-SOCKET	210
1437661-7	JC/BC-Retaining	134,147,153,178
1437661-8	TC4-02-PF	174
1437661-9	TC4-02-PFH	174
1437664-3	NC6-P102-04	149
1437664-4	NC6-P107-02	149
1437664-5	NC6-P107-03	149
1437664-6	NC6-P107-04	149
1437664-7	NC6-P107-05	149
1437664-9	NC6-P107-06	149
1437667-6	4DB-P107-02	143
1437667-7	4DB-P107-03	143
1437668-7	4DB-R108-23	143
1437671-1	2SV-02	104
1437671-4	2SV-03	104
1437671-6	2SV-04	104
1437671-7	2SV-05	104
1437671-9	2SV-06	104
1437683-1	11R-SOCKET	210
1437683-3	14S-SOCKET	210
1437683-4	20BS	207
1437683-5	204BS	207
1437683-6	208BR	205
1437683-7	211BR	206
1437683-8	211BS	209
1437683-9	214BS	208

Tyco Part Number	BUCHANAN Part Number	Page Number
1437684-1	22PCB	203,204
1437684-2	2M08DP	202
1437684-3	2M09DSM	200
1437684-4	2M10FC	201
1437684-6	2M14FC	201
1437684-7	2M15DSM	200
1437684-8	2M16DP	202
1437685-1	2TK-48	211
1437685-2	2TK-6	211
1437685-3	2TK2-10	211
1437685-6	2TK2-12	211
1437685-7	2TK2-15	211
1437685-8	2TK2-2	211
1437685-9	2TK2-24	211
1437687-1	FACE-40	192
1437814-1	2TKD-12	211
1437814-2	2TKD-6	211
1447889-1	2400	269
1546143-1	921	250,295
1546143-2	D921	250
1546144-1	921	250
1546144-2	D0921	250
1546147-1	924	250
1546147-2	D924	250
1546148-1	924	250,295
1546148-2	D0924	250
1546149-1	927	250
1546150-1	927	250
1546151-1	929	251
1546152-1	929	251,295
1546163-1	930	250,251
1546164-1	930	250,251
1546182-1	5003ZEL	236
1546182-2	5003ZELRZ	236
1546234-1	925	250
1546234-2	D925	250
1546235-1	925	250,295
1546235-2	D0925	250
1546561-1	SSB7FF020702	152
1546561-2	SSB7FF040702	152
1546561-3	SSB7M050501	152
1546561-4	SSB7FP140203	152
1546561-5	SSB7CE220303	152
1546561-6	SSB7FP03020211	152
1546561-7	SSB7FG041502	152
1546561-8	SSB7TG020501	152
1546561-9	SSB7TG120101	152
1546693-1	2M09DSML	200
1546694-1	2M15DSML	200
1546706-1	071ERT	252
1546830-8	M1000BZ08	237
1546986-1	QC20-BU	176
1546986-3	QC21	176
1546986-4	QC22	176
1776058-1	J76	158,177
1776224-1	2M25DSML	200
1776226-1	SMC2402	101
1776227-1	SM2V02	101
1776293-1	TSB23001DS	218
1776293-2	TSB23002DS	218
1776293-3	TSB23003DS	218
1776293-4	TSB23004DS	218
1776293-5	TSB23005DS	218
1776293-6	TSB23006DS	218
1776293-7	TSB23007DS	218
1776293-8	TSB23008DS	218
1776293-9	TSB23009DS	218
1776294-1	TSB2301	219
1776294-2	TSB23002	216,219
1776294-3	TSB23003	219
1776294-4	TSB23004	219
1776294-6	TSB23006	219
1776294-7	TSB23007	219
1776294-8	TSB23008	219
1776294-9	TSB23009	219
1776295-1	TSB23001DSHT	220
1776295-2	TSB23002DSHT	220
1776295-3	TSB23003DSHT	220
1776295-4	TSB23004DSHT	220
1776295-5	TSB23005DSHT	220
1776295-6	TSB23006DSHT	220
1776295-7	TSB23007DSHT	220
1776295-8	TSB23008DSHT	220
1776295-9	TSB23009DSHT	220
1776296-1	TSB5000131DS	221
1776296-2	TSB5000231DS	221
1776296-3	TSB5000331DS	221
1776296-4	TSB5000431DS	221
1776296-5	TSB5000531DS	221
1776296-6	TSB5000631DS	221
1776296-7	TSB5000731DS	221
1776296-8	TSB5000831DS	221
1776296-9	TSB5000931DS	221
1776297-1	TSB5000131	222
1776297-2	TSB5000231	222

Note: All part numbers are RoHS Compliant.

Tyco Part Number	BUCHANAN Part Number	Page Number
1776297-3	TSB5000331	222
1776297-4	TSB5000431	222
1776297-5	TSB5000531	222
1776297-6	TSB5000631	222
1776297-7	TSB5000731	222
1776297-8	TSB5000831	222
1776297-9	TSB5000931	222
1776298-1	TSB5000131DSHT	223
1776298-2	TSB5000231DSHT	223
1776298-3	TSB5000331DSHT	223
1776298-4	TSB5000431DSHT	223
1776298-5	TSB5000531DSHT	223
1776298-6	TSB5000631DSHT	223
1776298-7	TSB5000731DSHT	223
1776298-8	TSB5000831DSHT	223
1776298-9	TSB5000931DSHT	223
1776299-1	TSB500SK01	224
1776299-2	TSB500SK02	224
1776299-3	TSB500SK03	224
1776299-4	TSB500SK04	224
1776299-5	TSB500SK05	224
1776299-6	TSB500SK06	224
1776299-7	TSB500SK07	224
1776299-8	TSB500SK08	224
1776299-9	TSB500SK09	224
1776300-1	TSB500SK01MDS	224
1776300-2	TSB500SK02MDS	224
1776300-3	TSB500SK03MDS	224
1776300-4	TSB500SK04MDS	224
1776300-5	TSB500SK05MDS	224
1776300-6	TSB500SK06MDS	224
1776300-7	TSB500SK07MDS	224
1776300-8	TSB500SK08MDS	224
1776300-9	TSB500SK09MDS	224
1776301-1	503SI1	225
1776301-2	503SI2	216,225
1776301-3	503SI3	225
1776301-4	503SI4	225
1776301-5	503SI5	225
1776301-6	503SI1DS	225
1776301-7	503SI2DS	225
1776301-8	503SI3DS	225
1776301-9	503SI4DS	225
1776302-1	TSB100001DS	226
1776302-2	TSB100002DS	226
1776302-3	TSB100003DS	226
1776302-4	TSB100004DS	226
1776302-5	TSB100005DS	226
1776302-6	TSB100006DS	226
1776302-7	TSB100007DS	226
1776302-8	TSB100008DS	226
1776302-9	TSB100009DS	226
1776303-1	TSB100001	227
1776303-2	TSB100002	227
1776303-3	TSB100003	227
1776303-4	TSB100004	227
1776303-5	TSB100005	227
1776303-6	TSB100006	227
1776303-7	TSB100007	227
1776303-8	TSB100008	227
1776303-9	TSB100009	227
1776304-1	TSB100001DSHT	228
1776304-2	TSB100002DSHT	228
1776304-3	TSB100003DSHT	228
1776304-4	TSB100004DSHT	228
1776304-5	TSB100005DSHT	228
1776304-6	TSB100006DSHT	228
1776304-7	TSB100007DSHT	228
1776304-8	TSB100008DSHT	228
1776304-9	TSB100009DSHT	228
1776309-1	1003SI1DS	229
1776309-2	1003SI2DS	229
1776309-3	1003SI3E	229
1776309-4	1003SI3EDS	229
1776309-5	1003SI5	229
1776310-1	TSB150001	230
1776310-2	TSB150002	230
1776310-3	TSB150003	230
1776310-4	TSB150004	230
1776310-5	TSB150005	230
1776310-6	TSB150006	230
1776310-7	TSB150007	230
1776310-8	TSB150008	230
1776310-9	TSB150009	230
1776311-1	TSB150001DS	230
1776311-2	TSB150002DS	230
1776311-3	TSB150003DS	230
1776311-4	TSB150004DS	230
1776311-5	TSB150005DS	230
1776311-6	TSB150006DS	230
1776311-7	TSB150007DS	230
1776311-8	TSB150008DS	230
1776311-9	TSB150009DS	230
1776312-1	TSB200001	231
1776312-2	TSB200002	231

Tyco Part Number	BUCHANAN Part Number	Page Number
1776312-3	TSB200003	231
1776312-4	TSB200004	231
1776312-5	TSB200005	231
1776312-6	TSB200006	231
1776312-7	TSB200007	231
1776312-8	TSB200008	231
1776312-9	TSB200009	231
1776313-1	TSB200001DS	231
1776313-2	TSB200002DS	231
1776313-3	TSB200003DS	231
1776313-4	TSB200004DS	231
1776313-5	TSB200005DS	231
1776313-6	TSB200006DS	231
1776313-7	TSB200007DS	231
1776313-8	TSB200008DS	231
1776313-9	TSB200009DS	231
1776314-1	TSB200001DSHT	232
1776314-2	TSB200002DSHT	232
1776314-3	TSB200003DSHT	232
1776314-4	TSB200004DSHT	232
1776314-5	TSB200005DSHT	232
1776314-6	TSB200006DSHT	232
1776314-7	TSB200007DSHT	232
1776314-8	TSB200008DSHT	232
1776314-9	TSB200009DSHT	232
1776315-1	TSB200001KDS	233
1776315-2	TSB200002KDS	233
1776315-3	TSB200003KDS	233
1776315-4	TSB200004KDS	233
1776315-5	TSB200005KDS	233
1776315-6	TSB200006KDS	233
1776315-7	TSB200007KDS	233
1776315-8	TSB200008KDS	233
1776315-9	TSB200009KDS	233
1776452-2	B71N4V02T	90
1776452-3	B71N4V03T	90
1776452-4	B71N4V04T	90
1776452-5	B71N4V05T	90
1776452-6	B71N4V06T	90
1776452-7	B71N4V07T	90
1776452-8	B71N4V08T	90
1776452-9	B71N4V09T	90
1776453-2	B71N8V02T	92
1776453-3	B71N8V03T	92
1776453-4	B71N8V04T	92
1776453-5	B71N8V05T	92
1776453-6	B71N8V06T	92
1776453-7	B71N8V07T	92
1776453-8	B71N8V08T	92
1776453-9	B71N8V09T	92
1776599-1	2M08DPL	202
1776600-1	2M16DPL	202
1776602-1	2M24DPL	202
1776603-1	2M40DPL	202
1776604-1	2M50TELSEL	199
1776612-1	2M37DSML	200
1776613-1	2M50DSML	200
1776614-1	22PCBL	203,204
1776615-1	2M10FCL	201
1776616-1	2M14FCL	201
1776617-1	218BRL	205
1776618-1	314BSL	208
1776619-1	313BRL	205
1776620-1	608BRL	205
1776621-1	608BSL	209
1776622-1	611BRL	206
1776623-1	611BSL	209
1776624-1	2M16DPZL	202
1776625-1	2M16FCL	201
1776626-1	2M20FCL	201
1776627-1	2M22PCBL	203,204
1776628-1	2M24DPZL	202
1776630-1	211BSL	209
1776630-1	2M26FCL	201
1776631-1	202BSL	207
1776632-1	204BSL	207
1776633-1	208BRL	205
1776634-1	211BRL	206
1776636-1	214BSL	208
1776637-1	614BSL	208
1776638-1	2M34FCL	201
1776639-1	2M40DPZL	202
1776640-1	2M40FCL	201
1776641-1	2M44PCL	203,204
1776642-1	2M50FCL	201
1776643-1	2M50TELPCL	199
1776644-1	2M60FCL	201
1776645-1	2M64DINL	196,198
1776646-1	2M64DIN-CL	198
1776647-1	2M64FCL	201
1776649-1	44PCL	203,204
1776721-1	DP241	261
1776722-1	D0241	261
1776723-1	DP242	261
1776724-1	D0242	261
1776724-2	DP0242	261

Tyco Part Number	BUCHANAN Part Number	Page Number
1776726-1	D0318	282
1776727-1	DP0318	282
1776728-1	DP0371	282
1776729-1	D0378	283
1776730-1	DP0378	283
1776731-1	D0372	283
1776732-1	DP0372	283
1776733-2	N102	291
1776774-1	PCB1B30S	183
1776774-7	PCB1B24S	183
1776774-8	PCB1B16S	183
1776826-1	2M36TELSL	199
1776827-1	311BRL	206
1-796602-1	SSB7TM160104	152
1-796602-2	SSB7TM200104	152
1-796602-4	SSB7TG110902	152
1-796602-7	SSB7FE060704	152
1-796602-8	SSB7TG140101	152
1-796602-9	SSB7G250103	152
2-0796598-0	4WWW-19-006	125
2-0796598-1	4WWW-21-006	125
2-0796598-2	4WWW-22-006	125
2-0796598-3	4WWW-23-006	125
2-0796598-4	4WWW-24-006	125
2-0796598-5	4WWW-25-006	125
2-0796598-6	4WWW-26-006	125
2-0796598-7	4WWW-27-006	125
2-0796598-8	4WWW-28-006	125
2-0796598-9	4WWW-02-008	125
2-0796603-0	BC6-Q307-02	134
2-0796603-1	BC6-Q307-07	134
2-0796603-2	BC6-Q307-09	134
2-0796603-3	BC6-Q307-10	134
2-0796603-4	BC6-Q307-11	134
2-0796603-5	BC6-Q307-12	134
2-0796603-6	BC6-Q307-13	134
2-0796603-7	BC6-Q307-14	134
2-0796603-8	BC6-Q307-15	134
2-0796603-9	BC6-Q307-16	134
2-0796607-0	4PCV-07-524	125
2-0796608-0	6WWW-05-008	129
2-0796608-1	6WWW-09-008	129
2-0796608-2	6WWW-13-008	129
2-0796608-3	6WWW-15-008	129
2-0796608-4	6WWW-16-008	129
2-0796608-5	6WWW-18-008	129
2-0796608-6	6WWW-19-008	129
2-0796608-7	6WWW-21-008	129
2-0796608-8	6WWW-22-008	129
2-0796608-9	6WWW-23-008	129
2-0796612-0	6WWW-22-006	129
2-0796612-1	6WWW-23-006	129
2-0796612-2	6WWW-24-006	129
2-0796612-3	6WWW-25-006	129
2-0796612-4	6WWW-26-006	129
2-0796612-5	6WWW-27-006	129
2-0796612-6	6WWW-28-006	129
2-0796612-7	6WWW-02-008	129
2-0796612-8	6WWW-03-008	129
2-0796612-9	6WWW-04-008	129
2-0796985-0	JC6-P208-18	147
2-0796985-1	JC6-Q307-18	147
2-0796985-2	JC6-Q308-03-173	147
2-0796985-3	JC6-Q308-03-174	147
2-0796985-4	JC6-Q308-05-175	147
2-0796985-5	JC6-T408-04	147
2-0796985-6	JC6-T408-05	147
2-0796985-7	JC6-W107-04-176	147
2-0796985-8	JC6-W107-06	147
2-0796985-9	JC6-W108-12	147
2-0796988-3	6PCR-12-1381	129
2-0796988-9	6PCR-12-1382	129
2-1437381-0	2B102	290
2-1437381-1	2B102N	290
2-1437381-2	2B104	290
2-1437381-3	2B104N	290
2-1437381-4	2B104T	290
2-1437381-5	2B106	290
2-1437381-7	2B106H	290
2-1437381-8	2B106N	290
2-1437381-9	2B106T	290
2-1437382-0	7B104	290
2-1437382-1	7B106	290
2-1437382-2	7B108	290
2-1437382-3	7B112	290
2-1437382-4	7B112T	290
2-1437382-5	84	253
2-1437382-6	B102	290,295
2-1437382-7	B102C	290
2-1437382-8	B102S	290,295
2-1437382-9	B102SN	290
2-1437383-3	M500BZ06	237
2-1437387-4	M500BZ12	237
2-1437390-0	242	260

Note: All part numbers are RoHS Compliant.

Tyco Part Number	BUCHANAN Part Number	Page Number
2-1437390-1	243	260
2-1437390-4	248	260
2-1437390-5	250	260
2-1437390-7	211	268,294
2-1437390-8	212	268,294
2-1437390-9	213	268,294
2-1437392-1	120	246
2-1437392-3	125-BU	246,294
2-1437392-5	130-BU	246
2-1437392-9	D105	246
2-1437393-3	41-BU	270
2-1437393-4	42-BU	262
2-1437394-0	0730ERT	252
2-1437397-0	380	282,283
2-1437397-1	31-BU	287
2-1437397-2	32	154,287
2-1437397-4	330-BU	286
2-1437397-5	341	286,294
2-1437397-6	342	286,294
2-1437397-7	348	286,294
2-1437397-8	351	286,294
2-1437401-0	SSB3FP040201	162
2-1437401-1	SSB3FP040202	162
2-1437401-2	SSB3FP041202	162
2-1437401-3	SSB3FP050201	162
2-1437401-4	SSB3FP05020117	162
2-1437401-5	SSB3FP050202	162
2-1437401-6	SSB3FP05020217	162
2-1437401-7	SSB3FP050202NNN60	162
2-1437401-8	SSB3FP060201	162
2-1437401-9	SSB3FP060202	162
2-1437402-4	L01	171,178
2-1437402-5	L02	171,178
2-1437402-6	L03	128,134,147,149,178
2-1437402-7	L04	171,178
2-1437402-8	L09	171,178
2-1437404-0	RSB3VP041201	162
2-1437404-1	RSB3VP041202	162
2-1437404-2	RSB3VP051201	162
2-1437404-3	RSB3VP051202	162
2-1437404-4	RSB3VP05120222	162
2-1437404-5	RSB3VP061201	162
2-1437404-6	RSB3VP061202	164
2-1437404-7	RSB3VP071201	162
2-1437404-8	RSB3VP071202	162
2-1437404-9	RSB3VP081202	162
2-1437406-0	PSB3KC10S	189
2-1437406-2	PSB3KC12A	189
2-1437406-3	PSB3KC12S	189
2-1437406-4	PSB3KC14S	189
2-1437406-5	PSB3KC16A	189
2-1437406-6	PSB3KC16S	189
2-1437406-8	PSB3KC18A	189
2-1437406-9	PSB3KC18S	189
2-1437408-0	RSB6VP161203	172
2-1437408-1	RSB6VP181202	172
2-1437408-3	RSB6VP181203	172
2-1437408-4	RSB6VP191202	172
2-1437408-5	RSB6VP191204	172
2-1437408-6	RSB6VP201202	172
2-1437408-7	RSB6VP211202	172
2-1437408-8	RSB6VP221202	172
2-1437408-9	RSB6VP221203	172
2-1437410-0	PCB1B08S	183
2-1437410-1	PCB1B10A	183
2-1437410-2	PCB1B10AG	183
2-1437410-3	PCB1B10S	183
2-1437410-4	PCB1B10SG	183
2-1437410-5	PCB1B12A	183
2-1437410-6	PCB1B12AG	183
2-1437410-7	PCB1B12S	183
2-1437410-8	PCB1B12SG	183
2-1437410-9	PCB1B15A	183
2-1437411-0	PCB3D36A	187
2-1437411-1	PCB3D36S	187
2-1437411-2	PCB3D44A	187
2-1437411-3	PCB3D44S	187
2-1437411-4	PCB3S10A	186
2-1437411-5	PCB3S15A	186
2-1437411-6	PCB3S15S	186
2-1437411-7	PCB3S22S	186
2-1437411-8	PCB3S22A	186
2-1437411-9	PCB3S22S	186
2-1437416-0	SSB7FP060200	152
2-1437416-1	SSB7FP060201	152
2-1437416-2	SSB7FP060202	152
2-1437416-3	SSB7FP060203	152
2-1437416-4	SSB7FP070201	152
2-1437416-5	SSB7FP07020111	152
2-1437416-6	SSB7FP070203	152
2-1437416-7	SSB7FP080101	152
2-1437416-8	SSB7FP080202	152
2-1437416-9	SSB7FP080203	152
2-1437417-0	SSB7FP150402	152
2-1437417-1	SSB7FP150701	152

Tyco Part Number	BUCHANAN Part Number	Page Number
2-1437417-2	SSB7TP160701	152
2-1437417-3	SSB7TP180102	152
2-1437426-0	B51C4U07T	89
2-1437426-5	B51C4U08T	89
2-1437426-8	B51C4U09T	89
2-1437645-0	TC4-14	174
2-1437645-1	TC9-11-AG	174
2-1437661-0	TC4-07-PFH	174
2-1437661-1	TC4-08-PF	174
2-1437661-2	TC4-08-PFH	174
2-1437661-3	TC4-09-PFH	174
2-1437661-4	TC4-10-PF	174
2-1437661-5	TC4-10-PFH	174
2-1437661-7	TC6-02-PFH	174
2-1437661-8	TC6-03-PF	174
2-1437661-9	TC6-03-PFH	174
2-1437663-8	MB6-P108-04	135
2-1437663-9	MB6-P108-06	135
2-1437664-0	NC6-P107-14	149
2-1437664-1	NC6-P107-15	149
2-1437664-2	NC6-P107-16	149
2-1437664-3	NC6-P107-17	149
2-1437664-5	NC6-P107-20	149
2-1437664-6	NC6-P107-22	149
2-1437664-7	NC6-P107-24	149
2-1437664-8	NC6-P107-25	149
2-1437667-0	4DB-P107-15	143
2-1437667-1	4DB-P107-16	143
2-1437667-2	4DB-P107-25	143
2-1437667-3	4DB-P107-26	143
2-1437667-4	4DB-P108-02	143
2-1437667-5	4DB-P108-03	143
2-1437667-6	4DB-P108-04	143
2-1437667-8	4DB-P108-05	143
2-1437667-9	4DB-P108-06	143
2-1437671-0	2SV-15	104
2-1437671-1	2SV-16	104
2-1437683-0	614BS	208
2-1437683-1	8R-SOCKET	210
2-1437683-2	8S-SOCKET	210
2-1437683-3	RB1-AG	212
2-1437683-5	RB4-AG	212
2-1437683-6	RB5-AG	212
2-1437683-7	SM11	206
2-1437683-8	SM8	205
2-1437684-0	2M34FC	201
2-1437684-1	2M36TELS	199
2-1437684-2	2M37DSF	200
2-1437684-3	2M37DSM	200
2-1437684-4	2M40DP	202
2-1437684-5	2M40DPZ	202
2-1437684-6	2M40FC	201
2-1437684-7	2M44FC	203,204
2-1437684-8	2M50DSF	200
2-1437684-9	2M50DSM	200
2-1437685-0	21K2D-6	211
2-1437685-2	31K2-11	211
2-1437685-3	31K2-12	211
2-1437685-6	31K2-24	211
2-1437685-9	31K2-4	211
2-1546107-0	PCB3A20S	185
2-1546158-2	6DBL-02-1307	129
2-1546159-0	6WWR-14-984	129
2-1546159-1	6WWR-23-1096	129
2-1546174-0	6STR-28-006	129
2-1546174-2	6STR-02-007	129
2-1546174-3	6STR-03-007	129
2-1546174-4	6STR-04-007	129
2-1546174-5	6STR-05-007	129
2-1546174-6	6STR-06-007	129
2-1546174-7	6STR-07-007	129
2-1546174-8	6STR-08-007	129
2-1546174-9	6STR-09-007	129
2-1546399-0	6PCR-15-007	129
2-1546399-1	6PCR-16-007	129
2-1546399-2	6PCR-17-007	129
2-1546399-3	6PCR-18-007	129
2-1546399-4	6PCR-19-007	129
2-1546399-5	6PCR-20-007	129
2-1546399-6	6PCR-21-007	129
2-1546399-7	6PCR-22-007	129
2-1546399-8	6PCR-23-007	129
2-1546399-9	6PCR-24-007	129
2-1546561-0	SSB7TE040101	152
2-1546561-1	SSB7TG040509	152
2-1546561-2	SSB7HP020209	152
2-1546561-3	SSB7HP030209	152
2-1546561-4	SSB7CG030326	152
2-1546561-5	SSB7CG040326	152
2-1546561-6	SSB7CG060326	152
2-1546561-7	SSB7CG0303211	152
2-1546561-8	SSB7CF040321	152
2-1546561-9	SSB7TF03042711	152
2-1546685-0	6DBL-28-006	129
2-1546685-1	6DBL-29-006	129

Tyco Part Number	BUCHANAN Part Number	Page Number
2-1546685-2	6DBL-30-006	129
2-1546686-0	6PCV-27-007	129
2-1546686-1	6PCV-28-007	129
2-1546686-2	6PCV-02-009	129
2-1546686-3	6PCV-02-009	129
2-1546686-4	6PCV-08-009	129
2-1546686-5	6PCV-09-009	129
2-1546686-6	6PCV-10-009	129
2-1546686-7	6PCV-11-009	129
2-1546686-8	6PCV-13-009	129
2-1546686-9	6PCV-14-009	129
2-1546686-9	6PCV-15-009	129
2-1546692-0	6TBV-26-006	129
2-1546692-1	6TBV-27-006	129
2-1546692-2	6TBV-28-006	129
2-1546700-0	JC6-Q308-21	147
2-1546700-1	JC6-Q308-22	147
2-1546700-2	JC6-Q308-23	147
2-1546700-3	JC6-Q407-05	147
2-1546700-4	JC6-Q407-06	147
2-1546700-5	JC6-Q407-07	147
2-1546700-6	JC6-Q407-08	147
2-1546700-7	JC6-Q407-09	147
2-1546700-8	JC6-Q407-10	147
2-1546700-9	JC6-Q407-11	147
2-1546701-0	JC6-T207-16	147
2-1546701-2	JC6-T207-17	147
2-1546701-3	JC6-T207-18	147
2-1546701-4	JC6-T207-19	147
2-1546701-5	JC6-T207-20	147
2-1546701-6	JC6-T207-21	147
2-1546701-7	JC6-T207-22	147
2-1546701-8	JC6-T207-23	147
2-1546701-9	JC6-T308-07	147
2-1546702-0	JC6-W408-24	147
2-1546702-1	JC6-W408-25	147
2-1546702-2	JC6-W407-04	147
2-1546702-3	JC6-W407-05	147
2-1546702-4	JC6-W407-06	147
2-1546702-5	JC6-W407-08	147
2-1546702-6	JC6-W407-09	147
2-1546702-7	JC6-W407-10	147
2-1546702-8	JC6-W407-11	147
2-1546702-9	JC6-W407-13	147
2-1546703-0	JC6-W108-02	147
2-1546703-1	JC6-W108-04	147
2-1546703-2	JC6-W108-06	147
2-1546703-3	JC6-W108-07	147
2-1546703-4	JC6-W108-08	147
2-1546703-5	JC6-W108-09	147
2-1546703-6	JC6-W108-10	147
2-1546703-7	JC6-W108-11	147
2-1546703-8	JC6-W108-13	147
2-1546703-9	JC6-W108-14	147
2-1546718-0	JC6-C707-20	147
2-1546718-1	JC6-C707-21	147
2-1546718-2	JC6-C707-22	147
2-1546718-3	JC6-C707-23	147
2-1546718-4	JC6-C707-02-179	147
2-1546718-5	JC6-C707-02-180	147
2-1546718-6	JC6-C707-04-207	147
2-1546718-7	JC6-C707-02-208	147
2-1546718-8	JC6-C707-03-209	147
2-1546718-9	JC6-C707-03-210	147
2-1546719-0	JC6-C708-20	147
2-1546719-1	JC6-C708-21	147
2-1546719-2	JC6-C708-22	147
2-1546719-3	JC6-C708-23	147
2-1546719-4	JC6-C708-05-217	147
2-1546719-5	JC6-C708-03-218	147
2-1546720-0	JC6-E107-20	147
2-1546720-1	JC6-E107-21	147
2-1546720-2	JC6-E107-22	147
2-1546720-3	JC6-E107-23	147
2-1546720-4	JC6-E107-24	147
2-1546720-5	JC6-E107-25	147
2-1546720-6	JC6-E107-03-181	147
2-1546720-7	JC6-E107-15-182	147
2-1546720-8	JC6-E107-03-221	147
2-1546721-0	JC6-E108-20	147
2-1546721-1	JC6-E108-21	147
2-1546721-2	JC6-E108-22	147
2-1546721-3	JC6-E108-23	147
2-1546721-4	JC6-E108-24	147
2-1546721-5	JC6-E108-25	147
2-1546721-6	JC6-E106-03	147
2-1546722-0	JC6-E207-20	147
2-1546722-1	JC6-E207-21	147
2-1546722-2	JC6-E207-22	147
2-1546722-3	JC6-E208-23	147
2-1546722-4	JC6-E208-20	147
2-1546723-1	JC6-E208-21	147

Note: All part numbers are RoHS Compliant.

Tyco Part Number	BUCHANAN Part Number	Page Number
2-1546724-0	JC6-E307-20	147
2-1546724-1	JC6-E307-21	147
2-1546724-2	JC6-E307-22	147
2-1546724-3	JC6-E307-23	147
2-1546725-0	JC6-E308-20	147
2-1546725-1	JC6-E308-21	147
2-1546725-2	JC6-E308-22	147
2-1546725-3	JC6-E308-23	147
2-1546726-0	JC6-E407-20	147
2-1546726-1	JC6-E407-21	147
2-1546726-2	JC6-E407-22	147
2-1546726-3	JC6-E407-23	147
2-1546726-4	JC6-E407-24	147
2-1546726-5	JC6-E407-25	147
2-1546727-0	JC6-E408-20	147
2-1546727-1	JC6-E408-21	147
2-1546727-2	JC6-E408-22	147
2-1546727-3	JC6-E408-23	147
2-1546727-4	JC6-E408-24	147
2-1546727-5	JC6-E408-25	147
2-1546820-1	6STV-21-008	129
2-1546820-2	6STV-22-008	129
2-1546820-3	6STV-23-008	129
2-1546820-4	6STV-24-008	129
2-1546820-5	6STV-25-008	129
2-1546820-6	6STV-26-008	129
2-1546820-7	6STV-27-008	129
2-1546820-8	6STV-28-008	129
2-1546820-9	6STV-29-008	129
2-1546821-0	6DBL-20-007	129
2-1546821-1	6DBL-21-007	129
2-1546821-2	6DBL-22-007	129
2-1546821-3	6DBL-23-007	129
2-1546821-4	6DBL-24-007	129
2-1546821-5	6DBL-25-007	129
2-1546821-6	6DBL-26-007	129
2-1546821-7	6DBL-27-007	129
2-1546821-8	6DBL-28-007	129
2-1546821-9	6DBL-29-007	129
2-1546840-0	JC6-T208-20	147
2-1546840-1	JC6-T208-21	147
2-1546840-2	JC6-T208-22	147
2-1546840-3	JC6-T208-23	147
2-1546841-0	JC6-Q207-20	147
2-1546841-1	JC6-Q207-21	147
2-1546841-2	JC6-Q207-22	147
2-1546841-3	JC6-Q207-23	147
2-1546842-0	JC6-Q208-20	147
2-1546842-1	JC6-Q208-21	147
2-1546842-2	JC6-Q208-22	147
2-1546842-3	JC6-Q208-23	147
2-1546842-4	JC6-Q208-24	147
2-1546866-0	BC6-P107-20	134
2-1546866-1	BC6-P107-03-287	134
2-1546866-2	BC6-P107-03-288	134
2-1546867-0	BC6-Q408-20	134
2-1546937-0	4DBL-25-006	125
2-1546937-1	4DBL-26-006	125
2-1546937-2	4DBL-27-006	125
2-1546937-3	4DBL-28-006	125
2-1546937-4	4DBL-29-006	125
2-1546937-5	4DBL-30-006	125
2-1546940-0	4PCR-22-008	125
2-1546940-1	4PCR-23-008	125
2-1546940-2	4PCR-24-008	125
2-1546940-3	4PCR-25-008	125
2-1546940-4	4PCR-26-008	125
2-1546940-5	4PCR-27-008	125
2-1546940-6	4PCR-28-008	125
2-1546942-0	BC6-P508-20	134
2-1776008-0	BC6-W308-03-286	134
2-1776037-0	6STR-20-009	129
2-1776037-1	6STR-21-009	129
2-1776037-2	6STR-22-009	129
2-1776037-3	6STR-23-009	129
2-1776037-4	6STR-24-009	129
2-1776037-5	6STR-25-009	129
2-1776037-6	6STR-26-009	129
2-1776037-7	6STR-27-009	129
2-1776037-8	6STR-28-009	129
2-1776100-0	BC6-W108-20	134
2-1776301-3	503Si3EDS	225
2-1776325-0	6STV-20-007	129
2-1776325-1	6STV-21-007	129
2-1776325-2	6STV-22-007	129
2-1776325-3	6STV-23-007	129
2-1776325-4	6STV-24-007	129
2-1776325-5	6STV-25-007	129
2-1776325-6	6STV-26-007	129
2-1776325-7	6STV-27-007	129
2-1776325-8	6STV-28-007	129
2-1776325-9	6STV-21-404	129
2-1776452-0	B71N4V20T	90
2-1776452-2	B71N4V22T	90
2-1776452-4	B71N4V24T	90

Tyco Part Number	BUCHANAN Part Number	Page Number
2-1776453-0	B71N8V20T	92
2-1776453-2	B71N8V22T	92
2-1776453-4	B71N8V24T	92
2-796602-0	SSB7TG130902	152
2-796602-9	SSB7FF250104	152
3-0796598-0	4WVVV-07-008	125
3-0796598-1	4WVVV-09-008	125
3-0796598-2	4WVVV-11-008	125
3-0796598-3	4WVVV-12-008	125
3-0796598-4	4WVVV-13-008	125
3-0796598-5	4WVVV-15-008	125
3-0796598-6	4WVVV-17-008	125
3-0796598-7	4WVVV-18-008	125
3-0796598-8	4WVVV-19-008	125
3-0796598-9	4WVVV-20-008	125
3-0796603-0	BC6-Q307-17	134
3-0796603-1	BC6-Q307-18	134
3-0796608-0	6WVVV-25-008	129
3-0796608-1	6WVVV-26-008	129
3-0796608-2	6WVVV-27-008	129
3-0796608-3	6WVVV-28-008	129
3-0796608-4	6WVVV-29-008	129
3-0796608-5	6WVVV-30-008	129
3-0796612-0	6WVVV-07-008	129
3-0796612-1	6WVVV-08-008	129
3-0796612-2	6WVVV-10-008	129
3-0796612-3	6WVVV-11-008	129
3-0796612-4	6WVVV-12-008	129
3-0796612-5	6WVVV-13-008	129
3-0796612-6	6WVVV-15-008	129
3-0796612-7	6WVVV-16-008	129
3-0796612-8	6WVVV-17-008	129
3-0796612-9	6WVVV-18-008	129
3-0796985-0	JC6-W108-20	147
3-0796985-1	JC6-W205-08	147
3-0796985-2	JC6-W208-07	147
3-0796985-3	JC6-W308-03-177	147
3-0796985-4	JC6-T207-05-148	147
3-0796985-5	JC6-W405-16-164	147
3-0796985-6	JC6-W406-04	147
3-0796985-7	JC6-W406-05	147
3-0796985-8	JC6-P105-12	147
3-0796985-9	JC6-P105-12-165	147
3-0796988-6	4WVVV-10-004	125
3-1437381-0	2B108	290
3-1437381-1	2B108N	290
3-1437381-2	2B108TN	290
3-1437381-3	2B112	290
3-1437381-4	2B112HN	290
3-1437381-5	2B112N	290
3-1437381-6	2B112T	290
3-1437381-7	2B112TN	290
3-1437381-9	30-BU	253,262,270,275
3-1437382-0	B104	290
3-1437382-1	B104C	290
3-1437382-2	B104CH	290
3-1437382-3	B104CHN	290
3-1437382-4	B104H	290
3-1437382-5	B104N	290
3-1437382-6	B104S	290
3-1437382-7	B104SH	290
3-1437382-8	B104SN	290
3-1437389-2	D115	246
3-1437389-3	D125	246
3-1437389-4	D211	269
3-1437389-5	D212	269
3-1437389-6	D221	269
3-1437389-8	D222	269
3-1437389-9	D223	269
3-1437390-0	218	268,294
3-1437390-1	221	268
3-1437390-3	222-BU	268,294
3-1437390-6	223-BU	268
3-1437390-9	241	260,294
3-1437392-1	J10	246
3-1437392-2	J2-BU	246
3-1437394-6	BP035M	251
3-1437394-7	BP35F	251
3-1437397-0	352	286,294
3-1437397-1	358	286,294
3-1437397-2	361	294
3-1437397-3	362-BU	286,294
3-1437397-5	368-BU	286
3-1437401-0	SSB3FP060402	162
3-1437401-1	SSB3FP060702	162
3-1437401-2	SSB3FP070202	162
3-1437401-3	SSB3FP080201	162
3-1437401-4	SSB3FP080202	162
3-1437401-5	SSB3FP08020211	162
3-1437401-6	SSB3FP080202NN60	162
3-1437401-7	SSB3FP080702	162
3-1437401-8	SSB3FP090201	162
3-1437401-9	SSB3FP090202	162
3-1437404-0	RSB3VP091202	162
3-1437404-2	RSB3VP101201	162

Tyco Part Number	BUCHANAN Part Number	Page Number
3-1437404-3	RSB3VP101202	162
3-1437404-4	RSB3VP10120221	162
3-1437404-6	RSB3VP111202	162
3-1437404-7	RSB3VP121201	162
3-1437404-8	RSB3VP121202	162
3-1437406-0	PSB3KC20S	189
3-1437406-1	PSB3KC22S	189
3-1437406-2	PSB3KC24S	189
3-1437406-3	PSB3KC28SNN24	189
3-1437406-4	PSB3KCC08	189
3-1437406-6	PSB3KCC22	191
3-1437408-0	RSB6VP221203NN60	172
3-1437408-1	RSB6VP231202	172
3-1437408-2	RSB6VP241202	172
3-1437408-3	RSB6VP241203	172
3-1437408-4	RSB6VP271201	172
3-1437408-5	RSB6VP271202	172
3-1437408-6	RSB6VP281202	172
3-1437408-7	RSB6VP291202	172
3-1437409-5	PSB3KCC22	191
3-1437410-0	PCB1B1SAG	183
3-1437410-1	PCB1B1SS	183
3-1437410-2	PCB1B1BAG	183
3-1437410-3	PCB1B1BSG	183
3-1437410-4	PCB1B1BA	183
3-1437410-5	PCB1B1BAG	183
3-1437410-6	PCB1B1BS	183
3-1437410-7	PCB1B1BSG	183
3-1437410-8	PCB1B22A	183
3-1437410-9	PCB1B22AG	183
3-1437411-0	PCB5B36A	188
3-1437416-0	SSB7FP080204	152
3-1437416-1	SSB7FP080401	152
3-1437416-2	SSB7FP090202	152
3-1437416-3	SSB7FP090401	152
3-1437416-4	SSB7FP100201	152
3-1437416-5	SSB7FP100203	152
3-1437416-6	SSB7FP100203	152
3-1437416-7	SSB7FP100280	152
3-1437416-8	SSB7FP110200	152
3-1437416-9	SSB7FP110203	152
3-1437418-7	7CT1F3	153
3-1437418-8	7CT1F6	153
3-1437418-9	7CT1N2	153
3-1437426-2	B51C4U10T	89
3-1437426-6	B51C4U11T	89
3-1437426-9	B51C4U12T	89
3-1437644-4	J3-2	177
3-1437644-5	J3-22	177
3-1437644-6	J3-8	177
3-1437644-7	J4-2	177
3-1437644-8	J4-3	177
3-1437644-9	J4-4	177
3-1437661-1	TC6-04-PFH	174
3-1437661-2	TC6-04-PFH	174
3-1437661-3	TC6-05-PFH	174
3-1437661-4	TC6-05-PFH	174
3-1437661-5	TC6-06-PFH	174
3-1437661-7	TC6-06-PFH	174
3-1437661-8	TC6-07-PFH	174
3-1437661-9	TC6-08-PFH	174
3-1437663-0	MB6-P108-08	135
3-1437663-1	MB6-P108-10	135
3-1437663-2	MB6-P108-12	135
3-1437663-3	MB6-P108-14	135
3-1437663-4	MB6-P108-16	135
3-1437663-5	MB6-P108-18	135
3-1437663-6	MB6-P108-20	135
3-1437664-0	NC6-P108-02	149
3-1437664-1	NC6-P108-03	149
3-1437664-3	NC6-P108-04	149
3-1437664-5	NC6-P108-05	149
3-1437664-8	NC6-P108-06	149
3-1437664-9	NC6-P108-06-049	149
3-1437667-0	4DB-P108-07	143
3-1437667-1	4DB-P108-08	143
3-1437667-2	4DB-P108-09	143
3-1437667-3	4DB-P108-10	143
3-1437667-5	4DB-P108-11	143
3-1437667-6	4DB-P108-12	143
3-1437667-7	4DB-P108-13	143
3-1437667-8	4DB-P108-14	143
3-1437667-9	4DB-P108-15	143
3-1437683-0	TB1	205,206,212
3-1437684-0	2M50FC	201
3-1437684-1	2M50TFLP	199
3-1437684-2	2M50TELS	199
3-1437684-3	2M60FC	201
3-1437684-4	2M64DIN	198
3-1437684-5	2M64DIN-C	198
3-1437684-6	2M64FC	201
3-1437684-7	44PC	203,20

Note: All part numbers are RoHS Compliant.

Tyco Part Number	BUCHANAN Part Number	Page Number
3-1437685-5	3TK2D-12	211
3-1437685-6	3TK2D-24	211
3-1437685-7	3TK2D-48	211
3-1437685-8	3TK2D-6	211
3-1546107-4	PCB3A34S	185
3-1546158-2	6PCR-06-008	129
3-1546159-2	6WVV-12-006	129
3-1546159-7	6WVV-20-1019	129
3-1546174-0	6STR-11-007	129
3-1546174-1	6STR-12-007	129
3-1546174-2	6STR-13-007	129
3-1546174-3	6STR-14-007	129
3-1546174-4	6STR-15-007	129
3-1546174-5	6STR-16-007	129
3-1546174-6	6STR-17-007	129
3-1546174-7	6STR-18-007	129
3-1546174-8	6STR-19-007	129
3-1546174-9	6STR-20-007	129
3-1546399-0	6PCR-25-007	129
3-1546399-1	6PCR-26-007	129
3-1546399-2	6PCR-27-007	129
3-1546399-3	6PCR-07-008	129
3-1546399-4	6PCR-09-008	129
3-1546399-5	6PCR-11-008	129
3-1546399-6	6PCR-12-008	129
3-1546399-7	6PCR-13-008	129
3-1546399-8	6PCR-14-008	129
3-1546399-9	6PCR-15-008	129
3-1546561-0	SSB7TP100508	152
3-1546561-1	SSB7CG020321	152
3-1546561-2	SSB7TF02042711	152
3-1546561-3	SSB7CF25030229	152
3-1546561-4	SSB7RP070202	152
3-1546561-5	SSB7TG180503	152
3-1546686-0	6PCV-16-009	129
3-1546686-1	6PCV-17-009	129
3-1546686-2	6PCV-18-009	129
3-1546686-3	6PCV-19-009	129
3-1546686-4	6PCV-20-009	129
3-1546686-5	6PCV-21-009	129
3-1546686-6	6PCV-22-009	129
3-1546686-7	6PCV-23-009	129
3-1546686-8	6PCV-24-009	129
3-1546686-9	6PCV-25-009	129
3-1546700-0	JC6-Q407-12	147
3-1546700-1	JC6-Q407-13	147
3-1546700-2	JC6-Q407-14	147
3-1546700-3	JC6-Q407-15	147
3-1546700-4	JC6-Q407-16	147
3-1546700-5	JC6-Q407-17	147
3-1546700-6	JC6-Q407-18	147
3-1546700-7	JC6-Q407-19	147
3-1546700-8	JC6-Q407-20	147
3-1546700-9	JC6-Q407-21	147
3-1546701-0	JC6-T308-11	147
3-1546701-1	JC6-T308-12	147
3-1546701-2	JC6-T308-13	147
3-1546701-3	JC6-T308-14	147
3-1546701-4	JC6-T308-15	147
3-1546701-5	JC6-T308-16	147
3-1546701-6	JC6-T308-17	147
3-1546701-7	JC6-T308-18	147
3-1546701-8	JC6-T308-19	147
3-1546701-9	JC6-T308-20	147
3-1546702-0	JC6-W407-14	147
3-1546702-1	JC6-W407-15	147
3-1546702-2	JC6-W407-16	147
3-1546702-3	JC6-W407-17	147
3-1546702-4	JC6-W407-18	147
3-1546702-5	JC6-W407-19	147
3-1546702-6	JC6-W407-20	147
3-1546702-7	JC6-W407-21	147
3-1546702-8	JC6-W407-22	147
3-1546702-9	JC6-W407-23	147
3-1546703-0	JC6-W108-15	147
3-1546703-1	JC6-W108-16	147
3-1546703-2	JC6-W108-17	147
3-1546703-3	JC6-W108-18	147
3-1546703-4	JC6-W108-19	147
3-1546703-5	JC6-W108-21	147
3-1546703-6	JC6-W108-22	147
3-1546703-7	JC6-W108-23	147
3-1546703-8	JC6-W108-24	147
3-1546703-9	JC6-W108-25	147
3-1546718-0	JC6-C707-03-211	147
3-1546718-1	JC6-C707-05-212	147
3-1546718-2	JC6-C707-10-213	147
3-1546718-3	JC6-C707-11-214	147
3-1546718-4	JC6-C707-20-215	147
3-1546718-5	JC6-C707-05-216	147
3-1546820-0	6STV-30-008	129
3-1546821-0	6DBL-30-007	129
4-0796598-0	4WVV-21-008	125
4-0796598-1	4WVV-22-008	125
4-0796598-2	4WVV-23-008	125

Tyco Part Number	BUCHANAN Part Number	Page Number
4-0796598-3	4WVV-25-008	125
4-0796598-4	4WVV-26-008	125
4-0796598-5	4WVV-27-008	125
4-0796598-6	4WVV-28-008	125
4-0796598-7	4WVV-29-008	125
4-0796598-8	4WVV-30-008	125
4-0796612-0	6WVV-19-008	129
4-0796612-1	6WVV-20-008	129
4-0796612-2	6WVV-21-008	129
4-0796612-3	6WVV-22-008	129
4-0796612-4	6WVV-23-008	129
4-0796612-5	6WVV-24-008	129
4-0796612-6	6WVV-25-008	129
4-0796612-7	6WVV-26-008	129
4-0796612-8	6WVV-27-008	129
4-0796612-9	6WVV-28-008	129
4-0796985-0	JC6-Q305-12	147
4-0796985-1	JC6-T305-12-204	147
4-0796985-2	JC6-P108-07	147
4-0796985-3	JC6-P108-13	147
4-0796985-4	JC6-P108-15	147
4-0796985-5	JC6-P108-18	147
4-0796985-6	JC6-P108-19	147
4-0796985-7	JC6-P108-20	147
4-0796985-8	JC6-P108-22	147
4-0796985-9	JC6-P108-23	147
4-1437381-0	3B102P	290
4-1437381-1	3B104P	290
4-1437381-3	3B106P	290
4-1437381-5	3B108P	290
4-1437381-7	3B112P	290
4-1437382-0	B106-BU	290
4-1437382-1	B106C	290
4-1437382-2	B106C-N	290
4-1437382-3	B106H	290
4-1437382-4	B106N	290
4-1437382-5	B106S	290
4-1437382-6	B106SN	290
4-1437382-8	B106T	290
4-1437382-9	B108	290
4-1437389-0	D241	261
4-1437389-1	D242	261
4-1437389-2	D243	261
4-1437389-6	D213	269
4-1437390-0	242	260,294
4-1437390-1	243	260,294
4-1437390-2	248	260,294
4-1437390-3	250	260,294
4-1437390-4	93-BU	275
4-1437391-1	52	154,275
4-1437392-7	P125	246
4-1437392-9	P130	246
4-1437393-0	65-BU	254,262,270
4-1437393-1	74100	254
4-1437397-0	P0311	282
4-1437397-2	P0312	282
4-1437397-3	P0318	282
4-1437397-4	P0371	282
4-1437397-5	P0372	283
4-1437397-6	P0378	283
4-1437397-7	P0380	282,283
4-1437401-0	SSB3FP100201	162
4-1437401-1	SSB3FP100202	162
4-1437401-2	SSB3FP100402	162
4-1437401-3	SSB3FP110202NN60	162
4-1437401-4	SSB3FP110702	162
4-1437401-5	SSB3FP120201	162
4-1437401-6	SSB3FP120202	162
4-1437401-7	SSB3FP130201	162
4-1437401-8	SSB3FP130202	162
4-1437401-9	SSB3VP142001	162
4-1437404-0	RSB3VP131202	162
4-1437404-1	RSB3VP141201	162
4-1437404-2	RSB3VP141202	162
4-1437404-3	RSB3VP151202	162
4-1437404-4	RSB3VP161202	162
4-1437404-5	RSB3VP161202NN60	162
4-1437404-6	RSB3VP171202	162
4-1437404-8	RSB3VP181202	162
4-1437404-9	RSB3VP201202	162
4-1437410-0	PCB1B22S	183
4-1437410-1	PCB1B22SG	183
4-1437410-2	PCB1B28A	183
4-1437410-3	PCB1B28AG	183
4-1437410-4	PCB1B28S	183
4-1437410-5	PCB1B28SG	183
4-1437410-6	PCB1B30SG	183
4-1437410-7	PCB1B32A	183
4-1437410-8	PCB1B32AG	183
4-1437410-9	PCB1B32S	183
4-1437416-0	SSB7FP120201	152
4-1437416-1	SSB7FP120202	152
4-1437416-2	SSB7FP120203	152
4-1437416-3	SSB7FP130201	152
4-1437416-4	SSB7FP140102	152

Tyco Part Number	BUCHANAN Part Number	Page Number
4-1437416-5	SSB7FP140201	152
4-1437416-6	SSB7FP150201	152
4-1437416-7	SSB7FP150202	152
4-1437416-8	SSB7FP150203	152
4-1437416-9	SSB7FP150902	152
4-1437418-0	7C1N03	153
4-1437418-1	7C1N04	153
4-1437418-2	7C1N05	153
4-1437418-3	7C1N06	153
4-1437418-4	7C1N07	153
4-1437418-5	7C1N08	153
4-1437418-6	7C1N09	153
4-1437418-7	7C1N10	153
4-1437418-8	7C1N12	153
4-1437418-9	7C1N16	153
4-1437426-6	B51CAU13T	89
4-1437426-9	B51CAU14T	89
4-1437644-0	J4-5	177
4-1437644-1	J4-9	177
4-1437644-3	J6-10	177
4-1437644-4	J6-11	177
4-1437644-5	J6-13	177
4-1437644-6	J6-16	177
4-1437644-8	J6-20	177
4-1437644-9	J6-3	177
4-1437661-0	TC6-08-PFH	174
4-1437661-2	TC6-09-PFH	174
4-1437661-3	TC6-10-PF	174
4-1437661-4	TC6-10-PFH	174
4-1437661-5	TC6-12-PFH	174
4-1437661-6	TC6-15-PFH	174
4-1437661-7	TC6-16-PFH	174
4-1437661-8	TC8-02-PF	174
4-1437661-9	TC8-03-PF	174
4-1437664-0	NC6-P108-07	149
4-1437664-1	NC6-P108-08	149
4-1437664-2	NC6-P108-09	149
4-1437664-3	NC6-P108-10	149
4-1437664-4	NC6-P108-11	149
4-1437664-5	NC6-P108-12	149
4-1437664-6	NC6-P108-13	149
4-1437664-7	NC6-P108-14	149
4-1437664-8	NC6-P108-15	149
4-1437664-9	NC6-P108-16	149
4-1437667-0	4DB-P108-16	143
4-1437667-2	4DB-P108-17	143
4-1437667-4	4DB-P108-18	143
4-1437667-5	4DB-P108-19	143
4-1437667-6	4DB-P108-20	143
4-1437667-8	4DB-P108-22	143
4-1437685-6	6TK2-12	211
4-1437685-7	6TK2-14	211
4-1437685-8	6TK2-2	211
4-1437685-9	6TK2-4	211
4-1546158-1	6PCR-19-1139	129
4-1546158-3	6PCV-02-1210	129
4-1546158-4	6PCV-02-1216	129
4-1546158-7	6PCV-03-1256	129
4-1546158-8	6PCV-03-923	129
4-1546159-0	6DBL-07-1372	129
4-1546174-0	6STR-21-007	129
4-1546174-1	6STR-22-007	129
4-1546174-2	6STR-23-007	129
4-1546174-3	6STR-24-007	129
4-1546174-4	6STR-25-007	129
4-1546174-5	6STR-26-007	129
4-1546174-6	6STR-27-007	129
4-1546174-7	6STR-28-007	129
4-1546399-0	6PCR-16-008	129
4-1546399-1	6PCR-17-008	129
4-1546399-2	6PCR-18-008	129
4-1546399-3	6PCR-19-008	129
4-1546399-4	6PCR-20-008	129
4-1546399-5	6PCR-21-008	129
4-1546399-6	6PCR-22-008	129
4-1546399-7	6PCR-23-008	129
4-1546399-8	6PCR-24-008	129
4-1546399-9	6PCR-25-008	129
4-1546686-0	6PCV-26-009	129
4-1546686-1	6PCV-27-009	129
4-1546686-2	6PCV-28-009	129
4-1546686-3	6PCV-23-006	129
4-1546686-4	6PCV-30-006	129
4-1546686-5	6PCV-03-1384	129
4-1546686-7	6PCV-03-1385	129
4-1546686-8	6PCV-16-1388	129
4-1546686-9	6PCV-16-1389	129
4-1546700-0	JC6-Q407-22	147
4-1546700-1	JC6-Q407-23	147
4-1546700-2	JC6-Q407-24	147
4-1546700-3	JC6-Q408-04	147
4-1546700-4	JC6-Q408-07	147
4-1546700-6	JC6-Q4	

Note: All part numbers are RoHS Compliant.

Tyco Part Number	BUCHANAN Part Number	Page Number
4-1546700-9	JC6-Q408-11	147
4-1546701-0	JC6-T308-21	147
4-1546701-1	JC6-T308-22	147
4-1546701-2	JC6-T308-23	147
4-1546701-3	JC6-T407-02	147
4-1546701-4	JC6-T407-06	147
4-1546701-5	JC6-T407-07	147
4-1546701-6	JC6-T407-08	147
4-1546701-7	JC6-T407-10	147
4-1546701-8	JC6-T407-11	147
4-1546701-9	JC6-T407-12	147
4-1546702-0	JC6-W407-24	147
4-1546702-1	JC6-W407-25	147
4-1546702-2	JC6-W308-03	147
4-1546702-3	JC6-W308-04	147
4-1546702-4	JC6-W308-06	147
4-1546702-5	JC6-W308-07	147
4-1546702-6	JC6-W308-09	147
4-1546702-7	JC6-W308-10	147
4-1546702-8	JC6-W308-11	147
4-1546702-9	JC6-W308-13	147
4-1546703-0	JC6-W107-02	147
4-1546703-1	JC6-W107-04	147
4-1546703-2	JC6-W107-07	147
4-1546703-3	JC6-W107-08	147
4-1546703-4	JC6-W107-09	147
4-1546703-5	JC6-W107-11	147
4-1546703-6	JC6-W107-12	147
4-1546703-7	JC6-W107-13	147
4-1546703-8	JC6-W107-14	147
4-1546703-9	JC6-W107-15	147
5-0796985-0	JC6-P108-24	147
5-0796985-1	JC6-P108-25	147
5-0796985-2	JC6-P208-07	147
5-0796985-3	JC6-P208-08	147
5-0796985-4	JC6-P208-10	147
5-0796985-5	JC6-P208-11	147
5-0796985-6	JC6-P208-12	147
5-0796985-7	JC6-P208-13	147
5-0796985-8	JC6-P208-14	147
5-0796985-9	JC6-P208-16	147
5-1437381-5	43	154
5-1437381-6	4B102P	290
5-1437381-7	4B104P	290
5-1437381-8	4B106P	290
5-1437381-9	4B108P	290
5-1437382-0	B108C	290
5-1437382-1	B108CN	290
5-1437382-2	B108H	290
5-1437382-3	B108HN	290
5-1437382-4	B108N	290
5-1437382-5	B108S	290
5-1437382-6	B108SN	290
5-1437382-8	B108T	290
5-1437382-9	B112-BU	290,295
5-1437389-8	D814-BU	274
5-1437389-9	D824	274
5-1437390-9	P0241	260
5-1437401-0	SSB3FP140202	162
5-1437401-1	SSB3FP150202	162
5-1437401-2	SSB3FP150401	162
5-1437401-3	SSB3FP160202	162
5-1437401-4	SSB3FP170202	162
5-1437401-5	SSB3FP180202	162
5-1437401-6	SSB3FP180402	162
5-1437401-7	SSB3FP190202	162
5-1437401-8	SSB3FP200202	162
5-1437401-9	SSB3FP210202	162
51437402-1	L91	153,178
5-1437402-2	L92	153
5-1437402-7	QC10	176
5-1437402-8	CC11	176
5-1437402-9	QC12	176
5-1437404-0	RSB3VP211202	162
5-1437404-1	RSB3VP241202	162
5-1437404-3	USB3B02S	162
5-1437404-4	USB3B03S	162
5-1437404-5	USB3B04S	162
5-1437404-6	USB3B05S	162
5-1437404-7	USB3B06S	162
5-1437404-8	USB3B07S	162
5-1437404-9	USB3B08S	162
5-1437406-3	PSB4KC06A	191
5-1437406-4	PSB4KC06S	191
5-1437406-5	PSB4KC08A	191
5-1437406-6	PSB4KC08ANN25	191
5-1437406-7	PSB4KC08S	191
5-1437406-8	PSB4KC10S	191
5-1437406-9	PSB4KC10SNN25	191
5-1437407-8	RSB6VP021202	172
5-1437410-0	PCB1B32SG	183
5-1437410-1	PCB1B36A	183
5-1437410-2	PCB1B36AG	183
5-1437410-3	PCB1B36S	183
5-1437410-4	PCB1B36SG	183

Tyco Part Number	BUCHANAN Part Number	Page Number
5-1437410-5	PCB1B43A	183
5-1437410-6	PCB1B43AG	183
5-1437410-7	PCB1B43S	183
5-1437410-8	PCB1B43SG	183
5-1437410-9	PCB2B06A	184
5-1437416-0	SSB7FP170202	152
5-1437416-1	SSB7FP18020212	152
5-1437416-2	SSB7FP200202	152
5-1437416-3	SSB7FP250202	152
5-1437416-4	SSB7FP260202	152
5-1437416-5	SSB7HF030202	152
5-1437416-6	SSB7HF060202	152
5-1437416-7	SSB7HG080404	152
5-1437416-8	SSB7HM130202	152
5-1437416-9	SSB7HP020202	152
5-1437417-6	SSB7TG010501	152
5-1437417-7	SSB7TP120502	152
5-1437418-0	7C1N19	153
5-1437418-1	7C1N48	153
5-1437418-3	J3140	166,169,177
5-1437418-4	J6140	156,177,194
5-1437418-5	J6240	156,177,194
5-1437418-6	J6340	156,177,194
5-1437418-7	J7140	158,177
5-1437418-8	J7240	158,177
5-1437418-9	J7340	158,177
5-1437426-1	B51C4U15T	89
5-1437426-3	B51C4U16T	89
5-1437426-6	B51C4U18T	89
5-1437426-7	B51C4U20T	89
5-1437426-8	B51C4U22T	89
5-1437426-9	B51C4U24T	89
5-1437644-0	J6-4	177
5-1437644-1	J6-6	177
5-1437644-2	J6-7	177
5-1437644-3	J6-8	177
5-1437644-4	J8-2	177
5-1437644-5	J8-3	177
5-1437644-6	J8-4	177
5-1437644-7	QC41803	176
5-1437644-8	QC6-180-3	191
5-1437644-9	QC6-180-4	191
5-1437652-4	6PCV-03-006	129
5-1437661-0	TC8-03-PFH	174
5-1437661-1	TC8-04-PF	174
5-1437661-2	TC8-04-PFH	174
5-1437661-3	TC8-05-PF	174
5-1437661-4	TC8-05-PFH	174
5-1437661-5	TC8-06-PF	174
5-1437661-6	TC8-06-PFH	174
5-1437661-7	TC8-07-PF	174
5-1437661-8	TC8-07-PFH	174
5-1437661-9	TC8-08-PF	174
5-1437684-0	NC6-P108-15	149
5-1437684-1	NC6-P108-16	149
5-1437684-2	NC6-P108-17	149
5-1437684-3	NC6-P108-18	149
5-1437684-4	4DB-P108-24	143
5-1437684-5	4DB-P108-26	143
5-1437684-6	4DB-P108-28	143
5-1437684-7	4DB-P108-30	143
5-1437684-8	4DB-P207-03	143
5-1437684-9	4DB-P207-05	143
5-1437684-0	4DB-P207-06	143
5-1437685-0	6TK2-48	211
5-1437685-2	6TK2-5	211
5-1437685-5	6TK2-6	211
5-1437685-6	6TK2D-12	211
5-1437685-7	6TK2D-48	211
5-1437685-8	6TK2D-6	211
5-1546158-0	6PCV-04-1268	129
5-1546158-3	6PCV-05-1267	129
5-1546399-0	6PCR-26-008	129
5-1546399-1	6PCR-27-008	129
5-1546399-2	6PCR-28-008	129
5-1546700-0	JC6-Q408-12	147
5-1546700-1	JC6-Q408-13	147
5-1546700-2	JC6-Q408-14	147
5-1546700-3	JC6-Q408-15	147
5-1546700-4	JC6-Q408-16	147
5-1546700-5	JC6-Q408-17	147
5-1546700-6	JC6-Q408-18	147
5-1546700-7	JC6-Q408-19	147
5-1546700-8	JC6-Q408-20	147
5-1546700-9	JC6-Q408-21	147
5-1546701-0	JC6-T407-13	147
5-1546701-1	JC6-T407-14	147
5-1546701-2	JC6-T407-15	147
5-1546701-3	JC6-T407-16	147
5-1546701-4	JC6-T407-17	147
5-1546701-5	JC6-T407-18	147
5-1546701-6	JC6-T407-19	147
5-1546701-7	JC6-T407-20	147
5-1546701-8	JC6-T407-21	147

Tyco Part Number	BUCHANAN Part Number	Page Number
5-1546701-9	JC6-T407-22	147
5-1546702-0	JC6-W308-15	147
5-1546702-1	JC6-W308-16	147
5-1546702-2	JC6-W308-17	147
5-1546702-3	JC6-W308-18	147
5-1546702-4	JC6-W308-19	147
5-1546702-5	JC6-W308-20	147
5-1546702-6	JC6-W308-21	147
5-1546702-7	JC6-W308-22	147
5-1546702-8	JC6-W308-23	147
5-1546702-9	JC6-W307-05	147
5-1546703-0	JC6-W107-16	147
5-1546703-1	JC6-W107-17	147
5-1546703-2	JC6-W107-18	147
5-1546703-3	JC6-W107-19	147
5-1546703-4	JC6-W107-20	147
5-1546703-5	JC6-W107-21	147
5-1546703-6	JC6-W107-22	147
5-1546703-7	JC6-W107-23	147
5-1546703-8	JC6-W107-24	147
5-1546703-9	JC6-W107-25	147
6-0796985-0	JC6-P208-17	147
6-0796985-1	JC6-P208-19	147
6-0796985-2	JC6-P208-20	147
6-0796985-3	JC6-P208-21	147
6-0796985-4	JC6-P208-22	147
6-0796985-5	JC6-P208-23	147
6-0796985-6	JC6-P207-07	147
6-0796985-7	JC6-P207-11	147
6-0796985-8	JC6-P207-12	147
6-0796985-9	JC6-P207-13	147
6-1437381-0	4B112P	290
6-1437382-0	B112C	290
6-1437382-1	B112CH	290
6-1437382-2	B112CN	290
6-1437382-3	B112CT	290
6-1437382-4	B112H	290
6-1437382-5	B112HN	290
6-1437382-6	B112N	290
6-1437382-7	B112S	290
6-1437382-8	B112S	295
6-1437382-9	B112SH	290
6-1437389-0	DP0241	261
6-1437389-1	DP0243	261
6-1437389-2	DP0311	282
6-1437389-3	DP0312	282
6-1437390-0	P0242	260
6-1437390-2	P0243-BU	260
6-1437390-3	P0248	260
6-1437390-4	P0250	260,261
6-1437390-5	P241	260
6-1437390-6	P242	260
6-1437390-7	P243	260
6-1437390-8	P248	260
6-1437390-9	P250	260,261
6-1437393-4	P0625	244
6-1437401-0	SSB3FP231202	162
6-1437401-1	SSB3FP240202	162
6-1437401-2	SSB3FP250202	162
6-1437402-0	QC13	176
6-1437402-1	QC14	176
6-1437402-2	QC15-BU	176
6-1437402-4	QC22	191
6-1437402-5	QC23	176,191
6-1437402-6	QC24	176,191
6-1437402-7	QC25	176,194
6-1437402-9	QC40-BU	176
6-1437404-0	USB3B09S	162
6-1437404-1	USB3B10S	162
6-1437404-2	USB3B11S	162
6-1437404-3	USB3B12S	162
6-1437404-4	USB3B14S	162
6-1437406-0	PSB4KC12A	191
6-1437406-1	PSB4KC12S	191
6-1437406-2	PSB4KC14A	191
6-1437406-3	PSB4KC14S	191
6-1437406-4	PSB4KC16A	191
6-1437406-5	PSB4KC16S	191
6-1437406-6	PSB4KC18A	191
6-1437406-7	PSB4KC18S	191
6-1437406-8	PSB4KC20A	191
6-1437406-9	PSB4KC20S	191
6-1437407-2	RSB6VP031201	172
6-1437407-3	RSB6VP031202	172
6-1437407-6	RSB6VP031209	172
6-1437407-7	RSB6VP031225	172
6-1437407-8	RSB6VP031902	172
6-1437407-9	RSB6VP041201	172
6-1437410-1	PCB2B06S	184
6-1437410-2	PCB2B08A	184
6-1437410-3	PCB2B08S	184
6-1437410-4	PCB2B09S	184
6-1437410-5	PCB2B10A	184
6-1437410-6	PCB2B10S	184
6-1437410-7	PCB2B12A	184

Note: All part numbers are RoHS Compliant.

Tyco Part Number	BUCHANAN Part Number	Page Number
6-1437410-8	PCB2B12S	184
6-1437410-9	PCB2B15A	184
6-1437415-3	SSB7CE04030	152
6-1437415-4	SSB7CF130300	152
6-1437415-5	SSB7CG020326	152
6-1437415-6	SSB7CG050301	152
6-1437415-7	SSB7CG050304	152
6-1437415-8	SSB7CG05030411	152
6-1437416-0	SSB7RP02020211	152
6-1437416-1	SSB7RP030203	152
6-1437416-2	SSB7RP030204	152
6-1437416-3	SSB7RP040201	152
6-1437416-4	SSB7RP04020211	152
6-1437416-5	SSB7RP040204	152
6-1437416-6	SSB7RP050202	152
6-1437416-7	SSB7RP060204	152
6-1437416-8	SSB7RP080202	152
6-1437416-9	SSB7RP090202	152
6-1437418-0	J74	177,194
6-1437418-1	J75	177,194
6-1437418-2	PC18	190
6-1437418-4	PCBJ1	190
6-1437418-5	PCBJ2	190
6-1437418-6	QC21	191
6-1437644-0	QC6-245-4	191
6-1437644-1	QC6-290-4	191
6-1437644-2	QC6-45-3	191
6-1437644-3	QC6-45-3-C	191
6-1437644-4	QC6-45-4	191
6-1437644-5	QC6-90-3	191
6-1437644-6	QC6-90-4	191
6-1437644-7	QC8-180-4	191
6-1437644-8	QC8-45-4	191
6-1437644-9	QC8-90-4	191
6-1437648-7	4PCV-04-006	125
6-1437652-7	6PCV-04-006	129
6-1437661-0	TC8-08-PFH	174
6-1437661-1	TC8-10-PF	174
6-1437661-2	TC8-10-PFH	174
6-1437661-3	TC8-11-PFH	174
6-1437661-4	TK4	211
6-1437661-7	TKD-09-PF	174
6-1437661-9	TC6-07-PF	174
6-1437664-2	NC6-P106-04	149
6-1437664-3	NC6-P102-12	149
6-1437664-4	NC6-P102-02	149
6-1437667-0	4DB-P208-02	143
6-1437667-1	4DB-P208-04	143
6-1437667-2	4DB-P208-22	143
6-1437667-3	4DB-R107-02	143
6-1437667-4	4DB-R107-03	143
6-1437667-5	4DB-R107-04	143
6-1437667-6	4DB-R107-06	143
6-1437667-7	4DB-R107-07	143
6-1437667-8	4DB-R107-08	143
6-1437685-8	TK2-2-AG	211
6-1437685-9	TK2-2-AG	211
6-1546158-1	6PCV-10-003	129
6-1546158-2	6PCV-10-1269	129
6-1546700-0	JC6-Q408-22	147
6-1546700-1	JC6-Q408-23	147
6-1546700-2	JC6-Q408-24	147
6-1546700-3	JC6-Q408-25	147
6-1546700-4	JC6-Q408-03-187	147
6-1546701-0	JC6-T407-23	147
6-1546701-1	JC6-T407-24	147
6-1546701-2	JC6-T407-25	147
6-1546701-3	JC6-T408-02	147
6-1546701-4	JC6-T408-03	147
6-1546701-5	JC6-T408-06	147
6-1546701-6	JC6-T408-07	147
6-1546701-7	JC6-T408-08	147
6-1546701-8	JC6-T408-10	147
6-1546701-9	JC6-T408-11	147
6-1546702-0	JC6-W307-11	147
6-1546702-1	JC6-W307-12	147
6-1546702-2	JC6-W307-14	147
6-1546702-3	JC6-W307-15	147
6-1546702-4	JC6-W307-16	147
6-1546702-5	JC6-W307-17	147
6-1546702-6	JC6-W307-18	147
6-1546702-7	JC6-W307-19	147
6-1546702-8	JC6-W307-20	147
6-1546702-9	JC6-W307-21	147
7-0796985-0	JC6-P207-14	147
7-0796985-1	JC6-P207-15	147
7-0796985-2	JC6-P207-16	147
7-0796985-3	JC6-P207-17	147
7-0796985-4	JC6-P207-18	147
7-0796985-5	JC6-P207-19	147
7-0796985-6	JC6-P207-21	147
7-0796985-7	JC6-P207-22	147
7-0796985-8	JC6-P207-23	147
7-0796985-9	JC6-P107-15	147
7-1437381-7	51-BU	291

Tyco Part Number	BUCHANAN Part Number	Page Number
7-1437381-8	53-BU	275,279
7-1437382-0	B112T	290
7-1437382-5	C102-BU	291
7-1437382-6	C104-BU	291
7-1437382-7	C106-BU	291
7-1437382-8	C108-BU	291
7-1437382-9	C112-BU	291
7-1437389-1	DP125	246
7-1437402-0	QC41	176,194
7-1437402-1	QC42	176,194
7-1437402-2	QC43	176,194
7-1437402-3	QC44	176,194
7-1437402-4	QC45	176,194
7-1437402-5	QC70	176
7-1437402-6	QC71	176
7-1437402-7	QC72	176
7-1437402-8	QC73	176
7-1437402-9	QC74	176
7-1437406-0	PSB4KC22A	191
7-1437406-1	PSB4KC24A	191
7-1437406-2	PSB4KC24S	191
7-1437406-3	PSB4KC26A	191
7-1437407-0	RSB6VP041202	172
7-1437407-2	RSB6VP041203	172
7-1437407-3	RSB6VP051201	172
7-1437407-4	RSB6VP051202	172
7-1437407-5	RSB6VP051203	172
7-1437407-7	RSB6VP061201	172
7-1437407-9	RSB6VP061202	172
7-1437410-0	PCB2B15S	184
7-1437410-1	PCB2B16A	184
7-1437410-2	PCB2B16S	184
7-1437410-3	PCB2B18A	184
7-1437410-4	PCB2B18S	184
7-1437410-5	PCB2B22A	184
7-1437410-6	PCB2B22S	184
7-1437410-7	PCB2B24A	184
7-1437410-8	PCB2B28A	184
7-1437410-9	PCB2B28S	184
7-1437415-0	SSB7CG050326	152
7-1437415-2	SSB7CG060302	152
7-1437415-3	SSB7CG090301	152
7-1437415-4	SSB7CG090304	152
7-1437415-5	SSB7CG09032224	152
7-1437415-6	SSB7CG140301	152
7-1437415-7	SSB7CG160304	152
7-1437415-8	SSB7FE020202	152
7-1437415-9	SSB7FE030501	152
7-1437416-0	SSB7RP120202	152
7-1437416-1	SSB719030402	152
7-1437416-2	SSB71E020101	152
7-1437416-3	SSB71E040502	152
7-1437416-4	SSB71E050722	152
7-1437416-5	SSB71E060104	152
7-1437416-6	SSB71E070101	152
7-1437416-7	SSB71E070103	152
7-1437416-8	SSB71E070104	152
7-1437416-9	SSB71E160722	152
7-1437418-0	3C1N10	175
7-1437426-1	B51C8U02T	91
7-1437426-2	B51C8U03T	91
7-1437426-4	B51C8U04T	91
7-1437426-5	B51C8U05T	91
7-1437426-7	B51C8U06T	91
7-1437426-8	B51C8U07T	91
7-1437644-1	TC2-02-AG	174
7-1437644-2	TC2-03-AG	174
7-1437644-3	TC2-05-AG	174
7-1437644-4	TC2-06-AG	174
7-1437644-5	TC2-08-AG	174
7-1437644-6	TC2-10-AG	174
7-1437644-7	TC2-13-AG	174
7-1437644-8	TC3-02-AG	174
7-1437644-9	TC3-03-AG	174
7-1437661-0	TC6-09-PF	174
7-1437661-2	TC4-12-PFH	174
7-1437661-4	TC6-11-PFH	174
7-1437661-5	TC8-02-PFH	174
7-1437661-6	TC8-09-PF	174
7-1437661-7	TC4-14-PFH	174
7-1437661-8	TC4-15-PFH	174
7-1437661-9	TC8-09-PFH	174
7-1437662-8	BC6-P108-18	134
7-1437667-0	4DB-R107-11	143
7-1437667-1	4DB-R108-02	143
7-1437667-2	4DB-R108-03	143
7-1437667-3	4DB-R108-04	143
7-1437667-4	4DB-R108-05	143
7-1437667-5	4DB-R108-06	143
7-1437667-7	4DB-R108-15	143
7-1437667-8	4DB-R108-20	143
7-1437667-9	4DB-R207-02	143
7-1437685-0	TK2-3-PG	211
7-1437685-3	TK2-4-AG	211

Tyco Part Number	BUCHANAN Part Number	Page Number
7-1437685-6	TK2-48-AG	211
7-1546158-6	6PCV-20-1359	129
7-1546158-7	6PCV-20-1360	129
7-1546158-8	6PCV-20-1361	129
7-1546158-9	6PCV-20-1362	129
7-1546701-0	JC6-T408-12	147
7-1546701-1	JC6-T408-13	147
7-1546701-2	JC6-T408-14	147
7-1546701-3	JC6-T408-15	147
7-1546701-4	JC6-T408-16	147
7-1546701-5	JC6-T408-17	147
7-1546701-6	JC6-T408-18	147
7-1546701-7	JC6-T408-19	147
7-1546701-8	JC6-T408-20	147
7-1546701-9	JC6-T408-22	147
7-1546702-0	JC6-W307-22	147
7-1546702-1	JC6-W307-23	147
7-1546702-2	JC6-W208-03	147
7-1546702-3	JC6-W208-08	147
7-1546702-4	JC6-W208-09	147
7-1546702-5	JC6-W208-10	147
7-1546702-6	JC6-W208-11	147
7-1546702-7	JC6-W208-13	147
7-1546702-8	JC6-W208-14	147
7-1546702-9	JC6-W208-15	147
7-796602-6	SSB7FG040104	152
796602-4	SSB7FM060104	152
796602-9	SSB7FM061504	152
796609-1	RSB6VP061903	172
796632-1	USB3B13S	162
796633-1	RSB6B05S	163
796633-2	RSB6B07S	163
796633-3	RSB6B08S	163
796633-4	RSB6B09S	163
796658-2	4DB-P108-21	144
796756-6	7B106H	190
8-0796985-0	JC6-P107-17	147
8-0796985-1	JC6-P107-18	147
8-0796985-2	JC6-P107-19	147
8-0796985-3	JC6-P107-21	147
8-0796985-4	JC6-P107-22	147
8-0796985-5	JC6-P107-23	147
8-0796985-6	JC6-P107-24	147
8-0796985-7	JC6-P107-25	147
8-0796985-8	JC6-T305-20-205	147
8-1437381-0	55-BU	254,262,270,275, 279,284,287 154,262,270
8-1437381-1	56	154,262,270
8-1437381-4	5B102	290
8-1437381-5	5B104	290
8-1437381-7	5B106	290
8-1437381-8	5B108	290
8-1437402-0	QC75	176
8-1437407-0	RSB6VP06120212AF	172
8-1437407-2	RSB6VP061203	172
8-1437407-3	RSB6VP061203NN60	172
8-1437407-4	RSB6VP061209	172
8-1437407-5	RSB6VP071201	172
8-1437407-6	RSB6VP071202	172
8-1437407-7	RSB6VP071902	172
8-1437407-8	RSB6VP081202	172
8-1437407-9	RSB6VP08120221	172
8-1437410-0	PCB2B30A	184
8-1437410-1	PCB2B30S	184
8-1437410-2	PCB2B36A	184
8-1437410-3	PCB2B36S	184
8-1437410-4	PCB2B43A	184
8-1437410-5	PCB2B43S	184
8-1437410-7	PCB3A06A	185
8-1437410-8	PCB3A06S	185
8-1437410-9	PCB3A08A	185
8-1437415-0	SSB7FE140204	152
8-1437415-1	SSB7FE180501	152
8-1437415-2	SSB7FF030101	152
8-1437415-3	SSB7FF041503	152
8-1437415-4	SSB7FF101501	152
8-1437415-5	SSB7FG020209	152
8-1437415-6	SSB7FG030103	152
8-1437415-7	SSB7FG050103	152
8-1437415-8	SSB7FG050202	152
8-1437415-9	SSB7FG060701	152
8-1437416-0	SSB7TE180501	152
8-1437416-1	SSB7TE180722	152
8-1437416-2	SSB7TF020502	152
8-1437416-3	SSB7TF030502	152
8-1437416-4	SSB7TF040502	152
8-1437416-5	SSB7TF060102	152
8-1437416-6	SSB7TF060501	152
8-1437416-7	SSB7TF060502	152
8-1437416-8	SSB7TF070502	152
8-1437416-9	SSB7TF080502	152
8-1437426-0	B51C8U01T	91
8-1437426-1	B51C8U01T	91
8-1437426-3	B51C8U10T	91
8-1437426-6	B51C8U11T	

Note: All part numbers are RoHS Compliant.

Tyco Part Number	BUCHANAN Part Number	Page Number
8-1437426-7	B51C8U12T	91
8-1437644-0	TC3-04-AG	174
8-1437644-1	TC3-06-AG	174
8-1437644-2	TC3-07-AG	174
8-1437644-3	TC3-08-AG	174
8-1437644-4	TC3-12-AG	174
8-1437644-5	TC3-20-AG	174
8-1437648-0	4PCV-06-006	125
8-1437657-0	8PCV-04-006	137
8-1437667-0	4DB-R207-05	143
8-1437667-1	4DB-R208-06	143
8-1437667-3	4DB-S208-02	143
8-1437667-4	4DB-S208-06	143
8-1437667-5	4DB-S208-12	143
8-1437667-6	4DB-W108-06	143
8-1437667-7	4DB-W108-12	143
8-1437667-8	4DB-W108-18	143
8-1437667-9	4DB-W108-20	143
8-1437685-3	TK2-6-AG	211
8-1437685-8	TK2D-12	211
8-1546158-0	6PCV-20-323	129
8-1546701-0	JC6-T408-23	147
8-1546701-1	JC6-T408-25	147
8-1546702-0	JC6-W208-16	147
8-1546702-1	JC6-W208-17	147
8-1546702-2	JC6-W208-18	147
8-1546702-3	JC6-W208-19	147
8-1546702-4	JC6-W208-20	147
8-1546702-5	JC6-W208-21	147
8-1546702-6	JC6-W208-22	147
8-1546702-7	JC6-W208-23	147
8-1546702-8	JC6-W208-03-188	147
8-1546702-9	JC6-W307-03-190	147
8-796602-0	SSB7CF03035611	152
8-796602-1	SSB7CE120302	152
8-796602-2	SSB7FG090209	152
8-796602-3	SSB7TM030502	152
8-796602-4	SSB7FP041602	152
8-796602-5	SSB7FP041602_23	152
8-796602-6	SSB7CF030302_23	152
8-796602-7	SSB7FF110102	152
8-796602-8	SSB7FP070402	152
8-796602-9	SSB7CG030321	152
9-1437381-0	5B112	290
9-1437381-1	60	246,253,262, 270,275,279,284
9-1437381-1	60-BU	287
9-1437381-2	60B36	246,253,262,270, 275,279,284,287
9-1437381-5	61	247,253,262,270, 275,279,284,287
9-1437381-7	62	247,253,262,270, 275,279,284,287
9-1437381-8	63-BU	246,253,262,270, 275,279,284,287
9-1437381-9	64	246,253,262,270, 275,279,284,287
9-1437382-0	CL101	291
9-1437382-2	CS102	291
9-1437382-3	CS104	291
9-1437382-4	CS106	291
9-1437382-5	CS108	291
9-1437382-6	CS112	291
9-1437407-1	RSB6VP081203	172
9-1437407-2	RSB6VP081209	172
9-1437407-3	RSB6VP081901	172
9-1437407-4	RSB6VP091202	172
9-1437407-7	RSB6VP101201	172
9-1437407-8	RSB6VP1012011	172
9-1437407-9	RSB6VP10120121	172
9-1437410-0	PCB3A08S	185
9-1437410-1	PCB3A10A	185
9-1437410-2	PCB3A10S	185
9-1437410-3	PCB3A12A	185
9-1437410-4	PCB3A12S	185
9-1437410-5	PCB3A15A	185
9-1437410-6	PCB3A15S	185
9-1437410-7	PCB3A16A	185
9-1437410-8	PCB3A16S	185
9-1437410-9	PCB3A18A	185
9-1437415-0	SSB7FG080201	152
9-1437415-1	SSB7FG150202	152
9-1437415-2	SSB7FG160201	152
9-1437415-3	SSB7FM030201	152
9-1437415-4	SSB7FM030202	152
9-1437415-5	SSB7FM060201	152
9-1437415-6	SSB7FM06020211	152
9-1437415-7	SSB7FM070602	152
9-1437415-8	SSB7FM081301	152
9-1437416-0	SSB7TF140501	152
9-1437416-1	SSB7TF200501	152
9-1437416-2	SSB7TG020502	152
9-1437416-3	SSB7TG020503	152
9-1437416-4	SSB7TG030502	152
9-1437416-5	SSB7TG040101	152

Tyco Part Number	BUCHANAN Part Number	Page Number
9-1437416-6	SSB7TG070101	152
9-1437416-7	SSB7TG080101	152
9-1437416-8	SSB7TG080502	152
9-1437416-9	SSB7TG100101	152
9-1437426-0	B51C8U13T	91
9-1437426-1	B51C8U14T	91
9-1437426-2	B51C8U15T	91
9-1437644-0	TC8-09-AG	174
9-1437644-2	TC9-02-AG	174
9-1437644-3	TC9-03-AG	174
9-1437644-4	TC9-04-AG	174
9-1437644-6	TC9-05-AG	174
9-1437644-8	TC9-06-AG	174
9-1437644-9	TC9-07-AG	174
9-1437652-5	6PCV-06-006	129
9-1437662-6	BC6-T408-02	134
9-1437667-0	4DB-W207-02	143
9-1437667-1	4DB-W207-03	143
9-1437667-2	4DB-W207-04	143
9-1437667-3	4DB-W208-02	143
9-1437667-4	4DB-W208-03	143
9-1437667-5	4DB-W208-04	143
9-1437667-6	4DB-W208-08	143
9-1437667-7	4DB-W208-09	143
9-1437667-8	4DB-W208-14	143
9-1437685-1	TK2D-48	211
9-1437685-2	TK2D-6	211
9-1546119-9	4PCV-08-235	125
9-1546158-1	6STR-04-263	129
9-1546158-2	6STR-04-392	129
9-1546158-6	6STR-07-1228	129
9-796602-0	SSB7FP040102	152
9-796602-1	SSB7FP04010211	152
9-796602-2	SSB7FP270201	152
9-796602-3	SSB7FG050502	152
9-796602-5	SSB7FG100502	152
9-796602-6	SSB7CG030302	152
9-796602-7	SSB7FG040702	152
9-796602-8	SSB7FG040102	152

Note: All part numbers are RoHS Compliant.

BUCHANAN Part Number	Tyco Part Number	Page Number
—	46121	109
—	47386	109
—	47387	109
—	59239	109
—	160402	109
—	165046	109
—	165049	109
—	165075	109
—	165085	109
—	165142	109
—	165167	109
—	165168	109
—	165171	109
—	165172	109
—	165514	109
—	282805	81
—	282807	81
—	282808	79
—	282809	79
—	282811	66
—	282812	59
—	282814	66
—	282815	61
—	282816	64
—	282817	64
—	282818	65
—	282819	65
—	282821	57
—	282822	51
—	282824	57
—	282825	52
—	282826	55
—	282827	55
—	282828	56
—	282830	86
—	282831	88
—	282834	8
—	282835	8
—	282836	11
—	282837	11
—	282838	16
—	282839	18
—	282841	13
—	282842	17
—	282843	18
—	282844	14
—	282845	15
—	282847	26
—	282848	27
—	282849	27
—	282851	22
—	282852	24
—	282853	25
—	282854	23
—	282855	23
—	282856	12
—	282857	14
—	282858	17
—	282860	15
—	282861	16
—	282862	21
—	282863	22
—	282867	23
—	282868	32
—	282869	33
—	282873	34
—	282876	35
—	282877	36
—	282880	38
—	282881	39
—	282884	41
—	282888	32
—	282897	37
—	282900	38
—	282901	40
—	282905	42
—	282906	43
—	282909	34
—	282913	35
—	282916	36
—	282917	37
—	282920	39
—	282921	40
—	282924	41
—	282925	42
—	282928	107
—	282929	107
—	282930	107
—	282959	78
—	282961	62
—	282962	62
—	282963	53
—	282964	53
—	282965	63
—	282966	63

BUCHANAN Part Number	Tyco Part Number	Page Number
—	282967	54
—	282969	108
—	282970	108
—	284008	67
—	284040	82
—	284041	83
—	284042	84
—	284043	84
—	284044	84
—	284045	84
—	284046	82
—	284047	83
—	284049	84
—	284051	84
—	284052	70
—	284053	70
—	284056	68
—	284061	71
—	284065	68
—	284093	20
—	284094	21
—	284391	9
—	284392	10
—	284410	28
—	284414	19
—	284415	19
—	284506	76
—	284507	76
—	284509	80
—	284510	73
—	284511	73
—	284512	58
—	284513	58
—	284514	49
—	284515	49
—	284516	45
—	284517	50
—	284518	50
—	284519	45
—	284539	47
—	284541	47
—	284627	107
—	284628	107
—	346218	189
—	346220	188,190,193,194
—	347528	189
—	347529	189
—	347601	189
—	539660	111
—	539661	111
—	546211	51
—	785730	108
—	796634	77
—	796635	77
—	796636	52
—	796637	52
—	796638	61
—	796639	61
—	796640	77
—	796641	51,77
—	796642	51
—	796643	51
—	796644	60
—	796645	60
—	796691	12
—	796682	12
—	796683	12
—	796684	20
—	796688	26
—	796689	26
—	796690	26
—	796691	32
—	796692	33
—	796693	76
—	796694	49
—	796695	58
—	796696	77
—	796697	51
—	796698	59
—	796699	51
—	796700	60
—	796704	17
—	796739	29
—	796740	29
—	796741	30
—	796748	20
—	796858	74
—	796859	74
—	796861	75
—	796863	75
—	796864	48
—	796866	48
—	796867	46
—	796911	13
—	796949	13

BUCHANAN Part Number	Tyco Part Number	Page Number
—	796980	54
—	796981	78
—	796984	33
—	966067	110
—	966144	110
—	1241000	111
—	1241001	111
—	1241002	111
—	1241003	111
—	1241004	111
—	1437425	136,141
—	1437649	124,178
—	1437651	128,134,147,149,178
—	1437667	143,178
—	1447425	178
—	1447429	178
—	1546018	86
—	1546050	108
—	1546051	108
—	1546062	15
—	1546073	22
—	1546074	26
—	1546105	83
—	1546106	68
—	1546108	77
—	1546109	61
—	1546110	61
—	1546111	52
—	1546118	82
—	1546122	83
—	1546173	87
—	1546179	59
—	1546208	77
—	1546209	60
—	1546210	59
—	1546211	51
—	1546212	51
—	1546213	52
—	1546215	8
—	1546216	11
—	1546217	11
—	1546218	13
—	1546219	26
—	1546220	26
—	1546222	33
—	1546223	82
—	1546224	83
—	1546225	20
—	1546226	86
—	1546227	9
—	1546231	83
—	1546233	37
—	1546237	70
—	1546306	156
—	1546307	156
—	1546310	160
—	1546311	160
—	1546477	157
—	1546481	157
—	1546551	9
—	1546552	10
—	1546625	82
—	1546657	139,142
—	1546670	158,177
—	1546671	158,177
—	1546734	146
—	1546833	132
—	1546857	82
—	1546927	127
—	1546931	85,86,87
—	1546932	85,88
—	1546935	84
—	1776038	61
—	1776057	158,176
—	1776090	153,176
—	1776110	158
—	1776112	9,16
—	1776113	10
—	1776118	11
—	1776120	20
—	1776121	21
—	1776123	18
—	1776124	24
—	1776125	25
—	1776126	13
—	1776130	49
—	1776131	50
—	1776132	45
—	1776133	45
—	1776134	58
—	1776135	58
—	1776136	47
—	1776137	47
—	1776138	51
—	1776139	52

Note: All part numbers are RoHS Compliant.

BUCHANAN Part Number	Tyco Part Number	Page Number
—	1776140	59
—	1776141	61
—	1776142	57
—	1776143	57
—	1776144	66
—	1776145	66
—	1776146	51
—	1776147	52
—	1776148	60
—	1776149	53
—	1776150	54
—	1776152	63
—	1776153	53
—	1776154	54
—	1776155	63
—	1776156	55
—	1776157	56
—	1776158	64
—	1776159	65
—	1776160	55
—	1776161	56
—	1776162	64
—	1776163	65
—	1776164	68
—	1776165	68
—	1776166	71
—	1776167	71
—	1776168	69
—	1776169	69
—	1776170	72
—	1776171	72
—	1776173	159,160,176
—	1776174	159,176
—	1776244	97
—	1776252	99
—	1776258	99
—	1776259	106
—	1776260	106
—	1776261	105
—	1776262	105
—	1776263	100
—	1776266	97
—	1776267	95
—	1776269	97
—	1776275	96
—	1776279	102
—	1776280	100
—	1776281	102
—	1776282	102
—	1776283	102
—	1776489	100
—	1776491	98
—	1776492	94
—	1776504	97
—	1776538	84
—	1776544	159
—	1776555	95
—	1776803	176
—	1776843	176
—	1776860	176
—	1776886	30
—	1811398	103
—	1811444	103
—	1811957	103
01	—	153,154,170,172
02	—	153,154,170,172,173
03	—	153,154,172
04	—	153,170,172
05	—	153
06	—	154
07	—	154
08	—	154
09	—	154,172,173
10	1437381-1	246
11	1437381-4	154,169,172, 246,247,253,262
12	1437381-8	154,166,169,172, 173,246,253,262
13	1-1437381-0	154,169,172,247
14	1-1437381-1	154,169,172,247
15	1-1437381-2	154,169,172,247
16	1-1437381-3	154,169,172,247
17	—	172
18	—	172
20	—	154
21	—	154
22	—	154
23	—	154
24	1-1437381-8	154
25	—	154
26	—	154
27	1-1437381-9	154
28	—	154
29	—	154
30	—	154

BUCHANAN Part Number	Tyco Part Number	Page Number
31	—	154
32	2-1437397-2	154,287
33	—	154
34	—	154
35	—	154
36	—	154
37	—	154
38	—	154
39	—	154
40	—	154
41	—	154
42	—	154
43	5-1437381-5	154
44	—	154
45	—	154
46	—	154
47	—	154
48	—	154
49	—	154
50	—	154
51	—	154
52	4-1437391-1	154,275
53	—	154
54	—	154
55	—	154
56	8-1437381-1	154,262,270
60	9-1437381-1	246,253,262, 270,275,279,284
61	9-1437381-5	247,253,262,270, 275,279,284,287
62	9-1437381-7	247,253,262,270, 275,279,284,287
64	9-1437381-9	246,253,262,270, 275,279,284,287
66	1437382-1	254,275
67	1437382-2	246,253,262,270, 275,279,284,287
68	1437382-3	246,247,253,262, 270,275,279,284,287
70	1437382-6	253
71	1-1437382-2	254
73	1-1437382-3	254
74	1-1437382-4	254
75	1-1437382-5	262
76	1-1437382-6	275
80	—	154
84	2-1437382-5	253
115	—	294
120	2-1437392-1	246
211	1437390-1	268
211	2-1437390-7	268,294
212	1437390-3	268
212	2-1437390-8	268,294
213	1437390-5	268
213	2-1437390-9	268,294
218	1437390-7	268
218	3-1437390-0	268,294
221	1437390-8	268
221	3-1437390-1	268
222	1437390-9	268
223	1-1437390-2	268
228	1-1437390-3	268
230	1-1437390-4	268,269
241	1-1437390-6	260
241	3-1437390-9	260,294
242	2-1437390-0	260
242	4-1437390-0	260,294
243	2-1437390-1	260
243	4-1437390-1	260,294
248	2-1437390-4	260
248	4-1437390-2	260,294
250	2-1437390-5	260
250	4-1437390-3	260,294
311	1437397-1	282,294
312	1437397-2	282
318	1437397-3	282
330	1437397-5	282
341	1437397-6	286
341	2-1437397-5	286,294
342	1437397-7	286
342	2-1437397-6	286,294
348	1437397-8	286
348	2-1437397-7	286,294
351	1437397-9	286
351	2-1437397-8	286,294
352	1-1437397-0	286
352	3-1437397-0	286,294
358	1-1437397-2	286
358	3-1437397-1	286,294
361	1-1437397-4	294
361	3-1437397-2	294
362	1-1437397-5	286
368	1-1437397-6	286
368	1-1437397-6	294
371	1-1437397-7	282

BUCHANAN Part Number	Tyco Part Number	Page Number
372	1-1437397-8	283,294
378	1-1437397-9	283,294
380	2-1437397-0	282,283
416	1437396-4	278,294
417	1437396-5	278,295
814	1437395-2	274
921	1546144-1	250
921	1546143-1	250,295
924	1546147-1	250
924	1546148-1	250,295
925	1546234-1	250
925	1546235-1	250,295
927	1546149-1	250
927	1546150-1	250
929	1546151-1	251
929	1546152-1	251,295
930	1546163-1	250,251
930	1546164-1	250,251
2400	1447889-1	269
74100	4-1437393-1	254
0711ERT	1546706-1	252
0721ERT	1437394-9	252
0724ERT	1-1433794-1	252
0725ERT	1-1437394-6	252
0730ERT	2-1437394-0	252
1000BZM	1437387-1	237
1003SI	—	215
1003SI1	1-1776309-1	229
1003SI1DS	1776309-1	229
1003SI1DS	1437429-1	136,141
1003SI2	1-1776309-2	229
1003SI2DS	1776309-2	229
1003SI3	1-1776309-3	229
1003SI3DS	—	229
1003SI3E	1776309-3	229
1003SI3EDS	1776309-4	229
1003SI4	1-1776309-4	229
1003SI4DS	—	229
1003SI4E	—	229
1003SI4EDS	—	229
1003SI5	1-1776309-5	229
1003SI5	1776309-5	229
1003SI5DS	—	229
1003SI5E	—	229
1003SI5EDS	—	229
105-BU	1-1437392-7	246,294
110-BU	1-1437392-8	246
115-BU	1437381-5	246
11R-SOCKET	1437683-1	210
11S-SOCKET	1437661-1	210
125-BU	2-1437392-3	246,294
130-BU	2-1437392-5	246
14S-SOCKET	1437683-3	210
1500BZM	—	237
2000BZM	1437387-2	237
202BS	1437683-4	207
202BSL	1776631-1	207
204BS	1437683-5	207
204BSL	1776632-1	207
208BR	1437683-6	205
208BRL	1776633-1	205
211BR	1437683-7	206
211BRL	1776634-1	206
211BS	1437683-8	209
211BSL	1776630-1	209
214BS	1437683-9	208
214BSL	1776636-1	208
218BR	1-1437683-0	205
218BRL	1776617-1	205
21S-SOCKET	1-1437683-1	210
222-BU	3-1437390-3	268,294
223-BU	3-1437390-6	268
228-BU	1-1437381-5	268
22PCB	1437684-1	203,204
22PCBL	1776614-1	203,204
230-BU	1-1437381-7	268,269
230BZM	1437387-3	237
23-BU	1-1437382-6	262,270
2B102	2-1437381-0	290
2B102N	2-1437381-1	290
2B104	2-1437381-2	290
2B104N	2-1437381-3	290
2B104T	2-1437381-4	290
2B104TN	2-1437381-5	290
2B106	2-1437381-6	290
2B106H	2-1437381-7	290
2B106N	2-1437381-8	290
2B106T	2-1437381-9	290
2B108	3-1437381-0	290
2B108N	3-1437381-1	290
2B108TN	3-1437381-2	290
2B112	3-1437381-3	290
2B112HN	3-1437381-4	290
2B112N	3-1437381-5	290
2B112T	3-1437381-6	290

Note: All part numbers are RoHS Compliant.

BUCHANAN Part Number	Tyco Part Number	Page Number
2B112TN	3-1437381-7	290
2EHDR	—	60,61
2ESDV	—	77
2M08DP	1437684-2	202
2M08DPL	1776599-1	202
2M09DSML	1437684-3	200
2M09DSML	1546693-1	200
2M10FC	1437684-5	201
2M10FCL	1776615-1	201
2M14FC	1437684-6	201
2M14FCL	1776616-1	201
2M15DSM	1437684-7	200
2M15DSML	1546694-1	200
2M16DP	1437684-8	202
2M16DPL	1776600-1	202
2M16DPZ	1-1437684-0	202
2M16DPZL	1776624-1	202
2M16FC	1-1437684-1	200
2M16FCL	1776625-1	201
2M20FC	1-1437684-2	200
2M20FCL	1776626-1	201
2M22PCB	1-1437684-3	203,204
2M22PCBL	1776627-1	203,204
2M24DP	1-1437684-4	202
2M24DPL	1776602-1	202
2M24DPZ	1-1437684-5	202
2M24DPZL	1776628-1	202
2M25DSF	1-1437684-7	200
2M25DSM	1-1437684-8	200
2M25DSML	1776224-1	200
2M26FC	1-1437684-9	201
2M26FCL	1776630-1	201
2M34FC	2-1437684-0	201
2M34FCL	1776638-1	201
2M36TELP	—	199
2M36TELP	—	199
2M36TELS	2-1437684-1	199
2M36TELSL	1776826-1	199
2M37DSF	2-1437684-2	200
2M37DSM	2-1437684-3	200
2M37DSML	1776612-1	200
2M40DP	2-1437684-4	202
2M40DPL	1776603-1	202
2M40DPZ	2-1437684-5	202
2M40DPZL	1776639-1	202
2M40FC	2-1437684-6	201
2M40FCL	1776640-1	201
2M44PC	2-1437684-7	203,204
2M44PCF	1776641-1	203,204
2M50DSF	2-1437684-8	200
2M50DSM	2-1437684-9	200
2M50DSML	1776613-1	200
2M50FC	3-1437684-0	201
2M50FCL	1776642-1	201
2M50TELP	3-1437684-1	199
2M50TELP	1776643-1	199
2M50TELS	3-1437684-2	199
2M50TELSL	1776604-1	199
2M60FC	3-1437684-3	201
2M60FCL	1776644-1	201
2M64DIN	3-1437684-4	198
2M64DIN-C	3-1437684-5	198
2M64DIN-CL	1776646-1	198
2M64DIN-CL	1776645-1	196,198
2M64FC	3-1437684-6	201
2M64FCL	1776647-1	201
2PDT	—	207,210
2SV-02	1437671-1	104
2SV-03	1437671-4	104
2SV-04	1437671-6	104
2SV-05	1437671-7	104
2SV-06	1437671-9	104
2SV-07	1-1437671-0	104
2SV-08	1-1437671-1	104
2SV-09	1-1437671-2	104
2SV-10	1-1437671-3	104
2SV-11	1-1437671-4	104
2SV-12	1-1437671-5	104
2SV-13	1-1437671-6	104
2SV-14	1-1437671-9	104
2SV-15	2-1437671-0	104
2SV-16	2-1437671-1	104
2TK	—	206
2TK2	—	198,199,200,201,202,203,205,211
2TK2-10	1437685-3	211
2TK2-12	1437685-6	211
2TK2-15	1437685-7	211
2TK2-2	1437685-8	211
2TK2-24	1437685-9	211
2TK2-3	1-1437685-0	211
2TK2-48	1-1437685-3	211
2TK2-6	1-1437685-4	211
2TK2D	—	198,199,200,201,202,203,205,206,208,211

BUCHANAN Part Number	Tyco Part Number	Page Number
2TK2D-12	1-1437685-6	211
2TK2D-24	1-1437685-7	211
2TK2D-4	1-1437685-8	211
2TK2D-48	1-1437685-9	211
2TK2D-6	2-1437685-0	211
2TK-48	1437685-1	211
2TK-6	1437685-2	211
2TKD-12	1437814-1	211
2TKD-6	1437814-2	211
30-BU	3-1437381-9	253,262,270,275
311BR	1-1437683-2	206
311BRL	1776827-1	206
313BRL	1776619-1	205
314BS	1-1437683-3	208
314BSL	1776618-1	208
318BR	1-1437683-4	205
31-BU	2-1437397-1	287
330-BU	2-1437397-4	286
362-BU	3-1437397-3	286,294
368-BU	3-1437397-5	286
3B102P	4-1437381-0	290
3B104P	4-1437381-1	290
3B106P	4-1437381-3	290
3B108P	4-1437381-5	290
3B112P	4-1437381-7	290
3CF04	1437404-2	175
3CN02	1437418-3	175
3CN03	1437418-4	175
3CN06	1437418-5	175
3CN07	1437401-1	175
3CN10	7-1437418-0	175
3CN12	1437418-6	175
3LO1	1437402-2	166,169,178
3LO2	1437402-3	166,169,178
3PCV-03-006	—	120
3PCV-04-006	—	121
3PCV-10-006	—	120
3TK2-11	2-1437685-2	211
3TK2-12	2-1437685-3	211
3TK2-24	2-1437685-6	211
3TK2-4	2-1437685-9	211
3TK2-48	3-1437685-1	211
3TK2-5	3-1437685-3	211
3TK2-6	3-1437685-4	211
3TK2D-12	3-1437685-5	211
3TK2D-24	3-1437685-6	211
3TK2D-48	3-1437685-7	211
3TK2D-6	3-1437685-8	211
41-BU	2-1437393-3	270
426-BU	1437396-7	278,294
427-BU	1437396-8	278,295
42-BU	2-1437393-4	262
430-BU	1437396-9	278
44PC	3-1437684-7	203,204
44PCL	1776649-1	203,204
4B102P	5-1437381-6	290
4B104P	5-1437381-7	290
4B106P	5-1437381-8	290
4B108P	5-1437381-9	290
4B112P	6-1437381-0	290
4DBL-05-006	0-1546937-1	125
4DBL-06-006	0-1546937-2	125
4DBL-07-006	0-1546937-3	125
4DBL-08-006	0-1546937-4	125
4DBL-09-006	0-1546937-5	125
4DBL-10-006	0-1546937-6	125
4DBL-11-006	0-1546937-7	125
4DBL-13-006	0-1546937-8	125
4DBL-14-006	0-1546937-9	125
4DBL-15-006	1-1546937-0	125
4DBL-16-006	1-1546937-1	125
4DBL-17-006	1-1546937-2	125
4DBL-18-006	1-1546937-3	125
4DBL-19-006	1-1546937-4	125
4DBL-20-006	1-1546937-5	125
4DBL-21-006	1-1546937-6	125
4DBL-22-006	1-1546937-7	125
4DBL-23-006	1-1546937-8	125
4DBL-24-006	1-1546937-9	125
4DBL-25-006	2-1546937-0	125
4DBL-26-006	2-1546937-1	125
4DBL-27-006	2-1546937-2	125
4DBL-28-006	2-1546937-3	125
4DBL-29-006	2-1546937-4	125
4DBL-30-006	2-1546937-5	125
4DB-P107-02	1437667-6	143
4DB-P107-03	1437667-7	143
4DB-P107-04	1-1437667-0	143
4DB-P107-05	1-1437667-1	143
4DB-P107-06	1-1437667-2	143
4DB-P107-07	1-1437667-3	143
4DB-P107-08	1-1437667-4	143
4DB-P107-09	1-1437667-5	143
4DB-P107-10	1-1437667-6	143
4DB-P107-11	1-1437667-8	143

BUCHANAN Part Number	Tyco Part Number	Page Number
4DB-P107-12	1-1437667-9	143
4DB-P107-15	2-1437667-0	143
4DB-P107-16	2-1437667-1	143
4DB-P107-25	2-1437667-2	143
4DB-P107-26	2-1437667-3	143
4DB-P108-02	2-1437667-4	143
4DB-P108-03	2-1437667-5	143
4DB-P108-04	2-1437667-6	143
4DB-P108-05	2-1437667-8	143
4DB-P108-06	2-1437667-9	143
4DB-P108-07	3-1437667-0	143
4DB-P108-08	3-1437667-1	143
4DB-P108-09	3-1437667-2	143
4DB-P108-10	3-1437667-3	143
4DB-P108-11	3-1437667-5	143
4DB-P108-12	3-1437667-6	143
4DB-P108-13	3-1437667-7	143
4DB-P108-14	3-1437667-8	143
4DB-P108-15	3-1437667-9	143
4DB-P108-16	4-1437667-0	143
4DB-P108-17	4-1437667-2	143
4DB-P108-18	4-1437667-4	143
4DB-P108-19	4-1437667-5	143
4DB-P108-20	4-1437667-6	143
4DB-P108-21	796658-2	144
4DB-P108-22	4-1437667-8	143
4DB-P108-24	5-1437667-0	143
4DB-P108-26	5-1437667-2	143
4DB-P108-28	5-1437667-3	143
4DB-P108-30	5-1437667-5	143
4DB-P207-03	5-1437667-6	143
4DB-P207-04	5-1437667-7	143
4DB-P207-05	5-1437667-8	143
4DB-P207-06	5-1437667-9	143
4DB-P208-02	6-1437667-0	143
4DB-P208-04	6-1437667-1	143
4DB-P208-22	6-1437667-2	143
4DB-R107-02	6-1437667-3	143
4DB-R107-03	6-1437667-4	143
4DB-R107-04	6-1437667-5	143
4DB-R107-06	6-1437667-6	143
4DB-R107-07	6-1437667-7	143
4DB-R107-08	6-1437667-8	143
4DB-R107-11	7-1437667-0	143
4DB-R108-02	7-1437667-1	143
4DB-R108-03	7-1437667-2	143
4DB-R108-04	7-1437667-3	143
4DB-R108-05	7-1437667-4	143
4DB-R108-06	7-1437667-5	143
4DB-R108-15	7-1437667-7	143
4DB-R108-20	7-1437667-8	143
4DB-R108-23	1437668-7	143
4DB-R207-02	7-1437667-9	143
4DB-R207-05	8-1437667-0	143
4DB-R208-06	8-1437667-1	143
4DB-S208-02	8-1437667-3	143
4DB-S208-06	8-1437667-4	143
4DB-S208-12	8-1437667-5	143
4DB-W108-06	8-1437667-6	143
4DB-W108-12	8-1437667-7	143
4DB-W108-18	8-1437667-8	143
4DB-W108-20	8-1437667-9	143
4DB-W207-02	9-1437667-0	143
4DB-W207-03	9-1437667-1	143
4DB-W207-04	9-1437667-2	143
4DB-W208-02	9-1437667-3	143
4DB-W208-03	9-1437667-4	143
4DB-W208-04	9-1437667-5	143
4DB-W208-09	9-1437667-7	143
4DB-W208-14	9-1437667-8	143
4PCR-02-008	0-1546940-1	125
4PCR-03-008	0-1546940-2	125
4PCR-05-008	0-1546940-3	125
4PCR-06-008	0-1546940-4	125
4PCR-06-517	0-1546283-2	125
4PCR-06-519	0-1546283-1	125
4PCR-07-008	0-1546940-5	125
4PCR-08-008	0-1546940-6	125
4PCR-09-008	0-1546940-7	125
4PCR-09-518	0-1546283-3	125
4PCR-10-008	0-1546940-8	125
4PCR-11-006	0-1546283-4	125
4PCR-11-008	0-1546940-9	125
4PCR-12-008	1-1546940-0	125
4PCR-13-006	0-1546283-5	125
4PCR-13-008	1-1546940-1	125
4PCR-14-006	0-1546283-6	125
4PCR-14-008	1-1546940-2	125
4PCR-15-006	0-1546283-7	125
4PCR-15-008	1-1546940-3	125
4PCR-16-006	0-1546283-8	125
4PCR-16-008	1-1546940-4	125
4PCR-17-008	1-1546940-5	125

Note: All part numbers are RoHS Compliant.

BUCHANAN Part Number	Tyco Part Number	Page Number
4PCR-18-006	0-1546283-9	125
4PCR-18-008	1-1546940-6	125
4PCR-19-006	1-1546283-0	125
4PCR-19-008	1-1546940-7	125
4PCR-20-006	1-1546283-1	125
4PCR-20-008	1-1546940-8	125
4PCR-21-006	1-1546283-2	125
4PCR-21-008	1-1546940-9	125
4PCR-22-006	1-1546283-3	125
4PCR-22-008	2-1546940-0	125
4PCR-23-008	2-1546940-1	125
4PCR-24-008	2-1546940-2	125
4PCR-25-006	1-1546283-4	125
4PCR-25-008	2-1546940-3	125
4PCR-26-006	1-1546283-5	125
4PCR-26-008	2-1546940-4	125
4PCR-27-006	1-1546283-6	125
4PCR-27-008	2-1546940-5	125
4PCR-28-008	2-1546940-6	125
4PCR-29-006	1-1546283-7	125
4PCR-30-006	1-1546283-8	125
4PCV-02-511	0-0796607-7	125
4PCV-02-514	1-0796607-0	125
4PCV-03-515	1-0796607-1	125
4PCV-03-521	1-0796607-7	125
4PCV-04-006	6-1437648-7	125
4PCV-04-007	0-1776097-4	125
4PCV-04-512	0-0796607-8	125
4PCV-04-522	1-0796607-8	125
4PCV-05-520	1-0796607-6	125
4PCV-06-006	8-1437648-0	125
4PCV-06-513	0-0796607-9	125
4PCV-06-523	1-0796607-9	125
4PCV-07-524	2-0796607-0	125
4PCV-08-235	9-1546119-9	125
4PCV-12-008	0-1546939-1	125
4PCV-13-008	0-1546939-2	125
4PCV-14-008	0-1546939-3	125
4PCV-16-008	0-1546939-4	125
4PCV-17-008	0-1546939-5	125
4PCV-18-008	0-1546939-6	125
4PCV-19-008	0-1546939-7	125
4PCV-20-008	0-1546939-8	125
4PCV-21-006	1-0796607-2	125
4PCV-21-008	0-1546939-9	125
4PCV-22-008	1-1546939-0	125
4PCV-23-008	1-1546939-1	125
4PCV-24-008	1-1546939-2	125
4PCV-25-008	1-1546939-3	125
4PCV-26-006	1-0796607-3	125
4PCV-26-008	1-1546939-4	125
4PCV-27-008	1-1546939-5	125
4PCV-28-006	1-0796607-4	125
4PCV-28-008	1-1546939-6	125
4PCV-29-006	1-0796607-5	125
4WWW-02-006	0-0796598-7	125
4WWW-02-008	2-0796598-9	125
4WWW-04-006	0-0796598-8	125
4WWW-05-006	0-0796598-9	125
4WWW-06-006	1-0796598-0	125
4WWW-07-006	1-0796598-1	125
4WWW-07-008	3-0796598-0	125
4WWW-09-006	1-0796598-2	125
4WWW-09-008	3-0796598-1	125
4WWW-10-004	3-0796988-6	125
4WWW-10-006	1-0796598-3	125
4WWW-11-008	3-0796598-2	125
4WWW-12-006	1-0796988-5	125
4WWW-12-008	3-0796598-3	125
4WWW-13-006	1-0796598-4	125
4WWW-13-008	3-0796598-4	125
4WWW-14-006	1-0796598-5	125
4WWW-15-006	1-0796598-6	125
4WWW-15-008	3-0796598-5	125
4WWW-16-006	1-0796598-7	125
4WWW-17-006	1-0796598-8	125
4WWW-17-008	3-0796598-6	125
4WWW-18-006	1-0796598-9	125
4WWW-18-008	3-0796598-7	125
4WWW-19-006	2-0796598-0	125
4WWW-19-008	3-0796598-8	125
4WWW-20-008	3-0796598-9	125
4WWW-21-006	2-0796598-1	125
4WWW-21-008	4-0796598-0	125
4WWW-22-006	2-0796598-2	125
4WWW-22-008	4-0796598-1	125
4WWW-23-006	2-0796598-3	125
4WWW-23-008	4-0796598-2	125
4WWW-24-006	2-0796598-4	125
4WWW-24-008	0-0796598-6	125
4WWW-25-006	2-0796598-5	125
4WWW-25-008	4-0796598-3	125
4WWW-26-006	2-0796598-6	125
4WWW-26-008	4-0796598-4	125
4WWW-27-006	2-0796598-7	125

BUCHANAN Part Number	Tyco Part Number	Page Number
4WWW-27-008	4-0796598-5	125
4WWW-28-006	2-0796598-8	125
4WWW-28-008	4-0796598-6	125
4WWW-29-008	4-0796598-7	125
4WWW-30-008	4-0796598-8	125
5003ZEL	1546182-1	236
5003ZELRZ	1546182-2	236
500BZM	—	237
500SI	—	214
500SI10	—	234
500SI10K	—	234
500SI5	—	234
500SI5K	—	234
503SI	—	214
503SI1	1776301-1	225
503SI1DS	1776301-6	225
503SI2	1776301-2	216,225
503SI2DS	1776301-7	225
503SI3	1776301-3	225
503SI3DS	1776301-8	225
503SI3E	1-1776301-3	225
503SI3EDS	2-1776301-3	225
503SI4	1776301-4	225
503SI4DS	1776301-9	225
503SI4E	1-1776301-4	225
503SI4EDS	—	225
503SI5	1776301-5	225
503SI5DS	1-1776301-0	225
503SI5E	1-1776301-5	225
503SI5EDS	—	225
51-BU	7-1437381-7	291
53-BU	7-1437381-8	275,279
55-BU	8-1437381-0	254,262,270,275,279,284,287
5B102	8-1437381-4	290
5B104	8-1437381-5	290
5B106	8-1437381-7	290
5B108	8-1437381-8	290
5B112	9-1437381-0	290
5ESDV	—	77
5KEV	—	12
5LEA	—	26
5LEEV	—	32
608BR	1-1437683-6	205
608BRL	1776620-1	205
608BS	1-1437683-7	209
608BSL	1776621-1	209
60836	9-1437381-2	246,253,262,270,275,279,284,287
60-BU	9-1437381-1	287
611BR	1-1437683-8	206
611BRL	1776622-1	206
611BS	1-1437683-9	209
611BSL	1776623-1	209
614BS	2-1437683-0	208
614BSL	1776637-1	208
61500511A	—	293
63-BU	9-1437381-8	246,253,262,270,275,279,284,287
65-BU	4-1437393-0	254,262,270
6DBL-02-1307	2-1546158-2	129
6DBL-05-007	0-1546821-5	129
6DBL-06-007	0-1546821-6	129
6DBL-07-007	0-1546821-7	129
6DBL-07-1372	4-1546159-0	129
6DBL-08-006	0-1546685-1	129
6DBL-08-007	0-1546821-8	129
6DBL-09-006	0-1546685-2	129
6DBL-09-007	0-1546821-9	129
6DBL-10-006	0-1546685-3	129
6DBL-10-007	1-1546821-0	129
6DBL-11-006	0-1546685-4	129
6DBL-11-007	1-1546821-1	129
6DBL-12-007	1-1546821-2	129
6DBL-13-006	0-1546685-5	129
6DBL-13-007	1-1546821-3	129
6DBL-14-006	0-1546685-6	129
6DBL-14-007	1-1546821-4	129
6DBL-15-006	0-1546685-7	129
6DBL-15-007	1-1546821-5	129
6DBL-16-006	0-1546685-8	129
6DBL-16-007	1-1546821-6	129
6DBL-17-006	0-1546685-9	129
6DBL-17-007	1-1546821-7	129
6DBL-18-006	1-1546685-0	129
6DBL-18-007	1-1546821-8	129
6DBL-19-006	1-1546685-1	129
6DBL-19-007	1-1546821-9	129
6DBL-20-006	1-1546685-2	129
6DBL-20-007	2-1546821-0	129
6DBL-21-006	1-1546685-3	129
6DBL-21-007	2-1546821-1	129
6DBL-22-006	1-1546685-4	129
6DBL-22-007	2-1546821-2	129
6DBL-23-006	1-1546685-5	129

BUCHANAN Part Number	Tyco Part Number	Page Number
6DBL-23-007	2-1546821-3	129
6DBL-24-006	1-1546685-6	129
6DBL-24-007	2-1546821-4	129
6DBL-25-006	1-1546685-7	129
6DBL-25-007	2-1546821-5	129
6DBL-26-006	1-1546685-8	129
6DBL-26-007	2-1546821-6	129
6DBL-27-006	1-1546685-9	129
6DBL-27-007	2-1546821-7	129
6DBL-28-006	2-1546685-0	129
6DBL-28-007	2-1546821-8	129
6DBL-29-006	2-1546685-1	129
6DBL-29-007	2-1546821-9	129
6DBL-30-006	2-1546685-2	129
6DBL-30-007	3-1546821-0	129
6PCR-05-007	1-1546399-4	129
6PCR-06-008	3-1546158-2	129
6PCR-07-008	3-1546399-3	129
6PCR-08-1383	0-0796905-1	129
6PCR-09-007	1-1546399-5	129
6PCR-09-008	3-1546399-4	129
6PCR-10-007	1-1546399-6	129
6PCR-11-007	1-1546399-7	129
6PCR-11-008	3-1546399-5	129
6PCR-12-008	3-1546399-6	129
6PCR-12-1381	2-0796988-3	129
6PCR-12-1382	2-0796988-9	129
6PCR-13-006	0-1546399-2	129
6PCR-13-007	1-1546399-8	129
6PCR-13-008	3-1546399-7	129
6PCR-14-007	1-1546399-9	129
6PCR-14-008	3-1546399-8	129
6PCR-15-006	0-1546399-3	129
6PCR-15-007	2-1546399-0	129
6PCR-15-008	3-1546399-9	129
6PCR-16-006	0-1546399-4	129
6PCR-16-007	2-1546399-1	129
6PCR-16-008	4-1546399-0	129
6PCR-17-006	0-1546399-5	129
6PCR-17-007	2-1546399-2	129
6PCR-17-008	4-1546399-1	129
6PCR-18-007	2-1546399-3	129
6PCR-18-008	4-1546399-2	129
6PCR-19-006	0-1546399-6	129
6PCR-19-007	2-1546399-4	129
6PCR-19-008	4-1546399-3	129
6PCR-19-1139	4-1546158-1	129
6PCR-20-006	0-0796988-4	129
6PCR-20-007	2-1546399-5	129
6PCR-20-008	4-1546399-4	129
6PCR-21-006	0-1546399-7	129
6PCR-21-007	2-1546399-6	129
6PCR-21-008	4-1546399-5	129
6PCR-22-006	0-1546399-8	129
6PCR-22-007	2-1546399-7	129
6PCR-22-008	4-1546399-6	129
6PCR-23-006	0-1546399-9	129
6PCR-23-007	2-1546399-8	129
6PCR-23-008	4-1546399-7	129
6PCR-24-007	2-1546399-9	129
6PCR-24-008	4-1546399-8	129
6PCR-25-006	1-1546399-0	129
6PCR-25-007	3-1546399-0	129
6PCR-25-008	4-1546399-9	129
6PCR-26-006	1-1546399-1	129
6PCR-26-007	3-1546399-1	129
6PCR-26-008	5-1546399-0	129
6PCR-27-006	1-1546399-2	129
6PCR-27-007	3-1546399-2	129
6PCR-27-008	5-1546399-1	129
6PCR-28-006	1-1546399-3	129
6PCR-28-008	5-1546399-2	129
6PCR-29-006	0-1546817-2	129
6PCR-29-007	0-0796905-2	129
6PCR-30-006	0-1546817-2	129
6PCR-30-007	0-0796905-3	129
6PCV-02-009	2-1546686-2	129
6PCV-02-1210	4-1546158-3	129
6PCV-02-1216	4-1546158-4	129
6PCV-02-1286	0-1546045-2	129
6PCV-03-006	5-1437652-4	129
6PCV-03-1256	4-1546158-7	129
6PCV-03-1287	0-1546045-3	129
6PCV-03-1384	4-1546686-6	129
6PCV-03-1385	4-1546686-7	129
6PCV-03-923	4-1546158-8	129
6PCV-04-006	6-1437652-7	129
6PCV-04-1288	5-1546158-0	129
6PCV-04-1288	0-1546045-4	129
6PCV-05-1267	5-1546158-3	129
6PCV-05-1289	0-1546045-5	129
6PCV-06-006	9-1437652-5	129
6PCV-06-008	1-0796988-2	129
6PCV-06-1290	0-1546045-6	129
6PCV-07-1291	0-1546045-7	129

Note: All part numbers are RoHS Compliant.

BUCHANAN Part Number	Tyco Part Number	Page Number
6PCV-08-009	2-1546686-3	129
6PCV-08-1292	0-1546045-8	129
6PCV-09-009	2-1546686-4	129
6PCV-09-1293	0-1546045-9	129
6PCV-10-003	6-1546158-1	129
6PCV-10-008	0-1546686-1	129
6PCV-10-009	2-1546686-5	129
6PCV-10-1269	6-1546158-2	129
6PCV-10-1294	1-1546045-0	129
6PCV-11-007	1-1546686-3	129
6PCV-11-009	2-1546686-6	129
6PCV-11-1295	1-1546045-1	129
6PCV-11-6176	0-0796907-1	129
6PCV-12-1296	1-1546160-6	129
6PCV-13-009	2-1546686-7	129
6PCV-13-1297	1-1546160-7	129
6PCV-14-008	0-1546686-2	129
6PCV-14-009	2-1546686-8	129
6PCV-15-009	2-1546686-9	129
6PCV-15-1298	1-1546160-8	129
6PCV-16-009	3-1546686-0	129
6PCV-16-1388	4-1546686-8	129
6PCV-16-1389	4-1546686-9	129
6PCV-17-007	1-1546686-4	129
6PCV-17-008	0-1546686-3	129
6PCV-17-009	3-1546686-1	129
6PCV-18-009	3-1546686-2	129
6PCV-18-1390	0-1546262-5	129
6PCV-19-007	1-1546686-5	129
6PCV-19-008	0-1546686-4	129
6PCV-19-009	3-1546686-3	129
6PCV-20-009	3-1546686-4	129
6PCV-20-1359	7-1546158-6	129
6PCV-20-1360	7-1546158-7	129
6PCV-20-1361	7-1546158-8	129
6PCV-20-1362	7-1546158-9	129
6PCV-20-323	8-1546158-0	129
6PCV-21-007	1-1546686-6	129
6PCV-21-008	0-1546686-5	129
6PCV-21-009	3-1546686-5	129
6PCV-22-007	1-1546686-7	129
6PCV-22-008	0-1546686-6	129
6PCV-22-009	3-1546686-6	129
6PCV-23-006	4-1546686-3	129
6PCV-23-007	1-1546686-8	129
6PCV-23-008	0-1546686-7	129
6PCV-23-009	3-1546686-7	129
6PCV-24-008	0-1546686-8	129
6PCV-24-009	3-1546686-8	129
6PCV-25-007	1-1546686-9	129
6PCV-25-008	0-1546686-9	129
6PCV-25-009	3-1546686-9	129
6PCV-26-008	1-1546686-0	129
6PCV-26-009	4-1546686-0	129
6PCV-27-007	2-1546686-0	129
6PCV-27-008	1-1546686-1	129
6PCV-27-009	4-1546686-1	129
6PCV-28-007	2-1546686-1	129
6PCV-28-008	1-1546686-2	129
6PCV-29-009	4-1546686-2	129
6PCV-29-006	4-1546686-4	129
6PCV-29-007	0-1546814-1	129
6PCV-30-006	4-1546686-5	129
6STR-02-007	2-1546174-2	129
6STR-02-009	0-1776037-2	129
6STR-03-007	2-1546174-3	129
6STR-03-009	0-1776037-3	129
6STR-04-006	0-0796988-8	129
6STR-04-007	2-1546174-4	129
6STR-04-008	0-1546242-4	129
6STR-04-009	0-1776037-4	129
6STR-04-263	9-1546158-1	129
6STR-04-392	9-1546158-2	129
6STR-05-007	2-1546174-5	129
6STR-05-009	0-1776037-5	129
6STR-06-007	2-1546174-6	129
6STR-06-009	0-1776037-6	129
6STR-07-007	2-1546174-7	129
6STR-07-008	0-0796988-7	129
6STR-07-009	0-1776037-7	129
6STR-07-1228	9-1546158-6	129
6STR-08-007	2-1546174-8	129
6STR-08-009	0-1776037-8	129
6STR-09-006	0-1546174-2	129
6STR-09-007	2-1546174-9	129
6STR-09-009	0-1776037-9	129
6STR-10-006	0-1546174-3	129
6STR-10-009	1-1776037-0	129
6STR-11-006	0-1546174-4	129
6STR-11-007	3-1546174-0	129
6STR-11-008	1-1546242-1	129
6STR-11-009	1-1776037-1	129
6STR-12-006	0-1546174-5	129
6STR-12-007	3-1546174-1	129
6STR-12-009	1-1776037-2	129

BUCHANAN Part Number	Tyco Part Number	Page Number
6STR-13-007	3-1546174-2	129
6STR-13-009	1-1776037-3	129
6STR-14-006	0-1546174-6	129
6STR-14-007	3-1546174-3	129
6STR-14-009	1-1776037-4	129
6STR-15-006	0-1546174-7	129
6STR-15-007	3-1546174-4	129
6STR-15-009	1-1776037-5	129
6STR-16-006	0-1546174-8	129
6STR-16-007	3-1546174-5	129
6STR-16-009	1-1776037-6	129
6STR-17-006	0-1546174-9	129
6STR-17-007	3-1546174-6	129
6STR-17-009	1-1776037-7	129
6STR-18-006	1-1546174-0	129
6STR-18-007	3-1546174-7	129
6STR-18-009	1-1776037-8	129
6STR-19-006	1-1546174-1	129
6STR-19-007	3-1546174-8	129
6STR-19-009	1-1776037-9	129
6STR-20-006	1-1546174-2	129
6STR-20-007	3-1546174-9	129
6STR-20-009	2-1776037-0	129
6STR-21-006	1-1546174-3	129
6STR-21-007	4-1546174-0	129
6STR-21-009	2-1776037-1	129
6STR-22-006	1-1546174-4	129
6STR-22-007	4-1546174-1	129
6STR-22-009	2-1776037-2	129
6STR-23-006	1-1546174-5	129
6STR-23-007	4-1546174-2	129
6STR-23-009	2-1776037-3	129
6STR-24-006	1-1546174-6	129
6STR-24-007	4-1546174-3	129
6STR-24-009	2-1776037-4	129
6STR-25-006	1-1546174-7	129
6STR-25-007	4-1546174-4	129
6STR-25-009	2-1776037-5	129
6STR-26-006	1-1546174-8	129
6STR-26-007	4-1546174-5	129
6STR-26-009	2-1776037-6	129
6STR-27-006	1-1546174-9	129
6STR-27-007	4-1546174-6	129
6STR-27-009	2-1776037-7	129
6STR-28-006	2-1546174-0	129
6STR-28-007	4-1546174-7	129
6STR-28-009	2-1776037-8	129
6STR-29-006	0-1546816-1	129
6STR-30-006	0-1546816-2	129
6STV-02-007	0-1776325-2	129
6STV-02-008	0-1546820-2	129
6STV-03-007	0-1776325-3	129
6STV-04-007	0-1776325-4	129
6STV-04-008	0-1546277-1	129
6STV-04-1068	0-1546159-3	129
6STV-05-008	0-1546820-5	129
6STV-05-1059	0-1546159-6	129
6STV-06-006	1-0796988-0	129
6STV-06-007	0-1776325-6	129
6STV-06-727	0-0796989-1	129
6STV-07-007	0-1776325-7	129
6STV-07-008	0-1546820-7	129
6STV-08-007	0-1776325-8	129
6STV-08-008	0-1546820-8	129
6STV-09-006	0-1546277-2	129
6STV-09-007	0-1776325-9	129
6STV-09-008	0-1546820-9	129
6STV-10-007	1-1776325-0	129
6STV-10-008	1-1546820-0	129
6STV-11-006	0-1546277-3	129
6STV-11-007	1-1776325-1	129
6STV-11-008	1-1546820-1	129
6STV-12-007	1-1776325-2	129
6STV-12-008	1-1546820-2	129
6STV-13-006	0-1546277-4	129
6STV-13-007	1-1776325-3	129
6STV-13-008	1-1546820-3	129
6STV-14-006	0-1546277-5	129
6STV-14-007	1-1776325-4	129
6STV-14-008	1-1546820-4	129
6STV-15-007	1-1776325-5	129
6STV-15-008	1-1546820-5	129
6STV-16-006	0-1546277-6	129
6STV-16-007	1-1776325-6	129
6STV-16-008	1-1546820-6	129
6STV-17-006	0-1546277-7	129
6STV-17-007	1-1776325-7	129
6STV-17-008	1-1546820-7	129
6STV-18-006	0-1546277-8	129
6STV-18-007	1-1776325-8	129
6STV-18-008	1-1546820-8	129
6STV-19-006	0-1546277-9	129
6STV-19-007	1-1776325-9	129
6STV-19-008	1-1546820-9	129
6STV-20-006	1-1546277-0	129

BUCHANAN Part Number	Tyco Part Number	Page Number
6STV-20-007	2-1776325-0	129
6STV-21-006	1-1546277-1	129
6STV-21-007	2-1776325-1	129
6STV-21-008	2-1546820-1	129
6STV-21-404	2-1776325-9	129
6STV-22-006	1-1546277-2	129
6STV-22-007	2-1776325-2	129
6STV-22-008	2-1546820-2	129
6STV-23-006	1-1546277-3	129
6STV-23-007	2-1776325-3	129
6STV-23-008	2-1546820-3	129
6STV-24-006	1-1546277-4	129
6STV-24-007	2-1776325-4	129
6STV-24-008	2-1546820-4	129
6STV-25-006	1-1546277-5	129
6STV-25-007	2-1776325-5	129
6STV-25-008	2-1546820-5	129
6STV-26-006	1-1546277-6	129
6STV-26-007	2-1776325-6	129
6STV-26-008	2-1546820-6	129
6STV-27-006	1-1546277-7	129
6STV-27-007	2-1776325-7	129
6STV-27-008	2-1546820-7	129
6STV-28-006	1-1546277-8	129
6STV-28-007	2-1776325-8	129
6STV-28-008	2-1546820-8	129
6STV-29-008	2-1546820-9	129
6STV-30-008	3-1546820-0	129
6TBV-02-006	0-1546692-1	129
6TBV-03-006	0-1546692-2	129
6TBV-05-006	0-1546692-3	129
6TBV-07-006	0-1546692-4	129
6TBV-11-006	0-1546692-5	129
6TBV-12-006	0-1546692-6	129
6TBV-13-006	0-1546692-7	129
6TBV-14-006	0-1546692-8	129
6TBV-15-006	0-1546692-9	129
6TBV-16-006	1-1546692-0	129
6TBV-17-006	1-1546692-1	129
6TBV-18-006	1-1546692-2	129
6TBV-19-006	1-1546692-3	129
6TBV-20-006	1-1546692-4	129
6TBV-21-006	1-1546692-5	129
6TBV-22-006	1-1546692-6	129
6TBV-23-006	1-1546692-7	129
6TBV-24-006	1-1546692-8	129
6TBV-25-006	1-1546692-9	129
6TBV-26-006	2-1546692-0	129
6TBV-27-006	2-1546692-1	129
6TBV-28-006	2-1546692-2	129
6TK2	—	211
6TK2-12	4-1437685-6	211
6TK2-14	4-1437685-7	211
6TK2-2	4-1437685-8	211
6TK2-4	4-1437685-9	211
6TK2-48	5-1437685-0	211
6TK2-5	5-1437685-2	211
6TK2-6	5-1437685-5	211
6TK2D	—	211
6TK2D-12	5-1437685-6	211
6TK2D-48	5-1437685-7	211
6TK2D-6	5-1437685-8	211
6WWW-02-008	2-0796612-7	129
6WWW-03-008	2-0796612-8	129
6WWW-03-693	1-1546159-6	129
6WWW-04-008	2-0796612-9	129
6WWW-06-008	0-0796612-2	129
6WWW-07-006	0-0796612-7	129
6WWW-07-008	3-0796612-0	129
6WWW-08-008	3-0796612-1	129
6WWW-10-006	0-0796612-8	129
6WWW-10-008	3-0796612-2	129
6WWW-11-006	0-0796612-9	129
6WWW-11-008	3-0796612-3	129
6WWW-12-006	1-0796612-0	129
6WWW-12-008	3-0796612-4	129
6WWW-13-006	1-0796612-1	129
6WWW-13-008	3-0796612-5	129
6WWW-14-006	1-0796612-2	129
6WWW-14-984	2-1546159-0	129
6WWW-15-006	1-0796612-3	129
6WWW-15-008	3-0796612-6	129
6WWW-16-006	1-0796612-4	129
6WWW-16-008	3-0796612-7	129
6WWW-17-006	1-0796612-5	129
6WWW-17-008	3-0796612-8	129</

Note: All part numbers are RoHS Compliant.

BUCHANAN Part Number	Tyco Part Number	Page Number
6WWR-22-008	4-0796612-3	129
6WWR-23-006	2-0796612-1	129
6WWR-23-008	4-0796612-4	129
6WWR-23-1096	2-1546159-1	129
6WWR-24-006	2-0796612-2	129
6WWR-24-008	4-0796612-5	129
6WWR-25-006	2-0796612-3	129
6WWR-25-008	4-0796612-6	129
6WWR-26-006	2-0796612-4	129
6WWR-26-008	4-0796612-7	129
6WWR-27-006	2-0796612-5	129
6WWR-27-008	4-0796612-9	129
6WWR-28-006	2-0796612-6	129
6WWR-28-008	4-0796612-9	129
6WWR-29-006	0-1546815-1	129
6WWR-30-006	0-1546815-2	129
6WVV-02-006	0-0796608-2	129
6WVV-05-008	2-0796608-0	129
6WVV-07-006	0-0796608-3	129
6WVV-09-006	0-0796608-4	129
6WVV-09-008	2-0796608-1	129
6WVV-11-006	0-0796608-5	129
6WVV-12-006	3-1546159-2	129
6WVV-13-006	0-0796608-6	129
6WVV-13-008	2-0796608-2	129
6WVV-14-006	0-0796608-7	129
6WVV-15-006	0-0796608-8	129
6WVV-15-008	2-0796608-3	129
6WVV-16-006	0-0796608-9	129
6WVV-16-008	2-0796608-4	129
6WVV-17-006	1-0796608-0	129
6WVV-18-006	1-0796608-1	129
6WVV-18-008	2-0796608-5	129
6WVV-19-006	1-0796608-2	129
6WVV-19-008	2-0796608-6	129
6WVV-20-1019	3-1546159-7	129
6WVV-21-006	1-0796608-3	129
6WVV-21-008	2-0796608-7	129
6WVV-22-008	2-0796608-8	129
6WVV-23-006	1-0796608-4	129
6WVV-23-008	2-0796608-9	129
6WVV-24-006	1-0796608-5	129
6WVV-25-006	1-0796608-6	129
6WVV-25-008	3-0796608-0	129
6WVV-26-006	1-0796608-7	129
6WVV-26-008	3-0796608-1	129
6WVV-27-006	1-0796608-8	129
6WVV-27-008	3-0796608-2	129
6WVV-28-006	1-0796608-9	129
6WVV-28-008	3-0796608-3	129
6WVV-29-008	3-0796608-4	129
6WVV-30-008	3-0796608-5	129
78-TB	1-1437382-7	254
7B102	1-1437382-8	290
7B102N	1-1437382-9	290
7B104	2-1437382-0	290
7B106	2-1437382-1	290
7B106H	796756-6	290
7B108	2-1437382-2	290
7B112	2-1437382-3	290
7B112T	2-1437382-4	290
7C1F13	3-1437418-7	153
7C1F16	3-1437418-8	153
7C1N02	3-1437418-9	153
7C1N03	4-1437418-0	153
7C1N04	4-1437418-1	153
7C1N05	4-1437418-2	153
7C1N06	4-1437418-3	153
7C1N07	4-1437418-4	153
7C1N08	4-1437418-5	153
7C1N09	4-1437418-6	153
7C1N10	4-1437418-7	153
7C1N12	4-1437418-8	153
7C1N13	1437412-5	153
7C1N16	4-1437418-9	153
7C1N19	5-1437418-0	153
7C1N25	1437412-6	153
7C1N48	5-1437418-1	153
824-BU	1437395-3	274,295
830-BU	1-1437395-4	274
8PCV-04-006	8-1437657-0	137
8R-SOCKET	2-1437683-1	210
8S-SOCKET	2-1437683-2	210
93-BU	4-1437390-4	275
ABK40502	—	235
ABK40503	—	235
ABK40504	—	235
ABK40506	—	235
ABK40512	—	235
ABK40602	—	235
ABK40603	—	235
ABK40604	—	235
ABK40606	—	235
ABK40612	—	235
ABK41502	—	235

BUCHANAN Part Number	Tyco Part Number	Page Number
ABK41503	—	235
ABK41504	—	235
ABK41506	—	235
ABK50302	—	235
ABK50303	—	235
ABK50304	—	235
ABK50305	—	235
ABK50312	—	235
B024C4H	—	21
B02C4V	—	12
B03C5V	—	17
B04C4V	—	26
B07C4V	—	32
B102	2-1437382-6	290,295
B102C	2-1437382-7	290
B102S	2-1437382-8	290,295
B102SN	2-1437382-9	290
B104	3-1437382-0	290
B104C	3-1437382-1	290
B104CH	3-1437382-2	290
B104CHN	3-1437382-3	290
B104H	3-1437382-4	290
B104N	3-1437382-5	290
B104S	3-1437382-6	290
B104SH	3-1437382-7	290
B104SN	3-1437382-8	290
B106-BU	4-1437382-0	290
B106C	4-1437382-1	290
B106C-N	4-1437382-2	290
B106H	4-1437382-3	290
B106N	4-1437382-4	290
B106S	4-1437382-5	290
B106SN	4-1437382-6	290
B106T	4-1437382-8	290
B108	4-1437382-9	290
B108C	5-1437382-0	290
B108CN	5-1437382-1	290
B108H	5-1437382-2	290
B108HN	5-1437382-3	290
B108N	5-1437382-4	290
B108S	5-1437382-5	290
B108SN	5-1437382-6	290
B108T	5-1437382-8	290
B112-BU	5-1437382-9	290,295
B112C	6-1437382-0	290
B112CH	6-1437382-1	290
B112CN	6-1437382-2	290
B112CT	6-1437382-3	290
B112H	6-1437382-4	290
B112HN	6-1437382-5	290
B112N	6-1437382-6	290
B112S	6-1437382-7	290
B112S	6-1437382-7	295
B112SH	6-1437382-8	290
B112T	7-1437382-0	290
B2EHDV	—	52
B51C4	—	290
B51C4U02T	1437426-1	89
B51C4U03T	1437426-3	89
B51C4U04T	1437426-9	89
B51C4U05T	1-1437426-3	89
B51C4U06T	1-1437426-6	89
B51C4U07T	2-1437426-0	89
B51C4U08T	2-1437426-5	89
B51C4U09T	2-1437426-8	89
B51C4U10T	3-1437426-2	89
B51C4U11T	3-1437426-6	89
B51C4U12T	3-1437426-9	89
B51C4U13T	4-1437426-6	89
B51C4U14T	4-1437426-9	89
B51C4U15T	5-1437426-1	89
B51C4U16T	5-1437426-3	89
B51C4U17T	—	89
B51C4U18T	5-1437426-6	89
B51C4U19T	—	89
B51C4U20T	5-1437426-7	89
B51C4U21T	—	89
B51C4U22T	5-1437426-8	89
B51C4U23T	—	89
B51C4U24T	5-1437426-9	89
B51C8	—	91
B51C8U02T	7-1437426-1	91
B51C8U03T	7-1437426-2	91
B51C8U04T	7-1437426-4	91
B51C8U05T	7-1437426-5	91
B51C8U06T	7-1437426-7	91
B51C8U07T	7-1437426-8	91
B51C8U08T	8-1437426-0	91
B51C8U09T	8-1437426-1	91
B51C8U10T	8-1437426-3	91
B51C8U11T	8-1437426-6	91
B51C8U12T	8-1437426-7	91
B51C8U13T	9-1437426-0	91
B51C8U14T	9-1437426-1	91
B51C8U15T	9-1437426-2	91

BUCHANAN Part Number	Tyco Part Number	Page Number
B52C3U	—	76
B52C4U	—	77
B71N4	—	89
B71N4V02T	1776452-2	90
B71N4V03T	1776452-3	90
B71N4V04T	1776452-4	90
B71N4V05T	1776452-5	90
B71N4V06T	1776452-6	90
B71N4V07T	1776452-7	90
B71N4V08T	1776452-8	90
B71N4V09T	1776452-9	90
B71N4V10T	1-1776452-0	90
B71N4V11T	1-1776452-1	90
B71N4V12T	1-1776452-2	90
B71N4V13T	1-1776452-3	90
B71N4V14T	1-1776452-4	90
B71N4V15T	1-1776452-5	90
B71N4V16T	1-1776452-6	90
B71N4V17T	1-1776452-7	90
B71N4V18T	1-1776452-8	90
B71N4V19T	—	90
B71N4V20T	2-1776452-0	90
B71N4V21T	—	90
B71N4V22T	2-1776452-2	90
B71N4V23T	—	90
B71N4V24T	2-1776452-4	90
B71N8V02T	1776453-2	92
B71N8V03T	1776453-3	92
B71N8V04T	1776453-4	92
B71N8V05T	1776453-5	92
B71N8V06T	1776453-6	92
B71N8V07T	1776453-7	92
B71N8V08T	1776453-8	92
B71N8V09T	1776453-9	92
B71N8V10T	1-1776453-0	92
B71N8V11T	1-1776453-1	92
B71N8V12T	1-1776453-2	92
B71N8V13T	—	92
B71N8V14T	1-1776453-4	92
B71N8V15T	—	92
B71N8V16T	1-1776453-6	92
B71N8V17T	1-1776453-7	92
B71N8V18T	1-1776453-8	92
B71N8V19T	—	92
B71N8V20T	2-1776453-0	92
B71N8V21T	—	92
B71N8V22T	2-1776453-2	92
B71N8V23T	—	92
B71N8V24T	2-1776453-4	92
B72N4H	—	59
B72N4V	—	51
B73N3H	—	58
B73N3V	—	49
B73N4H	—	60
B73N4V	—	51
BC6	—	174,177,178
BC6-P107-02	0-1546866-2	134
BC6-P107-03	0-1546866-3	134
BC6-P107-03-287	2-1546866-1	134
BC6-P107-03-288	2-1546866-2	134
BC6-P107-05	0-1546866-5	134
BC6-P107-06	0-1546866-6	134
BC6-P107-07	0-1546866-7	134
BC6-P107-09	0-1546866-9	134
BC6-P107-10	1-1546866-0	134
BC6-P107-11	1-1546866-1	134
BC6-P107-12	1-1546866-2	134
BC6-P107-13	1-1546866-3	134
BC6-P107-14	1-1546866-4	134
BC6-P107-15	1-1546866-5	134
BC6-P107-16	1-1546866-6	134
BC6-P107-17	1-1546866-7	134
BC6-P107-18	1-1546866-8	134
BC6-P107-19	1-1546866-9	134
BC6-P107-20	2-1546866-0	134
BC6-P108-03-289	0-0796595-2	134
BC6-P108-03-290	0-0796595-3	134
BC6-P108-06-284	0-0796595-1	134
BC6-P108-08	1-1437662-2	134
BC6-P108-16-291	0-0796595-4	134
BC6-P108-18	7-1437662-8	134
BC6-P508-02	0-1546942-2	134
BC6-P508-04	0-1546942-4	134
BC6-P508-05	0-1546942-5	134
BC6-P508-06	0-1546942-6	134
BC6-P508-07	0-1546942-7	134
BC6-P508-08	0-1546942-8	134
BC6-P508-09	0-1546942-9	134
BC6-P508-10	1-1546942-0	134
BC6-P508-11	1-1546942-1	134
BC6-P508-12	1-1546942-2	134
BC6-P508-13	1-1546942-3	134
BC6-P508-14	1-1546942-4	134
BC6-P508-15	1-1546942-5	134
BC6-P508-16	1-1546942-6	134

Note: All part numbers are RoHS Compliant.

BUCHANAN Part Number	Tyco Part Number	Page Number
BC6-P508-17	1-1546942-7	134
BC6-P508-18	1-1546942-8	134
BC6-P508-19	1-1546942-9	134
BC6-P508-20	2-1546942-0	134
BC6-Q108-02	0-1546868-2	134
BC6-Q108-04	0-1546868-4	134
BC6-Q307-02	2-0796603-0	134
BC6-Q307-07	2-0796603-1	134
BC6-Q307-09	2-0796603-2	134
BC6-Q307-10	2-0796603-3	134
BC6-Q307-11	2-0796603-4	134
BC6-Q307-12	2-0796603-5	134
BC6-Q307-13	2-0796603-6	134
BC6-Q307-14	2-0796603-7	134
BC6-Q307-15	2-0796603-8	134
BC6-Q307-16	2-0796603-9	134
BC6-Q307-17	3-0796603-0	134
BC6-Q307-18	3-0796603-1	134
BC6-Q308-04	0-1546781-1	134
BC6-Q308-05	0-1546781-2	134
BC6-Q308-07	0-1546781-3	134
BC6-Q308-08	0-1546781-4	134
BC6-Q308-09	0-1546781-5	134
BC6-Q308-11	0-1546781-6	134
BC6-Q308-12	0-1546781-7	134
BC6-Q308-14	0-1546781-8	134
BC6-Q308-16	0-1546781-9	134
BC6-Q308-17	1-1546781-0	134
BC6-Q308-18	1-1546781-1	134
BC6-Q408-02	0-1546867-2	134
BC6-Q408-04	0-1546867-4	134
BC6-Q408-09	0-1546867-9	134
BC6-Q408-11	1-1546867-1	134
BC6-Q408-12	1-1546867-2	134
BC6-Q408-13	1-1546867-3	134
BC6-Q408-15	1-1546867-5	134
BC6-Q408-16	1-1546867-6	134
BC6-Q408-17	1-1546867-7	134
BC6-Q408-18	1-1546867-8	134
BC6-Q408-19	1-1546867-9	134
BC6-Q408-20	2-1546867-0	134
BC6-Q608-02	0-1546783-1	134
BC6-Q608-04	0-1546783-2	134
BC6-Q608-07	0-1546783-3	134
BC6-Q608-08	0-1546783-4	134
BC6-Q608-09	0-1546783-5	134
BC6-Q608-11	0-1546783-6	134
BC6-Q608-12	0-1546783-7	134
BC6-Q608-13	0-1546783-8	134
BC6-Q608-14	0-1546783-9	134
BC6-Q608-15	1-1546783-0	134
BC6-Q608-16	1-1546783-1	134
BC6-Q608-17	1-1546783-2	134
BC6-Q608-18	1-1546783-3	134
BC6-T308-02	0-1546865-2	134
BC6-T308-04	0-1546865-4	134
BC6-T308-05	0-1546865-5	134
BC6-T308-06	0-1546865-6	134
BC6-T308-08	0-1546865-8	134
BC6-T308-09	0-1546865-9	134
BC6-T308-10	1-1546865-0	134
BC6-T308-11	1-1546865-1	134
BC6-T308-12	1-1546865-2	134
BC6-T308-13	1-1546865-3	134
BC6-T308-14	1-1546865-4	134
BC6-T308-15	1-1546865-5	134
BC6-T308-16	1-1546865-6	134
BC6-T308-17	1-1546865-7	134
BC6-T308-18	1-1546865-8	134
BC6-T408-02	9-1437662-6	134
BC6-W108-02	0-1776100-2	134
BC6-W108-03	0-1776100-3	134
BC6-W108-04	0-1776100-4	134
BC6-W108-05	0-1776100-5	134
BC6-W108-06	0-1776100-6	134
BC6-W108-07	0-1776100-7	134
BC6-W108-08	0-1776100-8	134
BC6-W108-10	1-1776100-0	134
BC6-W108-11	1-1776100-1	134
BC6-W108-12	1-1776100-2	134
BC6-W108-13	1-1776100-3	134
BC6-W108-14	1-1776100-4	134
BC6-W108-15	1-1776100-5	134
BC6-W108-16	1-1776100-6	134
BC6-W108-17	1-1776100-7	134
BC6-W108-18	1-1776100-8	134
BC6-W108-19	1-1776100-9	134
BC6-W108-20	2-1776100-0	134
BC6-W308-02	0-1546961-2	134
BC6-W308-02-285	1-1776008-9	134
BC6-W308-03	0-1776008-3	134
BC6-W308-03-286	2-1776008-0	134
BC6-W308-04	0-1776008-4	134
BC6-W308-05	0-1776008-5	134
BC6-W308-06	0-1776008-6	134

BUCHANAN Part Number	Tyco Part Number	Page Number
BC6-W308-07	0-1776008-7	134
BC6-W308-08	0-1776008-8	134
BC6-W308-09	0-1776008-9	134
BC6-W308-10	1-1776008-0	134
BC6-W308-11	1-1776008-1	134
BC6-W308-12	1-1776008-2	134
BC6-W308-13	1-1776008-3	134
BC6-W308-14	1-1776008-4	134
BC6-W308-15	1-1776008-5	134
BC6-W308-16	1-1776008-6	134
BC6-W308-17	1-1776008-7	134
BC6-W308-18	1-1776008-8	134
BC6-W407-03	0-0796968-3	134
BC6-W407-04	0-0796968-4	134
BC6-W408-02	0-1546784-1	134
BC6-W408-05	0-1546784-2	134
BC6-W408-07	0-1546784-3	134
BC6-W408-09	0-1546784-4	134
BC6-W408-11	0-1546784-5	134
BC6-W408-12	0-1546784-6	134
BC6-W408-14	0-1546784-7	134
BC6-W408-15	0-1546784-8	134
BC6-W408-16	0-1546784-9	134
BC6-W408-17	1-1546784-0	134
BC6-W408-18	1-1546784-1	134
BC6-W408-19	1-1546784-2	134
BC6-W408-20	1-1546784-3	134
BP035M	3-1437394-6	251
BP35F	3-1437394-7	251
C102-BU	7-1437382-5	291
C104-BU	7-1437382-6	291
C106-BU	7-1437382-7	291
C108-BU	7-1437382-8	291
C112-BU	7-1437382-9	291
CL101	9-1437382-0	291
CS102	9-1437382-2	291
CS104	9-1437382-3	291
CS106	9-1437382-4	291
CS108	9-1437382-5	291
CS112	9-1437382-6	291
D0211	1437389-2	269
D0212	1437389-4	269
D0213	1437389-6	269
D0221	1437389-7	269
D0222	1437389-8	269
D0223	1437389-9	269
D0241	1776722-1	261
D0242	1776724-1	261
D0243	1-1437389-0	261
D0311	4-1437389-1	282
D0312	1-1437389-2	282
D0318	1776726-1	282
D0371	1-1437389-7	282
D0372	1776731-1	283
D0378	1776729-1	283
D0921	1546144-2	250
D0924	1546148-2	250
D0925	1546235-2	250
D105	2-1437392-9	246
D115	3-1437389-2	246
D125	3-1437389-3	246
D211	3-1437389-4	269
D212	3-1437389-5	269
D213	4-1437389-6	269
D221	3-1437389-6	269
D222	3-1437389-8	269
D223	3-1437389-9	269
D241	4-1437389-0	261
D242	4-1437389-1	261
D243	4-1437389-2	261
D814-BU	5-1437389-8	274
D824	5-1437389-9	274
D921	1546143-2	250
D924	1546147-2	250
D925	1546234-2	250
DP0241	6-1437389-0	261
DP0242	1776724-2	261
DP0243	6-1437389-1	261
DP0311	6-1437389-2	282
DP0312	6-1437389-3	282
DP0318	1776727-1	282
DP0371	1776728-1	282
DP0372	1776732-1	283
DP0378	1776730-1	283
DP125	7-1437389-1	246
DP241	1776721-1	261
DP242	1776723-1	261
DP243	—	261
FACE-40	1437667-1	192
HJ112	1437395-9	291
J10	3-1437392-1	246
J102	1437383-2	291
J104	1437383-3	291
J106	1437383-4	291
J108	1437383-5	291

BUCHANAN Part Number	Tyco Part Number	Page Number
J112	1437383-6	291
J2-BU	3-1437392-2	246
J3 Series	—	120,124,143,145,177
J3140	5-1437418-3	166,169,177
J3-2	3-1437644-4	177
J3-22	3-1437644-5	177
J3-3	1-1437656-0	177
J3-8	3-1437644-6	177
J4 Series	—	124,143,145,177
J4-2	3-1437644-7	177
J4-3	3-1437644-8	177
J4-4	3-1437644-9	177
J4-5	4-1437644-0	177
J4-9	4-1437644-1	177
J6 Series	—	128,134,147,156,171,177,194
J6-10	4-1437644-3	177
J6-11	4-1437644-4	177
J6-13	4-1437644-5	177
J6140	5-1437418-4	156,177,194
J6-16	4-1437644-6	177
J6-20	4-1437644-8	177
J6240	5-1437418-5	156,177,194
J6-3	4-1437644-0	177
J6340	5-1437418-6	156,177,194
J6-4	5-1437644-0	177
J6-6	5-1437644-1	177
J6-7	5-1437644-2	177
J6-8	5-1437644-3	177
J7140	5-1437418-7	158,177
J7240	5-1437418-8	158,177
J7340	5-1437418-9	158,177
J74	6-1437418-0	177,194
J75	6-1437418-1	177,194
J76	1776058-1	158,177
J8 Series	—	136,141,177
J8-2	5-1437644-4	177
J8-3	5-1437644-5	177
J8-4	5-1437644-6	177
JC/BC-Retaining	1437661-7	134,147,153,178
JC6-C707-02	0-1546718-2	147
JC6-C707-02-179	2-1546718-4	147
JC6-C707-02-180	2-1546718-5	147
JC6-C707-02-208	2-1546718-7	147
JC6-C707-03	0-1546718-3	147
JC6-C707-03-209	2-1546718-8	147
JC6-C707-03-210	2-1546718-9	147
JC6-C707-03-211	3-1546718-0	147
JC6-C707-04	0-1546718-4	147
JC6-C707-04-207	2-1546718-6	147
JC6-C707-05	0-1546718-5	147
JC6-C707-05-212	3-1546718-1	147
JC6-C707-05-216	3-1546718-5	147
JC6-C707-06	0-1546718-6	147
JC6-C707-07	0-1546718-7	147
JC6-C707-08	0-1546718-8	147
JC6-C707-09	0-1546718-9	147
JC6-C707-10	1-1546718-0	147
JC6-C707-10-213	3-1546718-2	147
JC6-C707-11	1-1546718-1	147
JC6-C707-11-214	3-1546718-3	147
JC6-C707-12	1-1546718-2	147
JC6-C707-13	1-1546718-3	147
JC6-C707-14	1-1546718-4	147
JC6-C707-15	1-1546718-5	147
JC6-C707-16	1-1546718-6	147
JC6-C707-17	1-1546718-7	147
JC6-C707-18	1-1546718-8	147
JC6-C707-19	1-1546718-9	147
JC6-C707-20	2-1546718-0	147
JC6-C707-20-215	3-1546718-4	147
JC6-C707-21	2-1546718-1	147
JC6-C707-22	2-1546718-2	147
JC6-C707-23	2-1546718-3	147
JC6-C708-02	0-1546719-2	147
JC6-C708-03	0-1546719-3	147
JC6-C708-03-218	2-1546719-5	147
JC6-C708-04	0-1546719-4	147
JC6-C708-05	0-1546719-5	147
JC6-C708-05-217	2-1546719-6	147
JC6-C708-06	0-1546719-6	147
JC6-C708-07	0-1546719-7	147
JC6-C708-08	0-1546719-8	147
JC6-C708-09	0-1546719-9	147
JC6-C708-10	1-1546719-0	147
JC6-C708-11	1-1546719-1	147
JC6-C708-12	1-1546719-2	147
JC6-C708-13	1-1546719-3	147
JC6-C708-14	1-1546719-4	147
JC6-C708-15	1-1546719-5	147
JC6-C708-16	1-1546719-6	147
JC6-C708-17	1-1546719-7	147
JC6-C708-18	1-1546719-8	147
JC6-C708-19	1-1546719-9	147
JC6-C708-20	2-1546719-0	147

Note: All part numbers are RoHS Compliant.

BUCHANAN Part Number	Tyco Part Number	Page Number
JC6-C708-21	2-1546719-1	147
JC6-C708-22	2-1546719-2	147
JC6-C708-23	2-1546719-3	147
JC6-E106-03	2-1546721-6	147
JC6-E107-02	0-1546720-2	147
JC6-E107-03	0-1546720-3	147
JC6-E107-03-181	2-1546720-6	147
JC6-E107-03-221	2-1546720-8	147
JC6-E107-04	0-1546720-4	147
JC6-E107-05	0-1546720-5	147
JC6-E107-06	0-1546720-6	147
JC6-E107-07	0-1546720-7	147
JC6-E107-08	0-1546720-8	147
JC6-E107-09	0-1546720-9	147
JC6-E107-10	1-1546720-0	147
JC6-E107-11	1-1546720-1	147
JC6-E107-12	1-1546720-2	147
JC6-E107-13	1-1546720-3	147
JC6-E107-14	1-1546720-4	147
JC6-E107-15	1-1546720-5	147
JC6-E107-15-182	2-1546720-7	147
JC6-E107-16	1-1546720-6	147
JC6-E107-17	1-1546720-7	147
JC6-E107-18	1-1546720-8	147
JC6-E107-19	1-1546720-9	147
JC6-E107-20	2-1546720-0	147
JC6-E107-21	2-1546720-1	147
JC6-E107-22	2-1546720-2	147
JC6-E107-23	2-1546720-3	147
JC6-E107-24	2-1546720-4	147
JC6-E107-25	2-1546720-5	147
JC6-E108-02	0-1546721-2	147
JC6-E108-03	0-1546721-3	147
JC6-E108-04	0-1546721-4	147
JC6-E108-05	0-1546721-5	147
JC6-E108-06	0-1546721-6	147
JC6-E108-07	0-1546721-7	147
JC6-E108-08	0-1546721-8	147
JC6-E108-09	0-1546721-9	147
JC6-E108-10	1-1546721-0	147
JC6-E108-11	1-1546721-1	147
JC6-E108-12	1-1546721-2	147
JC6-E108-13	1-1546721-3	147
JC6-E108-14	1-1546721-4	147
JC6-E108-15	1-1546721-5	147
JC6-E108-16	1-1546721-6	147
JC6-E108-17	1-1546721-7	147
JC6-E108-18	1-1546721-8	147
JC6-E108-19	1-1546721-9	147
JC6-E108-20	2-1546721-0	147
JC6-E108-21	2-1546721-1	147
JC6-E108-22	2-1546721-2	147
JC6-E108-23	2-1546721-3	147
JC6-E108-24	2-1546721-4	147
JC6-E108-25	2-1546721-5	147
JC6-E206-02	2-1546723-4	147
JC6-E206-06	2-1546723-5	147
JC6-E207-02	0-1546722-2	147
JC6-E207-03	0-1546722-3	147
JC6-E207-04	0-1546722-4	147
JC6-E207-05	0-1546722-5	147
JC6-E207-06	0-1546722-6	147
JC6-E207-07	0-1546722-7	147
JC6-E207-08	0-1546722-8	147
JC6-E207-09	0-1546722-9	147
JC6-E207-10	1-1546722-0	147
JC6-E207-11	1-1546722-1	147
JC6-E207-12	1-1546722-2	147
JC6-E207-13	1-1546722-3	147
JC6-E207-14	1-1546722-4	147
JC6-E207-15	1-1546722-5	147
JC6-E207-16	1-1546722-6	147
JC6-E207-17	1-1546722-7	147
JC6-E207-18	1-1546722-8	147
JC6-E207-19	1-1546722-9	147
JC6-E207-20	2-1546722-0	147
JC6-E207-21	2-1546722-1	147
JC6-E207-22	2-1546722-2	147
JC6-E207-23	2-1546722-3	147
JC6-E208-02	0-1546723-2	147
JC6-E208-03	0-1546723-3	147
JC6-E208-04	0-1546723-4	147
JC6-E208-05	0-1546723-5	147
JC6-E208-06	0-1546723-6	147
JC6-E208-07	0-1546723-7	147
JC6-E208-08	0-1546723-8	147
JC6-E208-09	0-1546723-9	147
JC6-E208-10	1-1546723-0	147
JC6-E208-11	1-1546723-1	147
JC6-E208-12	1-1546723-2	147
JC6-E208-13	1-1546723-3	147
JC6-E208-14	1-1546723-4	147
JC6-E208-15	1-1546723-5	147
JC6-E208-16	1-1546723-6	147
JC6-E208-17	1-1546723-7	147

BUCHANAN Part Number	Tyco Part Number	Page Number
JC6-E208-18	1-1546723-8	147
JC6-E208-19	1-1546723-9	147
JC6-E208-20	2-1546723-0	147
JC6-E208-21	2-1546723-1	147
JC6-E208-22	2-1546723-2	147
JC6-E208-23	2-1546723-3	147
JC6-E307-02	0-1546724-2	147
JC6-E307-03	0-1546724-3	147
JC6-E307-04	0-1546724-4	147
JC6-E307-05	0-1546724-5	147
JC6-E307-06	0-1546724-6	147
JC6-E307-07	0-1546724-7	147
JC6-E307-08	0-1546724-8	147
JC6-E307-09	0-1546724-9	147
JC6-E307-10	1-1546724-0	147
JC6-E307-11	1-1546724-1	147
JC6-E307-12	1-1546724-2	147
JC6-E307-13	1-1546724-3	147
JC6-E307-14	1-1546724-4	147
JC6-E307-15	1-1546724-5	147
JC6-E307-16	1-1546724-6	147
JC6-E307-17	1-1546724-7	147
JC6-E307-18	1-1546724-8	147
JC6-E307-19	1-1546724-9	147
JC6-E307-20	2-1546724-0	147
JC6-E307-21	2-1546724-1	147
JC6-E307-22	2-1546724-2	147
JC6-E307-23	2-1546724-3	147
JC6-E308-02	0-1546725-2	147
JC6-E308-03	0-1546725-3	147
JC6-E308-04	0-1546725-4	147
JC6-E308-05	0-1546725-5	147
JC6-E308-06	0-1546725-6	147
JC6-E308-07	0-1546725-7	147
JC6-E308-08	0-1546725-8	147
JC6-E308-09	0-1546725-9	147
JC6-E308-10	1-1546725-0	147
JC6-E308-11	1-1546725-1	147
JC6-E308-12	1-1546725-2	147
JC6-E308-13	1-1546725-3	147
JC6-E308-14	1-1546725-4	147
JC6-E308-15	1-1546725-5	147
JC6-E308-16	1-1546725-6	147
JC6-E308-17	1-1546725-7	147
JC6-E308-18	1-1546725-8	147
JC6-E308-19	1-1546725-9	147
JC6-E308-20	2-1546725-0	147
JC6-E308-21	2-1546725-1	147
JC6-E308-22	2-1546725-2	147
JC6-E308-23	2-1546725-3	147
JC6-E407-02	0-1546726-2	147
JC6-E407-03	0-1546726-3	147
JC6-E407-04	0-1546726-4	147
JC6-E407-05	0-1546726-5	147
JC6-E407-06	0-1546726-6	147
JC6-E407-07	0-1546726-7	147
JC6-E407-08	0-1546726-8	147
JC6-E407-09	0-1546726-9	147
JC6-E407-10	1-1546726-0	147
JC6-E407-11	1-1546726-1	147
JC6-E407-12	1-1546726-2	147
JC6-E407-13	1-1546726-3	147
JC6-E407-14	1-1546726-4	147
JC6-E407-15	1-1546726-5	147
JC6-E407-16	1-1546726-6	147
JC6-E407-17	1-1546726-7	147
JC6-E407-18	1-1546726-8	147
JC6-E407-19	1-1546726-9	147
JC6-E407-20	2-1546726-0	147
JC6-E407-21	2-1546726-1	147
JC6-E407-22	2-1546726-2	147
JC6-E407-23	2-1546726-3	147
JC6-E407-24	2-1546726-4	147
JC6-E407-25	2-1546726-5	147
JC6-E408-02	0-1546727-2	147
JC6-E408-03	0-1546727-3	147
JC6-E408-04	0-1546727-4	147
JC6-E408-05	0-1546727-5	147
JC6-E408-06	0-1546727-6	147
JC6-E408-07	0-1546727-7	147
JC6-E408-08	0-1546727-8	147
JC6-E408-09	0-1546727-9	147
JC6-E408-10	1-1546727-0	147
JC6-E408-11	1-1546727-1	147
JC6-E408-12	1-1546727-2	147
JC6-E408-13	1-1546727-3	147
JC6-E408-14	1-1546727-4	147
JC6-E408-15	1-1546727-5	147
JC6-E408-16	1-1546727-6	147
JC6-E408-17	1-1546727-7	147
JC6-E408-18	1-1546727-8	147
JC6-E408-19	1-1546727-9	147
JC6-E408-20	2-1546727-0	147
JC6-E408-21	2-1546727-1	147
JC6-E408-22	2-1546727-2	147

BUCHANAN Part Number	Tyco Part Number	Page Number
JC6-E408-23	2-1546727-3	147
JC6-E408-24	2-1546727-4	147
JC6-E408-25	2-1546727-5	147
JC6-P105-12	3-0796985-8	147
JC6-P105-12-165	3-0796985-9	147
JC6-P105-25	0-1776346-1	147
JC6-P106-03	0-1776249-4	147
JC6-P106-04	0-1776249-5	147
JC6-P106-05	0-1776249-6	147
JC6-P106-06	0-1776249-7	147
JC6-P106-07	0-1776249-8	147
JC6-P106-08	0-1776249-9	147
JC6-P106-09	0-1776249-0	147
JC6-P106-12	0-1776249-8	147
JC6-P107-06	—	147
JC6-P107-06-166	1-0796985-1	147
JC6-P107-06-220	0-1776346-2	147
JC6-P107-13-150	0-0796985-7	147
JC6-P107-15	7-0796985-9	147
JC6-P107-17	8-0796985-0	147
JC6-P107-18	8-0796985-1	147
JC6-P107-19	8-0796985-2	147
JC6-P107-21	8-0796985-3	147
JC6-P107-22	8-0796985-4	147
JC6-P107-23	8-0796985-5	147
JC6-P107-24	8-0796985-6	147
JC6-P107-25	8-0796985-7	147
JC6-P108-03-229	0-1776249-9	147
JC6-P108-03-230	1-1776249-0	147
JC6-P108-04-167	1-0796985-2	147
JC6-P108-04-186	0-0796985-8	147
JC6-P108-04-186	0-1546787-1	147
JC6-P108-06-169	1-0796985-4	147
JC6-P108-07	4-0796985-2	147
JC6-P108-09	0-0796985-3	147
JC6-P108-11-170	1-0796985-5	147
JC6-P108-13	4-0796985-3	147
JC6-P108-15	4-0796985-4	147
JC6-P108-18	4-0796985-5	147
JC6-P108-19	4-0796985-6	147
JC6-P108-20	4-0796985-7	147
JC6-P108-21	1-0796985-6	147
JC6-P108-22	4-0796985-8	147
JC6-P108-23	4-0796985-9	147
JC6-P108-24	5-0796985-0	147
JC6-P108-25	5-0796985-1	147
JC6-P207-07	6-0796985-6	147
JC6-P207-11	6-0796985-7	147
JC6-P207-12	6-0796985-8	147
JC6-P207-13	6-0796985-9	147
JC6-P207-14	7-0796985-0	147
JC6-P207-15	7-0796985-1	147
JC6-P207-16	7-0796985-2	147
JC6-P207-17	7-0796985-3	147
JC6-P207-18	7-0796985-4	147
JC6-P207-19	7-0796985-5	147
JC6-P207-21	7-0796985-6	147
JC6-P207-22	7-0796985-7	147
JC6-P207-23	7-0796985-8	147
JC6-P208-03-172	1-0796985-8	147
JC6-P208-07	5-0796985-2	147
JC6-P208-08	5-0796985-3	147
JC6-P208-10	5-0796985-4	147
JC6-P208-11	5-0796985-5	147
JC6-P208-12	5-0796985-6	147
JC6-P208-13	5-0796985-7	147
JC6-P208-14	5-0796985-8	147
JC6-P208-15	1-0796985-9	147
JC6-P208-16	5-0796985-9	147
JC6-P208-17	6-0796985-0	147
JC6-P208-18	2-0796985-0	147
JC6-P208-19	6-0796985-1	147
JC6-P208-20	6-0796985-2	147
JC6-P208-21	6-0796985-3	147
JC6-P208-22	6-0796985-4	147
JC6-P208-22-224	0-1776344-1	147
JC6-P208-23	6-0796985-5	147
JC6-Q206-07	2-1546842-4	147
JC6-Q207-02	0-1546841-2	147
JC6-Q207-05	0-1546841-5	147
JC6-Q207-06	0-1546841-6	147
JC6-Q207-07	0-1546841-7	147
JC6-Q207-08	0-1546841-8	147
JC6-Q207-09	0-1546841-9	147
JC6-Q207-10	1-1546841-0	147
JC6-Q207-11	1-1546841-1	147
JC6-Q207-13	1-1546841-3	147
JC6-Q20		

Note: All part numbers are RoHS Compliant.

BUCHANAN Part Number	Tyco Part Number	Page Number
JC6-Q207-22	2-1546841-2	147
JC6-Q207-23	2-1546841-3	147
JC6-Q208-02	0-1546842-2	147
JC6-Q208-04	0-1546842-4	147
JC6-Q208-05	0-1546842-5	147
JC6-Q208-06	0-1546842-6	147
JC6-Q208-07	0-1546842-7	147
JC6-Q208-08	0-1546842-8	147
JC6-Q208-09	0-1546842-9	147
JC6-Q208-10	1-1546842-0	147
JC6-Q208-11	1-1546842-1	147
JC6-Q208-12	1-1546842-2	147
JC6-Q208-13	1-1546842-3	147
JC6-Q208-14	1-1546842-4	147
JC6-Q208-15	1-1546842-5	147
JC6-Q208-16	1-1546842-6	147
JC6-Q208-17	1-1546842-7	147
JC6-Q208-18	1-1546842-8	147
JC6-Q208-19	1-1546842-9	147
JC6-Q208-20	2-1546842-0	147
JC6-Q208-21	2-1546842-1	147
JC6-Q208-22	2-1546842-2	147
JC6-Q208-23	2-1546842-3	147
JC6-Q305-04	0-1776007-9	147
JC6-Q305-12	4-0796985-0	147
JC6-Q307-05-194	0-1776007-1	147
JC6-Q307-06-203	0-1776007-5	147
JC6-Q307-06-206	0-1776007-6	147
JC6-Q307-08-196	0-1776007-3	147
JC6-Q307-11	0-1546700-1	147
JC6-Q307-13	0-1546700-2	147
JC6-Q307-14	0-1546700-3	147
JC6-Q307-14-195	0-1776007-2	147
JC6-Q307-16-197	0-1776007-4	147
JC6-Q307-17	0-1546700-4	147
JC6-Q307-18	2-0796985-1	147
JC6-Q307-18-225	0-1776007-7	147
JC6-Q307-19	0-1546700-5	147
JC6-Q307-20	0-1546700-6	147
JC6-Q307-21	0-1546700-7	147
JC6-Q307-22	0-1546700-8	147
JC6-Q307-22-226	0-1776007-8	147
JC6-Q307-23	0-1546700-9	147
JC6-Q308-03-173	2-0796985-2	147
JC6-Q308-03-174	2-0796985-3	147
JC6-Q308-05-175	2-0796985-4	147
JC6-Q308-09	1-1546700-0	147
JC6-Q308-10	0-0796985-6	147
JC6-Q308-11	1-1546700-1	147
JC6-Q308-12	0-0796985-9	147
JC6-Q308-12-184	0-1546474-1	147
JC6-Q308-12-232	0-1776501-1	147
JC6-Q308-13	1-1546700-2	147
JC6-Q308-14	1-1546700-3	147
JC6-Q308-15	1-1546700-4	147
JC6-Q308-16	1-1546700-5	147
JC6-Q308-17	1-1546700-6	147
JC6-Q308-18	1-1546700-7	147
JC6-Q308-19	1-1546700-8	147
JC6-Q308-20	1-1546700-9	147
JC6-Q308-21	2-1546700-0	147
JC6-Q308-22	2-1546700-1	147
JC6-Q308-23	2-1546700-2	147
JC6-Q407-05	2-1546700-3	147
JC6-Q407-06	2-1546700-4	147
JC6-Q407-07	2-1546700-5	147
JC6-Q407-08	2-1546700-6	147
JC6-Q407-09	2-1546700-7	147
JC6-Q407-10	2-1546700-8	147
JC6-Q407-11	2-1546700-9	147
JC6-Q407-12	3-1546700-0	147
JC6-Q407-13	3-1546700-1	147
JC6-Q407-14	3-1546700-2	147
JC6-Q407-15	3-1546700-3	147
JC6-Q407-16	3-1546700-4	147
JC6-Q407-17	3-1546700-5	147
JC6-Q407-18	3-1546700-6	147
JC6-Q407-19	3-1546700-7	147
JC6-Q407-20	3-1546700-8	147
JC6-Q407-21	3-1546700-9	147
JC6-Q407-22	4-1546700-0	147
JC6-Q407-23	4-1546700-1	147
JC6-Q407-24	4-1546700-2	147
JC6-Q407-25	4-1546700-3	147
JC6-Q408-03-187	6-1546700-4	147
JC6-Q408-04	4-1546700-4	147
JC6-Q408-07	4-1546700-5	147
JC6-Q408-08	4-1546700-6	147
JC6-Q408-09	4-1546700-7	147
JC6-Q408-10	4-1546700-8	147
JC6-Q408-11	4-1546700-9	147
JC6-Q408-12	5-1546700-0	147
JC6-Q408-13	5-1546700-1	147
JC6-Q408-14	5-1546700-2	147
JC6-Q408-15	5-1546700-3	147

BUCHANAN Part Number	Tyco Part Number	Page Number
JC6-Q408-16	5-1546700-4	147
JC6-Q408-17	5-1546700-5	147
JC6-Q408-18	5-1546700-6	147
JC6-Q408-19	5-1546700-7	147
JC6-Q408-20	5-1546700-8	147
JC6-Q408-21	5-1546700-9	147
JC6-Q408-22	6-1546700-0	147
JC6-Q408-23	6-1546700-1	147
JC6-Q408-24	6-1546700-2	147
JC6-Q408-25	6-1546700-3	147
JC6-T207-05-148	3-0796985-4	147
JC6-T207-06	0-0796985-2	147
JC6-T207-07	1-1546701-3	147
JC6-T207-09	1-1546701-4	147
JC6-T207-11	1-1546701-5	147
JC6-T207-12	1-1546701-6	147
JC6-T207-13	1-1546701-7	147
JC6-T207-14	1-1546701-8	147
JC6-T207-15	1-1546701-9	147
JC6-T207-16	2-1546701-0	147
JC6-T207-17	2-1546701-1	147
JC6-T207-18	2-1546701-2	147
JC6-T207-19	2-1546701-3	147
JC6-T207-20	2-1546701-4	147
JC6-T207-21	2-1546701-5	147
JC6-T207-22	2-1546701-6	147
JC6-T207-23	2-1546701-7	147
JC6-T208-03	0-0796985-1	147
JC6-T208-06	0-1546840-6	147
JC6-T208-07	0-1546840-7	147
JC6-T208-08	0-1546840-8	147
JC6-T208-09	0-1546840-9	147
JC6-T208-10	1-1546840-0	147
JC6-T208-11	1-1546840-1	147
JC6-T208-12	1-1546840-2	147
JC6-T208-13	1-1546840-3	147
JC6-T208-14	1-1546840-4	147
JC6-T208-15	1-1546840-5	147
JC6-T208-16	1-1546840-6	147
JC6-T208-17	1-1546840-7	147
JC6-T208-18	1-1546840-8	147
JC6-T208-19	1-1546840-9	147
JC6-T208-20	2-1546840-0	147
JC6-T208-21	2-1546840-1	147
JC6-T208-22	2-1546840-2	147
JC6-T208-23	2-1546840-3	147
JC6-T305-07-219	0-1776006-4	147
JC6-T305-12-204	4-0796985-1	147
JC6-T305-20	0-1776006-5	147
JC6-T305-20-205	8-0796985-9	147
JC6-T307-09-192	0-1776006-2	147
JC6-T307-11	0-1546701-6	147
JC6-T307-12-191	0-1776006-1	147
JC6-T307-13	0-1546701-2	147
JC6-T307-14	0-1546701-3	147
JC6-T307-14-193	0-1776006-3	147
JC6-T307-15	0-1546701-4	147
JC6-T307-16	0-1546701-5	147
JC6-T307-17	0-1546701-7	147
JC6-T307-19	0-1546701-8	147
JC6-T307-20	0-1546701-9	147
JC6-T307-21	1-1546701-0	147
JC6-T307-22	1-1546701-1	147
JC6-T307-23	1-1546701-2	147
JC6-T308-07	2-1546701-9	147
JC6-T308-11	3-1546701-0	147
JC6-T308-12	3-1546701-1	147
JC6-T308-13	3-1546701-2	147
JC6-T308-14	3-1546701-3	147
JC6-T308-15	3-1546701-4	147
JC6-T308-16	3-1546701-5	147
JC6-T308-17	3-1546701-6	147
JC6-T308-18	3-1546701-7	147
JC6-T308-19	3-1546701-8	147
JC6-T308-20	3-1546701-9	147
JC6-T308-21	4-1546701-0	147
JC6-T308-22	4-1546701-1	147
JC6-T308-23	4-1546701-2	147
JC6-T407-02	4-1546701-3	147
JC6-T407-06	4-1546701-4	147
JC6-T407-07	4-1546701-5	147
JC6-T407-08	4-1546701-6	147
JC6-T407-10	4-1546701-7	147
JC6-T407-11	4-1546701-8	147
JC6-T407-12	4-1546701-9	147
JC6-T407-13	5-1546701-0	147
JC6-T407-14	5-1546701-1	147
JC6-T407-15	5-1546701-2	147
JC6-T407-16	5-1546701-3	147
JC6-T407-17	5-1546701-4	147
JC6-T407-18	5-1546701-5	147
JC6-T407-19	5-1546701-6	147
JC6-T407-20	5-1546701-7	147
JC6-T407-21	5-1546701-8	147
JC6-T407-22	5-1546701-9	147

BUCHANAN Part Number	Tyco Part Number	Page Number
JC6-T407-23	6-1546701-0	147
JC6-T407-24	6-1546701-1	147
JC6-T407-25	6-1546701-2	147
JC6-T408-02	6-1546701-3	147
JC6-T408-03	6-1546701-4	147
JC6-T408-04	2-0796985-5	147
JC6-T408-05	2-0796985-6	147
JC6-T408-06	6-1546701-5	147
JC6-T408-07	6-1546701-6	147
JC6-T408-08	6-1546701-7	147
JC6-T408-10	6-1546701-8	147
JC6-T408-11	6-1546701-9	147
JC6-T408-12	7-1546701-0	147
JC6-T408-13	7-1546701-1	147
JC6-T408-14	7-1546701-2	147
JC6-T408-15	7-1546701-3	147
JC6-T408-16	7-1546701-4	147
JC6-T408-17	7-1546701-5	147
JC6-T408-18	7-1546701-6	147
JC6-T408-19	7-1546701-7	147
JC6-T408-20	7-1546701-8	147
JC6-T408-22	7-1546701-9	147
JC6-T408-23	8-1546701-0	147
JC6-T408-25	8-1546701-1	147
JC6-W107-02	4-1546703-0	147
JC6-W107-03-233	0-1776228-2	147
JC6-W107-04	4-1546703-1	147
JC6-W107-04-176	2-0796985-7	147
JC6-W107-04-202	0-1776228-1	147
JC6-W107-06	2-0796985-8	147
JC6-W107-07	4-1546703-2	147
JC6-W107-08	4-1546703-3	147
JC6-W107-09	4-1546703-4	147
JC6-W107-10	0-0796985-4	147
JC6-W107-11	4-1546703-5	147
JC6-W107-12	4-1546703-6	147
JC6-W107-13	4-1546703-7	147
JC6-W107-14	4-1546703-8	147
JC6-W107-15	4-1546703-9	147
JC6-W107-16	5-1546703-0	147
JC6-W107-17	5-1546703-1	147
JC6-W107-18	5-1546703-2	147
JC6-W107-19	5-1546703-3	147
JC6-W107-20	5-1546703-4	147
JC6-W107-21	5-1546703-5	147
JC6-W107-22	5-1546703-6	147
JC6-W107-23	5-1546703-7	147
JC6-W107-24	5-1546703-8	147
JC6-W107-25	5-1546703-9	147
JC6-W108-02	2-1546703-0	147
JC6-W108-03-231	0-1776175-5	147
JC6-W108-04	2-1546703-1	147
JC6-W108-05-199	0-1776175-2	147
JC6-W108-06	2-1546703-2	147
JC6-W108-06-200	0-1776175-3	147
JC6-W108-06-234	0-1776175-6	147
JC6-W108-07	2-1546703-3	147
JC6-W108-08	2-1546703-4	147
JC6-W108-08-201	0-1776175-4	147
JC6-W108-09	2-1546703-5	147
JC6-W108-10	2-1546703-6	147
JC6-W108-11	2-1546703-7	147
JC6-W108-12	2-0796985-9	147
JC6-W108-12-198	0-1776175-1	147
JC6-W108-13	2-1546703-8	147
JC6-W108-14	2-1546703-9	147
JC6-W108-15	3-1546703-0	147
JC6-W108-16	3-1546703-1	147
JC6-W108-17	3-1546703-2	147
JC6-W108-18	3-1546703-3	147
JC6-W108-19	3-1546703-4	147
JC6-W108-20	3-0796985-0	147
JC6-W108-21	3-1546703-5	147
JC6-W108-22	3-1546703-6	147
JC6-W108-23	3-1546703-7	147
JC6-W108-24	3-1546703-8	147
JC6-W108-25	3-1546703-9	147
JC6-W205-08	3-0796985-1	147
JC6-W207-03	0-1546703-1	147
JC6-W207-04	0-1546703-2	147
JC6-W207-04-227	0-1776345-1	147
JC6-W207-06	0-0796985-5	147
JC6-W207-07	0-1546703-3	147
JC6-W207-08	0-1546703-4	147
JC6-W207-09	0-1546703-5	147
JC6-W207-10	0-15467	

Note: All part numbers are RoHS Compliant.

BUCHANAN Part Number	Tyco Part Number	Page Number
JC6-W207-20	1-1546703-6	147
JC6-W207-21	1-1546703-7	147
JC6-W207-22	1-1546703-8	147
JC6-W207-23	1-1546703-9	147
JC6-W208-03	7-1546702-2	147
JC6-W208-03-188	8-1546702-8	147
JC6-W208-04-183	0-1546752-1	147
JC6-W208-07	3-0796985-2	147
JC6-W208-08	7-1546702-3	147
JC6-W208-09	7-1546702-4	147
JC6-W208-09-223	0-1546752-2	147
JC6-W208-10	7-1546702-5	147
JC6-W208-11	7-1546702-6	147
JC6-W208-13	7-1546702-7	147
JC6-W208-14	7-1546702-8	147
JC6-W208-15	7-1546702-9	147
JC6-W208-16	8-1546702-0	147
JC6-W208-17	8-1546702-1	147
JC6-W208-18	8-1546702-2	147
JC6-W208-19	8-1546702-3	147
JC6-W208-20	8-1546702-4	147
JC6-W208-21	8-1546702-5	147
JC6-W208-22	8-1546702-6	147
JC6-W208-23	8-1546702-7	147
JC6-W307-03-190	8-1546702-9	147
JC6-W307-05	5-1546702-9	147
JC6-W307-11	6-1546702-0	147
JC6-W307-12	6-1546702-1	147
JC6-W307-14	6-1546702-2	147
JC6-W307-15	6-1546702-3	147
JC6-W307-16	6-1546702-4	147
JC6-W307-17	6-1546702-5	147
JC6-W307-18	6-1546702-6	147
JC6-W307-19	6-1546702-7	147
JC6-W307-20	6-1546702-8	147
JC6-W307-21	6-1546702-9	147
JC6-W307-22	7-1546702-0	147
JC6-W307-23	7-1546702-1	147
JC6-W308-03	4-1546702-2	147
JC6-W308-03-177	3-0796985-3	147
JC6-W308-04	4-1546702-3	147
JC6-W308-06	4-1546702-4	147
JC6-W308-07	4-1546702-5	147
JC6-W308-09	4-1546702-6	147
JC6-W308-10	4-1546702-7	147
JC6-W308-11	4-1546702-8	147
JC6-W308-13	4-1546702-9	147
JC6-W308-15	5-1546702-0	147
JC6-W308-16	5-1546702-1	147
JC6-W308-17	5-1546702-2	147
JC6-W308-18	5-1546702-3	147
JC6-W308-19	5-1546702-4	147
JC6-W308-20	5-1546702-5	147
JC6-W308-21	5-1546702-6	147
JC6-W308-22	5-1546702-7	147
JC6-W308-23	5-1546702-8	147
JC6-W405-16	0-1546751-1	147
JC6-W405-16-164	3-0796985-5	147
JC6-W406-04	3-0796985-6	147
JC6-W406-05	3-0796985-7	147
JC6-W407-04	2-1546702-2	147
JC6-W407-05	2-1546702-3	147
JC6-W407-06	2-1546702-4	147
JC6-W407-08	2-1546702-5	147
JC6-W407-08-228	0-1546751-2	147
JC6-W407-09	2-1546702-6	147
JC6-W407-10	2-1546702-7	147
JC6-W407-11	2-1546702-8	147
JC6-W407-13	2-1546702-9	147
JC6-W407-14	3-1546702-0	147
JC6-W407-15	3-1546702-1	147
JC6-W407-16	3-1546702-2	147
JC6-W407-17	3-1546702-3	147
JC6-W407-18	3-1546702-4	147
JC6-W407-19	3-1546702-5	147
JC6-W407-20	3-1546702-6	147
JC6-W407-21	3-1546702-7	147
JC6-W407-22	3-1546702-8	147
JC6-W407-23	3-1546702-9	147
JC6-W407-24	4-1546702-0	147
JC6-W407-25	4-1546702-1	147
JC6-W408-02	0-1546702-1	147
JC6-W408-05	0-1546702-2	147
JC6-W408-06	0-1546702-3	147
JC6-W408-07	0-1546702-4	147
JC6-W408-08	0-1546702-5	147
JC6-W408-09	0-1546702-6	147
JC6-W408-10	0-1546702-7	147
JC6-W408-11	0-1546702-8	147
JC6-W408-13	0-1546702-9	147
JC6-W408-14	1-1546702-0	147
JC6-W408-15	1-1546702-1	147
JC6-W408-16	1-1546702-2	147
JC6-W408-17	1-1546702-3	147
JC6-W408-18	1-1546702-4	147

BUCHANAN Part Number	Tyco Part Number	Page Number
JC6-W408-19	1-1546702-5	147
JC6-W408-20	1-1546702-6	147
JC6-W408-21	1-1546702-7	147
JC6-W408-22	1-1546702-8	147
JC6-W408-23	1-1546702-9	147
JC6-W408-24	2-1546702-0	147
JC6-W408-25	2-1546702-1	147
L01	2-1437402-4	171,178
L02	2-1437402-5	171,178
L03	2-1437402-6	128,134,147,149,178
L04	2-1437402-7	171,178
L09	2-1437402-8	171,178
L91	5-1437402-1	153,178
L92	5-1437402-2	153
LN101-BU	1437383-7	291
M1000BZ02	—	237
M1000BZ03	—	237
M1000BZ04	—	237
M1000BZ05	—	237
M1000BZ06	—	237
M1000BZ07	—	237
M1000BZ08	1546830-8	237
M1000BZ09	—	237
M1000BZ10	—	237
M1000BZ11	—	237
M1000BZ12	1437387-6	237
M1500BZ02	—	237
M1500BZ03	—	237
M1500BZ04	—	237
M1500BZ05	—	237
M1500BZ06	—	237
M1500BZ07	—	237
M1500BZ08	—	237
M1500BZ09	—	237
M1500BZ10	—	237
M1500BZ11	—	237
M1500BZ12	—	237
M2000BZ02	—	237
M2000BZ03	—	237
M2000BZ04	—	237
M2000BZ05	—	237
M2000BZ06	—	237
M2000BZ07	—	237
M2000BZ08	—	237
M2000BZ09	—	237
M2000BZ10	—	237
M2000BZ11	—	237
M2000BZ12	—	237
M230BZ02	—	237
M230BZ03	1-1437387-5	237
M230BZ04	1-1437387-6	237
M230BZ05	—	237
M230BZ06	—	237
M230BZ07	—	237
M230BZ08	—	237
M230BZ09	1-1437387-7	237
M230BZ10	1-1437387-8	237
M230BZ11	—	237
M230BZ12	1-1437387-9	237
M5000S13G	—	293
M500BZ02	—	237
M500BZ03	—	237
M500BZ04	—	237
M500BZ05	—	237
M500BZ06	2-1437387-3	237
M500BZ07	—	237
M500BZ08	—	237
M500BZ09	—	237
M500BZ10	—	237
M500BZ11	—	237
M500BZ12	2-1437387-4	237
MB6-P108-04	2-1437663-8	135
MB6-P108-06	2-1437663-9	135
MB6-P108-08	3-1437663-0	135
MB6-P108-10	3-1437663-1	135
MB6-P108-12	3-1437663-2	135
MB6-P108-14	3-1437663-3	135
MB6-P108-16	3-1437663-4	135
MB6-P108-18	3-1437663-5	135
MB6-P108-20	3-1437663-6	135
N06	1776733-2	291
N104	1-1437383-1	291
N106	1-1437383-2	291
N108	1-1437383-3	291
N112	1-1437383-4	291
NC6-P102-02	6-1437664-4	149
NC6-P102-04	1437664-3	149
NC6-P102-12	6-1437664-3	149
NC6-P104-14	1437656-6	149
NC6-P106-04	6-1437664-2	149
NC6-P107-02	1437664-4	149
NC6-P107-03	1437664-5	149
NC6-P107-04	1437664-6	149
NC6-P107-05	1437664-7	149
NC6-P107-06	1437664-9	149

BUCHANAN Part Number	Tyco Part Number	Page Number
NC6-P107-07	1-1437664-0	149
NC6-P107-08	1-1437664-1	149
NC6-P107-09	1-1437664-3	149
NC6-P107-10	1-1437664-4	149
NC6-P107-11	1-1437664-6	149
NC6-P107-12	1-1437664-7	149
NC6-P107-13	1-1437664-8	149
NC6-P107-14	2-1437664-0	149
NC6-P107-15	2-1437664-1	149
NC6-P107-16	2-1437664-2	149
NC6-P107-17	2-1437664-3	149
NC6-P107-20	2-1437664-5	149
NC6-P107-22	2-1437664-6	149
NC6-P107-24	2-1437664-7	149
NC6-P107-25	2-1437664-8	149
NC6-P108-02	3-1437664-0	149
NC6-P108-03	3-1437664-1	149
NC6-P108-04	3-1437664-3	149
NC6-P108-05	3-1437664-5	149
NC6-P108-06	3-1437664-8	149
NC6-P108-06-049	3-1437664-9	149
NC6-P108-07	4-1437664-0	149
NC6-P108-08	4-1437664-1	149
NC6-P108-09	4-1437664-2	149
NC6-P108-10	4-1437664-4	149
NC6-P108-11	4-1437664-6	149
NC6-P108-12	4-1437664-7	149
NC6-P108-13	4-1437664-8	149
NC6-P108-14	4-1437664-9	149
NC6-P108-15	5-1437664-0	149
NC6-P108-16	5-1437664-1	149
NC6-P108-17	5-1437664-2	149
NC6-P108-18	5-1437664-3	149
P0241	5-1437390-9	260
P0242	6-1437390-0	260
P0243-BU	6-1437390-2	260
P0248	6-1437390-3	260
P0250	6-1437390-4	260,261
P0311	4-1437397-0	282
P0312	4-1437397-2	282
P0318	4-1437397-3	282
P0371	4-1437397-4	282
P0372	4-1437397-5	283
P0378	4-1437397-6	283
P0380	4-1437397-7	282,283
P0625	6-1437393-4	244
P125	4-1437392-7	246
P130	4-1437392-9	246
P241	6-1437390-5	260
P242	6-1437390-6	260
P243	6-1437390-7	260
P248	6-1437390-8	260
P250	6-1437390-9	260,261
PC17	1437410-5	190,191,193,194
PC18	6-1437418-2	190
PC19	1437410-6	190
PCB1A12A	1437410-8	182
PCB1A12S	1437410-9	182
PCB1A18A	1-1437410-0	182
PCB1A18S	1-1437410-1	182
PCB1A24A	1-1437410-2	182
PCB1A24S	1-1437410-3	182
PCB1A30A	1-1437410-4	182
PCB1A30S	1-1437410-5	182
PCB1A36A	1-1437410-6	182
PCB1A36S	1-1437410-7	182
PCB1B06S	1-1437410-8	183
PCB1B08AG	1-1437410-9	183
PCB1B08S	2-1437410-0	183
PCB1B10A	2-1437410-1	183
PCB1B10AG	2-1437410-2	183
PCB1B10S	2-1437410-3	183
PCB1B10SG	2-1437410-4	183
PCB1B12A	2-1437410-5	183
PCB1B12AG	2-1437410-6	183
PCB1B12S	2-1437410-7	183
PCB1B12SG	2-1437410-8	183
PCB1B15A	2-1437410-9	183
PCB1B15AG	3-1437410-0	183
PCB1B15S	3-1437410-1	183
PCB1B16AG	3-1437410-2	183
PCB1B16S	—	183
PCB1B16SG	1776774-8	183
PCB1B18A	3-1437410-3	183
PCB1B18AG	3-1437410-4	183
PCB1B18S	3-1437410-5	183
PCB1B18SG	3-1437410-6	183
PCB1B22A	3-1437410-7	183
PCB1B22AG	3-1437410-8	183
PCB1B22S	4-1437410-0	183
PCB1B22SG	4-1437410-1	183
PCB1B24S	—	183
PCB1B24S	1776774-7	183
PCB1B28A	4-1437410-2	183

Note: All part numbers are RoHS Compliant.

BUCHANAN Part Number	Tyco Part Number	Page Number
PCB1B28AG	4-1437410-3	183
PCB1B28S	4-1437410-4	183
PCB1B28SG	4-1437410-5	183
PCB1B30S	—	183
PCB1B30S	1776774-1	183
PCB1B30SG	4-1437410-6	183
PCB1B32A	4-1437410-7	183
PCB1B32AG	4-1437410-8	183
PCB1B32S	4-1437410-9	183
PCB1B32SG	5-1437410-0	183
PCB1B36A	5-1437410-1	183
PCB1B36AG	5-1437410-2	183
PCB1B36S	5-1437410-3	183
PCB1B36SG	5-1437410-4	183
PCB1B43A	5-1437410-5	183
PCB1B43AG	5-1437410-6	183
PCB1B43S	5-1437410-7	183
PCB1B43SG	5-1437410-8	183
PCB2B	—	184
PCB2B06A	5-1437410-9	184
PCB2B06S	6-1437410-1	184
PCB2B08A	6-1437410-2	184
PCB2B08S	6-1437410-3	184
PCB2B09S	6-1437410-4	184
PCB2B10A	6-1437410-5	184
PCB2B10S	6-1437410-6	184
PCB2B12A	6-1437410-7	184
PCB2B12S	6-1437410-8	184
PCB2B15A	6-1437410-9	184
PCB2B15S	7-1437410-0	184
PCB2B16A	7-1437410-1	184
PCB2B16S	7-1437410-2	184
PCB2B18A	7-1437410-3	184
PCB2B18S	7-1437410-4	184
PCB2B22A	7-1437410-5	184
PCB2B22S	7-1437410-6	184
PCB2B24A	7-1437410-7	184
PCB2B24S	—	184
PCB2B28A	7-1437410-8	184
PCB2B28S	7-1437410-9	184
PCB2B30A	8-1437410-0	184
PCB2B30S	8-1437410-1	184
PCB2B32S	—	184
PCB2B36A	8-1437410-2	184
PCB2B36S	8-1437410-3	184
PCB2B43A	8-1437410-4	184
PCB2B43S	8-1437410-5	184
PCB3A06A	8-1437410-7	185
PCB3A06S	8-1437410-8	185
PCB3A08A	8-1437410-9	185
PCB3A08S	9-1437410-0	185
PCB3A10A	9-1437410-1	185
PCB3A10S	9-1437410-2	185
PCB3A12A	9-1437410-3	185
PCB3A12S	9-1437410-4	185
PCB3A15A	9-1437410-5	185
PCB3A15S	9-1437410-6	185
PCB3A16A	9-1437410-7	185
PCB3A16S	9-1437410-8	185
PCB3A18A	9-1437410-9	185
PCB3A18S	1437411-2	185
PCB3A20S	2-1546107-0	185
PCB3A22A	1437411-3	185
PCB3A22S	1437411-4	185
PCB3A24A	1437411-5	185
PCB3A24S	1437411-6	185
PCB3A30A	1437411-7	185
PCB3A30S	1437411-8	185
PCB3A32A	1437411-9	185
PCB3A32S	1-1437411-0	185
PCB3A34S	3-1546107-4	185
PCB3A36A	1-1437411-1	185
PCB3A36S	1-1437411-3	185
PCB3A44A	1-1437411-4	185
PCB3A44S	1-1437411-5	185
PCB3D20A	1-1437411-6	187
PCB3D20S	1-1437411-7	187
PCB3D30A	1-1437411-8	187
PCB3D30S	1-1437411-9	187
PCB3D36A	2-1437411-0	187
PCB3D36S	2-1437411-1	187
PCB3D44A	2-1437411-2	187
PCB3D44S	2-1437411-3	187
PCB3S10A	2-1437411-4	186
PCB3S10S	1-1546928-0	186
PCB3S15A	2-1437411-5	186
PCB3S15S	2-1437411-6	186
PCB3S18S	1-1546928-8	186
PCB3S22S	2-1437411-7	186
PCB3S22A	2-1437411-8	186
PCB3S22S	2-1437411-9	186
PCB5B36A	3-1437411-0	188
PCBJ1	6-1437418-4	190
PCBJ2	6-1437418-5	190
PCBJ3	—	190

BUCHANAN Part Number	Tyco Part Number	Page Number
PSB3KB08SNNNN	—	189
PSB3KC06S	1-1437406-5	189
PSB3KC06SNN26	1-1437406-6	189
PSB3KC08A	1-1437406-7	189
PSB3KC08S	1-1437406-8	189
PSB3KC08SNN26	1-1437406-9	189
PSB3KC10S	2-1437406-0	189
PSB3KC12A	2-1437406-2	189
PSB3KC12S	2-1437406-3	189
PSB3KC14S	2-1437406-4	189
PSB3KC16A	2-1437406-5	189
PSB3KC16S	2-1437406-6	189
PSB3KC18A	2-1437406-8	189
PSB3KC18S	2-1437406-9	189
PSB3KC20S	3-1437406-0	189
PSB3KC22S	3-1437406-1	189
PSB3KC24S	3-1437406-2	189
PSB3KC28SNN24	3-1437406-3	189
PSB3KC06	1-1437409-4	191
PSB3KC08	3-1437406-4	189
PSB3KCC10	1437409-6	191
PSB3KCC12	1437409-7	191
PSB3KCC14	1437409-8	191
PSB3KCC16	1437409-9	191
PSB3KCC18	1-1437409-0	191
PSB3KCC20	1-1437409-3	191
PSB3KCC22	3-1437406-6	191
PSB3KCC24	3-1437409-5	191
PSB3KCC26	1-1437409-1	191
PSB3KCC28	—	191
PSB4KC06A	5-1437406-3	191
PSB4KC06S	5-1437406-4	191
PSB4KC08A	5-1437406-5	191
PSB4KC08ANN25	5-1437406-6	191
PSB4KC08S	5-1437406-7	191
PSB4KC10S	5-1437406-8	191
PSB4KC10SNN25	5-1437406-9	191
PSB4KC12A	6-1437406-0	191
PSB4KC12S	6-1437406-1	191
PSB4KC14A	6-1437406-2	191
PSB4KC14S	6-1437406-3	191
PSB4KC16A	6-1437406-4	191
PSB4KC16S	6-1437406-5	191
PSB4KC18A	6-1437406-6	191
PSB4KC18S	6-1437406-7	191
PSB4KC20A	6-1437406-8	191
PSB4KC20S	6-1437406-9	191
PSB4KC22A	7-1437406-0	191
PSB4KC22S	7-1437406-1	191
PSB4KC24A	7-1437406-2	191
PSB4KC24S	7-1437406-3	191
PSB4KC26A	7-1437406-4	191
QC1	—	169
QC10	5-1437402-7	176
QC11	5-1437402-8	176
QC12	5-1437402-9	176
QC13	6-1437402-0	176
QC14	6-1437402-1	176
QC15-BU	6-1437402-2	176
QC2	—	134,147,153
QC20-BU	1546986-1	176
QC21	1546986-3	176
QC21	6-1437418-6	191
QC22	1546986-4	176
QC22	6-1437402-4	191
QC23	6-1437402-5	176,191
QC24	6-1437402-6	176,191
QC25	6-1437402-7	176,194
QC4	—	134,143,147,153,176
QC40-BU	6-1437402-9	176
QC41	7-1437402-0	176,194
QC41803	5-1437644-7	176
QC42	7-1437402-1	176,194
QC43	7-1437402-2	176,194
QC44	7-1437402-3	176,194
QC45	7-1437402-4	176,194
QC6-180-3	5-1437644-8	191
QC6-180-4	5-1437644-9	191
QC6-245-4	6-1437644-0	191
QC6-290-4	6-1437644-1	191
QC6-45-3	6-1437644-2	191
QC6-45-3-C	6-1437644-3	191
QC6-45-4	6-1437644-4	191
QC6-90-3	6-1437644-5	191
QC6-90-4	6-1437644-6	191
QC70	7-1437402-5	176
QC71	7-1437402-6	176
QC72	7-1437402-7	176
QC73	7-1437402-8	176
QC74	7-1437402-9	176
QC75	8-1437402-0	176
QC8-180-4	6-1437644-7	191
QC8-45-4	6-1437644-8	191
QC8-90-4	6-1437644-9	191
R10	—	207

BUCHANAN Part Number	Tyco Part Number	Page Number
RB1	—	205,206
RB1-AG	2-1437683-3	212
RB4	—	207
RB4-AG	2-1437683-5	212
RB5	—	206
RB5-AG	2-1437683-6	212
RSB3	—	115,161,162,164,165,166,175,178
RSB3VP0212	—	162
RSB3VP021201	1-1437404-5	162
RSB3VP021202	1-1437404-6	162
RSB3VP02120222	1-1437404-7	162
RSB3VP0312	—	162
RSB3VP031201N	1-1437404-8	162
RSB3VP031202	1-1437404-9	162
RSB3VP0412	—	162
RSB3VP041201	2-1437404-0	162
RSB3VP041202	2-1437404-1	162
RSB3VP0512	—	162
RSB3VP051201	2-1437404-2	162
RSB3VP051202	2-1437404-3	162
RSB3VP05120222	2-1437404-4	162
RSB3VP0612	—	162
RSB3VP061201	2-1437404-5	162
RSB3VP061202	2-1437404-6	164
RSB3VP06120211	—	165
RSB3VP0712	—	162
RSB3VP071201	2-1437404-7	162
RSB3VP071202	2-1437404-8	162
RSB3VP0812	—	162
RSB3VP081202	2-1437404-9	162
RSB3VP0912	—	162
RSB3VP091202	3-1437404-0	162
RSB3VP1012	—	162
RSB3VP101201	3-1437404-2	162
RSB3VP101202	3-1437404-3	162
RSB3VP10120221	3-1437404-4	162
RSB3VP1112	—	162
RSB3VP111202	3-1437404-6	162
RSB3VP1212	—	162
RSB3VP121201	3-1437404-7	162
RSB3VP121202	3-1437404-8	162
RSB3VP1312	—	162
RSB3VP131202	4-1437404-0	162
RSB3VP1412	—	162
RSB3VP141201	4-1437404-1	162
RSB3VP141202	4-1437404-2	162
RSB3VP151202	4-1437404-3	162
RSB3VP161202	4-1437404-4	162
RSB3VP161202NN60	4-1437404-5	162
RSB3VP171202	4-1437404-6	162
RSB3VP181202	4-1437404-8	162
RSB3VP201202	4-1437404-9	162
RSB3VP211202	5-1437404-0	162
RSB3VP241202	5-1437404-1	162
RSB6	—	115,161,163,171,172,173,175,177,178
RSB6B	—	161,163
RSB6B02S	1437407-3	163
RSB6B03S	1437407-4	163
RSB6B04S	1437407-5	163
RSB6B05S	796633-1	163
RSB6B06S	1437407-6	163
RSB6B07S	796633-2	163
RSB6B08S	796633-3	163
RSB6B09S	796633-4	163
RSB6B10S	1437407-7	163
RSB6RP07120211	—	172
RSB6VP021202	5-1437407-8	172
RSB6VP031201	6-1437407-2	172
RSB6VP031202	6-1437407-3	172
RSB6VP031209	6-1437407-6	172
RSB6VP031225	6-1437407-7	172
RSB6VP031902	6-1437407-8	172
RSB6VP041201	6-1437407-9	172
RSB6VP041202	7-1437407-0	172
RSB6VP041203	7-1437407-2	172
RSB6VP051201	7-1437407-3	172
RSB6VP051202	7-1437407-4	172
RSB6VP051203	7-1437407-5	172
RSB6VP061201	7-1437407-7	172
RSB6VP061202	7-1437407-9	172
RSB6VP06120212AF	8-1437407-0	172
RSB6VP061203	8-1437407-2	172
RSB6VP061203NN60	8-1437407-3	172
RSB6VP061209	8-1437407-4	172
RSB6VP061903	796609-1	172
RSB6VP071201	8-1437407-5	172
RSB6VP071202	8-1437407-6	172
RSB6VP071902	8-1437407-7	172
RSB6VP081202	8-1437407-8	172
RSB6VP08120221	8-1437407-9	172
RSB6VP081203	9-1437407-1	172
RSB6VP081209	9-1437407-2	172
RSB6VP081901	9-1437407-3	172

Note: All part numbers are RoHS Compliant.

BUCHANAN Part Number	Tyco Part Number	Page Number
RSB6VP091202	9-1437407-4	172
RSB6VP101201	9-1437407-7	172
RSB6VP10120111	9-1437407-8	172
RSB6VP10120121	9-1437407-9	172
RSB6VP101202	1437408-1	172
RSB6VP1012021	1437408-2	172
RSB6VP10120212AK	1437408-3	172
RSB6VP101203NN60	1437408-5	172
RSB6VP101229	1437408-6	172
RSB6VP111202	1437408-7	172
RSB6VP121202	1437408-8	172
RSB6VP12120221	1437408-9	172
RSB6VP131202	1-1437408-0	172
RSB6VP131203NN60	1-1437408-1	172
RSB6VP141202	1-1437408-2	172
RSB6VP151201	1-1437408-3	172
RSB6VP151202	1-1437408-4	172
RSB6VP151203	1-1437408-5	172
RSB6VP161202	1-1437408-6	172
RSB6VP161203	2-1437408-0	172
RSB6VP181202	2-1437408-1	172
RSB6VP181203	2-1437408-3	172
RSB6VP191202	2-1437408-4	172
RSB6VP191204	2-1437408-5	172
RSB6VP201202	2-1437408-6	172
RSB6VP211202	2-1437408-7	172
RSB6VP221202	2-1437408-8	172
RSB6VP221203	2-1437408-9	172
RSB6VP221203NN60	3-1437408-0	172
RSB6VP231202	3-1437408-1	172
RSB6VP241202	3-1437408-2	172
RSB6VP241203	3-1437408-3	172
RSB6VP271201	3-1437408-4	172
RSB6VP271202	3-1437408-5	172
RSB6VP281202	3-1437408-6	172
RSB6VP291202	3-1437408-7	172
ST102	1-1437383-5	291
ST104	1-1437383-6	291
ST106	1-1437383-7	291
ST108	1-1437383-8	291
ST112	1-1437383-9	291
SM11	2-1437683-7	206
SM2V02	1776227-1	101
SM8	2-1437683-8	205
SMC2402	1776226-1	101
SPDT	—	209
SSB3	—	115, 161, 162, 166, 168, 169, 170, 175, 176, 178.
SSB3FP	—	168
SSB3FP0202	—	162
SSB3FP020201	1-1437401-1	162
SSB3FP02020111	1-1437401-2	162
SSB3FP020202	1-1437401-3	162
SSB3FP020401	1-1437401-4	162
SSB3FP0302	—	162
SSB3FP030201	1-1437401-5	162
SSB3FP030202	1-1437401-6	162
SSB3FP030402	1-1437401-7	162
SSB3FP030702	1-1437401-8	162
SSB3FP03070211	1-1437401-9	162
SSB3FP0402	—	162
SSB3FP040201	2-1437401-0	162
SSB3FP040202	2-1437401-1	162
SSB3FP041202	2-1437401-2	162
SSB3FP0502	—	162
SSB3FP050201	2-1437401-3	162
SSB3FP05020117	2-1437401-4	162
SSB3FP050202	2-1437401-5	162
SSB3FP05020217	2-1437401-6	162
SSB3FP050202NN60	2-1437401-7	162
SSB3FP0602	—	162
SSB3FP060201	2-1437401-8	162
SSB3FP060202	2-1437401-9	162
SSB3FP06020211AA	—	116
SSB3FP060402	3-1437401-0	162
SSB3FP060702	3-1437401-1	162
SSB3FP0702	—	162
SSB3FP070202	3-1437401-2	162
SSB3FP0802	—	162
SSB3FP080201	3-1437401-3	162
SSB3FP080202	—	162
SSB3FP080202	3-1437401-4	162
SSB3FP08020211	3-1437401-5	162
SSB3FP080202NN60	3-1437401-6	162
SSB3FP080702	3-1437401-7	162
SSB3FP0902	—	162
SSB3FP090201	3-1437401-8	162
SSB3FP090202	3-1437401-9	162
SSB3FP1002	—	162
SSB3FP100201	4-1437401-0	162
SSB3FP100202	4-1437401-1	162
SSB3FP1102	—	162
SSB3FP110202NN60	4-1437401-3	162
SSB3FP110702	4-1437401-4	162

BUCHANAN Part Number	Tyco Part Number	Page Number
SSB3FP1202	—	162
SSB3FP120201	4-1437401-5	162
SSB3FP120202	4-1437401-6	162
SSB3FP1302	—	162
SSB3FP130201	4-1437401-7	162
SSB3FP130202	4-1437401-8	162
SSB3FP1402	—	162
SSB3FP140201	4-1437401-9	162
SSB3FP140202	5-1437401-0	162
SSB3FP150202	5-1437401-1	162
SSB3FP150401	5-1437401-2	162
SSB3FP160202	5-1437401-3	162
SSB3FP170202	5-1437401-4	162
SSB3FP180202	5-1437401-5	162
SSB3FP180402	5-1437401-6	162
SSB3FP190202	5-1437401-7	162
SSB3FP200202	5-1437401-8	162
SSB3FP210202	5-1437401-9	162
SSB3FP231202	6-1437401-0	162
SSB3FP240202	6-1437401-1	162
SSB3FP250202	6-1437401-2	162
SSB7CE04030	6-1437415-3	152
SSB7CE120302	8-796602-1	152
SSB7CE220303	1546561-5	152
SSB7CF030302	8-796602-6	152
SSB7CF030304	1-1546561-3	152
SSB7CF03035611	8-796602-8	152
SSB7CF040321	2-1546561-0	152
SSB7CF130300	6-1437415-4	152
SSB7CF25030229	3-1546561-3	152
SSB7CG020321	3-1546561-1	152
SSB7CG020326	6-1437415-5	152
SSB7CG030302	9-796602-6	152
SSB7CG030321	8-796602-9	152
SSB7CG03032311	2-1546561-7	152
SSB7CG030326	2-1546561-4	152
SSB7CG040326	2-1546561-5	152
SSB7CG050301	6-1437415-6	152
SSB7CG050304	6-1437415-7	152
SSB7CG05030411	6-1437415-8	152
SSB7CG050326	7-1437415-0	152
SSB7CG060302	7-1437415-2	152
SSB7CG060326	2-1546561-6	152
SSB7CG090301	7-1437415-3	152
SSB7CG090304	7-1437415-4	152
SSB7CG09032224	7-1437415-5	152
SSB7CG11030229	1-1546561-5	152
SSB7CG110329	1-1546561-6	152
SSB7CG140301	7-1437415-6	152
SSB7CG160304	7-1437415-7	152
SSB7FE020202	7-1437415-8	152
SSB7FE030501	7-1437415-9	152
SSB7FE060704	1-796602-7	152
SSB7FE140204	8-1437415-0	152
SSB7FE180501	8-1437415-1	152
SSB7FF020702	1546561-1	152
SSB7FF030101	8-1437415-2	152
SSB7FF040702	1546561-2	152
SSB7FF04070211	1-1546561-7	152
SSB7FF041503	8-1437415-3	152
SSB7FF101501	8-1437415-4	152
SSB7FF110102	8-796602-7	152
SSB7FF250104	2-796602-9	152
SSB7FG020209	8-1437415-5	152
SSB7FG030103	8-1437415-6	152
SSB7FG040102	9-796602-8	152
SSB7FG040104	7-796602-6	152
SSB7FG040702	9-796602-7	152
SSB7FG041502	1546561-7	152
SSB7FG050103	8-1437415-7	152
SSB7FG050202	8-1437415-8	152
SSB7FG050502	9-796602-3	152
SSB7FG060701	8-1437415-9	152
SSB7FG080201	9-1437415-0	152
SSB7FG090209	8-796602-2	152
SSB7FG100502	9-796602-5	152
SSB7FG150202	9-1437415-1	152
SSB7FG160201	9-1437415-2	152
SSB7FM030201	9-1437415-3	152
SSB7FM030202	9-1437415-4	152
SSB7FM060201	9-1437415-5	152
SSB7FM06020211	9-1437415-6	152
SSB7FM061504	796602-9	152
SSB7FM070602	9-1437415-7	152
SSB7FM081301	9-1437415-8	152
SSB7FM090201	1437416-1	152
SSB7FP020201	1437416-2	152
SSB7FP02020111	1437416-3	152
SSB7FP020202	1437416-4	152
SSB7FP020203	1437416-5	152
SSB7FP030201	1437416-6	152
SSB7FP030202	1437416-7	152
SSB7FP03020211	1546561-6	152
SSB7FP030203	1437416-9	152
SSB7FP040102	9-796602-0	152

BUCHANAN Part Number	Tyco Part Number	Page Number
SSB7FP04010211	9-796602-1	152
SSB7FP040200	1-1437416-0	152
SSB7FP040201	1-1437416-1	152
SSB7FP040202	1-1437416-2	152
SSB7FP040401	1-1437416-4	152
SSB7FP041602	8-796602-4	152
SSB7FP041602_23	8-796602-5	152
SSB7FP050201	1-1437416-5	152
SSB7FP05020111	1-1437416-6	152
SSB7FP050202	1-1437416-7	152
SSB7FP050203	1-1437416-8	152
SSB7FP050402	1-1437416-9	152
SSB7FP060200	2-1437416-0	152
SSB7FP060201	2-1437416-1	152
SSB7FP060202	2-1437416-2	152
SSB7FP06020211	—	152
SSB7FP060203	2-1437416-3	152
SSB7FP070201	2-1437416-4	152
SSB7FP07020111	2-1437416-5	152
SSB7FP070203	2-1437416-6	152
SSB7FP070402	8-796602-8	152
SSB7FP080101	2-1437416-7	152
SSB7FP080202	2-1437416-8	152
SSB7FP080203	2-1437416-9	152
SSB7FP080204	3-1437416-0	152
SSB7FP080401	3-1437416-1	152
SSB7FP090202	3-1437416-2	152
SSB7FP090203	1-1546561-9	152
SSB7FP090401	3-1437416-3	152
SSB7FP100201	3-1437416-4	152
SSB7FP100202	3-1437416-5	152
SSB7FP100203	3-1437416-6	152
SSB7FP100280	3-1437416-7	152
SSB7FP110200	3-1437416-8	152
SSB7FP110202	1-1546561-2	152
SSB7FP110203	3-1437416-9	152
SSB7FP120201	4-1437416-0	152
SSB7FP120203	4-1437416-1	152
SSB7FP130201	4-1437416-3	152
SSB7FP140102	4-1437416-4	152
SSB7FP140201	4-1437416-5	152
SSB7FP140203	1546561-4	152
SSB7FP150201	4-1437416-6	152
SSB7FP150202	4-1437416-7	152
SSB7FP150902	4-1437416-9	152
SSB7FP170202	5-1437416-0	152
SSB7FP18020212	5-1437416-1	152
SSB7FP200202	5-1437416-2	152
SSB7FP250202	5-1437416-3	152
SSB7FP260202	5-1437416-4	152
SSB7FP260203	1-1546561-8	152
SSB7FP270201	9-796602-2	152
SSB7RF030202	5-1437416-5	152
SSB7RF060202	5-1437416-6	152
SSB7RG080404	5-1437416-7	152
SSB7RM130202	5-1437416-8	152
SSB7RP020202	5-1437416-9	152
SSB7RP02020211	6-1437416-0	152
SSB7RP020209	2-1546561-2	152
SSB7RP030203	6-1437416-1	152
SSB7RP030204	6-1437416-2	152
SSB7RP030209	2-1546561-3	152
SSB7RP040201	6-1437416-3	152
SSB7RP04020211	6-1437416-4	152
SSB7RP040204	6-1437416-5	152
SSB7RP050202	6-1437416-6	152
SSB7RP060204	6-1437416-7	152
SSB7RP070202	3-1546561-4	152
SSB7RP080202	6-1437416-8	152
SSB7RP090202	6-1437416-9	152
SSB7RP120202	7-1437416-0	152
SSB7T9030402	7-1437416-1	152
SSB7TE020101	7-1437416-2	152
SSB7TE040101	2-1546561-0	152
SSB7TE040502	7-1437416-3	152
SSB7TE050722	7-1437416-4	152
SSB7TE060104	7-1437416-5	152
SSB7TE070101	7-1437416-6	152
SSB7TE070103	7-1437416-7	152
SSB7TE070104	7-1437416-8	152
SSB7TE160702	7-1437416-9	152
SSB7TE180501	8-1437416-0	152
SSB7TE180722	8-1437416-1	152
SSB7TF02042711	3-1546561-2	152
SSB7TF020502	8-1437416-2	152
SSB7TF03042711	2-1546561-9	152
SSB7TF030502	8-1437416-3	152
SSB7TF040502	8-1437416-4	152
SSB7TF050501	1-1546561-4	152
SSB7TF060102	8-	

Note: All part numbers are RoHS Compliant.

BUCHANAN Part Number	Tyco Part Number	Page Number
SSB7TF080502	8-1437416-9	152
SSB7TF140501	9-1437416-0	152
SSB7TF200501	9-1437416-1	152
SSB7TG010501	5-1437417-6	152
SSB7TG020501	1546561-8	152
SSB7TG020502	9-1437416-2	152
SSB7TG020503	9-1437416-3	152
SSB7TG030502	9-1437416-4	152
SSB7TG040101	9-1437416-5	152
SSB7TG040509	2-1546561-1	152
SSB7TG070101	9-1437416-6	152
SSB7TG080101	9-1437416-7	152
SSB7TG080502	9-1437416-8	152
SSB7TG100101	9-1437416-9	152
SSB7TG100501	1437417-1	152
SSB7TG110902	1-796602-4	152
SSB7TG120101	1546561-9	152
SSB7TG130902	2-796602-0	152
SSB7TG140101	1-796602-8	152
SSB7TG160101	1-1546561-0	152
SSB7TG180503	3-1546561-5	152
SSB7TG190501	1437417-3	152
SSB7TG200101	1-1546561-1	152
SSB7TG200401	1437417-4	152
SSB7TG250103	1-796602-9	152
SSB7TM020501	1437417-5	152
SSB7TM030502	8-796602-3	152
SSB7TM040101	1437417-6	152
SSB7TM050501	1546561-3	152
SSB7TM060101	1437417-7	152
SSB7TM060102	1437417-8	152
SSB7TM060104	796602-4	152
SSB7TM08010	1437417-9	152
SSB7TM160104	1-796602-1	152
SSB7TM200104	1-796602-2	152
SSB7TP030402	1-1437417-0	152
SSB7TP050101	1-1437417-1	152
SSB7TP060402	1-1437417-2	152
SSB7TP060701	1-1437417-3	152
SSB7TP070701	1-1437417-4	152
SSB7TP070703	1-1437417-5	152
SSB7TP090402	1-1437417-6	152
SSB7TP100401	1-1437417-7	152
SSB7TP100508	3-1546561-0	152
SSB7TP120501	1-1437417-8	152
SSB7TP120502	5-1437417-7	152
SSB7TP130701	1-1437417-9	152
SSB7TP150402	2-1437417-0	152
SSB7TP150701	2-1437417-1	152
SSB7TP160701	2-1437417-2	152
SSB7TP180102	2-1437417-3	152
ST80	1-1437403-1	128, 134, 153, 176, 194
TB1	3-1437683-0	205, 206, 212
TC2-02-AG	7-1437644-1	174
TC2-03-AG	7-1437644-2	174
TC2-05-AG	7-1437644-3	174
TC2-06-AG	7-1437644-4	174
TC2-08-AG	7-1437644-5	174
TC2-10-AG	7-1437644-6	174
TC2-13-AG	7-1437644-7	174
TC3-02-AG	7-1437644-8	174
TC3-03-AG	7-1437644-9	174
TC3-04-AG	8-1437644-0	174
TC3-06-AG	8-1437644-1	174
TC3-07-AG	8-1437644-2	174
TC3-08-AG	8-1437644-3	174
TC3-12-AG	8-1437644-4	174
TC3-20-AG	8-1437644-5	174
TC4-02-PF	1437661-8	174
TC4-02-PFH	1437661-9	174
TC4-03	1-1437645-9	174
TC4-03-PF	1-1437661-0	174
TC4-03-PFH	1-1437661-2	174
TC4-04-PF	1-1437661-3	174
TC4-04-PFH	1-1437661-4	174
TC4-05	1437645-8	174
TC4-05-PF	1-1437661-5	174
TC4-05-PFH	1-1437661-6	174
TC4-06	1-1437645-1	174
TC4-06-PF	1-1437661-7	174
TC4-06-PFH	1-1437661-8	174
TC4-06-PFH-CL	—	174
TC4-07-PF	1-1437661-9	174
TC4-07-PFH	2-1437661-0	174
TC4-08-PF	2-1437661-1	174
TC4-08-PFH	2-1437661-2	174
TC4-09-PF	6-1437661-7	174
TC4-09-PFH	2-1437661-3	174
TC4-10-PF	2-1437661-4	174
TC4-10-PFH	2-1437661-5	174
TC4-12-PFH	7-1437661-2	174
TC4-14	2-1437645-0	174
TC4-14-PFH	7-1437661-7	174
TC4-15-PFH	7-1437661-8	174
TC4-18	1-1437645-7	174

BUCHANAN Part Number	Tyco Part Number	Page Number
TC4-28	1-1437645-2	174
TC6-02-PFH	2-1437661-7	174
TC6-03	1-1437645-3	174
TC6-03-PF	2-1437661-8	174
TC6-03-PFH	2-1437661-9	174
TC6-04-PF	3-1437661-1	174
TC6-04-PFH	3-1437661-2	174
TC6-05	1-1437645-0	174
TC6-05-PF	3-1437661-3	174
TC6-05-PFH	3-1437661-4	174
TC6-06-PF	3-1437661-5	174
TC6-06-PFH	3-1437661-7	174
TC6-07-PF	6-1437661-9	174
TC6-07-PFH	3-1437661-8	174
TC6-08-PF	3-1437661-9	174
TC6-08-PFH	4-1437661-0	174
TC6-09-PF	7-1437661-0	174
TC6-09-PFH	4-1437661-2	174
TC6-10-PF	4-1437661-3	174
TC6-10-PFH	4-1437661-4	174
TC6-11-PFH	7-1437661-4	174
TC6-12-PFH	4-1437661-5	174
TC6-15-PFH	4-1437661-6	174
TC6-16-PFH	4-1437661-7	174
TC8-02-AG	1-1437645-4	174
TC8-02-PF	4-1437661-8	174
TC8-02-PFH	7-1437661-5	174
TC8-03-AG	1-1437645-5	174
TC8-03-PF	4-1437661-9	174
TC8-03-PFH	5-1437661-0	174
TC8-04-PF	5-1437661-1	174
TC8-04-PFH	5-1437661-2	174
TC8-05-AG	1437645-7	174
TC8-05-PF	5-1437661-3	174
TC8-05-PFH	5-1437661-4	174
TC8-06-AG	1-1437645-6	174
TC8-06-PF	5-1437661-5	174
TC8-06-PFH	5-1437661-6	174
TC8-07-PF	5-1437661-7	174
TC8-07-PFH	5-1437661-8	174
TC8-08-PF	5-1437661-9	174
TC8-08-PFH	6-1437661-0	174
TC8-09-AG	9-1437644-0	174
TC8-09-PF	7-1437661-6	174
TC8-09-PFH	7-1437661-9	174
TC8-10-PF	6-1437661-1	174
TC8-10-PFH	6-1437661-2	174
TC8-11-PFH	6-1437661-3	174
TC9-02-AG	9-1437644-2	174
TC9-03-AG	9-1437644-3	174
TC9-04-AG	9-1437644-4	174
TC9-05-AG	9-1437644-5	174
TC9-06-AG	9-1437644-8	174
TC9-07-AG	9-1437644-9	174
TC9-08-AG	1437645-1	174
TC9-09-AG	1437645-2	174
TC9-11-AG	2-1437645-1	174
TC9-14-AG	1437645-4	174
TC9-18-AG	1437645-5	174
TK2-24-AG	6-1437685-9	211
TK2-2-AG	6-1437685-8	211
TK2-3-AG	7-1437685-0	211
TK2-48-AG	7-1437685-6	211
TK2-4-AG	7-1437685-3	211
TK2-6-AG	8-1437685-3	211
TK2D-12	8-1437685-8	211
TK2D-48	9-1437685-1	211
TK2D-6	9-1437685-2	211
TKAD	6-1437661-4	211
TR-1	1437645-6	212
TSB1000	—	235, 237
TSB100001	1776301-1	227
TSB100001DS	1776302-1	226
TSB100001DSHT	1776304-1	228
TSB100002	1776303-2	227
TSB100002DS	1776302-2	226
TSB100002DSHT	1776304-2	228
TSB100003	1776303-3	227
TSB100003DS	1776302-3	226
TSB100003DSHT	1776304-3	228
TSB100004	1776303-4	227
TSB100004DS	1776302-4	226
TSB100004DSHT	1776304-4	228
TSB100005	1776303-5	227
TSB100005DS	1776302-5	226
TSB100005DSHT	1776304-5	228
TSB100006	1776303-6	227
TSB100006DS	1776302-6	226
TSB100006DSHT	1776304-6	228
TSB100007	1776303-7	227
TSB100007DS	1776302-7	226
TSB100007DSHT	1776304-7	228
TSB100008	1776303-8	227
TSB100008DS	1776302-8	226
TSB100008DSHT	1776304-8	228

BUCHANAN Part Number	Tyco Part Number	Page Number
TSB100009	1776303-9	227
TSB100009DS	1776302-9	226
TSB100009DSHT	1776304-9	228
TSB100010	1-1776303-0	227
TSB100010DS	1-1776302-0	226
TSB100010DSHT	1-1776304-0	228
TSB100011	1-1776303-1	227
TSB100011DS	1-1776302-1	226
TSB100011DSHT	1-1776304-1	228
TSB100012	1-1776303-2	227
TSB100012DS	1-1776302-2	226
TSB100012DSHT	1-1776304-2	228
TSB1500	—	215, 235, 237
TSB150001	1776310-1	230
TSB150001DS	1776311-1	230
TSB150002	1776310-2	230
TSB150002DS	1776311-2	230
TSB150003	1776310-3	230
TSB150003DS	1776311-3	230
TSB150004	1776310-4	230
TSB150004DS	1776311-4	230
TSB150005	1776310-5	230
TSB150005DS	1776311-5	230
TSB150006	1776310-6	230
TSB150006DS	1776311-6	230
TSB150007	1776310-7	230
TSB150007DS	1776311-7	230
TSB150008	1776310-8	230
TSB150008DS	1776311-8	230
TSB150009	1776310-9	230
TSB150009DS	1776311-9	230
TSB150010	1-1776310-0	230
TSB150010DS	1-1776311-0	230
TSB150011	1-1776310-1	230
TSB150011DS	1-1776311-1	230
TSB150012	1-1776310-2	230
TSB150012DS	1-1776311-2	230
TSB2000	—	215, 237
TSB200001	1776312-1	231
TSB200001DS	1776313-1	231
TSB200001DSHT	1776314-1	232
TSB200001KDS	—	233
TSB200002	1776312-2	231
TSB200002DS	1776313-2	231
TSB200002DSHT	1776314-2	232
TSB200002KDS	1776315-2	233
TSB200003	1776312-3	231
TSB200003DS	1776313-3	231
TSB200003DSHT	1776314-3	232
TSB200003KDS	1776315-3	233
TSB200004	1776312-4	231
TSB200004DS	1776313-4	231
TSB200004DSHT	1776314-4	232
TSB200004KDS	1776315-4	233
TSB200005	1776312-5	231
TSB200005DS	1776313-5	231
TSB200005DSHT	1776314-5	232
TSB200005KDS	1776315-5	233
TSB200006	1776312-6	231
TSB200006DS	1776313-6	231
TSB200006DSHT	1776314-6	232
TSB200006KDS	1776315-6	233
TSB200007	1776312-7	231
TSB200007DS	1776313-7	231
TSB200007DSHT	1776314-7	232
TSB200007KDS	1776315-7	233
TSB200008	1776312-8	231
TSB200008DS	1776313-8	231
TSB200008DSHT	1776314-8	232
TSB200008KDS	1776315-8	233
TSB200009	1776312-9	231
TSB200009DS	1776313-9	231
TSB200009DSHT	1776314-9	232
TSB200009KDS	1776315-9	233
TSB200010	1-1776312-0	231
TSB200010DS	1-1776313-0	231
TSB200010DSHT	1-1776314-0	232
TSB200010KDS	1-1776315-0	233
TSB200011	1-1776312-1	231
TSB200011DS	1-1776313-1	231
TSB200011DSHT	1-1776314-1	232
TSB200011KDS	1-1776315-1	233
TSB200012	1-1776312-2	231
TSB200012DS	1-1776313-2	231
TSB200012DSHT	1-1776314-2	232
TSB200012KDS	1-1776315-2	233
TSB230	—	214, 237
TSB23001	1776294-1	219
TSB23001DS	1776293-1	218
TSB23001DSHT	1776295-1	220
TSB23002	1776294-2	216, 219
TSB23002DS	1776293-2	218
TSB23002DSHT	1776295-2	220
TSB23003	1776294-3	219
TSB23003DS	1776293-3	218

Note: All part numbers are RoHS Compliant.

BUCHANAN Part Number	Tyco Part Number	Page Number
TSB23003DSHT	1776295-3	220
TSB23004	1776294-4	219
TSB23004DS	1776293-4	218
TSB23004DSHT	1776295-4	220
TSB23005DS	1776293-5	218
TSB23005DSHT	1776295-5	220
TSB23006	1776294-6	219
TSB23006DS	1776293-6	218
TSB23006DSHT	1776295-6	220
TSB23007	1776294-7	219
TSB23007DS	1776293-7	218
TSB23007DSHT	1776295-7	220
TSB23008	1776294-8	219
TSB23008DS	1776293-8	218
TSB23008DSHT	1776295-8	220
TSB23009	1776294-9	219
TSB23009DS	1776293-9	218
TSB23009DSHT	1776295-9	220
TSB23010	1-1776294-0	219
TSB23010DS	1-1776293-0	218
TSB23010DSHT	1-1776295-0	220
TSB23011	1-1776294-1	219
TSB23011DS	1-1776293-1	218
TSB23011DSHT	1-1776295-1	220
TSB23012	1-1776294-2	219
TSB23012DS	1-1776293-2	218
TSB23012DSHT	1-1776295-2	220
TSB500	—	214, 216, 221, 222, 223, 225, 234, 235, 236, 237, 293
TSB5000131	1776297-1	222
TSB5000131DS	1776296-1	221
TSB5000131DSHT	1776298-1	223
TSB5000231	1776297-2	222
TSB5000231DS	1776296-2	221
TSB5000231DSHT	1776298-2	223
TSB5000331	1776297-3	222
TSB5000331DS	1776296-3	221
TSB5000331DSHT	1776298-3	223
TSB5000431	1776297-4	222
TSB5000431DS	1776296-4	221
TSB5000431DSHT	1776298-4	223
TSB5000531	1776297-5	222
TSB5000531DS	1776296-5	221
TSB5000531DSHT	1776298-5	223
TSB5000631	1776297-6	222
TSB5000631DS	1776296-6	221
TSB5000631DSHT	1776298-6	223
TSB5000731	1776297-7	222
TSB5000731DS	1776296-7	221
TSB5000731DSHT	1776298-7	223
TSB5000831	1776297-8	222
TSB5000831DS	1776296-8	221
TSB5000831DSHT	1776298-8	223
TSB5000931	1776297-9	222
TSB5000931DS	1776296-9	221
TSB5000931DSHT	1776298-9	223
TSB5001031	1-1776297-0	222
TSB5001031DS	1-1776296-0	221
TSB5001031DSHT	1-1776298-0	223
TSB5001131	1-1776297-1	222
TSB5001131DS	1-1776296-1	221
TSB5001131DSHT	1-1776298-1	223
TSB5001231	1-1776297-2	222
TSB5001231DS	1-1776296-2	221
TSB5001231DSHT	1-1776298-2	223
TSB500SK	—	214, 235
TSB500SK01	1776299-1	224
TSB500SK01MDS	1776300-1	224
TSB500SK02	1776299-2	224
TSB500SK02MDS	1776300-2	224
TSB500SK03	1776299-3	224
TSB500SK03MDS	1776300-3	224
TSB500SK04	1776299-4	224
TSB500SK04MDS	1776300-4	224
TSB500SK05	1776299-5	224
TSB500SK05MDS	1776300-5	224
TSB500SK06	1776299-6	224
TSB500SK06MDS	1776300-6	224
TSB500SK07	1776299-7	224
TSB500SK07MDS	1776300-7	224
TSB500SK08	1776299-8	224
TSB500SK08MDS	1776300-8	224
TSB500SK09	1776299-9	224
TSB500SK09MDS	1776300-9	224
TSB500SK10	1-1776299-0	224
TSB500SK10MDS	1-1776300-0	224
TSB500SK11	1-1776299-1	224
TSB500SK11MDS	1-1776300-1	224
TSB500SK12	1-1776299-2	224
TSB500SK12MDS	1-1776300-2	224
USB3B02S	5-1437404-3	162
USB3B03S	5-1437404-4	162
USB3B04S	5-1437404-5	162
USB3B05S	5-1437404-6	162
USB3B06S	5-1437404-7	162

BUCHANAN Part Number	Tyco Part Number	Page Number
USB3B07S	5-1437404-8	162
USB3B08S	5-1437404-9	162
USB3B09S	6-1437404-0	162
USB3B10S	6-1437404-1	162
USB3B11S	6-1437404-2	162
USB3B12S	6-1437404-3	162
USB3B13S	796632-1	162
USB3B14S	6-1437404-4	162
USB3FP0202	—	162
USB3FP0302	—	162
USB3FP0402	—	162
USB3FP0502	—	162
USB3FP0602	—	162
USB3FP0702	—	162
USB3FP0802	—	162
USB3FP0902	—	162
USB3FP1002	—	162
USB3FP1102	—	162
USB3FP1202	—	162
USB3FP1302	—	162
USB3FP1402	—	162
USB3VP0212	—	162
USB3VP0312	—	162
USB3VP0412	—	162
USB3VP0512	—	162
USB3VP0612	—	162
USB3VP0712	—	162
USB3VP0812	—	162
USB3VP0912	—	162
USB3VP1012	—	162
USB3VP1112	—	162
USB3VP1212	—	162
USB3VP1312	—	162
USB3VP1412	—	162

BUCHANAN Part Number	Tyco Part Number	Page Number
----------------------	------------------	-------------

Note: All part numbers
are RoHS Compliant.

Engineering Notes

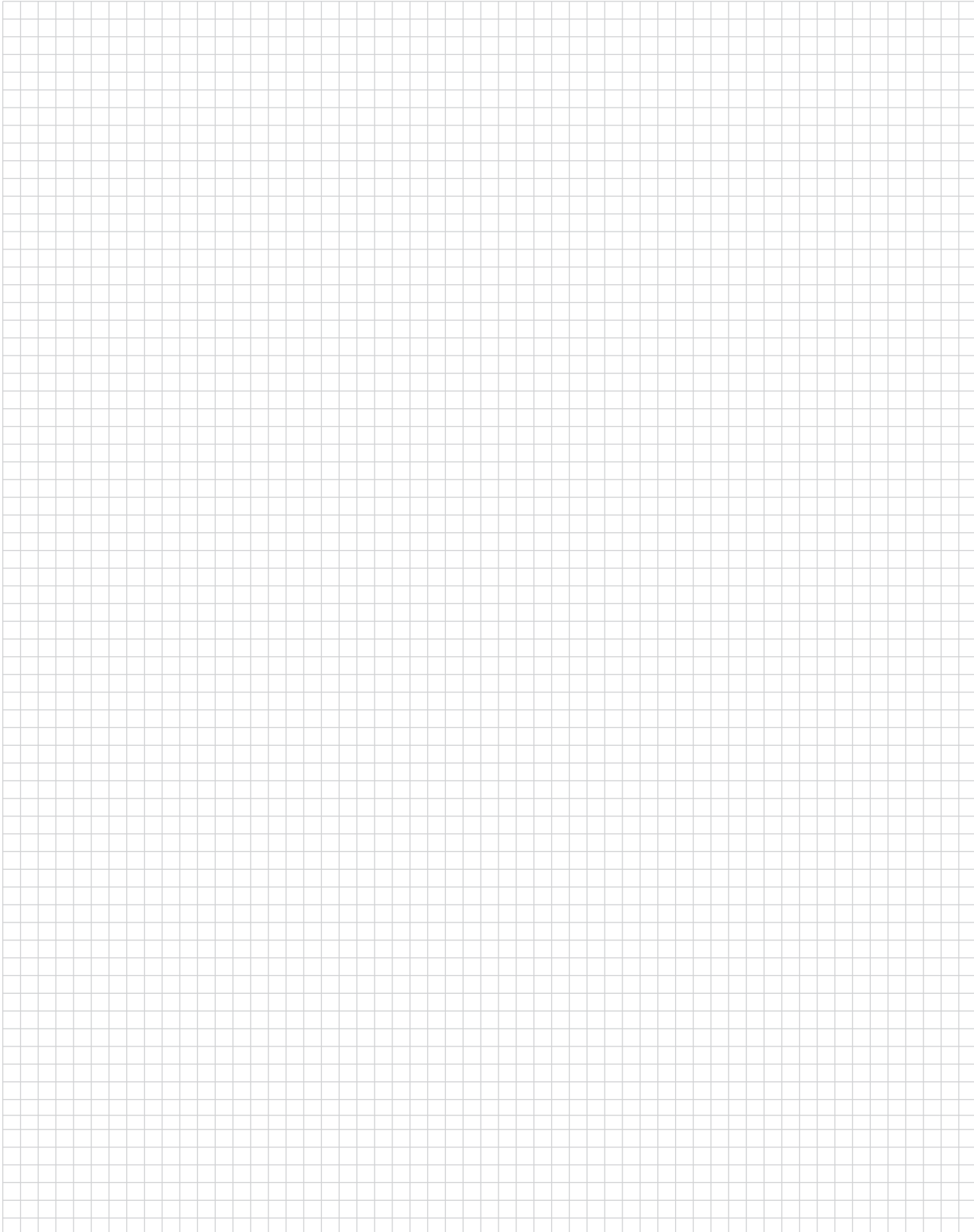

Appendix — Recommended Screw Tightening Torque

Centerline Spacing Reference

Pitch (Centerline spacing)	Product	Page	Max. Tightening Torque inch-pounds
2.5 [0.984"]	SMC Surface Mount, screwless	101	n/a
5.00 [1.97"]	B51C4 Eurostyle, Two-Piece	89	4.4
5.08 [.200"]	2SV Eurostyle, screwless	104	n/a
	B51C8 Eurostyle, Two-Piece	91	4.4
6.35 [.250"]	#3 Tri-Barrier	119-138	5.5
	1546657 Dual Barrier	141, 142	9
	4DB Dual-Barrier	143, 144	7
	#4 Tri-Barrier	124-127	7
8.26 [.325"]	RSB3 Tri-Barrier	164-166	9
	SSB3 Dual Barrier	168-170	9
	1546927 With Attached Cover	127	12
	1546734 High Rise Dual Barrier	145, 146	10
	#6 Tri-Barrier	128-135	7
9.53 [.375"]	BC6 Tri-Barrier	133-134	7
	JC6 Dual Barrier	147, 148	7
	MB6 Bi-Level Tri-Barrier	135	7
	NC6 Low-Profile Dual Barrier	149, 150	7
	RSB6 Tri-Barrier	171-173	9
	11.11 [.4375"]	#8 Tri-Barrier	136-138
SSB7 Dual Barrier		151-154	8

Americas

Argentina – Buenos Aires
 Phone: +54-11-4733-2200
 Fax: +54-11-4733-2211

Brasil – São Paulo
 Phone: +55-11-3611-1311
 Fax: +55-11-3611-0397

Canada – Toronto
 Phone: +905-475-6222
 Fax: +905-474-5520
**Product Information Center:
 (Technical Support)**
 Phone: +905-470-4425
 Fax: +905-474-5525

Colombia – Bogota
 Phone: +57-1-231-9398
 Fax: +57-1-660-0206

Mexico – Mexico City
 Phone: +52-55-1106-0800
 +01-800-733-8926
 Fax: +52-55-1106-0901

United States – Harrisburg, PA
 Phone: +717-564-0100
 Fax: +717-986-7575
**Product Information Center:
 (Technical Support)**
 Phone: +800-522-6752
 Fax: +717-986-7575

**For Latin/South American
 Countries not shown**
 Phone: +54-11-4733-2015
 Fax: +54-11-4733-2083

Asia/Pacific

Australia – Sydney
 Phone: +61-2-9554-2600
 Fax: +61-2-9502-2556

**Product Information Center:
 (Technical Support)**
 Phone: +61-2-9840-8200
 Fax: +61-2-9634-6188

India – Bangalore
 Phone: +91-80-285-40800
 Fax: +91-80-285-40820

Indonesia – Jakarta
 Phone: +65-6482-0311
 Fax: +65-6482-1012

Japan – Toyko
 Phone: +81-44-844-8111
 Fax: +81-44-812-3207
Raychem & Identification Products
 Phone: +81-44-844-8183
 Fax: +81-44-844-8184
**Product Information Center:
 (Technical Support)**
 Phone: +81-44-844-8013
 Fax: +81-44-812-3200

Korea – Seoul
 Phone: +82-2-3415-4500
 Fax: +82-2-3486-3810

Malaysia – Kuala Lumpur
 Phone: +60-3-78053055
 Fax: +60-3-78053066

New Zealand – Auckland
 Phone: +64-9-634-4580
 Fax: +64-9-634-4586

Philippines – Makati City
 Phone: +632-848-0171
 Fax: +632-867-8661

People's Republic of China
 Hong Kong
 Phone: +852-2735-1628
 Fax: +852-2735-0243

Shanghai
 Phone: +86-21-2407-1588
 Fax: +86-21-2407-1599

Taiwan – Taipei
 Phone: +886-2-8768-2788
 Fax: +886-2-8768-2268

Singapore – Singapore
 Phone: +65-6482-0311
 Fax: +65-6482-1012

Raychem Products
 Phone: +65-4866-151
 Fax: +65-6545-514
Identification Products
 Phone: +65 (0) 6482-0311
 Fax: +65 (0) 6481-5514

Thailand – Bangkok
 Phone: +66-2-955-0500
 Fax: +66-2-955-0505

Vietnam and Indochina –
 Ho Chi Minh City
 Phone: +84-8 930-5546
 Fax: +84-8 930-3443

Europe/Middle East/Africa

Austria – Vienna
 Phone: +43-1 90 5 60-0
 Fax: +43-1 90 5 60-1333

Belgium – Kessel-Lo
 Phone: +32-16-35-23-00
 Fax: +32-16-35-23-52

Bulgaria – Sofia
 Phone: +359-2-971-2152
 Fax: +359-2-971-2153

Czech Republic – Kurim
 Phone: +420-5-41-162-111
 Fax: +420-5-41-162-223

Denmark – Glostrup
 Phone: +45-43-480-452
 Fax: +45-43-441-414

Egypt – Cairo
 Phone: +20-2-29 04 281
 Fax: +20-2-41 92 334

Estonia – Tartu
 Phone: +372-5138-274
 Fax: +372-7400-779

Finland – Helsinki
 Phone: +358-95-12-34-20
 Fax: +358-95-12-34-250

France – Cergy-Pontoise
 Phone: +33-1-3420-8888
 Fax: +33-1-3420-8600
**Product Information Center:
 (Technical Support)**
 Phone: +33-1-3420-8943
 Fax: +33-1-3420-8623

Germany – Bensheim
 Phone: +49-6251-133-0
 Fax: +49-6251-133-1600
**Product Information Center:
 (Technical Support)**
 Phone: +49-6251-133-1999
 Fax: +49-6251-133-1988

Germany – Langen
 Phone: +49-6103-709-0
 Fax: +49-6103-709-1223

Germany – Speyer
 Phone: +49-6232-30-0
 Fax: +49-6232-30-2243

Germany - HTS Division – Neunkirchen
 Phone: +49-2247-305-0
 Fax: +49-2247-305-122

Greece – Athens
 Phone: +30-210-9370-396/397
 Fax: +30-210-9370-655

Hungary – Budapest
 Phone: +36-1-289-1000
 Fax: +36-1-289-1010

Ireland – Dublin
 Phone: +353-1-820-3000
 Fax: +353-1-820-9790

Israel – Yokneam
 Phone: +972-4-959-0508
 Fax: +972-4-959-0506

Italy – Collegno (Torino)
 Phone: +39-011-4012-111
 Fax: +39-011-4031116

Lithuania – Vilnius
 Phone: +370-5-2131-402
 Fax: +370-5-2131-403

Netherlands – 's-Hertogenbosch
 Phone: +31-73-624-62-46
 Fax: +31-73-621-23-65
**Product Information Center:
 (Technical Support)**
 Phone: +31-73-6246-999
 Fax: +31-73-6246-998

Norway – Nesbru
 Phone: +47-66-77-8886
 Fax: +47-66-77-8855

Poland – Warsaw
 Phone: +48-22-45-76-700
 Fax: +48-22-45-76-720

Romania – Bucharest
 Phone: +40-21-311-3479/3596
 Fax: +40-21-312-0574

Russia – Moscow
 Phone: +7-495-926-5506/07/08/09
 Fax: +7-495-926-5505

Russia – St. Petersburg
 Phone: +7-812-718-8192
 Fax: +7-812-718-8193

Slovenia – Ljubljana
 Phone: +386-1561-3270
 Fax: +386-1561-3240

South Africa – Port Elizabeth
 Phone: +2741-503-4500
 Fax: +2741-581-0440

Spain – Barcelona
 Phone: +34-93-291-0330
 Fax: +34-93-201-7879

**Product Information Center:
 (Technical Support):**
 Phone: +34-93-291-0330
 Fax: +34-93-200-3779

Sweden – Upplands Väsby
 Phone: +46-8-50-72-50-00
 Fax: +46-8-50-72-50-01

Switzerland – Steinach
 Phone: +41-71-447-0447
 Fax: +41-71-447-0444

Turkey – Istanbul
 Phone: +90-212-281-8181/2/3
 Fax: +90-212-281-8184

Ukraine – Kiev
 Phone: +380-044-206-2265
 Fax: +380-044-206-2264

United Kingdom – Swindon
 Phone: +44-8706-080-208
 Fax: +44-1793-572-109
**Product Information Center:
 (Technical Support)**
 Freephone GB: 0900-267-666
 Phone: +44-208-420-8341 or 8343
 +44-208-420-8081

**United Kingdom – Raychem &
 Identification Products**
 Phone: +44-1793-528171
 Fax: +44-1793-572-516

**For Middle East/African Countries Not
 Shown**
 Phone: +33-1-3420-8866
 Fax: +33-1-3420-8300