

DATA SHEET

SKY65404-31: 5 GHz Low-Noise Amplifier

Applications

- 802.11a/n/ac radios
- 5 GHz ISM radios
- Smartphones
- Notebooks, netbooks, and tablets
- Access points, routers, and gateways
- Wireless video systems

Features

- Ultra-low noise figure: 1.0 dB
- 4.9 GHz to 5.9 GHz operation
- Enable/disable mode
- High IIP3: +7 dBm
- High gain: 13 dB
- 2.8 to 5.0 V single-supply operation
- QFN (6-pin, 1.5 x 1.5 mm) package (MSL1, 260 °C per JEDEC J-STD-020)



Skyworks Green™ products are compliant with all applicable legislation and are halogen-free. For additional information, refer to *Skyworks Definition of Green™*, document number SQ04-0074.

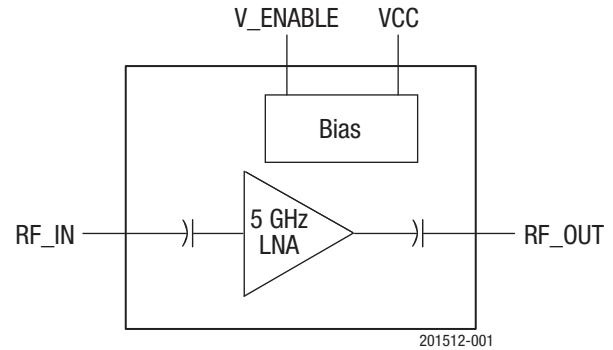

Figure 1. SKY65404-31 LNA Block Diagram

Description

The SKY65404-31 is an ultra-low-noise amplifier (LNA) intended for 5 GHz wireless receiver applications. Its industry-leading noise figure (NF), together with high linearity, makes it ideal as a first-stage LNA in 802.11a wireless local area network (WLAN) radios.

Operating with a single supply voltage, the SKY65404-31 consumes only 10 mA of current. The device includes a shutdown mode to save power when the receiver is inactive.

The tiny package footprint of the SKY65404-31, requiring only four external components, enables the industry's smallest PCB area needed to implement a 5 GHz LNA.

A block diagram of the SKY65404-31 is shown in Figure 1. The device package and pinout for the 6-pin Quad Flat No-Lead (QFN) are shown in Figure 2. Signal pin assignments and functional pin descriptions are described in Table 1.

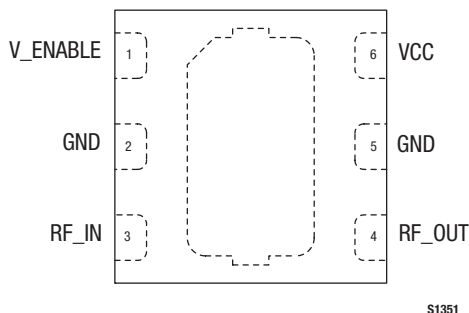

S1351

Figure 2. SKY65404-31 Pinout (Top View)

Table 1. SKY65404-31 Pin Assignments and Signal Descriptions

Pin	Name	Description	Pin	Name	Description
1	V_ENABLE	Enable control input	4	RF_OUT	LNA output
2	GND	Ground	5	GND	Ground
3	RF_IN	LNA input	6	VCC	Supply voltage for LNA

Technical Description

The SKY65404-31 is matched at the RF output port (pin 4) and requires only a shunt capacitor match at the RF input port (pin 3). The VCC signal (pin 6) requires a simple bypass circuit. An external resistor on the V_ENABLE signal (pin 1) allows a wide range of control voltages to be used. Shutdown mode is achieved by switching the V_ENABLE signal to 0 V.

Electrical and Mechanical Specifications

The absolute maximum ratings of the SKY65404-31 are provided in Table 2. The recommended operating conditions are specified in Table 3 and electrical specifications are provided in Table 4. Table 5 provides the control logic for the SKY65404-31.

Performance characteristics for the SKY65404-31 are illustrated in Figures 3 through 9.

Table 2. Absolute Maximum Ratings¹

Parameter	Symbol	Minimum	Maximum	Units
Supply voltage	VCC	0	5.5	V
DC voltage at control ports	VENABLE	0	5.0	V
RF input power: LNA enabled LNA disabled	RF _{IN}		+1 +10	dBm dBm
Operating temperature	T _A	-40	+85	°C
Storage temperature	T _{STG}	-40	+125	°C
Electrostatic discharge: Charged Device Model (CDM), Class 3 Human Body Model (HBM), Class 0 Machine Model (MM), Class A			500 150 50	V V V

¹ Exposure to maximum rating conditions for extended periods may reduce device reliability. There is no damage to device with only one parameter set at the limit and all other parameters set at or below their nominal values. Exceeding any of the limits listed here may result in permanent damage to the device.

ESD HANDLING: *Although this device is designed to be as robust as possible, electrostatic discharge (ESD) can damage this device. This device must be protected at all times from ESD when handling or transporting. Static charges may easily produce potentials of several kilovolts on the human body or equipment, which can discharge without detection. Industry-standard ESD handling precautions should be used at all times.*

Table 3. Recommended Operating Conditions (@ +25 °C, VCC = 3 V)

Parameter	Symbol	Min	Typ	Max	Units
Supply voltage	VCC	2.8	3.0	5.0	V
RF frequency range	f	4900		5900	MHz
Operating temperature range	T _A	-40	+25	+85	°C
DC voltage at control port: High Low	V _{ENABLE_H} V _{ENABLE_L}	2.5 0	3.0 0	3.5 0.2	V V

Table 4. Electrical Characteristics (4900 to 5900 MHz)¹
(VCC = 3 V, TA = +25 °C, V_ENABLE = 3 V, Unless Otherwise Noted)

Parameter	Symbol	Test Conditions	Min	Typ	Max	Units
Enable Mode						
Gain	S21		11	13	16	dB
Noise figure	NF		0.8	1.0	1.5	dB
Third order input intercept point	IIP3		+5	+7	+9	dBm
In-band 1 dB compression point at input	IP1dB		-5	-4	-2	dBm
Out-of-band (2.45 GHz injected signal) 1 dB compression point at input	IP1dB		-7	-3	-2	dBm
Input/output return loss	S11, S22	Zs/L = 50 Ω		-10	-6	dB
Reverse isolation	S12			-26	-20	dB
Drain current		V_ENABLE = 3 V V_ENABLE = 0 V	10 0	11 <1	15 5	mA μA
V_ENABLE current	IEN_HIGH	V_ENABLE = 3 V		2.3	3.0	mA
Rise time	tRISE			125	155	ns
Fall time	tFALL			60	90	ns
Disable Mode						
Gain	S21		-25		-15	dB
Input return loss	S11		-2	-1	0	dB
Output return loss	S22		-15	-12	-8	dB
V_ENABLE current	IEN_LOW	V_ENABLE = 0 V to 0.2 V		1.7	1.9	μA

¹ Performance is guaranteed only under the conditions listed in this table.

Table 5. Mode Control Logic

V_ENABLE Voltage (V)	Description
3	LNA is enabled
0	LNA is disabled

Typical Performance Characteristics
 (VCC = 3 V, Ta = +25 °C, V_ENABLE = 3 V, Unless Otherwise Noted)

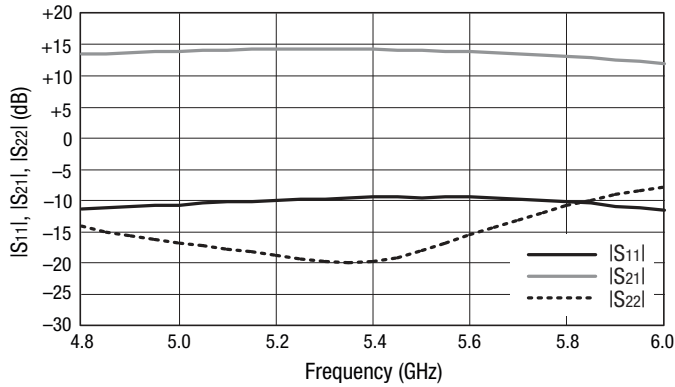

Figure 3. S-Parameter Data

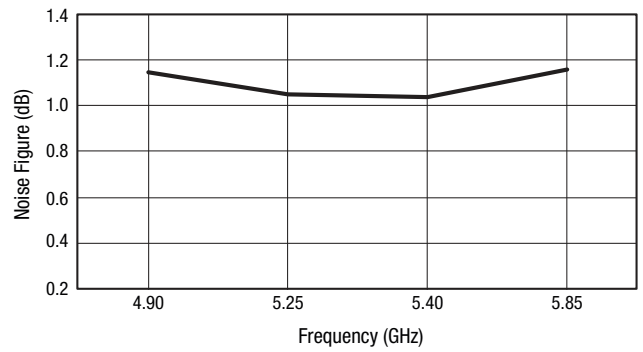

Figure 4. Noise Figure vs Frequency

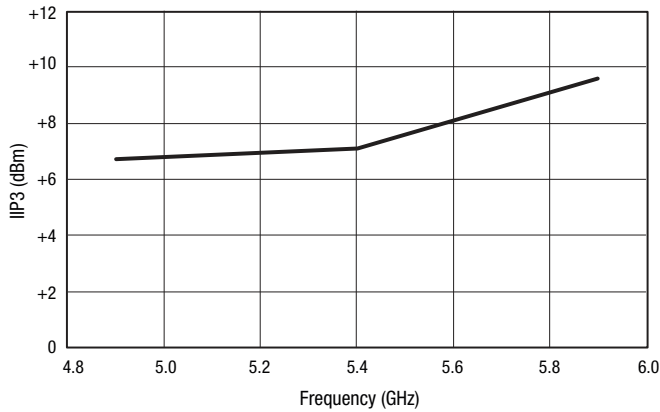

Figure 5. IIP3 vs Frequency

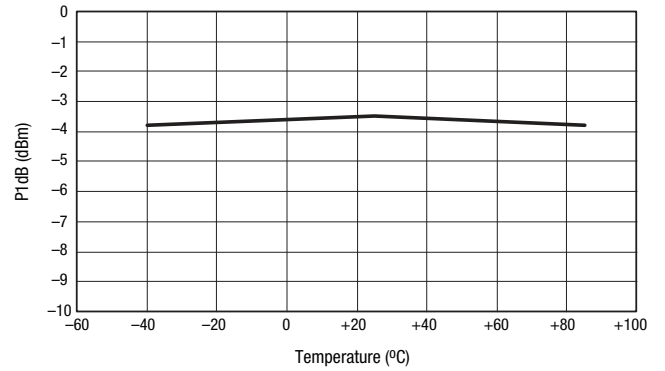

Figure 6. P1dB vs Temperature

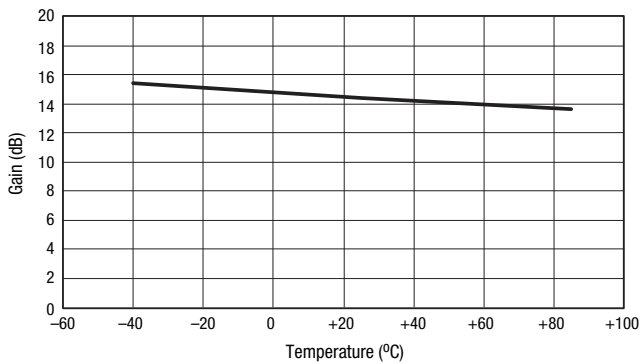

Figure 7. Gain vs Temperature

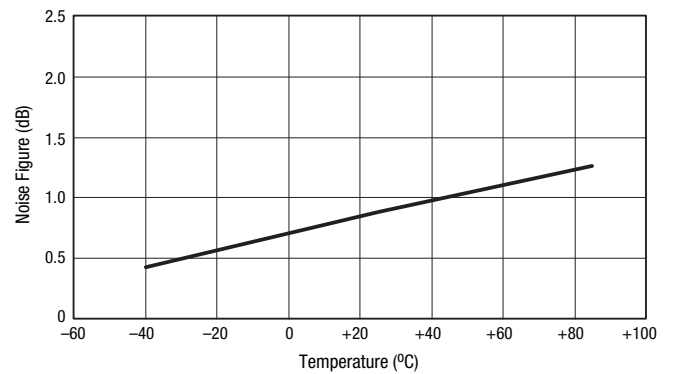

Figure 8. Noise Figure vs Temperature

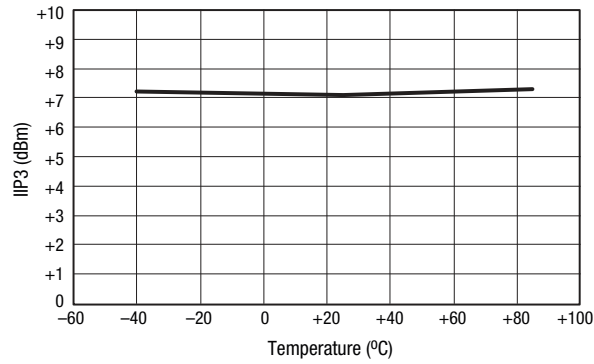

Figure 9. IIP3 vs Temperature

Evaluation Board Description

The SKY65404-31-11 Evaluation Board is used to test the performance of the SKY65404-31-11 LNA. A schematic diagram for the SKY65404-31 is shown in Figure 10.

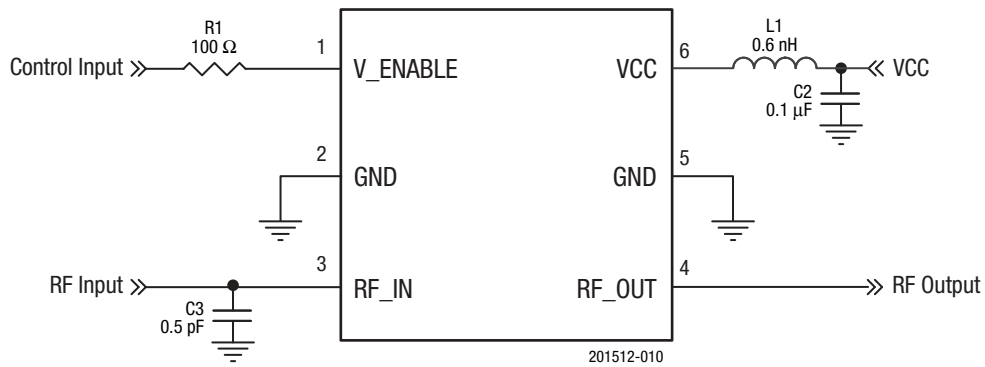

Figure 10. SKY65404-31 Schematic Diagram

Package Dimensions

The PCB footprint drawing for the SKY65404-31 is provided in Figure 11. Typical part markings are shown in Figure 12. The package dimensions are shown in Figure 13, and the tape and reel dimensions are provided in Figure 14.

Package and Handling Information

Instructions on the shipping container label regarding exposure to moisture after the container seal is broken must be followed. Otherwise, problems related to moisture absorption may occur when the part is subjected to high temperature during solder assembly.

The SKY65404-31 is rated to Moisture Sensitivity Level 1 (MSL1) at 260 °C. It can be used for lead or lead-free soldering. For additional information, refer to the Skyworks Application Note, *Solder Reflow Information*, document number 200164. Care must be taken when attaching this product, whether it is done manually or in a production solder reflow environment. Production quantities of this product are shipped in a standard tape and reel format.

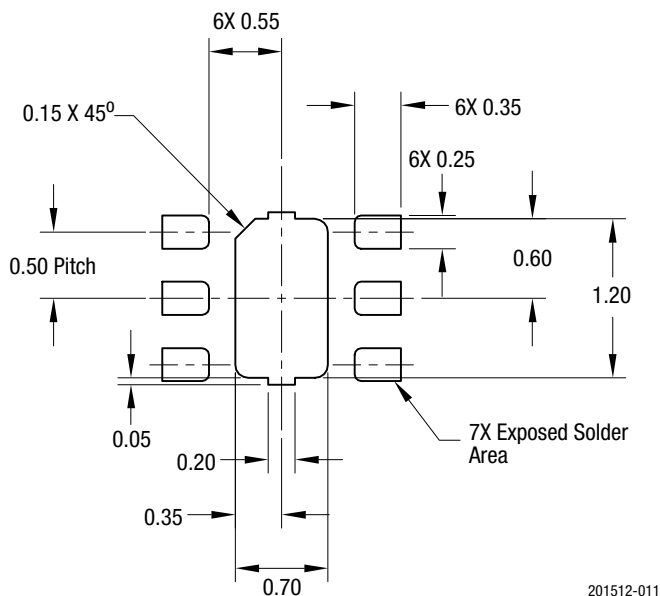

Figure 11. SKY65404-31 PCB Layout Footprint (Top View)

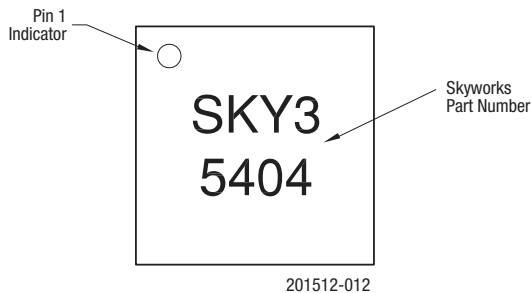
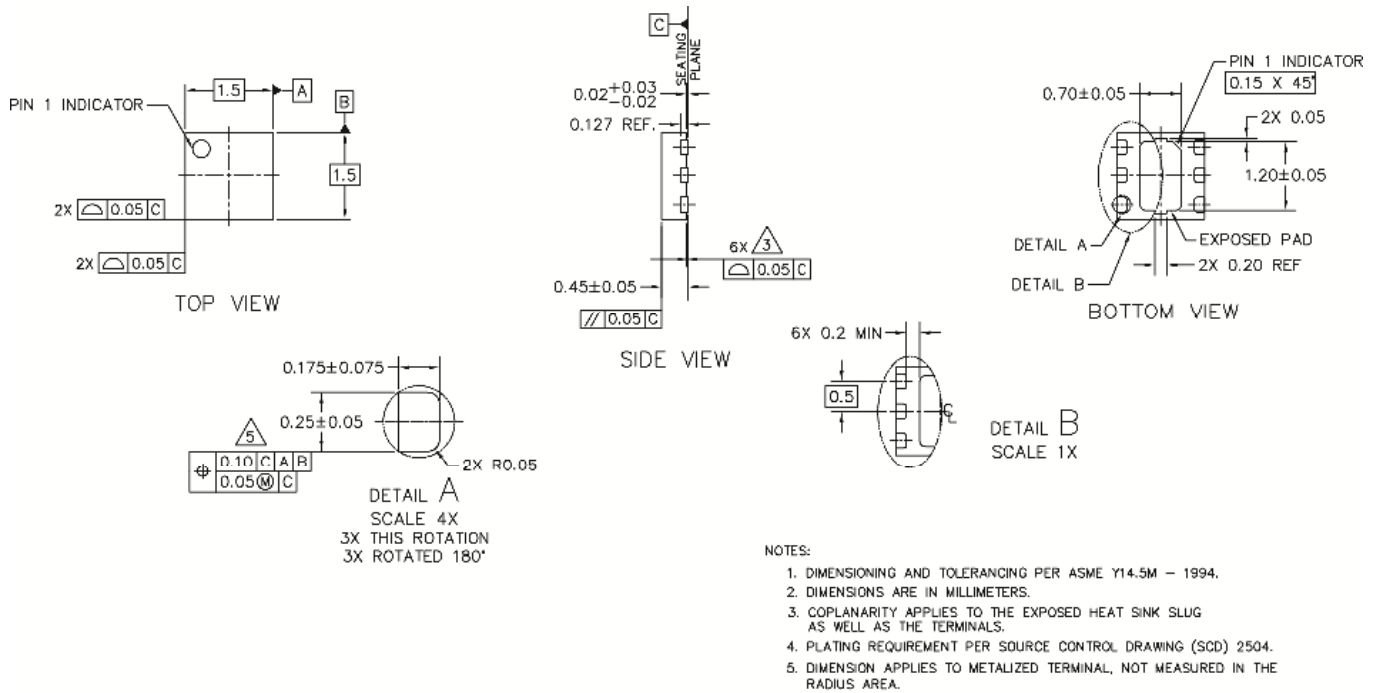
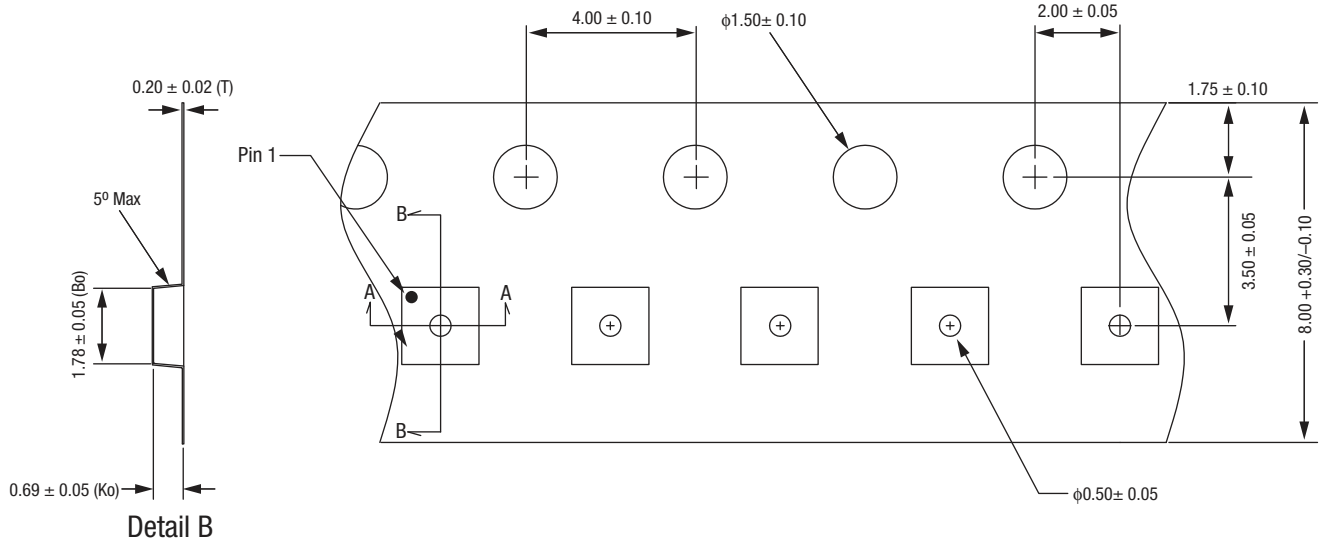

Figure 12. Typical Part Markings (Top View)



201512-013

Figure 13. SKY65404-31 Package Dimensions



Notes:

1. Carrier tape: black conductive polycarbonate or polystyrene.
2. Cover tape material: transparent conductive PSA.
3. Cover tape size: 5.4 mm width.
4. All measurements are in millimeters.

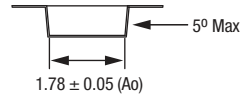

Detail A

201512-014

Figure 14. SKY65404-31 Tape and Reel Dimensions

Ordering Information

Product Description	Product Part Number	Evaluation Board Part Number
SKY65404-31 LNA	SKY65404-31	SKY65404-31EK1

Copyright © 2021 Skyworks Solutions, Inc. All Rights Reserved.

Information in this document is provided in connection with Skyworks Solutions, Inc. ("Skyworks") products or services. These materials, including the information contained herein, are provided by Skyworks as a service to its customers and may be used for informational purposes only by the customer. Skyworks assumes no responsibility for errors or omissions in these materials or the information contained herein. Skyworks may change its documentation, products, services, specifications or product descriptions at any time, without notice. Skyworks makes no commitment to update the materials or information and shall have no responsibility whatsoever for conflicts, incompatibilities, or other difficulties arising from any future changes.

No license, whether express, implied, by estoppel or otherwise, is granted to any intellectual property rights by this document. Skyworks assumes no liability for any materials, products or information provided hereunder, including the sale, distribution, reproduction or use of Skyworks products, information or materials, except as may be provided in Skyworks Terms and Conditions of Sale.

THE MATERIALS, PRODUCTS AND INFORMATION ARE PROVIDED "AS IS" WITHOUT WARRANTY OF ANY KIND, WHETHER EXPRESS, IMPLIED, STATUTORY, OR OTHERWISE, INCLUDING FITNESS FOR A PARTICULAR PURPOSE OR USE, MERCHANTABILITY, PERFORMANCE, QUALITY OR NON-INFRINGEMENT OF ANY INTELLECTUAL PROPERTY RIGHT; ALL SUCH WARRANTIES ARE HEREBY EXPRESSLY DISCLAIMED. SKYWORKS DOES NOT WARRANT THE ACCURACY OR COMPLETENESS OF THE INFORMATION, TEXT, GRAPHICS OR OTHER ITEMS CONTAINED WITHIN THESE MATERIALS. SKYWORKS SHALL NOT BE LIABLE FOR ANY DAMAGES, INCLUDING BUT NOT LIMITED TO ANY SPECIAL, INDIRECT, INCIDENTAL, STATUTORY, OR CONSEQUENTIAL DAMAGES, INCLUDING WITHOUT LIMITATION, LOST REVENUES OR LOST PROFITS THAT MAY RESULT FROM THE USE OF THE MATERIALS OR INFORMATION, WHETHER OR NOT THE RECIPIENT OF MATERIALS HAS BEEN ADVISED OF THE POSSIBILITY OF SUCH DAMAGE.

Skyworks products are not intended for use in medical, lifesaving or life-sustaining applications, or other equipment in which the failure of the Skyworks products could lead to personal injury, death, physical or environmental damage. Skyworks customers using or selling Skyworks products for use in such applications do so at their own risk and agree to fully indemnify Skyworks for any damages resulting from such improper use or sale.

Customers are responsible for their products and applications using Skyworks products, which may deviate from published specifications as a result of design defects, errors, or operation of products outside of published parameters or design specifications. Customers should include design and operating safeguards to minimize these and other risks. Skyworks assumes no liability for applications assistance, customer product design, or damage to any equipment resulting from the use of Skyworks products outside of stated published specifications or parameters.

Skyworks and the Skyworks symbol are trademarks or registered trademarks of Skyworks Solutions, Inc., in the United States and other countries. Third-party brands and names are for identification purposes only, and are the property of their respective owners. Additional information, including relevant terms and conditions, posted at www.skyworksinc.com, are incorporated by reference.