

G2-LXP2-RS2

~8.5° spot beam with light, black holder.
Assembly with installation tape.

SPECIFICATION:

Dimensions	Ø 21.8 mm
Height	14.7 mm
Fastening	tape
ROHS compliant	yes ⓘ



MATERIALS:

Component	Type	Material	Colour	Finish
LXP2-RS2	Single lens	PMMA		
LXP2-LT-HLD	Holder	PC	black	
HEIDI-TAPE	Tape	Acrylic foam	black	

ORDERING INFORMATION:

Component		Qty in box	MOQ	MPQ	Box weight (kg)
CA14506_G2-LXP2-RS2	Single lens	1680	336	112	8.1
» Box size: 480 x 280 x 300 mm					

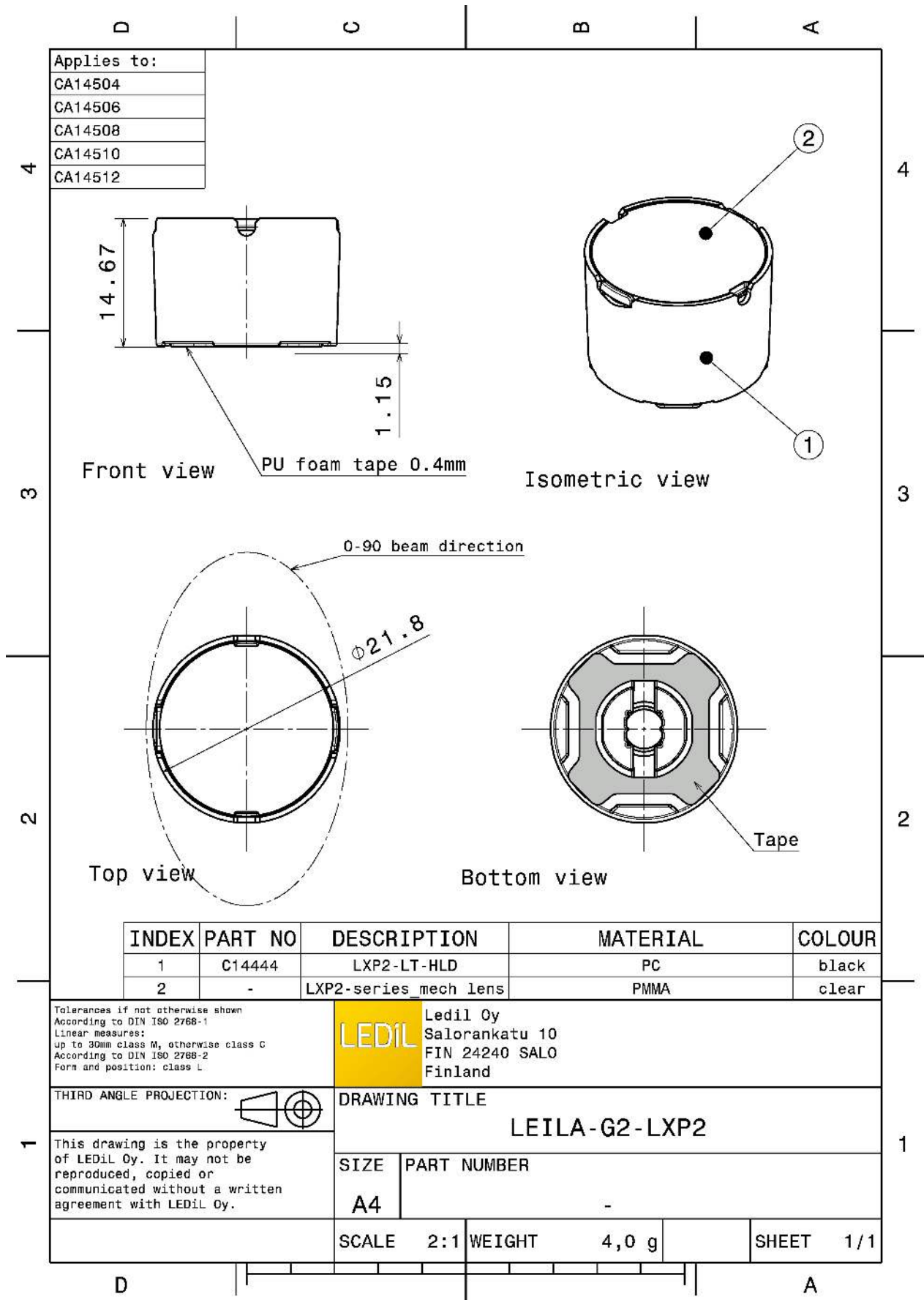

INDEX	PART NO	DESCRIPTION	MATERIAL	COLOUR
1	C14444	LXP2-LT-HLD	PC	black
2	-	LXP2-series mech lens	PMMA	clear

Tolerances if not otherwise shown
 According to DIN ISO 2768-1
 Linear measures:
 up to 30mm class M, otherwise class C
 According to DIN ISO 2768-2
 Form and position: class L

LEDiL Ledil Oy
 Salorankatu 10
 FIN 24240 SALO
 Finland

THIRD ANGLE PROJECTION:

DRAWING TITLE
LEILA-G2-LXP2



This drawing is the property of LEDiL Oy. It may not be reproduced, copied or communicated without a written agreement with LEDiL Oy.

SIZE	PART NUMBER
A4	-





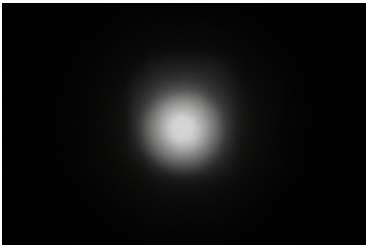
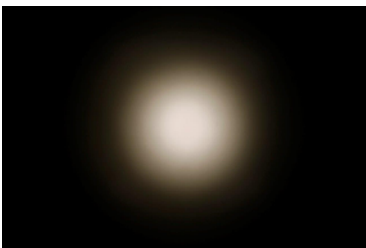
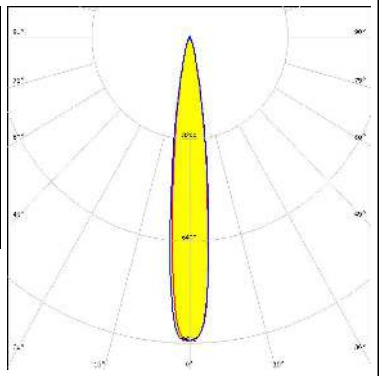

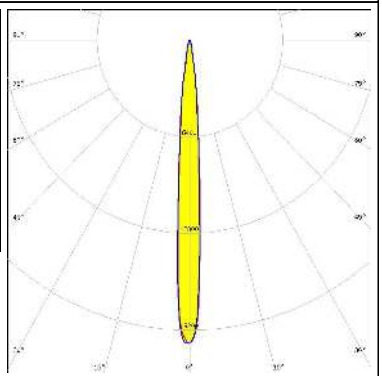
SCALE	2:1	WEIGHT	4,0 g	SHEET	1/1
-------	-----	--------	-------	-------	-----

See also our general installation guide: www.ledil.com/installation_guide

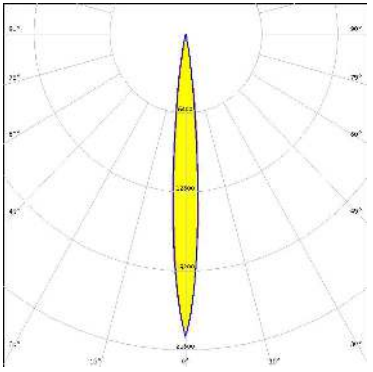
OPTICAL RESULTS (MEASURED):

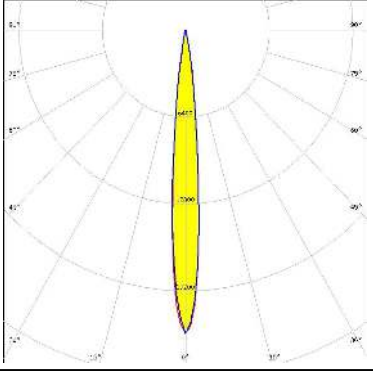
<p>CREE ⇄ LED</p> <p>LED XP-E FWHM / FWTM 7.0° / 15.0° Efficiency 88 % Peak intensity 34.7 cd/lm LEDs/each optic 1 Light colour White Required components:</p>		
<p>CREE ⇄ LED</p> <p>LED XP-L HD FWHM / FWTM 14.0° / 28.0° Efficiency 88 % Peak intensity 9.5 cd/lm LEDs/each optic 1 Light colour White Required components:</p>		
<p>CREE ⇄ LED</p> <p>LED XP-L HI FWHM / FWTM 8.0° / 19.0° Efficiency 89 % Peak intensity 20.1 cd/lm LEDs/each optic 1 Light colour White Required components:</p>		

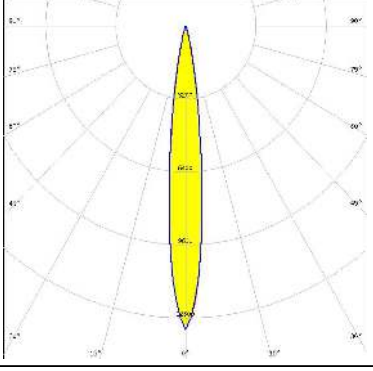
OPTICAL RESULTS (SIMULATED):

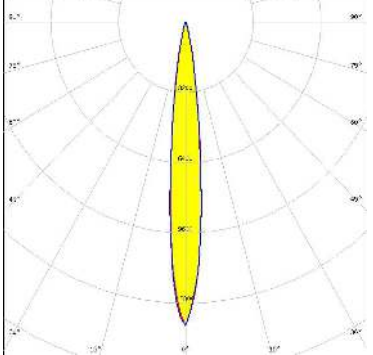
	<p>LED: XP-E2 FWHM / FWTM: 10.0° / 19.0° Efficiency: 94 % Peak intensity: 24.6 cd/lm LEDs/each optic: 1 Light colour: White Required components:</p>	
	<p>LED: XP-G2 FWHM / FWTM: 10.0° / 19.0° Efficiency: 93 % Peak intensity: 22.4 cd/lm LEDs/each optic: 1 Light colour: White Required components:</p>	
	<p>LED: XP-G2 HE FWHM / FWTM: 12.0° / 26.0° Efficiency: 91 % Peak intensity: 13.3 cd/lm LEDs/each optic: 1 Light colour: White Required components:</p>	
	<p>LED: XP-G3 FWHM / FWTM: 12.0° / 25.0° Efficiency: 90 % Peak intensity: 13.8 cd/lm LEDs/each optic: 1 Light colour: White Required components:</p>	

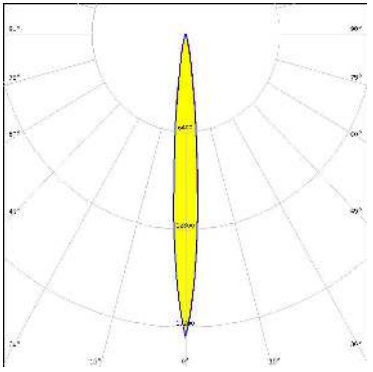
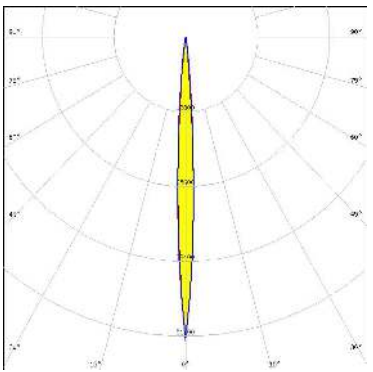
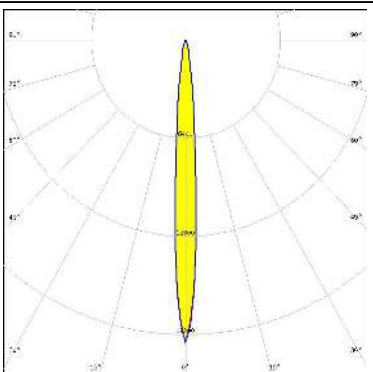
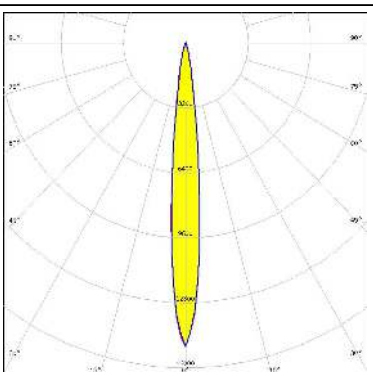

OPTICAL RESULTS (SIMULATED):

<p>CREE → LED</p> <p>LED: XT-E FWHM / FWTM: 9.5° / 21.0° Efficiency: 92 % Peak intensity: 19.9 cd/lm LEDs/each optic: 1 Light colour: White Required components:</p>	
<p>LUMILEDS</p> <p>LED: LUXEON CZ FWHM / FWTM: 6.0° / 14.0° Efficiency: 92 % Peak intensity: 52 cd/lm LEDs/each optic: 1 Light colour: Red Required components:</p>	
<p>NICHIA</p> <p>LED: NVSxE21A FWHM / FWTM: 8.0° / 20.0° Efficiency: 90 % Peak intensity: 19.8 cd/lm LEDs/each optic: 1 Light colour: White Required components:</p>	
<p>NICHIA</p> <p>LED: NVSxx19B/NVSxx19C FWHM / FWTM: 11.0° / 23.0° Efficiency: 88 % Peak intensity: 15 cd/lm LEDs/each optic: 1 Light colour: White Required components:</p>	

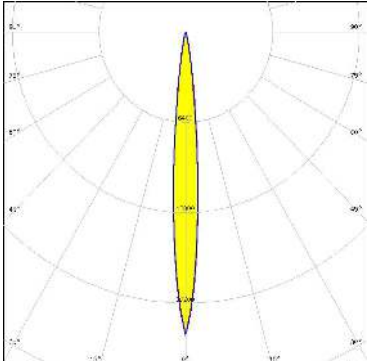
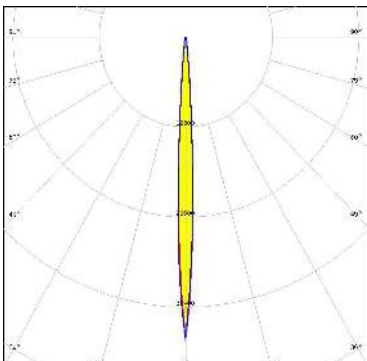
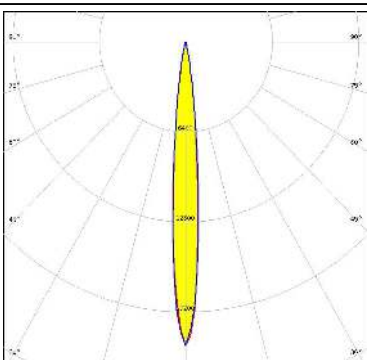
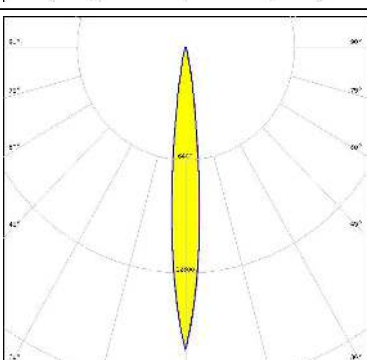
OPTICAL RESULTS (SIMULATED):

<p>OSRAM Opto Semiconductors</p> <p>LED: OSLOM Square CSSRM2/CSSRM3</p> <p>FWHM / FWTM: 10.0° / 20.0°</p> <p>Efficiency: 93 %</p> <p>Peak intensity: 21.5 cd/lm</p> <p>LEDs/each optic: 1</p> <p>Light colour: White</p> <p>Required components:</p>	
<p>OSRAM Opto Semiconductors</p> <p>LED: SFH 4170S</p> <p>FWHM / FWTM: 6.0° / 12.0°</p> <p>Efficiency: 79 %</p> <p>LEDs/each optic: 1</p> <p>Light colour: IR</p> <p>Required components:</p>	
<p>SAMSUNG</p> <p>LED: LH351A</p> <p>FWHM / FWTM: 9.0° / 20.0°</p> <p>Efficiency: 91 %</p> <p>Peak intensity: 21.6 cd/lm</p> <p>LEDs/each optic: 1</p> <p>Light colour: White</p> <p>Required components:</p>	
<p>SAMSUNG</p> <p>LED: LH351B</p> <p>FWHM / FWTM: 10.0° / 23.0°</p> <p>Efficiency: 91 %</p> <p>Peak intensity: 17.2 cd/lm</p> <p>LEDs/each optic: 1</p> <p>Light colour: White</p> <p>Required components:</p>	

OPTICAL RESULTS (SIMULATED):

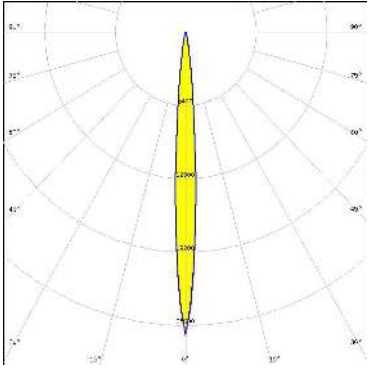
 SEOUL SEMICONDUCTOR		
LED	Z5M1/Z5M2	
FWHM / FWTM	10.0° / 20.0°	
Efficiency	93 %	
Peak intensity	20.5 cd/lm	
LEDs/each optic	1	
Light colour	White	
Required components:		
 SEOUL SEMICONDUCTOR		
LED	Z5P	
FWHM / FWTM	8.0° / 17.0°	
Efficiency	92 %	
Peak intensity	26.5 cd/lm	
LEDs/each optic	1	
Light colour	White	
Required components:		

GENERAL INFORMATION:

NOTE: The typical beam angle will be changed by different color, chip size and chip position tolerance. The typical total beam angle is the full angle measured where the luminous intensity is half of the peak value.

MATERIALS:

As part of our continuous research and improvement processes, and to ensure the best possible quality and availability of our products, LEDiL reserves the right to change material grades without notice.

PRODUCT DATA USER AGREEMENT AND DISCLAIMER:

The measured data in the provided downloadable LEDiL Product Datasheets and Mechanical 2D-Drawings is rounded and provided as reference for planning. LEDiL Oy's optical specifications have been verified by conducting performance testing of the products in accordance with the company's quality system. The reported data are averaged results of multiple measurements with typical variation. LEDiL Oy reserves the right to without prior notification make changes and improvements to its products.

LEDiL Oy assumes neither warranty, nor guarantee nor any other liability of any kind for the contents and correctness of the provided data. The provided data has been generated with highest diligence but the provided data may in reality not represent the complete possible variation range of all intrinsic parameters. Therefore, in certain cases a deviation from the provided data could occur.

LEDiL Oy reserves the right to undertake technical changes of its products without further notification which could lead to changes in the provided data. LEDiL Oy assumes no liability of any kind for the possible deviation from any provided data or any other damage resulting from the usage of the provided data.

The user agrees to this disclaimer and user agreement with the download or usage of the provided files.

LEDiL Oy

Joensuunkatu 13
FI-24240 SALO
Finland

LEDiL Inc.

228 West Page Street
Suite D
Sycamore IL 60178
USA

Ledil Optics Technology (Shenzhen) Co., Ltd.

405 , Block B
Casic Motor Building
Shenzhen 518057
P.R.CHINA

Local sales and technical support

[www.ledil.com/
where_to_buy](http://www.ledil.com/where_to_buy)

Shipping locations

Salo, Finland
Hong Kong, China

Distribution Partners

[www.ledil.com/
where_to_buy](http://www.ledil.com/where_to_buy)