

TPS548C26EVM 4-V to 16-V, 35-A Step-Down Converter Evaluation Module



Caleb Perez

ABSTRACT

This user's guide contains information for the TPS548C26EVM evaluation module (BSR152) as well as for the TPS548C26 DC/DC converter. This user's guide also includes performance specifications, schematic, layout, and bill of materials for the TPS548C26EVM.

Table of Contents

1 Introduction	2
1.1 Description.....	2
1.2 Before You Begin.....	3
2 Performance Characteristics	4
3 Test Point Descriptions	9
4 Test Setup	11
5 Configurations	12
5.1 Mode Selection.....	12
5.2 ILIM Selection.....	12
5.3 Soft-Start Selection.....	12
6 Schematics	13
7 PCB Layout	14
8 BOM	16

Trademarks

D-CAP+™ is a trademark of Texas Instruments.
All trademarks are the property of their respective owners.

1 Introduction

1.1 Description

The TPS548C26EVM is an evaluation module for the TPS548C26 DC/DC synchronous buck converter. The evaluation module accepts an 8-V to 16-V input and can deliver an output current up to 35 A. The converter uses D-CAP+™ control scheme for fast transient response, using less output capacitance to save board space. Rated input voltage and output current range for the evaluation module are given in [Table 1-1](#). [Figure 1-1](#) highlights the user interface items associated with the EVM.

The high-side and low-side MOSFETs are incorporated inside the package along with the gate-drive circuitry. The low drain-to-source on-resistance of the MOSFET allows the to achieve high efficiencies and helps keep the junction temperature low at the rated output current. Fixed frequency advanced current mode control allows you to synchronize the regulators to an external clock source. An external divider allows for an adjustable output voltage. The FSEL and MODE pins provide selectable switching frequency, soft-start time, current limit, and internal compensation. Lastly, the TPS548C26 includes an enable pin and a power-good output which can be used for sequencing multiple regulators.

Table 1-1. Input Voltage and Output Current Summary

EVM	INPUT VOLTAGE RANGE	OUTPUT CURRENT RANGE
TPS548C26EVM	8 V to 16 V	0 A to 35 A

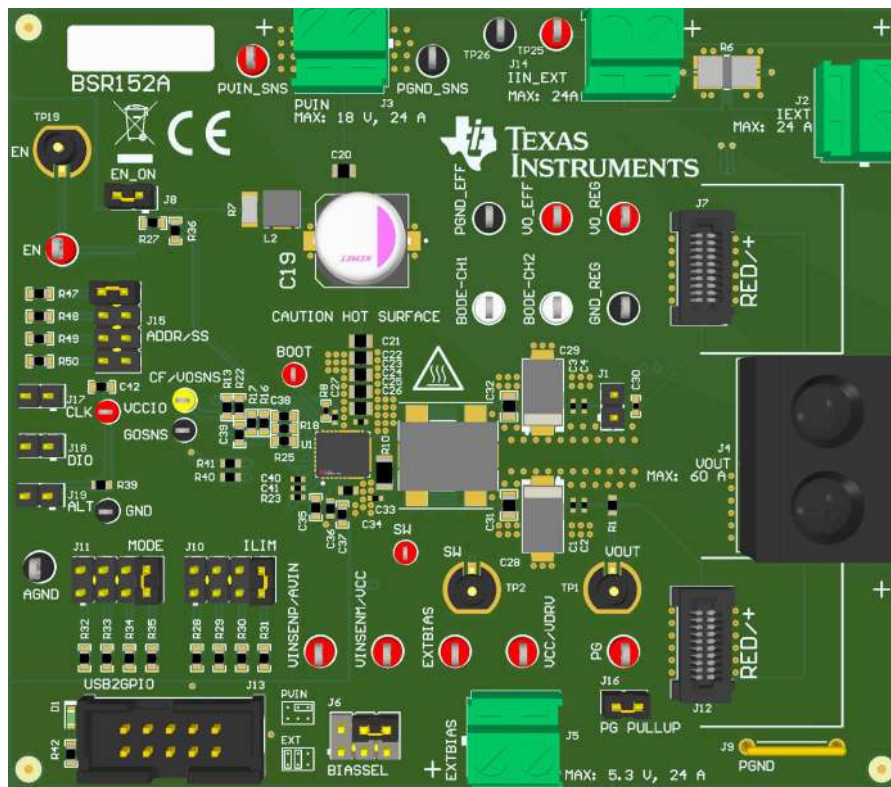



Figure 1-1. EVM User Interface

1.2 Before You Begin

The following warnings and cautions are noted for the safety of anyone using or working close to the TPS548C26EVM. Observe all safety precautions.

	Warning	The TPS548C26EVM can become hot during operation due to dissipation of power in some operating conditions. Avoid contact with the board. Follow all applicable safety procedures applicable to your laboratory.
---	----------------	---

WARNING

The circuit module has signal traces, components, and component leads on the bottom of the board. This can result in exposed voltages, hot surfaces or sharp edges. Do not reach under the board during operation.

CAUTION

Some power supplies can be damaged by application of external voltages. If using more than 1 power supply, check your equipment requirements and use blocking diodes or other isolation techniques, as needed, to prevent damage to your equipment.

2 Performance Characteristics

Table 2-1 provides a summary of the TPS548C26EVM performance characteristics. The TPS548C26EVM is designed and tested for $V_{IN} = 8\text{ V}$ to 16 V . Characteristics are given for an input voltage of $V_{IN} = 12\text{ V}$ and output voltage of 3.3 V , unless otherwise specified. The ambient temperature is room temperature (20°C to 25°C) for all measurements, unless otherwise noted.

Table 2-1. TPS548C26EVM Performance Characteristics Summary

SPECIFICATION	TEST CONDITIONS	MIN	TYP	MAX	UNIT
V_{IN} voltage range		8	12	16	V
PVIN input current	$PV_{IN} = 12\text{ V}$, internal VCC/VDRV, $I_O = 0\text{ A}$, Pulse-skip mode		15		mA
VCC/VDRV input current	External 5-V bias, $f_{SW} = 800\text{ kHz}$, $PV_{IN} = 12\text{ V}$, $I_O = 35\text{ A}$		38		mA
Output voltage setpoint			3.3		V
Output current range	$V_{IN} = 8\text{ V}$ to 16 V	0		35	A
Output ripple voltage	$f_{SW} = 800\text{ kHz}$, $I_O = 35\text{ A}$		28		mVPP
Output rise time			1		ms
Current limit	Set by J10		35		A
Switching frequency (f_{SW})	Set by J11	600	800	1200	kHz
Efficiency	$V_{IN} = 12\text{ V}$, external 5-V bias, $f_{SW} = 800\text{ kHz}$, $I_O = 35\text{ A}$		91		%
IC case temperature	$V_{IN} = 12\text{ V}$, external 5-V bias, $f_{SW} = 1.2\text{ MHz}$, $I_O = 35\text{ A}$, 15-minute dwell time		103		$^{\circ}\text{C}$

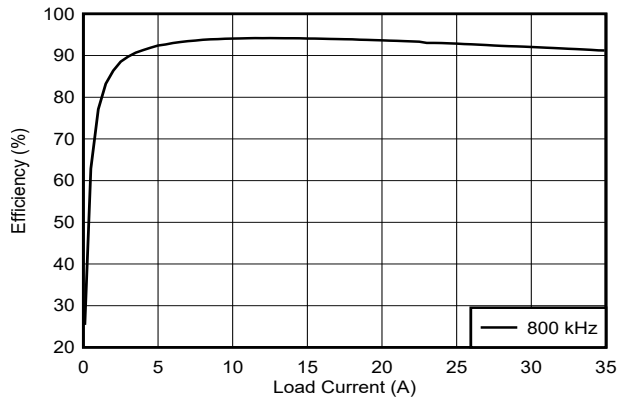

Figure 2-1. Efficiency, FCCM, Internal LDO

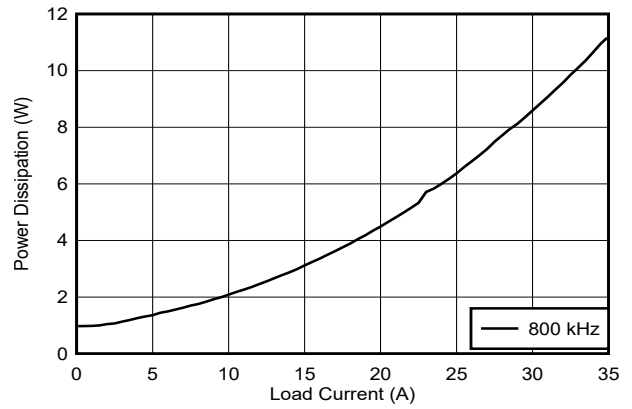

Figure 2-2. Power Dissipation, FCCM, Internal LDO

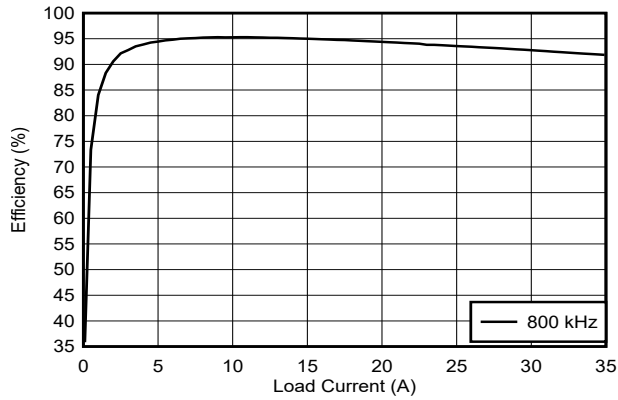

Figure 2-3. Efficiency, FCCM, External 5-V Bias

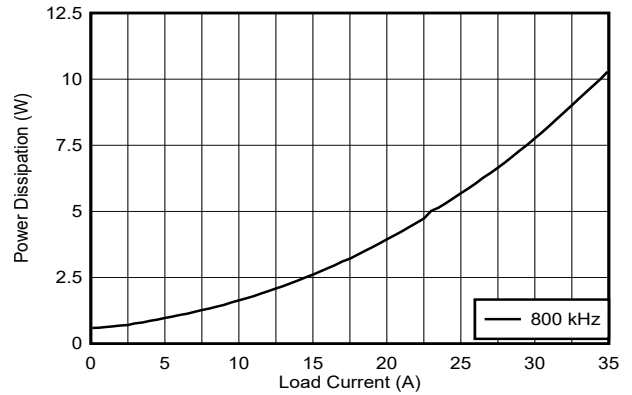

Figure 2-4. Power Dissipation, FCCM, External 5-V Bias

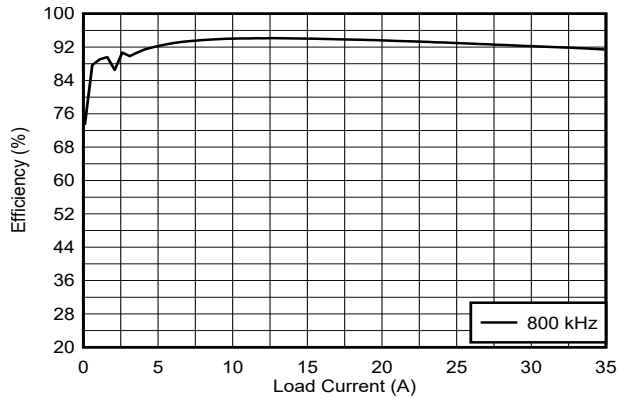

Figure 2-5. Efficiency, DCM, Internal LDO

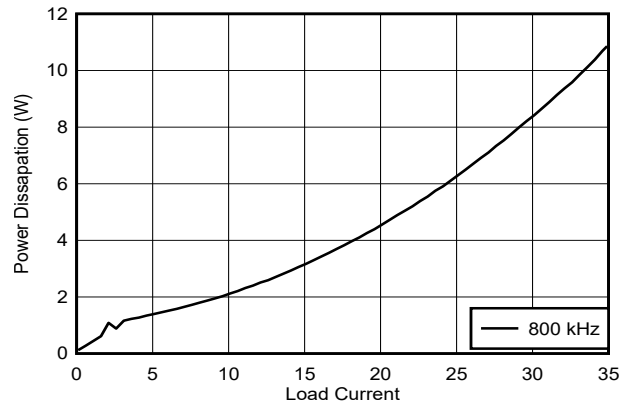

Figure 2-6. Power Dissipation, DCM, Internal LDO

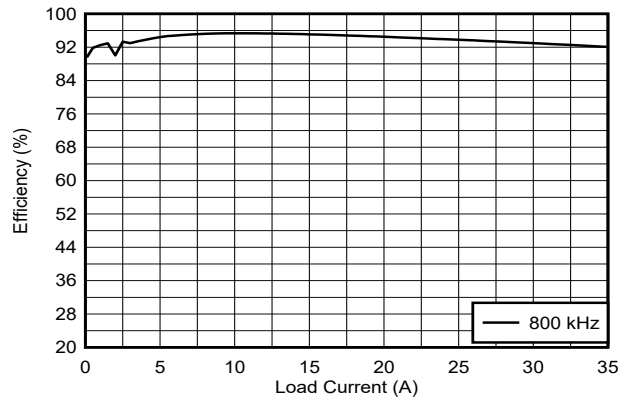

Figure 2-7. Efficiency, DCM, External 5-V Bias

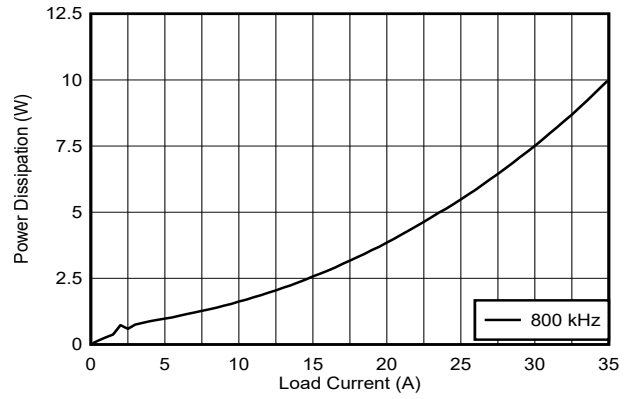

Figure 2-8. Power Dissipation, DCM, External 5-V Bias

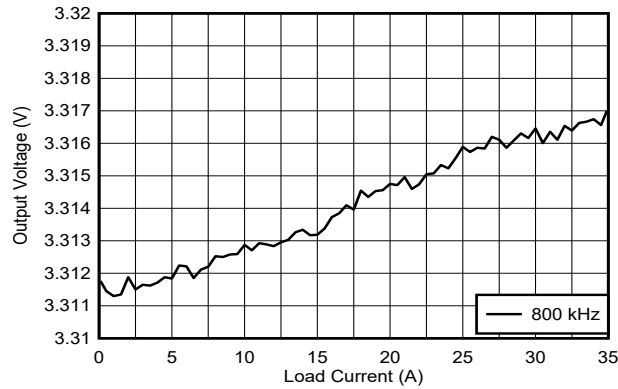

Figure 2-9. Load Regulation, FCCM, Internal LDO

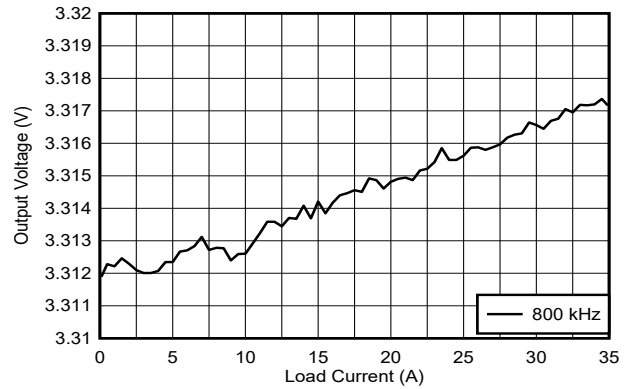

Figure 2-10. Load Regulation, FCCM, External 5-V Bias

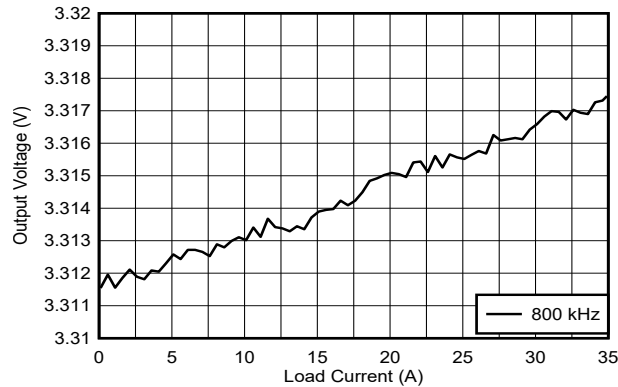

Figure 2-11. Load Regulation, DCM, Internal VCC LDO

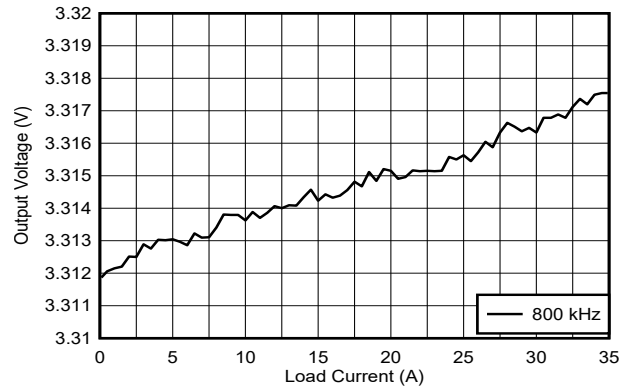

Figure 2-12. Load Regulation, DCM, External 5-V Bias

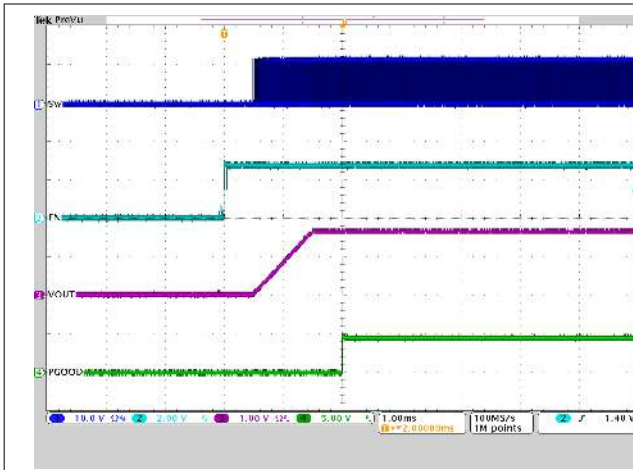

Figure 2-13. ENABLE Start-Up Waveform

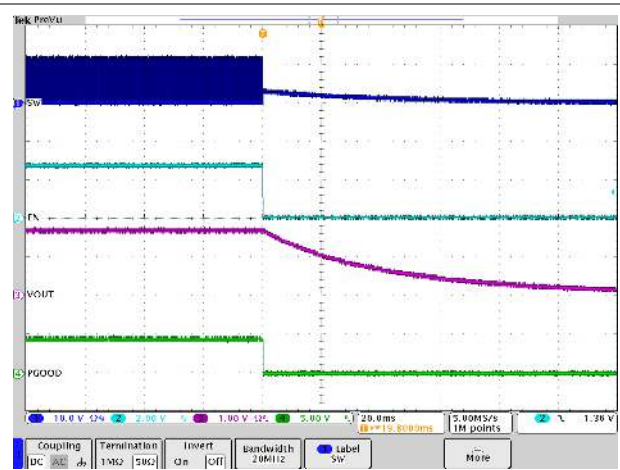

Figure 2-14. ENABLE Shutdown Waveform

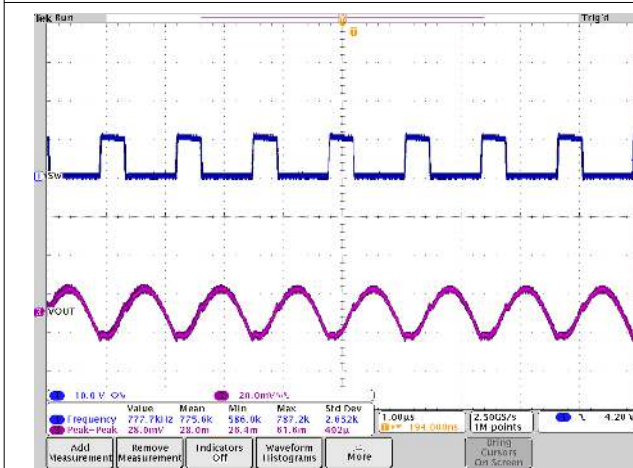

Figure 2-15. Output Voltage Ripple, 800-kHz FCCM, 35-A Load

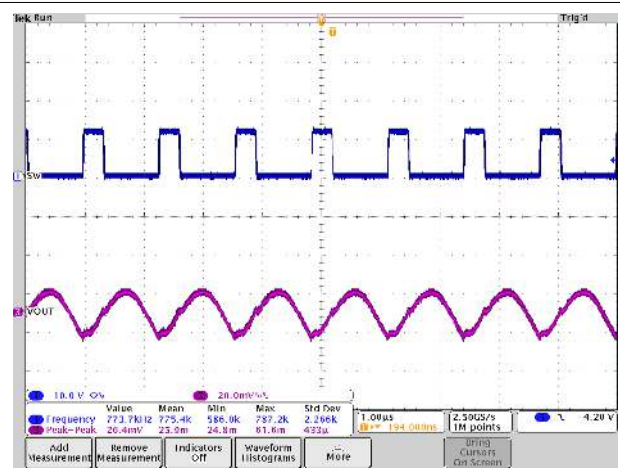

Figure 2-16. Output Voltage Ripple, 800-kHz FCCM, No Load

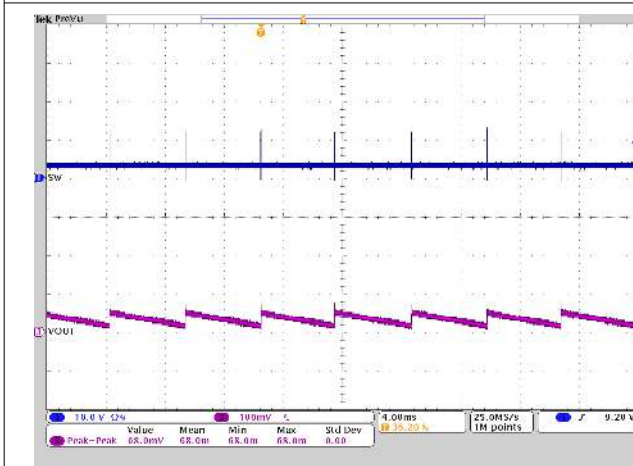

Figure 2-17. Output Voltage Ripple, DCM, No Load



Figure 2-18. Output Voltage Ripple, DCM, 1-A Load



Figure 2-19. Thermal Characteristics, 600-kHz FCCM, Internal LDO, 35-A Load



Figure 2-20. Thermal Characteristics, 600-kHz FCCM, External 5-V Bias, 35-A Load



Figure 2-21. Thermal Characteristics, 800-kHz FCCM, Internal LDO, 35-A Load

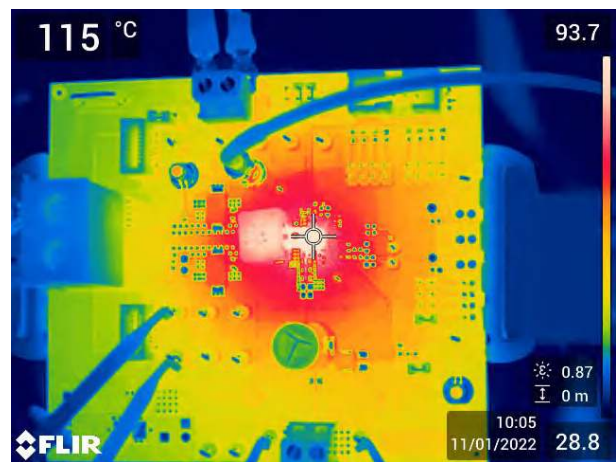

Figure 2-22. Thermal Characteristics, 800-kHz FCCM, External 5-V Bias, 35-A Load



Figure 2-23. Thermal Characteristics, 1.2-MHz FCCM, Internal LDO, 35-A Load

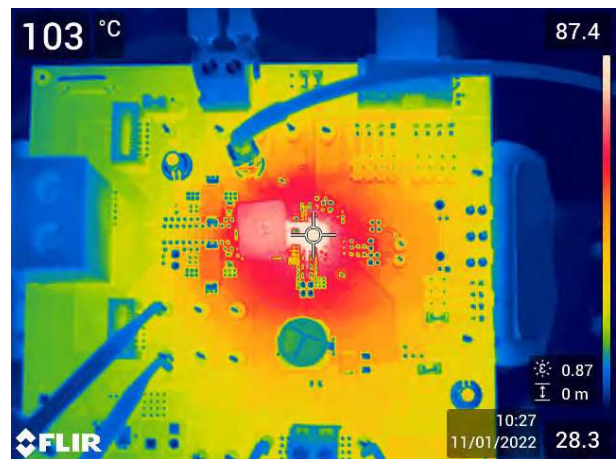

Figure 2-24. Thermal Characteristics, 1.2-MHz FCCM, External 5-V Bias, 35-A Load

3 Test Point Descriptions

A description of each test point follows:

Table 3-1. Connectors and Jumpers

REFERENCE DESIGNATOR	NAME	FUNCTION
J1	VOUT	Output voltage scope monitor
J2	IEXT	Load current interface for the input power telemetry
J3	PVIN	VIN screw terminal to connect input voltage (see Table 1-1 for V_{IN} range)
J4	VOUT	VOUT screw terminal to connect load to output
J5	EXTBIAS	Monitors internal LDO voltage or override internal LDO with external bias for improving efficiency
J6	BIASSEL	Pin header to select PVIN or an external VCC.
J7, J12	RED/+	Connector blocks to interface with Mini Slammer
J8	EN_ON	2-pin header for enable. Add shunt to connect EN to PVIN and enable device. Remove shunt to disable device.
J9	PGND	Power ground test point
J10	ILIM	Pin header block to select current limit.
J11	MODE	Pin header block to select switching mode and switching frequency.
J14	IIN_EXT	Screw terminal to apply an external voltage source for input power telemetry.
J15	ADDR/SS	Pin header block to select soft-start time
J16	PG_PULLUP	PGOOD pullup pin. 2-pin header to pull up PGOOD to VCC.

Table 3-2. Test Points

COLOR REFERNCE	NAME	FUNCTION
Red	PVIN_SNS	Positive side of input voltage sensing point
Red	EN	Monitors enable pin
Red	VCCIO	External 1-V pullup for SVID
Red	BOOT	Monitors the bootstrap capacitor voltage
Red	VINSEN/AVIN	Positive voltage of the power sense resistor on the input power telemetry
Red	VO_EFF	Excellent output voltage sense point to measure efficiency
Red	VO_REG	Monitors the output voltage
Red	SW	Monitors output switching terminal of the power converter
Red	VINSEN/VCC	Voltage reference point of the power sense resistor on the input power telemetry
Red	EXTBIAS	Monitors the voltage on EXBIAS
Red	VCC/VDRV	Monitors the voltage on VCC/VDRV
Red	PG	Monitors the power good signal
White	BODE-CH1	Inject frequency from the frequency response analyzer
White	BODE-CH2	Measurement point of the receiving end from the frequency response analyzer
Black	PGND_SNS	Reference side of input voltage sensing point
Black	GOSNS	Remote sense reference for PGND
Black	GND	Power ground test point
Black	AGND	Analog ground test point
Black	PGND_EFF	Excellent output voltage reference sense point to measure efficiency
Black	GND_REG	Output voltage PGND sense point
TP1	VOUT	Monitors output voltage
TP2	SW	Monitors output switching terminal of the power converter
TP19	EN	Monitors enable pin
TP25	IIN_EXT S+	Remote sense for the bias voltage used to supply the input power telemetry
TP26	IIN_EXT S-	Negative remote sense for the input power telemetry
TP27	VOSNS	Output voltage sense point for internal compensation circuitry

4 Test Setup

- A power supply capable of providing 10 A or greater must be connected to J3 (PVIN) through a pair of 14-AWG wires or better. The PVIN test points, PVIN_SNS and PGND_SNS, provide a place to monitor the PVIN input voltage. Do not use these monitoring test points as the input supply connection points. The PCB traces connecting to these test points are not designed to support high currents.
- The load must be connected to J4 (VOUT) with a pair of 10-AWG wires or better. Wire lengths must be minimized to reduce losses in the wires. If there is too much voltage drops in the wires, then the electronic load can not be able to sink the full rated current. The VO_REG test point is used to monitor the output voltage with GND_REG as the ground reference.
- Ensure that J8 is populated so that the part is enabled.
- Populate J6 to the correct bias selection - PVIN or EXT.
- When testing with an external 5-V bias supply to power VCC/VDRV, connect the external supply to J5 (EXTBIAS) with a pair of 20-AWG wires or better.
- To test the VINSEN function, connect a load to J2 (IEXT) with a pair of 14-AWG wires or better. When testing this function, the PVIN power supply must be capable of sourcing this additional external load current. Additionally, the load must have the proper voltage and power rating. For example, when the voltage at PVIN is 12 V and if pulling 20 A out of J2, the power supply must also source an additional 20 A and the load must have a power rating of at least 240 W.
- If modifications are made to the TPS548C26EVM, the input current can change. The input power supply and wires connecting the EVM to the power supply must be rated for the input current.

5 Configurations

All Jumper selections must be made prior to applying power to the EVM. Configure this EVM using the following configuration selections.

5.1 Mode Selection

MODE can be set by J11.

Table 5-1. TPS548B27EVM Mode Pin Selection

Switching Frequency (F_{sw})	Operation Mode Under Light Load	Mode Pin Connections	
		Connection	Jumper Setting
800 kHz	Forced CCM	Floating	Open
600 kHz		0 k Ω \pm 1% to AGND	Short Pins 1 and 2
1000 kHz		2.49 k Ω \pm 1% to AGND	Short Pins 3 and 4
600 kHz	Skip Mode	10.5 k Ω \pm 1% to AGND	Short Pins 5 and 6
800 kHz		12.1 k Ω \pm 10% to AGND	Short Pins 7 and 8

5.2 ILIM Selection

ILIM can be set by J10.

Table 5-2. TPS548B27EVM ILIM Pin Selection

LS OCL (A) (Valley Current Detection)	Pin 1 ILIM Connection	Jumper Setting
19A	12.1 k Ω \pm 1% to AGND	Short Pins 1 and 2
26A	16.2 k Ω \pm 1% to AGND	Short Pins 3 and 4
33A	21.5 k Ω \pm 1% to AGND	Short Pins 5 and 6
39A	24.9 k Ω \pm 10% to AGND	Short Pins 7 and 8

5.3 Soft-Start Selection

Soft-start time can be set by J15.

Table 5-3. TPS548B27EVM Soft-Start Pin Selection

Soft-start (ms)	Internal Compensation	Vout UV and OV Fault Response	Pin 29 SS Connection	Jumper Setting
4	RAMP1	Latch-off	Floating	Open
1			0 Ω \pm 1% to AGND	Short Pins 1 and 2
2	RAMP2		5.76 k Ω \pm 1% to AGND	Short Pins 3 and 4
2	RAMP1	Hiccup	12.1 k Ω \pm 1% to AGND	Short Pins 5 and 6
1	RAMP2		18.7 k Ω \pm 10% to AGND	Short Pins 7 and 8

6 Schematics

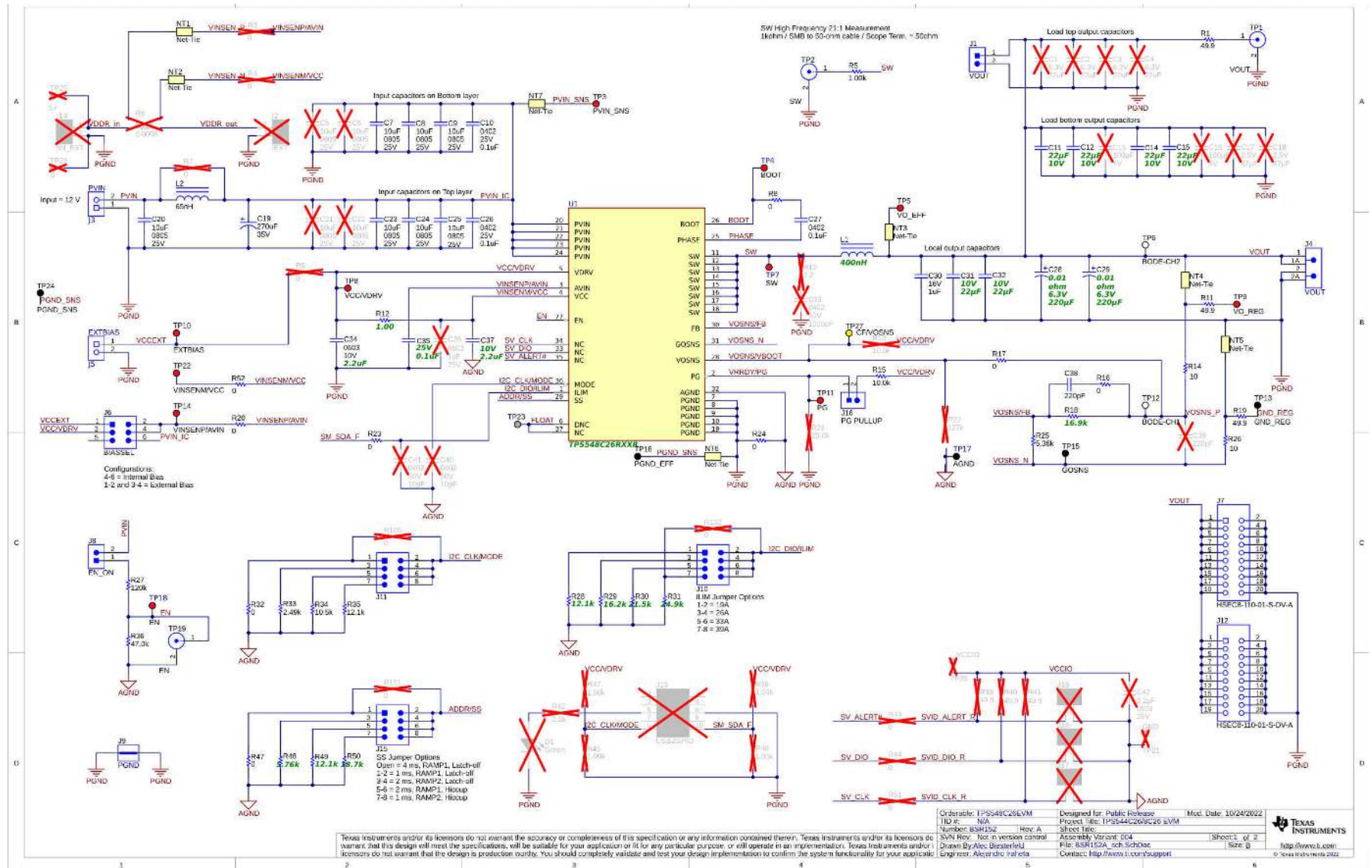

Figure 6-1. TPS548C26EVM Schematic

7 PCB Layout

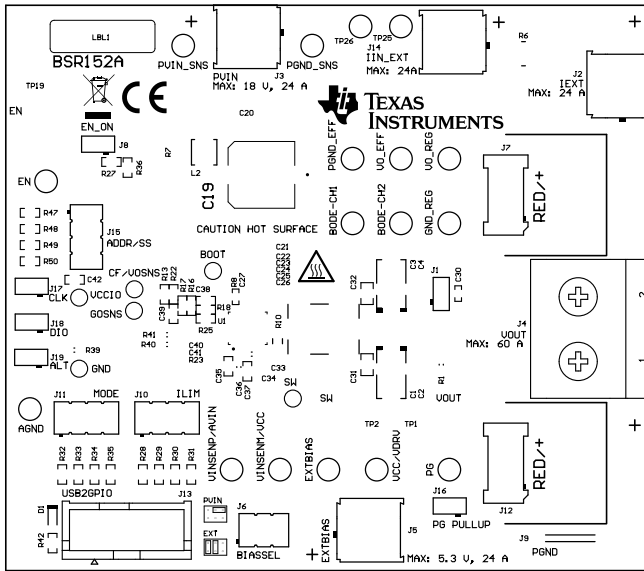

Figure 7-1. TPS548C26EVM Top Composite View

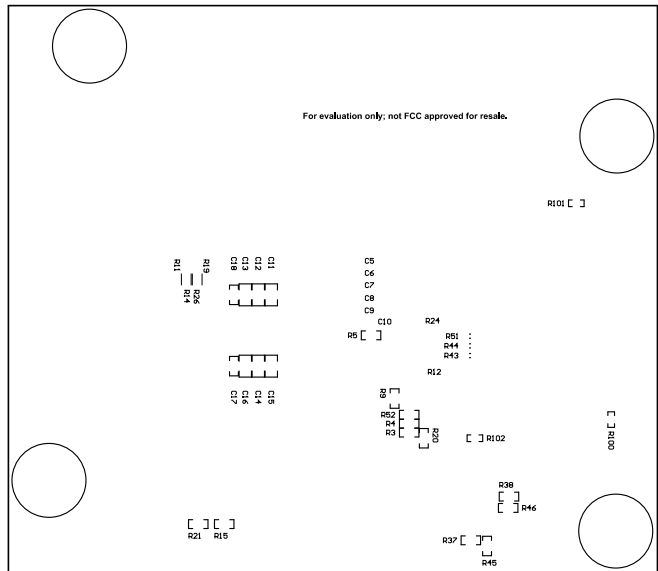

Figure 7-2. TPS548C26EVM Bottom Composite View (Viewed From Bottom)

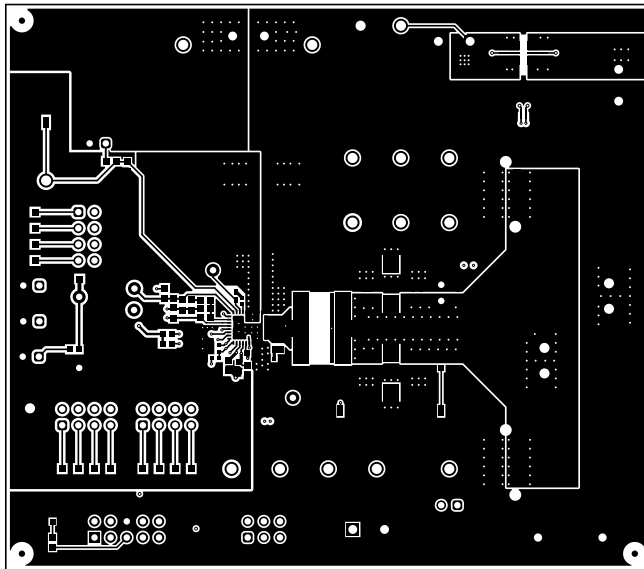

Figure 7-3. TPS548C26EVM Top Layer

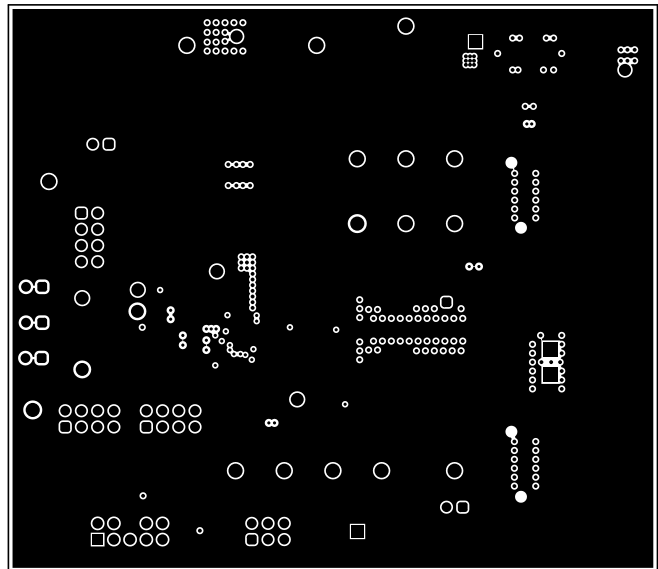

Figure 7-4. TPS548C26EVM Layer 2

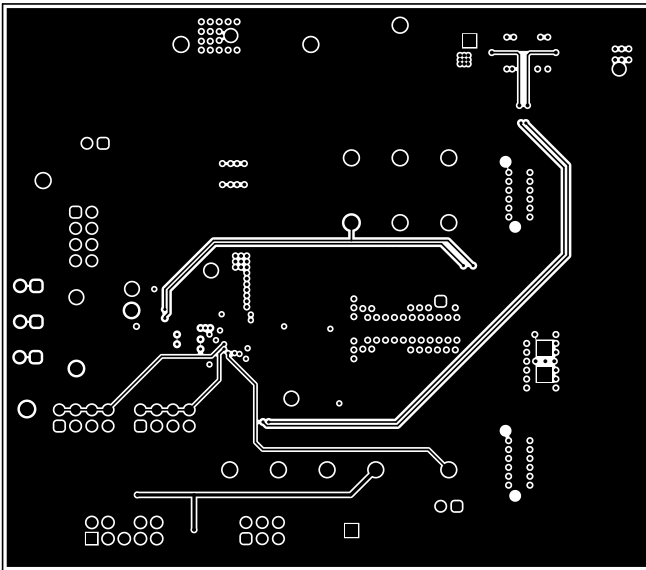

Figure 7-5. TPS548C26EVM Layer 3

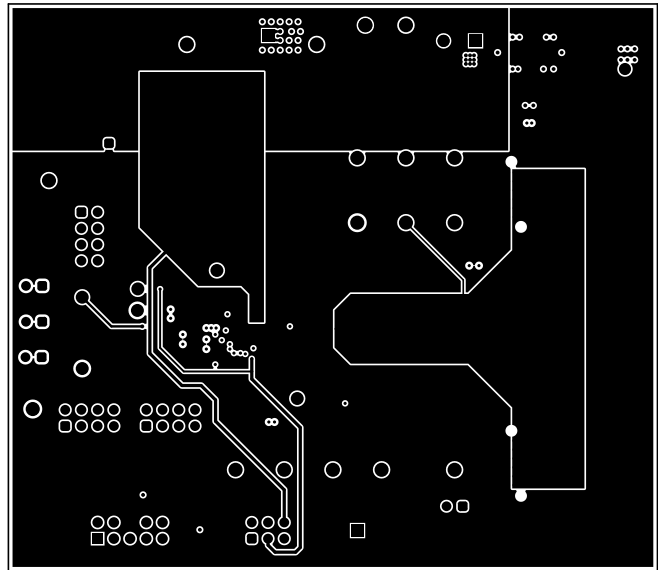

Figure 7-6. TPS548C26EVM Layer 4

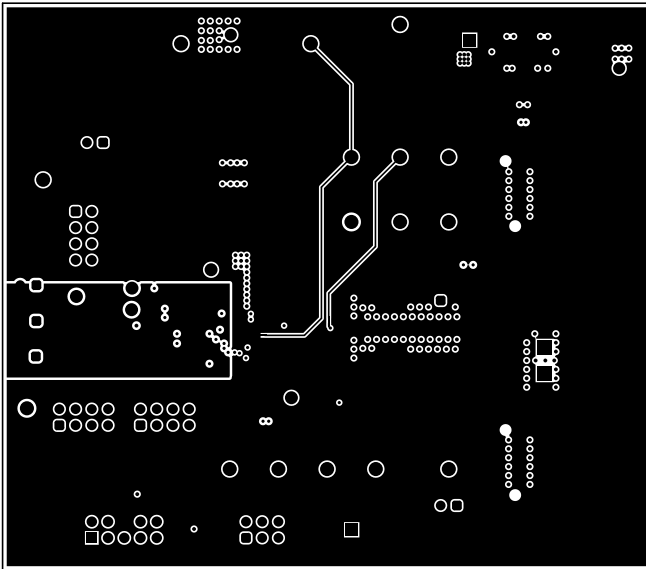

Figure 7-7. TPS548C26EVM Layer 5

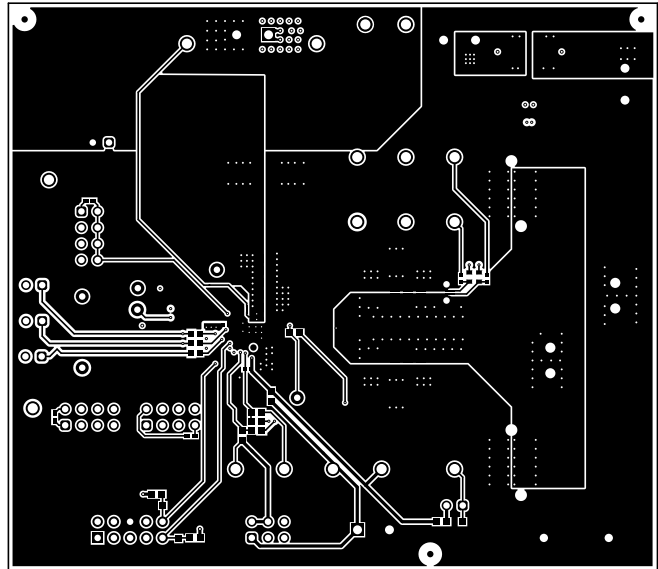

Figure 7-8. TPS548C26EVM Bottom Layer

8 BOM

Table 8-1. Bill of Materials

Designator	Quantity	Value	Description	Package Reference	Part Number	Manufacturer
!PCB1	1		Printed Circuit Board		BSR152-004	Any
C7, C8, C9, C20, C23, C24, C25	7	10uF	CAP, CERM, 10 uF, 25 V, +/- 10%, X7R, 0805	0805	GRM21BZ71E106KE1 5L	MuRata
C10, C26, C27	3	0.1uF	CAP, CERM, 0.1 uF, 25 V, +/- 10%, X7R, 0402	0402	GRM155R71E104KE1 4D	MuRata
C11, C12, C14, C15, C31, C32	6	22uF	CAP, CERM, 22 uF, 10 V, +/- 20%, X6S, 0805	0805	GRM21BC81A226ME4 4	MuRata
C19	1	270uF	Cap Aluminum Polymer 270uF 35V 20% Solder Cylindrical 22m Ohm 2200mA 2000 hr 125°C T/R	SMT_CAP_10MM3_ 10MM3	A768MS277M1VLAEO 22	KEMET
C28, C29	2	220uF	CAP, Aluminum Polymer, 220 uF, 6.3 V,+/- 20%, 0.01 ohm, 7343-31 SMD	7343-31	ECASD60J227M010K 00	MuRata
C30	1	1uF	CAP, CERM, 1 uF, 16 V, +/- 10%, X6S, 0402	0402	C1005X6S1C105K050 BC	TDK
C34, C37	2	2.2uF	CAP, CERM, 2.2 uF, 10 V, +/- 10%, X7R, 0603	0603	C1608X7R1A225K080 AC	TDK
C35	1	0.1uF	CAP, CERM, 0.1 uF, 25 V, +/- 5%, X7R, 0603	0603	06033C104JAT2A	AVX
C38	1	220pF	CAP, CERM, 220 pF, 50 V, +/- 5%, C0G/NP0, 0603	0603	C0603C221J5GACTU	Kemet
J1	1		Header, 2.54mm, 2x1, Gold, TH	Header, 2.54mm, 2x1, TH	TSW-102-08-G-S	Samtec
J3	1		Therminal Block, 5 mm, 2-pole, Tin, TH	TH, 2-Leads, Body 10x10mm, Pitch 5mm	282856-2	TE Connectivity
J4	1		Terminal Block, 60A, 10.16mm Pitch, 2-Pos, TH	21.8x30x19 mm	399100102	Molex
J5	1		Therminal Block, 5 mm, 2-pole, Tin, TH	TH, 2-Leads, Body 10x10mm, Pitch 5mm	282856-2	TE Connectivity
J6	1		Header, 2.54mm, 3x2, Gold, TH	Header, 2.54mm, 3x2, Gold, TH	HTSW-103-07-G-D	Samtec
J7, J12	2		Card Edge Socket, 0.8mm, 10x2, SMT	Card Edge Socket, 0.8mm, 10x2, SMT	HSEC8-110-01-S-DV-A	Samtec
J8	1		Header, 2.54mm, 2x1, Gold, TH	Header, 2.54mm, 2x1, TH	TSW-102-08-G-S	Samtec
J9	1		1mm Uninsulated Shorting Plug, 10.16mm spacing, TH	Shorting Plug, 10.16mm spacing, TH	D3082-05	Harwin
J10	1		Header, 2.54mm, 4x2, Gold, TH	Header, 2.54mm, 4x2, TH	TSW-104-08-L-D	Samtec
J11	1		Header, 2.54mm, 4x2, Gold, TH	Header, 2.54mm, 4x2, TH	TSW-104-08-L-D	Samtec

Table 8-1. Bill of Materials (continued)

Designator	Quantity	Value	Description	Package Reference	Part Number	Manufacturer
J15	1		Header, 2.54mm, 4x2, Gold, TH	Header, 2.54mm, 4x2, TH	TSW-104-08-L-D	Samtec
J16	1		Header, 2.54mm, 2x1, Gold, TH	Header, 2.54mm, 2x1, TH	TSW-102-08-G-S	Samtec
L1	1	400nH	Inductor, Shielded, Composite, 400 nH, 36.8 A, 0.0008 ohm, AEC-Q200 Grade 1, SMD	Inductor, 10x6x11.3mm	XAL1060-401MEB	Coilcraft
L2	1	65nH	Inductor, Ferrite, 65 nH, 19 A, 0.00032 ohm, SMD	4.0x4.0x4.0mm	FP0404R1-R065-R	Coiltronics
R1	1	49.9	RES, 49.9, 1%, 0.1 W, 0603	0603	RC0603FR-0749R9L	Yageo
R5	1	1.00k	RES, 1.00 k, 1%, 0.1 W, 0603	0603	RC0603FR-071KL	Yageo
R8	1	0	RES, 0, 5%, 0.1 W, AEC-Q200 Grade 0, 0402	0402	ERJ-2GE0R00X	Panasonic
R11, R19	2	49.9	RES, 49.9, 1%, 0.1 W, AEC-Q200 Grade 0, 0402	0402	ERJ-2RKF49R9X	Panasonic
R12	1	1	RES, 1.00, 1%, 0.125 W, 0402	0402	CSR0402FK1R00	Stackpole Electronics Inc
R14, R26	2	10	Thick Film Resistors - SMD 0603 10ohms 5% AEC-Q200	0603	ERJ-3GEYJ100V	Panasonic
R15	1	10.0k	RES, 10.0 k, 1%, 0.1 W, 0603	0603	ERJ-3EKF1002V	Panasonic
R16, R17, R20, R32, R47, R52	6	0	RES, 0, 5%, 0.1 W, 0603	0603	RC0603JR-070RL	Yageo
R18	1	16.9k	RES, 16.9 k, 1%, 0.1 W, 0603	0603	RC0603FR-0716K9L	Yageo
R23, R24	2	0	RES, 0, 5%, 0.1 W, AEC-Q200 Grade 0, 0402	0402	ERJ-2GE0R00X	Panasonic
R25	1	5.36k	RES, 5.36 k, 1%, 0.1 W, 0603	0603	RC0603FR-075K36L	Yageo
R27	1	120k	RES, 120 k, 1%, 0.1 W, 0603	0603	RC0603FR-07120KL	Yageo
R28	1	12.1k	RES, 12.1 k, 0.1%, 0.1 W, 0603	0603	RT0603BRD0712K1L	Yageo America
R29	1	16.2k	RES, 16.2 k, 1%, 0.1 W, 0603	0603	RC0603FR-0716K2L	Yageo
R30	1	21.5k	RES, 21.5 k, 1%, 0.1 W, 0603	0603	RC0603FR-0721K5L	Yageo
R31	1	24.9k	RES, 24.9 k, 1%, 0.1 W, 0603	0603	RC0603FR-0724K9L	Yageo
R33	1	2.49k	RES, 2.49 k, 1%, 0.1 W, 0603	0603	RC0603FR-072K49L	Yageo
R34	1	10.5k	RES, 10.5 k, 1%, 0.1 W, 0603	0603	RC0603FR-0710K5L	Yageo
R35, R49	2	12.1k	RES, 12.1 k, 1%, 0.1 W, 0603	0603	RC0603FR-0712K1L	Yageo
R36	1	47.0k	RES, 47.0 k, 1%, 0.1 W, 0603	0603	RC0603FR-0747KL	Yageo
R48	1	5.76k	RES, 5.76 k, 1%, 0.1 W, 0603	0603	RC0603FR-075K76L	Yageo
R50	1	18.7k	RES, 18.7 k, 1%, 0.1 W, 0603	0603	RC0603FR-0718K7L	Yageo
TP1	1		Connector, Receptacle, 50 ohm, TH	SMB Connector	SMBR004D00	JAE Electronics
TP2	1		Connector, Receptacle, 50 ohm, TH	SMB Connector	SMBR004D00	JAE Electronics
TP3	1		Test Point, Multipurpose, Red, TH	Red Multipurpose Testpoint	5010	Keystone
TP4	1		Test Point, Miniature, Red, TH	Red Miniature Testpoint	5000	Keystone

Table 8-1. Bill of Materials (continued)

Designator	Quantity	Value	Description	Package Reference	Part Number	Manufacturer
TP5	1		Test Point, Multipurpose, Red, TH	Red Multipurpose Testpoint	5010	Keystone
TP6	1		Test Point, Multipurpose, White, TH	White Multipurpose Testpoint	5012	Keystone
TP7	1		Test Point, Miniature, Red, TH	Red Miniature Testpoint	5000	Keystone
TP8	1		Test Point, Multipurpose, Red, TH	Red Multipurpose Testpoint	5010	Keystone
TP9	1		Test Point, Multipurpose, Red, TH	Red Multipurpose Testpoint	5010	Keystone
TP10	1		Test Point, Multipurpose, Red, TH	Red Multipurpose Testpoint	5010	Keystone
TP11	1		Test Point, Multipurpose, Red, TH	Red Multipurpose Testpoint	5010	Keystone
TP12	1		Test Point, Multipurpose, White, TH	White Multipurpose Testpoint	5012	Keystone
TP13	1		Test Point, Multipurpose, Black, TH	Black Multipurpose Testpoint	5011	Keystone
TP14	1		Test Point, Multipurpose, Red, TH	Red Multipurpose Testpoint	5010	Keystone
TP15	1		Test Point, Miniature, Black, TH	Black Miniature Testpoint	5001	Keystone
TP16	1		Test Point, Multipurpose, Black, TH	Black Multipurpose Testpoint	5011	Keystone
TP17	1		Test Point, Multipurpose, Black, TH	Black Multipurpose Testpoint	5011	Keystone
TP18	1		Test Point, Multipurpose, Red, TH	Red Multipurpose Testpoint	5010	Keystone
TP19	1		Connector, Receptacle, 50 ohm, TH	SMB Connector	SMBR004D00	JAE Electronics
TP22	1		Test Point, Multipurpose, Red, TH	Red Multipurpose Testpoint	5010	Keystone
TP24	1		Test Point, Multipurpose, Black, TH	Black Multipurpose Testpoint	5011	Keystone
TP27	1		Test Point, Miniature, Yellow, TH	Yellow Miniature Testpoint	5004	Keystone
U1	1		TPS548C26RXXR	WQFN-FCRLF37	TPS548C26RXXR	Texas Instruments

STANDARD TERMS FOR EVALUATION MODULES

1. *Delivery:* TI delivers TI evaluation boards, kits, or modules, including any accompanying demonstration software, components, and/or documentation which may be provided together or separately (collectively, an "EVM" or "EVMs") to the User ("User") in accordance with the terms set forth herein. User's acceptance of the EVM is expressly subject to the following terms.
 - 1.1 EVMs are intended solely for product or software developers for use in a research and development setting to facilitate feasibility evaluation, experimentation, or scientific analysis of TI semiconductors products. EVMs have no direct function and are not finished products. EVMs shall not be directly or indirectly assembled as a part or subassembly in any finished product. For clarification, any software or software tools provided with the EVM ("Software") shall not be subject to the terms and conditions set forth herein but rather shall be subject to the applicable terms that accompany such Software
 - 1.2 EVMs are not intended for consumer or household use. EVMs may not be sold, sublicensed, leased, rented, loaned, assigned, or otherwise distributed for commercial purposes by Users, in whole or in part, or used in any finished product or production system.
2. *Limited Warranty and Related Remedies/Disclaimers:*
 - 2.1 These terms do not apply to Software. The warranty, if any, for Software is covered in the applicable Software License Agreement.
 - 2.2 TI warrants that the TI EVM will conform to TI's published specifications for ninety (90) days after the date TI delivers such EVM to User. Notwithstanding the foregoing, TI shall not be liable for a nonconforming EVM if (a) the nonconformity was caused by neglect, misuse or mistreatment by an entity other than TI, including improper installation or testing, or for any EVMs that have been altered or modified in any way by an entity other than TI, (b) the nonconformity resulted from User's design, specifications or instructions for such EVMs or improper system design, or (c) User has not paid on time. Testing and other quality control techniques are used to the extent TI deems necessary. TI does not test all parameters of each EVM. User's claims against TI under this Section 2 are void if User fails to notify TI of any apparent defects in the EVMs within ten (10) business days after delivery, or of any hidden defects with ten (10) business days after the defect has been detected.
 - 2.3 TI's sole liability shall be at its option to repair or replace EVMs that fail to conform to the warranty set forth above, or credit User's account for such EVM. TI's liability under this warranty shall be limited to EVMs that are returned during the warranty period to the address designated by TI and that are determined by TI not to conform to such warranty. If TI elects to repair or replace such EVM, TI shall have a reasonable time to repair such EVM or provide replacements. Repaired EVMs shall be warranted for the remainder of the original warranty period. Replaced EVMs shall be warranted for a new full ninety (90) day warranty period.

WARNING

Evaluation Kits are intended solely for use by technically qualified, professional electronics experts who are familiar with the dangers and application risks associated with handling electrical mechanical components, systems, and subsystems.

User shall operate the Evaluation Kit within TI's recommended guidelines and any applicable legal or environmental requirements as well as reasonable and customary safeguards. Failure to set up and/or operate the Evaluation Kit within TI's recommended guidelines may result in personal injury or death or property damage. Proper set up entails following TI's instructions for electrical ratings of interface circuits such as input, output and electrical loads.

NOTE:

EXPOSURE TO ELECTROSTATIC DISCHARGE (ESD) MAY CAUSE DEGRADATION OR FAILURE OF THE EVALUATION KIT; TI RECOMMENDS STORAGE OF THE EVALUATION KIT IN A PROTECTIVE ESD BAG.

3 Regulatory Notices:

3.1 United States

3.1.1 Notice applicable to EVMs not FCC-Approved:

FCC NOTICE: This kit is designed to allow product developers to evaluate electronic components, circuitry, or software associated with the kit to determine whether to incorporate such items in a finished product and software developers to write software applications for use with the end product. This kit is not a finished product and when assembled may not be resold or otherwise marketed unless all required FCC equipment authorizations are first obtained. Operation is subject to the condition that this product not cause harmful interference to licensed radio stations and that this product accept harmful interference. Unless the assembled kit is designed to operate under part 15, part 18 or part 95 of this chapter, the operator of the kit must operate under the authority of an FCC license holder or must secure an experimental authorization under part 5 of this chapter.

3.1.2 For EVMs annotated as FCC – FEDERAL COMMUNICATIONS COMMISSION Part 15 Compliant:

CAUTION

This device complies with part 15 of the FCC Rules. Operation is subject to the following two conditions: (1) This device may not cause harmful interference, and (2) this device must accept any interference received, including interference that may cause undesired operation.

Changes or modifications not expressly approved by the party responsible for compliance could void the user's authority to operate the equipment.

FCC Interference Statement for Class A EVM devices

NOTE: This equipment has been tested and found to comply with the limits for a Class A digital device, pursuant to part 15 of the FCC Rules. These limits are designed to provide reasonable protection against harmful interference when the equipment is operated in a commercial environment. This equipment generates, uses, and can radiate radio frequency energy and, if not installed and used in accordance with the instruction manual, may cause harmful interference to radio communications. Operation of this equipment in a residential area is likely to cause harmful interference in which case the user will be required to correct the interference at his own expense.

FCC Interference Statement for Class B EVM devices

NOTE: This equipment has been tested and found to comply with the limits for a Class B digital device, pursuant to part 15 of the FCC Rules. These limits are designed to provide reasonable protection against harmful interference in a residential installation. This equipment generates, uses and can radiate radio frequency energy and, if not installed and used in accordance with the instructions, may cause harmful interference to radio communications. However, there is no guarantee that interference will not occur in a particular installation. If this equipment does cause harmful interference to radio or television reception, which can be determined by turning the equipment off and on, the user is encouraged to try to correct the interference by one or more of the following measures:

- Reorient or relocate the receiving antenna.
- Increase the separation between the equipment and receiver.
- Connect the equipment into an outlet on a circuit different from that to which the receiver is connected.
- Consult the dealer or an experienced radio/TV technician for help.

3.2 Canada

3.2.1 For EVMs issued with an Industry Canada Certificate of Conformance to RSS-210 or RSS-247

Concerning EVMs Including Radio Transmitters:

This device complies with Industry Canada license-exempt RSSs. Operation is subject to the following two conditions:

(1) this device may not cause interference, and (2) this device must accept any interference, including interference that may cause undesired operation of the device.

Concernant les EVMs avec appareils radio:

Le présent appareil est conforme aux CNR d'Industrie Canada applicables aux appareils radio exempts de licence. L'exploitation est autorisée aux deux conditions suivantes: (1) l'appareil ne doit pas produire de brouillage, et (2) l'utilisateur de l'appareil doit accepter tout brouillage radioélectrique subi, même si le brouillage est susceptible d'en compromettre le fonctionnement.

Concerning EVMs Including Detachable Antennas:

Under Industry Canada regulations, this radio transmitter may only operate using an antenna of a type and maximum (or lesser) gain approved for the transmitter by Industry Canada. To reduce potential radio interference to other users, the antenna type and its gain should be so chosen that the equivalent isotropically radiated power (e.i.r.p.) is not more than that necessary for successful communication. This radio transmitter has been approved by Industry Canada to operate with the antenna types listed in the user guide with the maximum permissible gain and required antenna impedance for each antenna type indicated. Antenna types not included in this list, having a gain greater than the maximum gain indicated for that type, are strictly prohibited for use with this device.

Concernant les EVMs avec antennes détachables

Conformément à la réglementation d'Industrie Canada, le présent émetteur radio peut fonctionner avec une antenne d'un type et d'un gain maximal (ou inférieur) approuvé pour l'émetteur par Industrie Canada. Dans le but de réduire les risques de brouillage radioélectrique à l'intention des autres utilisateurs, il faut choisir le type d'antenne et son gain de sorte que la puissance isotrope rayonnée équivalente (p.i.r.e.) ne dépasse pas l'intensité nécessaire à l'établissement d'une communication satisfaisante. Le présent émetteur radio a été approuvé par Industrie Canada pour fonctionner avec les types d'antenne énumérés dans le manuel d'usage et ayant un gain admissible maximal et l'impédance requise pour chaque type d'antenne. Les types d'antenne non inclus dans cette liste, ou dont le gain est supérieur au gain maximal indiqué, sont strictement interdits pour l'exploitation de l'émetteur.

3.3 Japan

3.3.1 *Notice for EVMs delivered in Japan:* Please see http://www.tij.co.jp/lstds/ti_ja/general/eStore/notice_01.page 日本国内に輸入される評価用キット、ボードについては、次のところをご覧ください。
http://www.tij.co.jp/lstds/ti_ja/general/eStore/notice_01.page

3.3.2 *Notice for Users of EVMs Considered "Radio Frequency Products" in Japan:* EVMs entering Japan may not be certified by TI as conforming to Technical Regulations of Radio Law of Japan.

If User uses EVMs in Japan, not certified to Technical Regulations of Radio Law of Japan, User is required to follow the instructions set forth by Radio Law of Japan, which includes, but is not limited to, the instructions below with respect to EVMs (which for the avoidance of doubt are stated strictly for convenience and should be verified by User):

1. Use EVMs in a shielded room or any other test facility as defined in the notification #173 issued by Ministry of Internal Affairs and Communications on March 28, 2006, based on Sub-section 1.1 of Article 6 of the Ministry's Rule for Enforcement of Radio Law of Japan,
2. Use EVMs only after User obtains the license of Test Radio Station as provided in Radio Law of Japan with respect to EVMs, or
3. Use of EVMs only after User obtains the Technical Regulations Conformity Certification as provided in Radio Law of Japan with respect to EVMs. Also, do not transfer EVMs, unless User gives the same notice above to the transferee. Please note that if User does not follow the instructions above, User will be subject to penalties of Radio Law of Japan.

【無線電波を送信する製品の開発キットをお使いになる際の注意事項】 開発キットの中には技術基準適合証明を受けていないものがあります。技術適合証明を受けていないものご使用に際しては、電波法遵守のため、以下のいずれかの措置を取っていただく必要がありますのでご注意ください。

1. 電波法施行規則第6条第1項第1号に基づく平成18年3月28日総務省告示第173号で定められた電波暗室等の試験設備でご使用いただく。
2. 実験局の免許を取得後ご使用いただく。
3. 技術基準適合証明を取得後ご使用いただく。

なお、本製品は、上記の「ご使用にあたっての注意」を譲渡先、移転先に通知しない限り、譲渡、移転できないものとします。

上記を遵守頂けない場合は、電波法の罰則が適用される可能性があることをご留意ください。日本テキサス・インスツルメンツ株式会社
東京都新宿区西新宿 6 丁目 2 4 番 1 号
西新宿三井ビル

3.3.3 *Notice for EVMs for Power Line Communication:* Please see http://www.tij.co.jp/lstds/ti_ja/general/eStore/notice_02.page
電力線搬送波通信についての開発キットをお使いになる際の注意事項については、次のところをご覧ください。http://www.tij.co.jp/lstds/ti_ja/general/eStore/notice_02.page

3.4 European Union

3.4.1 *For EVMs subject to EU Directive 2014/30/EU (Electromagnetic Compatibility Directive):*

This is a class A product intended for use in environments other than domestic environments that are connected to a low-voltage power-supply network that supplies buildings used for domestic purposes. In a domestic environment this product may cause radio interference in which case the user may be required to take adequate measures.

4 *EVM Use Restrictions and Warnings:*

4.1 EVMS ARE NOT FOR USE IN FUNCTIONAL SAFETY AND/OR SAFETY CRITICAL EVALUATIONS, INCLUDING BUT NOT LIMITED TO EVALUATIONS OF LIFE SUPPORT APPLICATIONS.

4.2 User must read and apply the user guide and other available documentation provided by TI regarding the EVM prior to handling or using the EVM, including without limitation any warning or restriction notices. The notices contain important safety information related to, for example, temperatures and voltages.

4.3 *Safety-Related Warnings and Restrictions:*

4.3.1 User shall operate the EVM within TI's recommended specifications and environmental considerations stated in the user guide, other available documentation provided by TI, and any other applicable requirements and employ reasonable and customary safeguards. Exceeding the specified performance ratings and specifications (including but not limited to input and output voltage, current, power, and environmental ranges) for the EVM may cause personal injury or death, or property damage. If there are questions concerning performance ratings and specifications, User should contact a TI field representative prior to connecting interface electronics including input power and intended loads. Any loads applied outside of the specified output range may also result in unintended and/or inaccurate operation and/or possible permanent damage to the EVM and/or interface electronics. Please consult the EVM user guide prior to connecting any load to the EVM output. If there is uncertainty as to the load specification, please contact a TI field representative. During normal operation, even with the inputs and outputs kept within the specified allowable ranges, some circuit components may have elevated case temperatures. These components include but are not limited to linear regulators, switching transistors, pass transistors, current sense resistors, and heat sinks, which can be identified using the information in the associated documentation. When working with the EVM, please be aware that the EVM may become very warm.

4.3.2 EVMs are intended solely for use by technically qualified, professional electronics experts who are familiar with the dangers and application risks associated with handling electrical mechanical components, systems, and subsystems. User assumes all responsibility and liability for proper and safe handling and use of the EVM by User or its employees, affiliates, contractors or designees. User assumes all responsibility and liability to ensure that any interfaces (electronic and/or mechanical) between the EVM and any human body are designed with suitable isolation and means to safely limit accessible leakage currents to minimize the risk of electrical shock hazard. User assumes all responsibility and liability for any improper or unsafe handling or use of the EVM by User or its employees, affiliates, contractors or designees.

4.4 User assumes all responsibility and liability to determine whether the EVM is subject to any applicable international, federal, state, or local laws and regulations related to User's handling and use of the EVM and, if applicable, User assumes all responsibility and liability for compliance in all respects with such laws and regulations. User assumes all responsibility and liability for proper disposal and recycling of the EVM consistent with all applicable international, federal, state, and local requirements.

5. *Accuracy of Information:* To the extent TI provides information on the availability and function of EVMs, TI attempts to be as accurate as possible. However, TI does not warrant the accuracy of EVM descriptions, EVM availability or other information on its websites as accurate, complete, reliable, current, or error-free.

6. *Disclaimers:*

6.1 EXCEPT AS SET FORTH ABOVE, EVMS AND ANY MATERIALS PROVIDED WITH THE EVM (INCLUDING, BUT NOT LIMITED TO, REFERENCE DESIGNS AND THE DESIGN OF THE EVM ITSELF) ARE PROVIDED "AS IS" AND "WITH ALL FAULTS." TI DISCLAIMS ALL OTHER WARRANTIES, EXPRESS OR IMPLIED, REGARDING SUCH ITEMS, INCLUDING BUT NOT LIMITED TO ANY EPIDEMIC FAILURE WARRANTY OR IMPLIED WARRANTIES OF MERCHANTABILITY OR FITNESS FOR A PARTICULAR PURPOSE OR NON-INFRINGEMENT OF ANY THIRD PARTY PATENTS, COPYRIGHTS, TRADE SECRETS OR OTHER INTELLECTUAL PROPERTY RIGHTS.

6.2 EXCEPT FOR THE LIMITED RIGHT TO USE THE EVM SET FORTH HEREIN, NOTHING IN THESE TERMS SHALL BE CONSTRUED AS GRANTING OR CONFERRING ANY RIGHTS BY LICENSE, PATENT, OR ANY OTHER INDUSTRIAL OR INTELLECTUAL PROPERTY RIGHT OF TI, ITS SUPPLIERS/LICENSORS OR ANY OTHER THIRD PARTY, TO USE THE EVM IN ANY FINISHED END-USER OR READY-TO-USE FINAL PRODUCT, OR FOR ANY INVENTION, DISCOVERY OR IMPROVEMENT, REGARDLESS OF WHEN MADE, CONCEIVED OR ACQUIRED.

7. *USER'S INDEMNITY OBLIGATIONS AND REPRESENTATIONS.* USER WILL DEFEND, INDEMNIFY AND HOLD TI, ITS LICENSORS AND THEIR REPRESENTATIVES HARMLESS FROM AND AGAINST ANY AND ALL CLAIMS, DAMAGES, LOSSES, EXPENSES, COSTS AND LIABILITIES (COLLECTIVELY, "CLAIMS") ARISING OUT OF OR IN CONNECTION WITH ANY HANDLING OR USE OF THE EVM THAT IS NOT IN ACCORDANCE WITH THESE TERMS. THIS OBLIGATION SHALL APPLY WHETHER CLAIMS ARISE UNDER STATUTE, REGULATION, OR THE LAW OF TORT, CONTRACT OR ANY OTHER LEGAL THEORY, AND EVEN IF THE EVM FAILS TO PERFORM AS DESCRIBED OR EXPECTED.

8. *Limitations on Damages and Liability:*

8.1 *General Limitations.* IN NO EVENT SHALL TI BE LIABLE FOR ANY SPECIAL, COLLATERAL, INDIRECT, PUNITIVE, INCIDENTAL, CONSEQUENTIAL, OR EXEMPLARY DAMAGES IN CONNECTION WITH OR ARISING OUT OF THESE TERMS OR THE USE OF THE EVMS , REGARDLESS OF WHETHER TI HAS BEEN ADVISED OF THE POSSIBILITY OF SUCH DAMAGES. EXCLUDED DAMAGES INCLUDE, BUT ARE NOT LIMITED TO, COST OF REMOVAL OR REINSTALLATION, ANCILLARY COSTS TO THE PROCUREMENT OF SUBSTITUTE GOODS OR SERVICES, RETESTING, OUTSIDE COMPUTER TIME, LABOR COSTS, LOSS OF GOODWILL, LOSS OF PROFITS, LOSS OF SAVINGS, LOSS OF USE, LOSS OF DATA, OR BUSINESS INTERRUPTION. NO CLAIM, SUIT OR ACTION SHALL BE BROUGHT AGAINST TI MORE THAN TWELVE (12) MONTHS AFTER THE EVENT THAT GAVE RISE TO THE CAUSE OF ACTION HAS OCCURRED.

8.2 *Specific Limitations.* IN NO EVENT SHALL TI'S AGGREGATE LIABILITY FROM ANY USE OF AN EVM PROVIDED HEREUNDER, INCLUDING FROM ANY WARRANTY, INDEMNITY OR OTHER OBLIGATION ARISING OUT OF OR IN CONNECTION WITH THESE TERMS, , EXCEED THE TOTAL AMOUNT PAID TO TI BY USER FOR THE PARTICULAR EVM(S) AT ISSUE DURING THE PRIOR TWELVE (12) MONTHS WITH RESPECT TO WHICH LOSSES OR DAMAGES ARE CLAIMED. THE EXISTENCE OF MORE THAN ONE CLAIM SHALL NOT ENLARGE OR EXTEND THIS LIMIT.

9. *Return Policy.* Except as otherwise provided, TI does not offer any refunds, returns, or exchanges. Furthermore, no return of EVM(s) will be accepted if the package has been opened and no return of the EVM(s) will be accepted if they are damaged or otherwise not in a resalable condition. If User feels it has been incorrectly charged for the EVM(s) it ordered or that delivery violates the applicable order, User should contact TI. All refunds will be made in full within thirty (30) working days from the return of the components(s), excluding any postage or packaging costs.

10. *Governing Law:* These terms and conditions shall be governed by and interpreted in accordance with the laws of the State of Texas, without reference to conflict-of-laws principles. User agrees that non-exclusive jurisdiction for any dispute arising out of or relating to these terms and conditions lies within courts located in the State of Texas and consents to venue in Dallas County, Texas. Notwithstanding the foregoing, any judgment may be enforced in any United States or foreign court, and TI may seek injunctive relief in any United States or foreign court.

Mailing Address: Texas Instruments, Post Office Box 655303, Dallas, Texas 75265
Copyright © 2019, Texas Instruments Incorporated

IMPORTANT NOTICE AND DISCLAIMER

TI PROVIDES TECHNICAL AND RELIABILITY DATA (INCLUDING DATA SHEETS), DESIGN RESOURCES (INCLUDING REFERENCE DESIGNS), APPLICATION OR OTHER DESIGN ADVICE, WEB TOOLS, SAFETY INFORMATION, AND OTHER RESOURCES "AS IS" AND WITH ALL FAULTS, AND DISCLAIMS ALL WARRANTIES, EXPRESS AND IMPLIED, INCLUDING WITHOUT LIMITATION ANY IMPLIED WARRANTIES OF MERCHANTABILITY, FITNESS FOR A PARTICULAR PURPOSE OR NON-INFRINGEMENT OF THIRD PARTY INTELLECTUAL PROPERTY RIGHTS.

These resources are intended for skilled developers designing with TI products. You are solely responsible for (1) selecting the appropriate TI products for your application, (2) designing, validating and testing your application, and (3) ensuring your application meets applicable standards, and any other safety, security, regulatory or other requirements.

These resources are subject to change without notice. TI grants you permission to use these resources only for development of an application that uses the TI products described in the resource. Other reproduction and display of these resources is prohibited. No license is granted to any other TI intellectual property right or to any third party intellectual property right. TI disclaims responsibility for, and you will fully indemnify TI and its representatives against, any claims, damages, costs, losses, and liabilities arising out of your use of these resources.

TI's products are provided subject to [TI's Terms of Sale](#) or other applicable terms available either on ti.com or provided in conjunction with such TI products. TI's provision of these resources does not expand or otherwise alter TI's applicable warranties or warranty disclaimers for TI products.

TI objects to and rejects any additional or different terms you may have proposed.

Mailing Address: Texas Instruments, Post Office Box 655303, Dallas, Texas 75265
Copyright © 2022, Texas Instruments Incorporated