

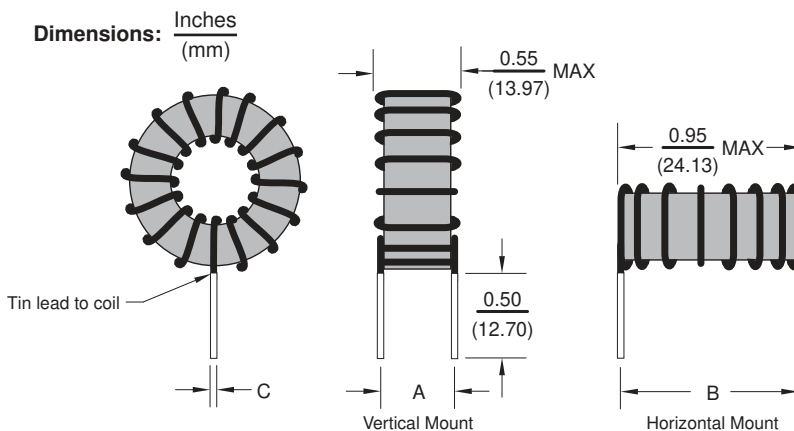

Toroid Chokes

TC220

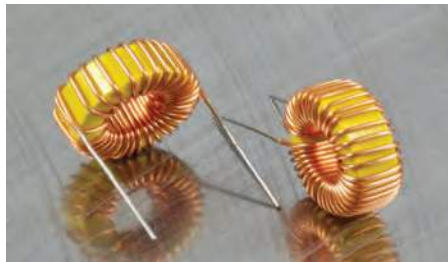

Allied Part Number	L(μH) @15% 1 KHZ	Tolerance (%)	L(μH) ±15% @I rated	IDC (A)	DCR (Ω) MAX	DIM A (Nom)	DIM B (Nom)	DIM C (Nom)
()TC220-100L-RC	10	15	6.7	12.5	.007	.46	.88	.053
()TC220-120L-RC	12	15	7.9	12.0	.008	.46	.88	.053
()TC220-150L-RC	15	15	9.6	11.3	.008	.46	.88	.053
()TC220-180L-RC	18	15	11.3	10.8	.009	.46	.88	.053
()TC220-220L-RC	22	15	13.4	10.3	.010	.46	.88	.053
()TC220-270L-RC	27	15	16.0	9.8	.011	.46	.88	.053
()TC220-330L-RC	33	15	21.6	7.4	.020	.45	.87	.042
()TC220-390L-RC	39	15	25.0	7.1	.022	.45	.87	.042
()TC220-470L-RC	47	15	29.3	6.7	.024	.45	.87	.042
()TC220-560L-RC	56	15	34.1	6.4	.026	.45	.87	.042
()TC220-680L-RC	68	15	45.7	4.9	.046	.44	.86	.034
()TC220-101L-RC	100	15	64.0	4.4	.056	.44	.86	.034
()TC220-121L-RC	120	15	84.4	3.3	.098	.44	.86	.027
()TC220-151L-RC	150	15	102.7	3.1	.110	.44	.86	.027
()TC220-181L-RC	180	15	105.9	3.8	.075	.48	.90	.034
()TC220-221L-RC	220	15	125.6	3.6	.083	.48	.90	.034
()TC220-271L-RC	270	15	149.4	3.4	.092	.48	.90	.034
()TC220-331L-RC	330	15	176.8	3.3	.100	.48	.90	.034
()TC220-391L-RC	390	15	235.3	2.5	.180	.46	.88	.027
()TC220-471L-RC	470	15	275.9	2.3	.190	.46	.88	.027
()TC220-561L-RC	560	15	320.1	2.2	.210	.46	.88	.027
()TC220-681L-RC	680	15	377.2	2.1	.230	.49	.91	.027
()TC220-821L-RC	820	15	441.5	2.0	.260	.49	.91	.027
()TC220-102L-RC	1000	15	521.3	1.9	.280	.49	.91	.027

Please specify Vertical or Horizontal Mount by placing a V or H at the beginning of the part number, i.e. VTC220-100L (Vertical Mount). All specifications subject to change without notice.

Features

- Low Magnetic Radiation
- Low Core Loss
- High current capacity up to 12.5 Amps
- Available in Horizontal or Vertical configuration

Electrical

Inductance Range: 10μh to 1000μh

Additional values available

Tolerance: 15% over entire range

Test Frequency: 1KHz

Operating Temp: -55°C ~ +125°C

Temp Rise: ΔT=30°C Typical at rated IDC

Test Equipment

(L): 100 LCR meter or equivalent

DCR: Chen Hwa 502

Physical

Packaging: Bulk

Marking: None