











A close-up photograph of a CNC lathe machining a metal part. The tool is cutting a cylindrical component, and a large amount of coolant is being sprayed onto the workpiece. The machine's structure is visible, including the tool holder and the workpiece. The background is blurred, focusing attention on the machining process.

C 091 A

- M16 size
- Screw locking according to IEC 61076-2-106
- Metal locking ring
- Shieldable
- 2 - 8, 12 and 14 positions for crimp and solder
- IP 40
- Internal strain relief
- Male and female cable connectors straight and angled
- Male and female receptacles for front and rear panel mounting and PCB mounting
- Coloured back shells optional
- UL registered under file number E 63 093 UL

C 091 A Characteristics

General Characteristics	Standard	Characteristics											
Number of contacts		2 ¹⁾ + 3	4	5	5 Stereo	6	7	7	8	12	14		
View on termination side of male contact insert													
Contact arrangement	DIN EN 61076-2-106	03-a ✓	04-a ✓	05-a ✓	05-b ✓	06-a ✓	07-a ✓	07-b ✓	08-a ✓	12-a ✓	14-a ✓		
Contact arrangement	IEC 60130-9 ²⁾	✓	✓		✓	✓		✓	✓				
Electrical Characteristics													
Rated voltage ³⁾	IEC 60664-1	300 V ≈ (100 V ≈)		300 V ≈ (63 V ≈)		100 V ≈ (32 V ≈)		300 V ≈ (63 V ≈)		100 V ≈ (32 V ≈)		150 V ≈ (32 V ≈)	
Rated voltage	UL 1977	250 V									60 V		
Rated impulse withstand voltage ³⁾	IEC 60664-1	1500 V (840 V)			1200 V (500 V)		1500 V (840 V)			1200 V (500 V)			
Pollution degree ³⁾	IEC 60664-1	1 (2)											
Installation category	IEC 60664-1	I											
Insulation group	IEC 60664-1	II, 400 ≤ CTI < 600											
Current rating	IEC 60512-5-2 UL 1977	10 A / + 40 °C				7 A / + 40 °C					3 A / + 40 °C / + 104 °F		
Insulation resistance	IEC 60512-3-1	> 10 ¹⁰ Ω ⁴⁾											
Contact resistance	IEC 60512-2-1	< 5 m Ω											
Climatic Characteristics													
Climatic category	IEC 60068-1	40 / 100 / 56											
Temperature range	IEC 60068-1	- 40 °C ... + 100 °C / - 40 °F ... + 212 °F											
Mechanical Characteristics													
IP-degree	IEC 60529	IP 40											
Insertion and withdrawal forces	IEC 60512-13-2	25 N 90.oz	30 N 110.oz	35 N 125.oz	50 N 180.oz	55 N 200.oz	60 N 220.oz	50 N 180.oz					
Mechanical operation	IEC 60512-9-1	Silver ≥ 500 mating cycles Gold ≥ 1000 mating cycles											
Materials													
Housing material		brass or zinc die cast nickel plated or thermoplast											
Dielectric material		thermoplastic											
Contact plating		silver plated / gold plated ⁵⁾											
Further Characteristics													
Termination technique		solder, crimp											
Wire gauge		solder: ≤ 0,5 mm ² / 20 AWG crimp: 2 - 6 pol (excluding 5S): 0,09 - 1,00 mm ² / 28 - 18 AWG crimp: 5S, 7, 7S and 8-pol.: 0,09 - 0,75 mm ² / 28 - 20 AWG								solder: ≤ 0,25 mm ² / 24 AWG crimp: 0,09-0,25 mm ² / 28 - 24 AWG			
Flammability		UL 94 V0											
Locking system	IEC 60130-9 DIN EN 61076-2-106	metal screw coupling; tightening torque 0,7 Nm											

Caution: Do not connect or disconnect under load. Metal housing parts shall be securely incorporated to protected ground.

¹⁾ 2 contact version: contact loading 1+3

²⁾ Edition 2000-05









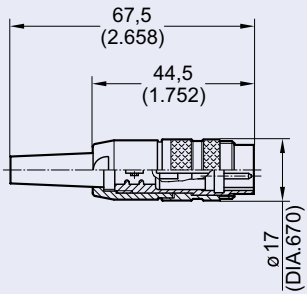

³⁾ Values in brackets are according to DIN EN 61076-2-106

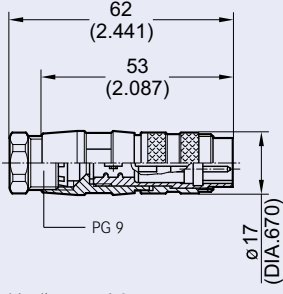
⁴⁾ Under operating conditions >10⁸ Ω

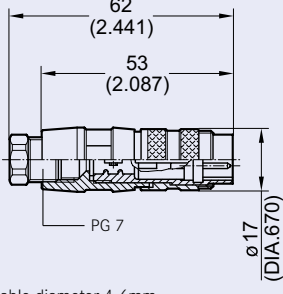
⁵⁾ Remark for gold plated contacts: In order to avoid brittle inter-metallic connections, gold-plated terminals have to be tin-plated in the solder area.

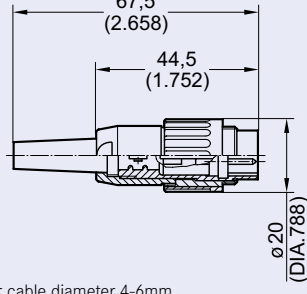
IEC 60 664 ≙ DIN VDE 0110; IEC 60 512-x ≙ DIN EN 60 512-x; IEC 60 130-9 ≙ DIN EN 60 130-9; IEC 61076-2-106 ≙ DIN EN 61076-2-106

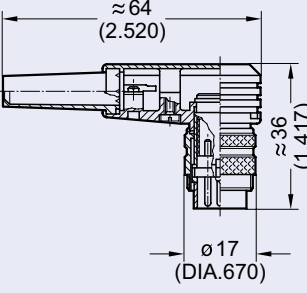
C 091 A Male cable connector

No. of cont.	Part Number solder termination		Part Number crimp termination	Drawing	Figure		
	silver plating	gold plating ¹⁾					
Straight (Please order crimp contacts separately, see page 56)							
2	T 3200 001	T 3200 018	T 3200 551	 <p>for cable diameter 4-6mm</p>			
3	T 3260 001	T 3260 018	T 3260 551				
4	T 3300 001	T 3300 018	T 3300 551				
5	T 3360 001	T 3360 018	T 3360 551				
5S ²⁾	T 3360 010	T 3356 018	T 3356 551				
6	T 3400 001	T 3400 018	T 3400 551				
7	T 3475 001	T 3475 018	T 3475 551				
7 ²⁾	T 3484 001	T 3484 018	T 3484 551				
8	T 3504 001	T 3504 018	T 3504 551				
12	T 3635 001	T 3635 000	T 3635 551				
14	T 3650 001	T 3650 000	T 3650 551				
2	T 3200 002	T 3200 028	T 3200 552			 <p>for cable diameter 6-8mm</p>	
3	T 3260 002	T 3260 028	T 3260 552				
4	T 3300 002	T 3300 028	T 3300 552				
5	T 3360 002	T 3360 028	T 3360 552				
5S ²⁾	T 3360 020	T 3356 028	T 3356 552				
6	T 3400 002	T 3400 028	T 3400 552				
7	T 3475 002	T 3475 028	T 3475 552				
7 ²⁾	T 3484 002	T 3484 028	T 3484 552				
8	T 3504 002	T 3504 028	T 3504 552				
12	T 3635 020	T 3635 002	T 3635 552				
14	T 3650 020	T 3650 002	T 3650 552				
2	T 3200 004	T 3200 048	T 3200 554	 <p>for cable diameter 4-6mm</p>			
3	T 3260 004	T 3260 048	T 3260 554				
4	T 3300 004	T 3300 048	T 3300 554				
5	T 3360 004	T 3360 048	T 3360 554				
5S ²⁾	T 3356 004	T 3356 048	T 3356 554				
6	T 3400 004	T 3400 048	T 3400 554				
7	T 3475 004	T 3475 048	T 3475 554				
7 ²⁾	T 3484 004	T 3484 048	T 3484 554				
8	T 3504 004	T 3504 048	T 3504 554				
12	T 3635 024	T 3635 004	T 3635 554				
14	T 3650 024	T 3650 004	T 3650 554				
2	T 3200 013	T 3200 038	T 3200 556			 <p>for cable diameter 4-6mm</p>	
3	T 3260 013	T 3260 038	T 3260 556				
4	T 3300 013	T 3300 038	T 3300 556				
5	T 3360 013	T 3360 038	T 3360 556				
5S ²⁾	T 3360 130	T 3356 038	T 3356 556				
6	T 3400 013	T 3400 038	T 3400 556				
7	T 3475 013	T 3475 038	T 3475 556				
7 ²⁾	T 3484 013	T 3484 038	T 3484 556				
8	T 3504 013	T 3504 038	T 3504 556				
12	T 3635 013	T 3635 038	T 3635 556				
14	T 3650 013	T 3650 038	T 3650 556				
Right-angled (Please order crimp contacts separately, see page 56)							
2	T 3200 005	T 3200 058	T 3200 055	 <p>for cable diameter 4-6mm</p>			
3	T 3260 005	T 3260 058	T 3260 055				
4	T 3300 005	T 3300 058	T 3300 055				
5	T 3360 005	T 3360 058	T 3360 055				
5S ²⁾	T 3356 005	T 3356 058	T 3356 055				
6	T 3400 005	T 3400 058	T 3400 055				
7	T 3475 005	T 3475 058	T 3475 055				
7 ²⁾	T 3484 005	T 3484 058	T 3484 055				
8	T 3504 005	T 3504 058	T 3504 055				
12	T 3635 005	T 3635 058	T 3635 055				
14	T 3650 005	T 3650 058	T 3650 055				

C 091 A Male cable connector

Assembly instruction¹⁾, cable diameter 4-6mm

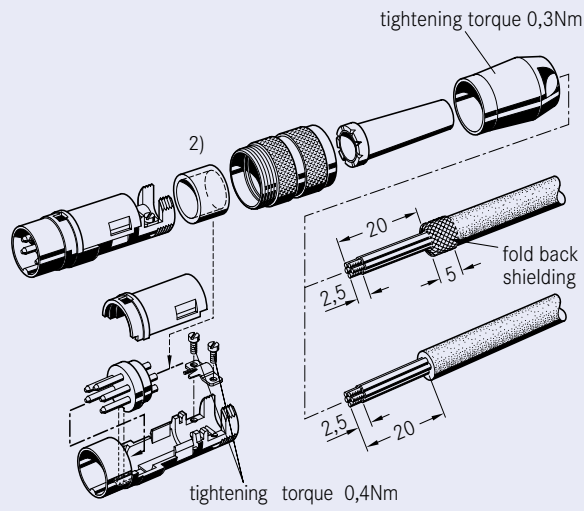



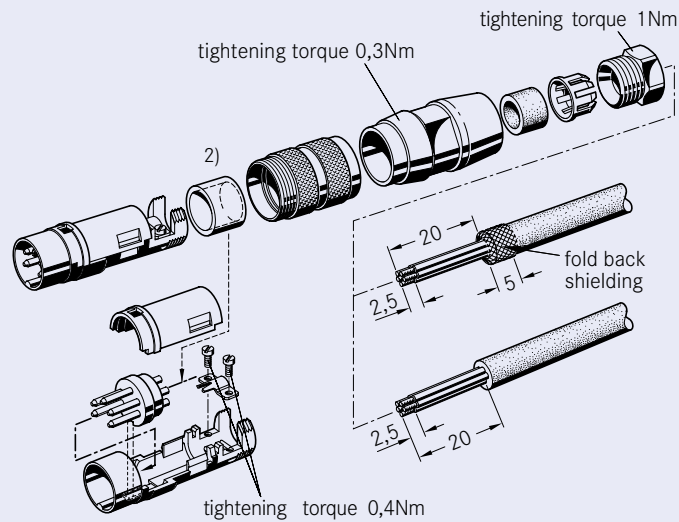



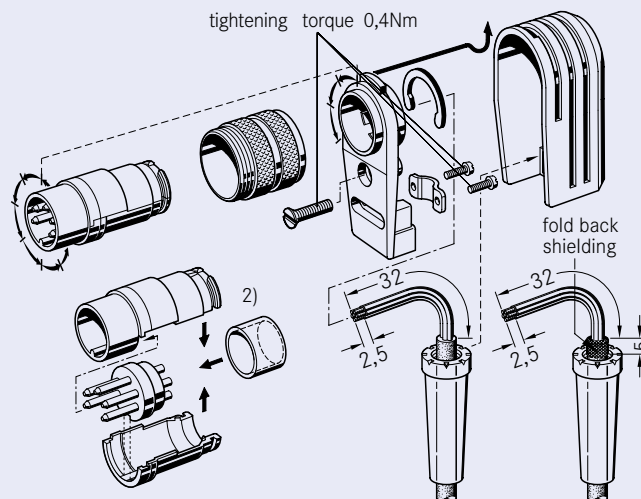

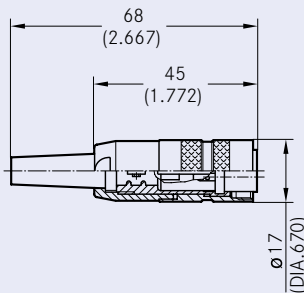

Assembly instruction¹⁾, cable diameter 4-6mm or 6-8mm

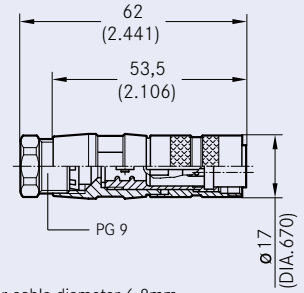

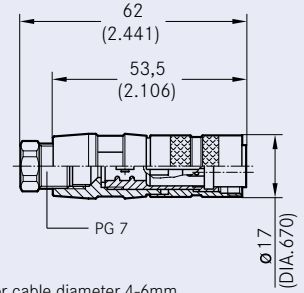
Assembly instruction¹⁾, right-angled, can be keyed to 8 angle positions

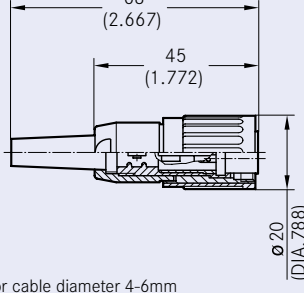

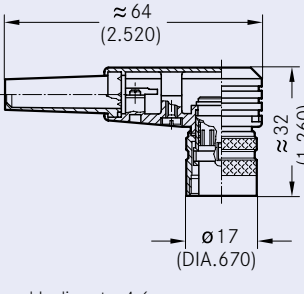
C 091 A Female cable connector

No. of cont.	Part Number solder termination		Part Number crimp termination	Drawing	Figure		
	silver plating	gold plating ¹⁾					
Straight (Please order crimp contacts separately, see page 56)							
2	T 3201 001	T 3201 018	T 3201 551	 <p>for cable diameter 4-6mm</p>			
3	T 3261 001	T 3261 018	T 3261 551				
4	T 3301 001	T 3301 018	T 3301 551				
5	T 3361 001	T 3361 018	T 3361 551				
5S ²⁾	T 3361 010	T 3357 018	T 3357 551				
6	T 3401 001	T 3401 018	T 3401 551				
7	T 3476 001	T 3476 018	T 3476 551				
7 ²⁾	T 3485 001	T 3485 018	T 3485 551				
8	T 3505 001	T 3505 018	T 3505 551				
12	T 3636 001	T 3636 000	T 3636 551				
14	T 3651 001	T 3651 000	T 3651 551				
2	T 3201 002	T 3201 028	T 3201 552			 <p>for cable diameter 6-8mm</p>	
3	T 3261 002	T 3261 028	T 3261 552				
4	T 3301 002	T 3301 028	T 3301 552				
5	T 3361 002	T 3361 028	T 3361 552				
5S ²⁾	T 3361 020	T 3357 028	T 3357 552				
6	T 3401 002	T 3401 028	T 3401 552				
7	T 3476 002	T 3476 028	T 3476 552				
7 ²⁾	T 3485 002	T 3485 028	T 3485 552				
8	T 3505 002	T 3505 028	T 3505 552				
12	T 3636 020	T 3636 002	T 3636 552				
14	T 3651 020	T 3651 002	T 3651 552				
2	T 3201 004	T 3201 048	T 3201 554	 <p>for cable diameter 4-6mm</p>			
3	T 3261 004	T 3261 048	T 3261 554				
4	T 3301 004	T 3301 048	T 3301 554				
5	T 3361 004	T 3361 048	T 3361 554				
5S ²⁾	T 3357 004	T 3357 048	T 3357 554				
6	T 3401 004	T 3401 048	T 3401 554				
7	T 3476 004	T 3476 048	T 3476 554				
7 ²⁾	T 3485 004	T 3485 048	T 3485 554				
8	T 3505 004	T 3505 048	T 3505 554				
12	T 3636 044	T 3636 004	T 3636 554				
14	T 3651 044	T 3651 004	T 3651 554				
2	T 3201 013	T 3201 038	T 3201 556			 <p>for cable diameter 4-6mm</p>	
3	T 3261 013	T 3261 038	T 3261 556				
4	T 3301 013	T 3301 038	T 3301 556				
5	T 3361 013	T 3361 038	T 3361 556				
5S ²⁾	T 3361 130	T 3357 038	T 3357 556				
6	T 3401 013	T 3401 038	T 3401 556				
7	T 3476 013	T 3476 038	T 3476 556				
7 ²⁾	T 3485 013	T 3485 038	T 3485 556				
8	T 3505 013	T 3505 038	T 3505 556				
12	T 3636 013	T 3636 038	T 3636 556				
14	T 3651 013	T 3651 038	T 3651 556				
Right-angled (Please order crimp contacts separately, see page 56)							
2	T 3201 005	T 3201 058	T 3201 055	 <p>for cable diameter 4-6mm</p>			
3	T 3261 005	T 3261 058	T 3261 055				
4	T 3301 005	T 3301 058	T 3301 055				
5	T 3361 005	T 3361 058	T 3361 055				
5S ²⁾	T 3357 005	T 3357 058	T 3357 055				
6	T 3401 005	T 3401 058	T 3401 055				
7	T 3476 005	T 3476 058	T 3476 055				
7 ²⁾	T 3485 005	T 3485 058	T 3485 055				
8	T 3505 005	T 3505 058	T 3505 055				
12	T 3636 005	T 3636 058	T 3636 055				
14	T 3651 005	T 3651 058	T 3651 055				

C 091 A Female cable connector

Assembly instruction¹⁾, cable diameter 4-6mm

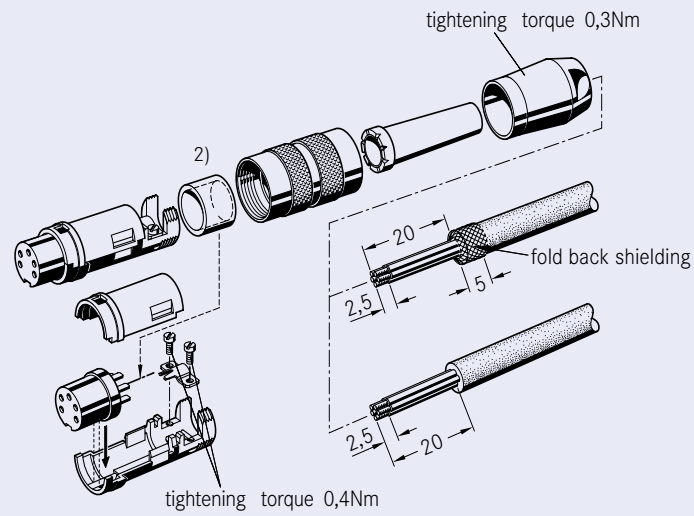

Assembly instruction¹⁾, cable diameter 4-6mm or 6-8mm

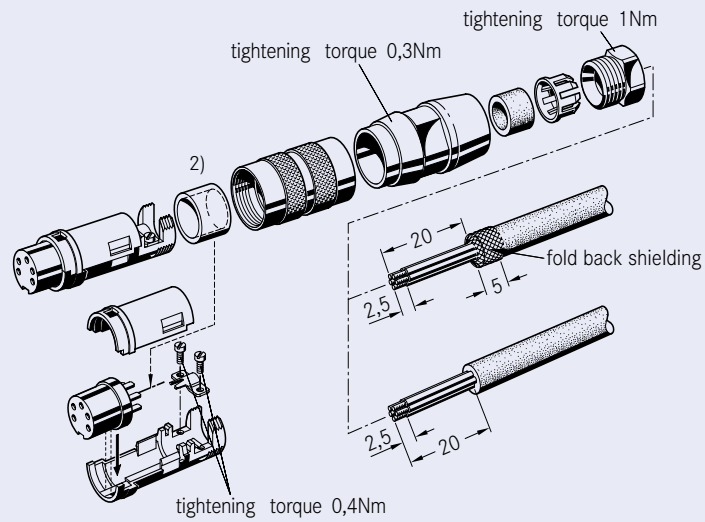

Assembly instruction¹⁾, right-angled, can be keyed to 8 angle positions

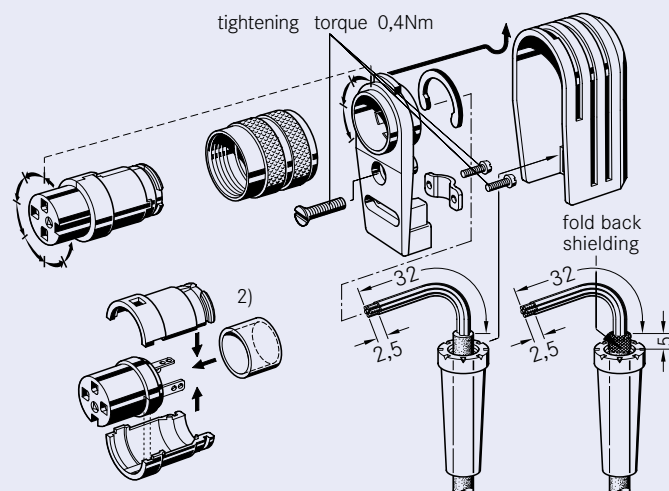

C 091 A Male receptacle | front mounting

No. of cont.	Part Number		Part Number crimp termination	Drawing	Figure
	silver plating	gold plating ¹⁾			

Ring Nut (Hex nut on request) (Please order crimp contacts separately, see page 56)

2	T 3202 000	T 3202 018	T 3202 550
3	T 3262 000	T 3262 018	T 3262 550
4	T 3302 000	T 3302 018	T 3302 550
5	T 3362 000	T 3362 018	T 3362 550
5S ²⁾	T 3362 010	T 3358 018	T 3358 550
6	T 3402 000	T 3402 018	T 3402 550
7	T 3477 000	T 3477 018	T 3477 550
7 ²⁾	T 3486 000	T 3486 018	T 3486 550
8	T 3506 000	T 3506 018	T 3506 550
12	T 3637 001	T 3637 000	T 3637 550
14	T 3652 001	T 3652 000	T 3652 550

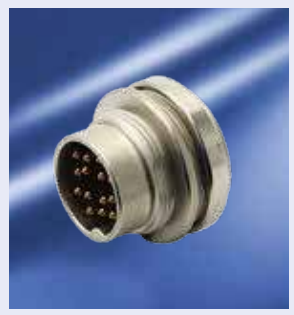
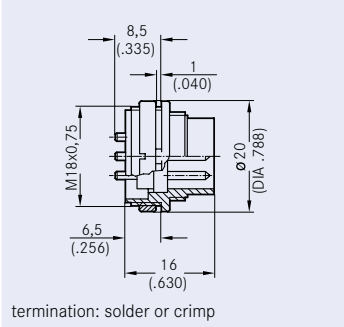

2	T 3262 300	T 3262 304	
3	T 3302 300	T 3302 304	
4	T 3362 300	T 3362 304	
5	T 3362 300	T 3362 304	
5S ²⁾	T 3358 300	T 3358 304	
6	T 3402 300	T 3402 304	
7	T 3477 300	T 3477 304	
7 ²⁾	T 3486 300	T 3486 304	
8	T 3506 300	T 3506 304	
12	T 3637 300	T 3637 304	
14	T 3652 300	T 3652 304	

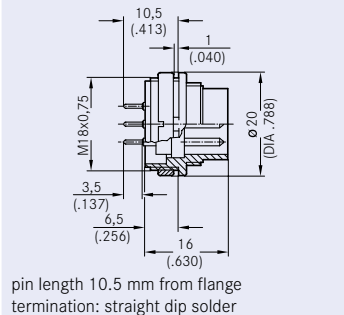

Assembly instruction ³⁾

Panel cutout

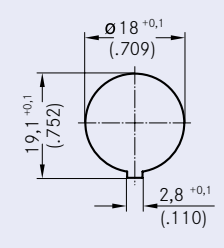
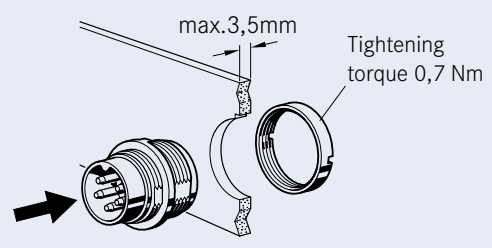

C 091 A Male receptacle | rear mounting

No. of cont.	Part Number solder termination		Part Number crimp termination	Drawing	Figure
	silver plating	gold plating ¹⁾			

Ring Nut (Hex nut on request)

(Please order crimp contacts separately, see page 56)

2	T 3202 100	T 3202 118	T 3202 150
3	T 3262 100	T 3262 118	T 3262 150
4	T 3302 100	T 3302 118	T 3302 150
5	T 3362 100	T 3362 118	T 3362 150
5S ²⁾	T 3358 100	T 3358 118	T 3358 150
6	T 3402 100	T 3402 118	T 3402 150
7	T 3477 100	T 3477 118	T 3477 150
7 ²⁾	T 3486 100	T 3486 118	T 3486 150
8	T 3506 100	T 3506 118	T 3506 150
12	T 3637 110	T 3637 100	T 3637 150
14	T 3652 110	T 3652 100	T 3652 150

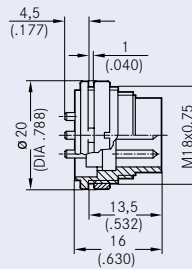

termination: solder or crimp



3	T 3262 400	T 3262 404	
4	T 3302 400	T 3302 404	
5	T 3362 400	T 3362 404	
5S ²⁾	T 3358 400	T 3358 404	
6	T 3402 400	T 3402 404	
7	T 3477 400	T 3477 404	
7 ²⁾	T 3486 400	T 3486 404	
8	T 3506 400	T 3506 404	
12	T 3637 400	T 3637 404	
14	T 3652 400	T 3652 404	

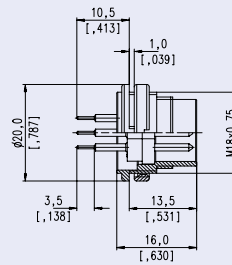

pin length 10.5 mm from flange
termination: straight dip solder



3	T 3262 420		
4	T 3302 420		
5	T 3362 420		
5S ²⁾	T 3358 420		
6	T 3402 420		
7	T 3477 420		
7 ²⁾	T 3486 420		
8	T 3506 420		
12			
14			

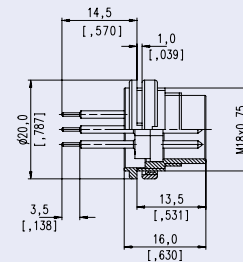

pin length 14.5 mm from flange
termination: straight dip solder



3	T 3262 430		
4	T 3302 430		
5	T 3362 430		
5S ²⁾	T 3358 430		
6	T 3402 430		
7	T 3477 430		
7 ²⁾	T 3486 430		
8	T 3506 430		
12			
14			

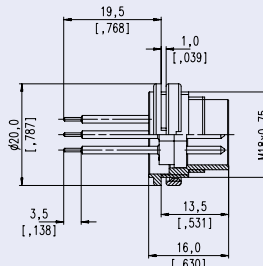

pin length 19.5 mm from flange
termination: straight dip solder



Assembly instruction³⁾

Panel cutout

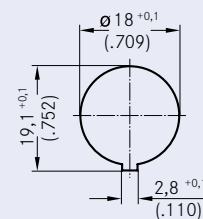
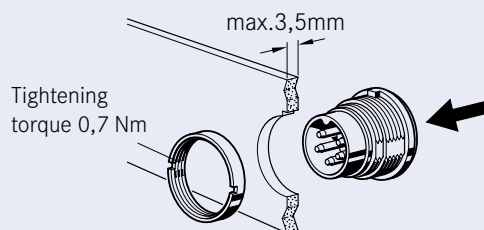

PCB-Layout (components side of circuit board)

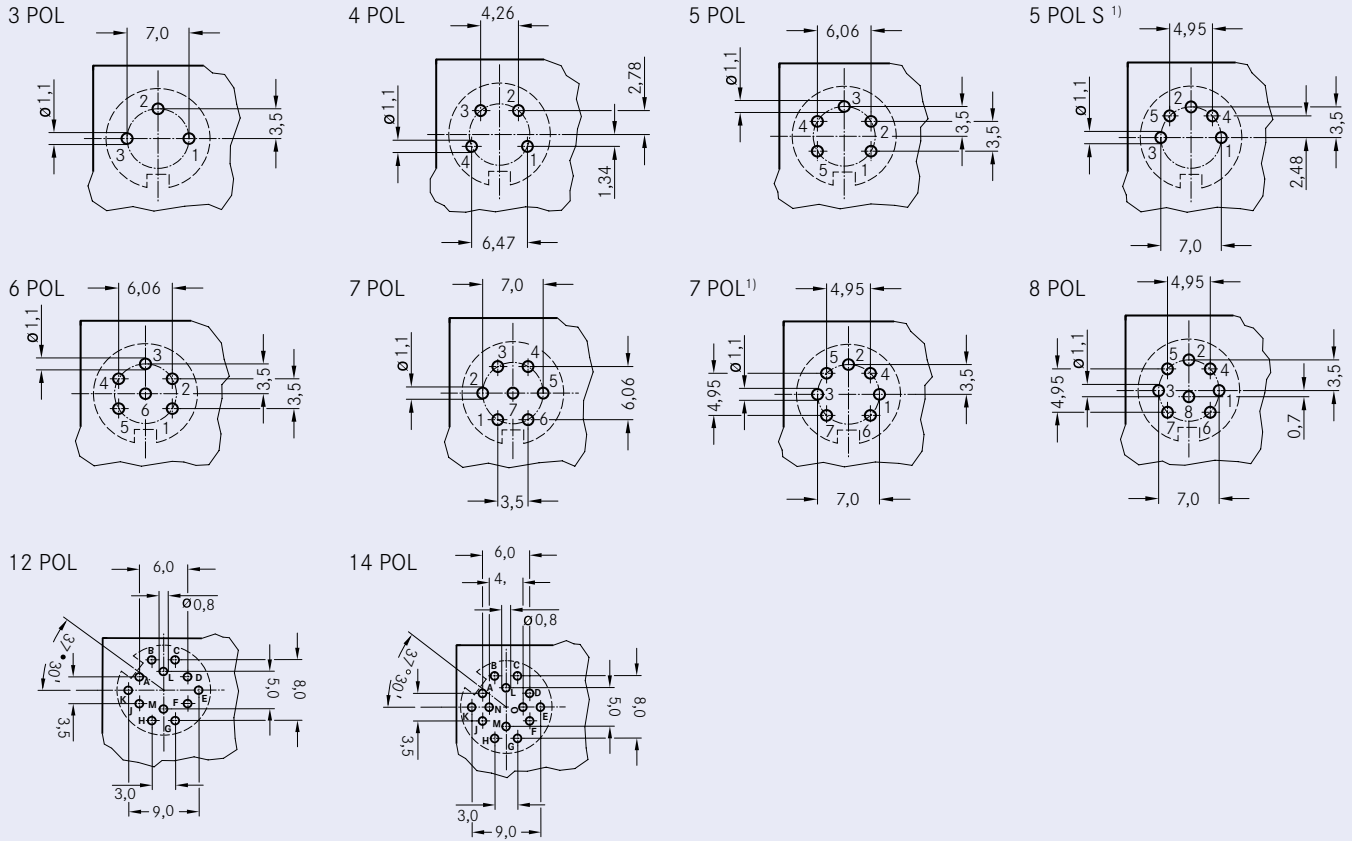

Male Receptacles | front mounting | rear mounting | straight



C 091 A Female receptacle | front mounting

No. of cont.	Part Number		Part Number crimp termination	Drawing	Figure
	solder termination silver plating	gold plating ¹⁾			

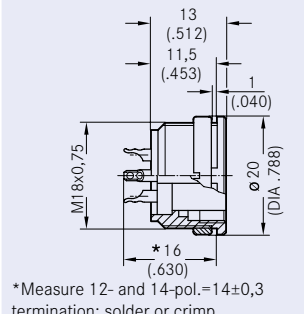
Ring Nut (Hex nut on request) (Please order crimp contacts separately, see page 56)

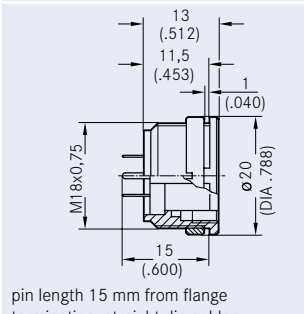
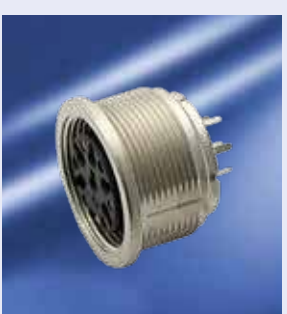
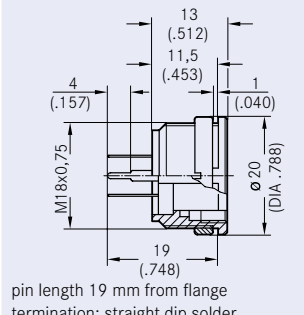
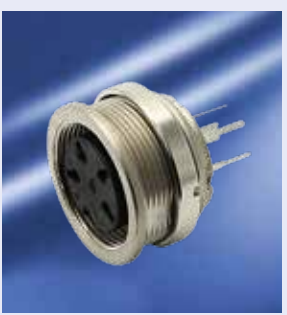
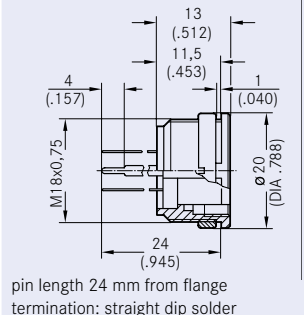
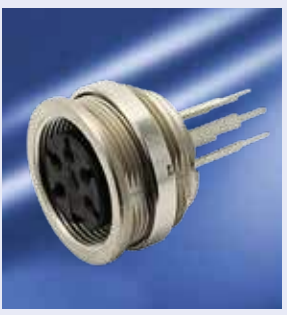
2	T 3203 000	T 3203 018	T 3203 550				
3	T 3263 000	T 3263 018	T 3263 550				
4	T 3303 000	T 3303 018	T 3303 550				
5	T 3363 000	T 3363 018	T 3363 550				
5S ²⁾	T 3363 010	T 3359 018	T 3359 550				
6	T 3403 000	T 3403 018	T 3403 550				
7	T 3478 000	T 3478 018	T 3478 550				
7 ²⁾	T 3487 000	T 3487 018	T 3487 550				
8	T 3507 000	T 3507 018	T 3507 550				
12	T 3638 000	T 3638 004	T 3638 550				
14	T 3653 000	T 3653 004	T 3653 550				
2	T 3203 300	T 3203 304					
3	T 3263 300	T 3263 304					
4	T 3303 300	T 3303 304					
5	T 3363 300	T 3363 304					
5S ²⁾	T 3359 300	T 3359 304					
6	T 3403 300	T 3403 304					
7	T 3478 300	T 3478 304					
7 ²⁾	T 3487 300	T 3487 304					
8	T 3507 300	T 3507 304					
12	T 3638 300	T 3638 304					
14	T 3653 300	T 3653 304					
2							
3	T 3263 320						
4	T 3303 320						
5	T 3363 320						
5S ²⁾	T 3359 320						
6	T 3403 320						
7	T 3478 320						
7 ²⁾	T 3487 320						
8	T 3507 320						
12							
14							
2							
3	T 3263 330						
4	T 3303 330						
5	T 3363 330						
5S ²⁾	T 3359 330						
6	T 3403 330						
7	T 3478 330						
7 ²⁾	T 3487 330						
8	T 3507 330						
12							
14							

Assembly instruction³⁾

Panel cutout

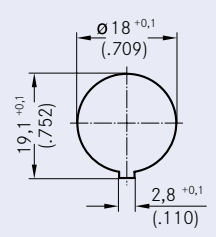
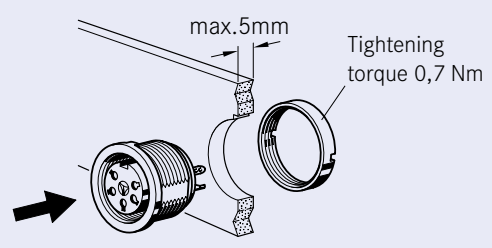

C 091 A Female receptacle | rear mounting

No. of cont.	Part Number solder termination		Part Number crimp termination	Drawing	Figure
	silver plating	gold plating ¹⁾			

Ring Nut (Hex nut on request)

(Please order crimp contacts separately, see page 56)



2	T 3203 100	T 3203 118	T 3203 150	<p>*Measure 12- and 14-pol.=10±0,3 termination: solder or crimp</p>			
3	T 3263 100	T 3263 118	T 3263 150				
4	T 3303 100	T 3303 118	T 3303 150				
5	T 3363 100	T 3363 118	T 3363 150				
5S ²⁾	T 3359 100	T 3359 118	T 3359 150				
6	T 3403 100	T 3403 118	T 3403 150				
7	T 3478 100	T 3478 118	T 3478 150				
7 ²⁾	T 3487 100	T 3487 118	T 3487 150				
8	T 3507 100	T 3507 118	T 3507 150				
12	T 3638 100	T 3638 118	T 3638 150				
14	T 3653 100	T 3653 118	T 3653 150				
2	T 3203 400	T 3203 404				<p>pin length 10.5 mm from flange termination: straight dip solder</p>	
3	T 3263 400	T 3263 404					
4	T 3303 400	T 3303 404					
5	T 3363 400	T 3363 404					
5S ²⁾	T 3359 400	T 3359 404					
6	T 3403 400	T 3403 404					
7	T 3478 400	T 3478 404					
7 ²⁾	T 3487 400	T 3487 404					
8	T 3507 400	T 3507 404					
12	T 3638 400	T 3638 404					
14	T 3653 400	T 3653 404					
2				<p>pin length 14.5 mm from flange termination: straight dip solder</p>			
3	T 3263 420	T 3263 424					
4	T 3303 420	T 3303 424					
5	T 3363 420	T 3363 424					
5S ²⁾	T 3359 420	T 3359 424					
6	T 3403 420	T 3403 424					
7	T 3478 420	T 3478 424					
7 ²⁾	T 3487 420	T 3487 424					
8	T 3507 420	T 3507 424					
12	T 3638 420	T 3638 424					
14	T 3653 420	T 3653 424					
2						<p>pin length 19.5 mm from flange termination: straight dip solder</p>	
3	T 3263 430	T 3263 434					
4	T 3303 430	T 3303 434					
5	T 3363 430	T 3363 434					
5S ²⁾	T 3359 430	T 3359 434					
6	T 3403 430	T 3403 434					
7	T 3478 430	T 3478 434					
7 ²⁾	T 3487 430	T 3487 434					
8	T 3507 430	T 3507 434					
12	T 3638 430	T 3638 434					
14	T 3653 430	T 3653 434					

Assembly instruction³⁾

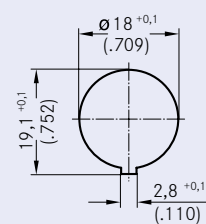
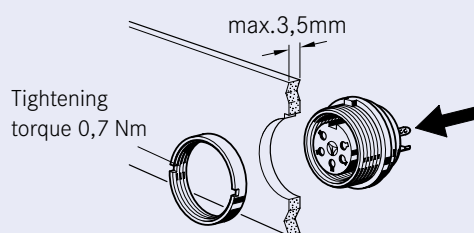

Panel cutout

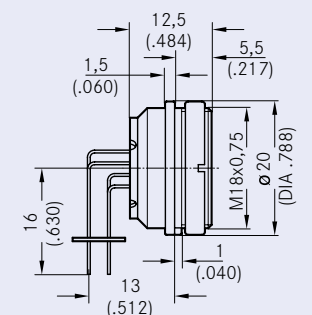

C 091 A Female receptacle | 90° | rear mounting

No. of cont.	Part Number solder termination		Part Number crimp termination	Drawing	Figure
	silver plating	gold plating ¹⁾			
Right-angled Ring Nut (Hex nut on request)			(Please order crimp contacts separately, see page 56)		
2					
3					
4					
5		T 3363 902			
5S ²⁾					
6		T 3403 902			
7					
7 ²⁾					
8					
12					
14					

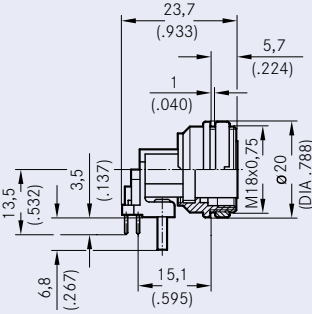
C 091 A Female receptacle | 90° | PCB mounting

No. of cont.	Part Number solder termination		Part Number crimp termination	Drawing	Figure
	silver plating	gold plating ¹⁾			
Right-angled Ring Nut (Hex nut on request)			(Please order crimp contacts separately, see page 56)		
2	T 3263 900				
3					
4					
5					
5S ²⁾	T 3359 900				
6					
7					
7 ²⁾	T 3487 900				
8	T 3507 900	T 3507 918			
12					
14					

Panel cutout ³⁾ | Female receptacle | 90° | rear mounting | PCB mounting

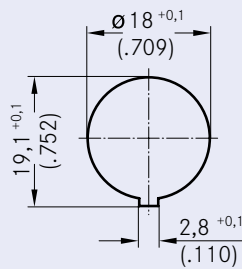

C 091 A Female receptacle | 90° | PCB flange mounting

No. of cont.	Part Number		Part Number crimp termination	Drawing	Figure
	silver plating	gold plating ¹⁾			

Right-angled

(Please order crimp contacts separately, see page 56)

2
3
4
5
5S²⁾
6
7
7²⁾
8
12
14

T 3363 218
T 3403 218

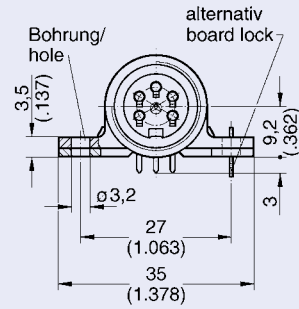

Panel cutout³⁾ | Female receptacle | 90° | PCB flange mounting

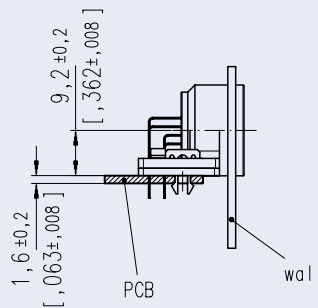
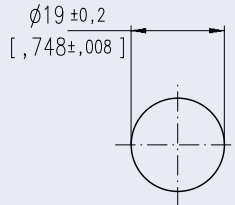

C 091 A Female receptacle | PCB-LAYOUT

PCB-LAYOUT (components side of circuit board)

Female receptacle | front mounting | rear mounting

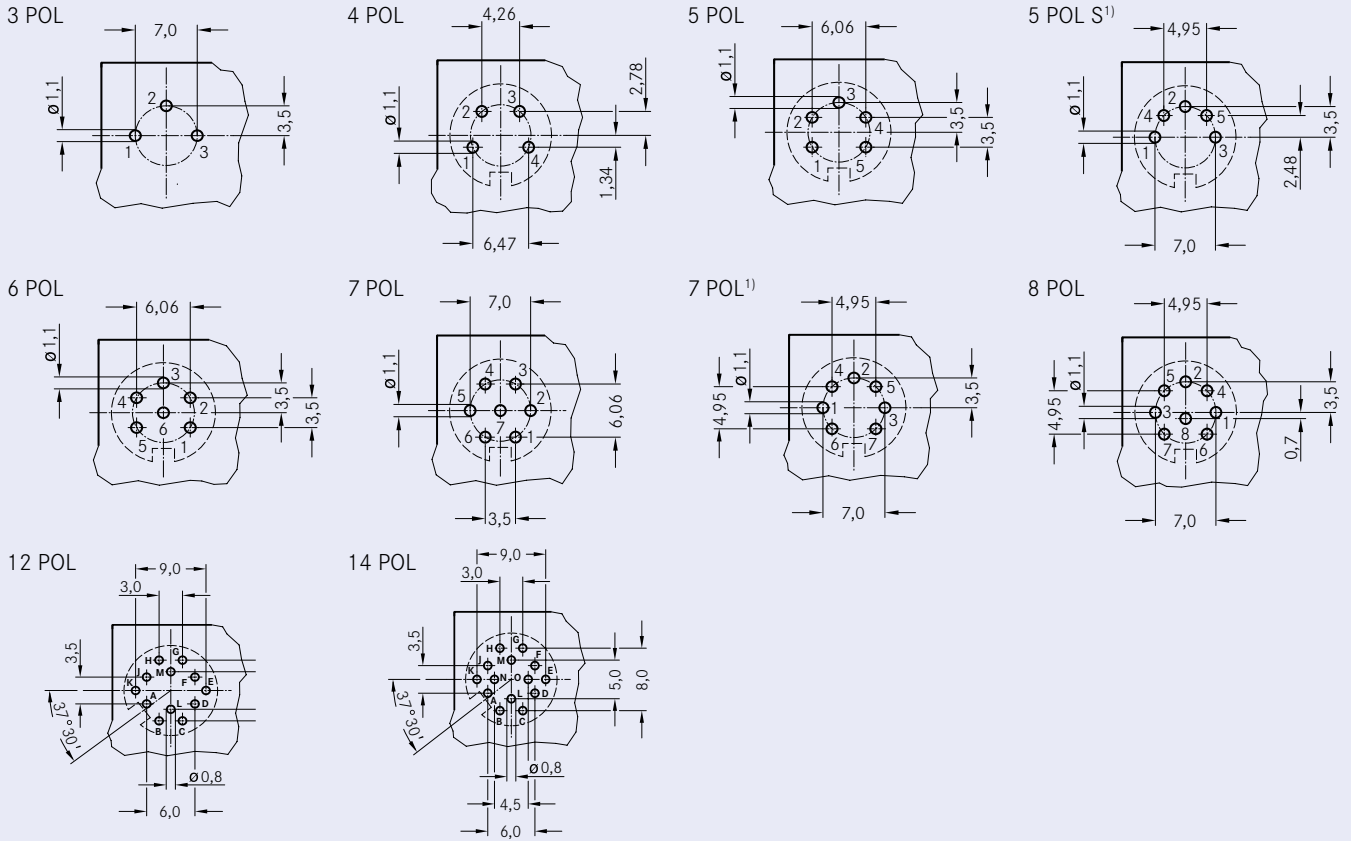

Female receptacle | 90° | rear mounting

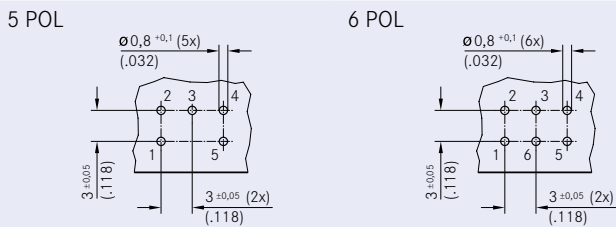

Female receptacle | 90° | PCB mounting

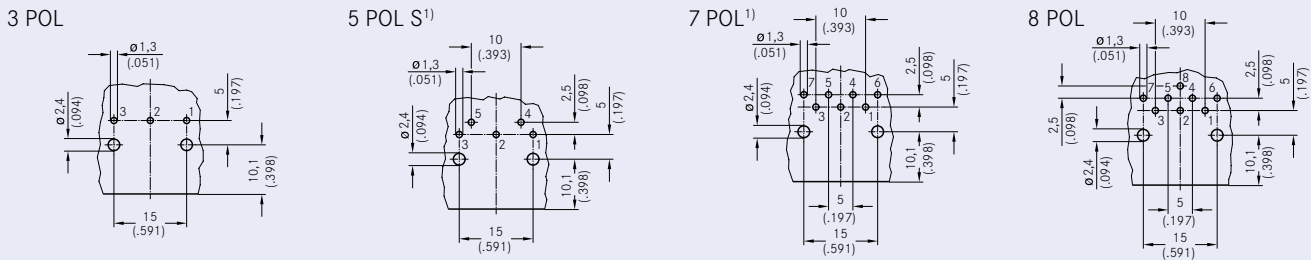

Female receptacle | 90° | PCB flange mounting

