

△數	訂正事項	檢圖	年月日	△數	訂正事項	檢圖	年月日
COUNT	DESCRIPTION OF REVISIONS	CHKD	DATE	COUNT	DESCRIPTION OF REVISIONS	CHKD	DATE
1	RE-6-1150	KIY	18.07.04				
2	RE-6-1579	KIY	20.01.23				

RECOMMENDED LAND PATTERN (FREE)
 (PCB THICKNESS t=1.6mm)

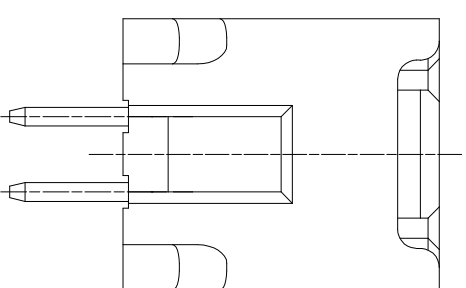

ENGAGEMENT FIGURE (2:1)

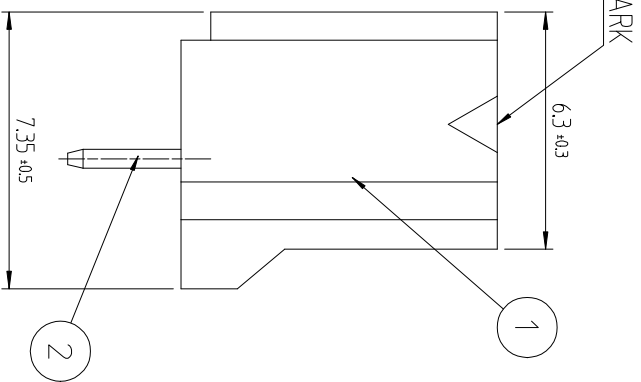
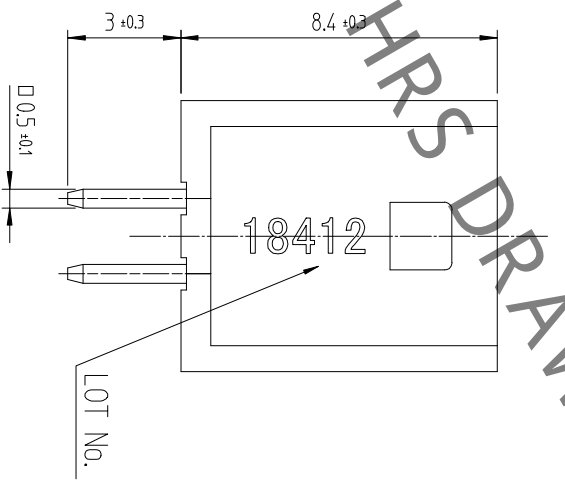
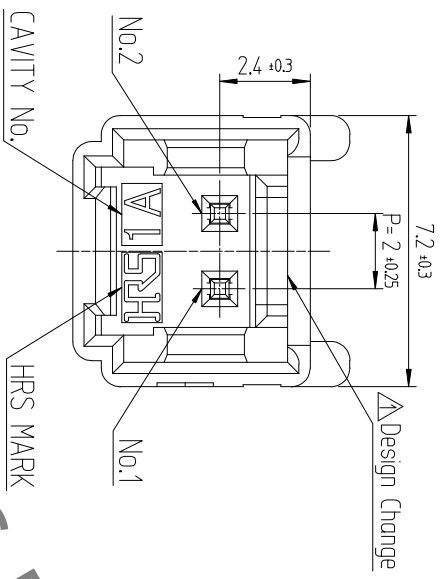
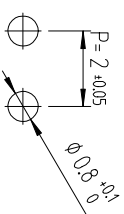
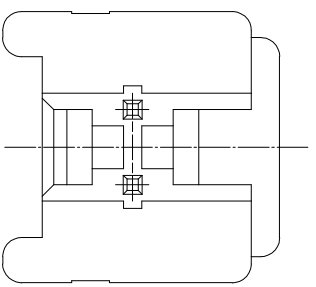
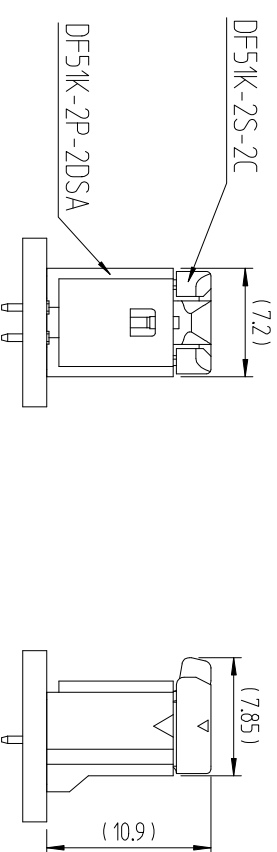

NOTE 1. 1PACK CONTAINS 100PCS.

2. () DIMENSIONS ARE ONLY REFERENCE.

3. UL-File No. E132750) AUTHORIZATION ARTICLE.

C-UL-File No. E132750) AUTHORIZATION ARTICLE.



1	△ PA66	UL94V-0, BLACK	2	BRASS	GOLD PLATING 0.1μm MIN, OVER NICKEL 0.5μm MIN		
NO.	MATERIAL	FINISH/REMARKS	NO.	MATERIAL	FINISH/REMARKS		
CODE NO. (OLD)				CODE NO.			
DRAWN		CHOI	DESIGNED		CHOI	CHECKED	
17.12.22		J.S	17.12.22		J.S	17.12.22	
LIM		SM	APPROVED		KANG	RELEASED	
17.12.22		T.S	20.02.12		ENG	DEPT	
DRAWING NO.		EDC3-632302		PART NO.		DF51K-2P-2DSA (805)	
SCALE		5:1		CODE NO.		CL 6652-0001-1-805	
UNITS		MM		1		1	