

10 9 8 7 6 5 4 3 2 1

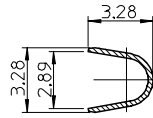

Section I-I

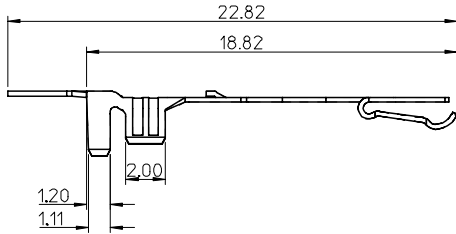
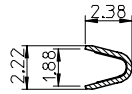

Section C-C

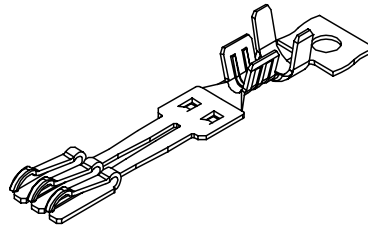
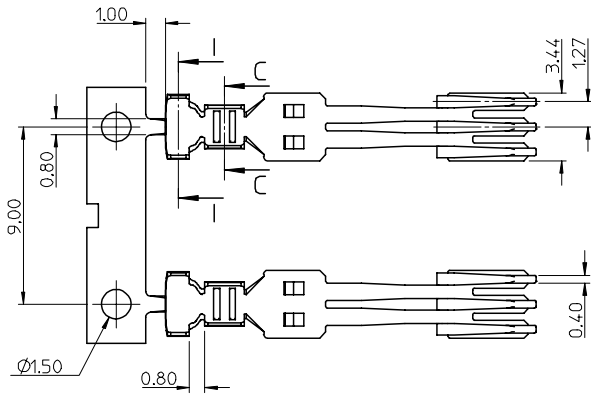

NOTES:

- MATERIAL :
PHOSPHOR BRONZE, THICKNESS = 0.25mm
- PLATING :
CONTACT AREA: (A) GOLD FLASH
(B) GOLD PLATED 0.76 MICRON.
(C) GOLD PLATED 0.38 MICRON.
CRIMPING AREA: TIN PLATED 1.875 MICRON MINIMUM.
UNDER PLATE: NICKELPLATED 1.25 MICRON MINIMUM.
- TO BE USED WITH 67582, 5 SETS TERMINAL PER HOUSING
- PRODUCT SPECIFICATION REFER TO PS-67490-002
- PACKAGE SPECIFICATION REFER TO PK-67581-001
- CRIMPING SPECIFICATION REFER TO CS-67581-001
- RECOMMEND WIRE SIZE: 18/20/22AWG
- PRODUCT COMPLIANT TO RoHS DIRECTIVE 2002/95/EC AND ELV DIRECTIVE 2000/53/EC.

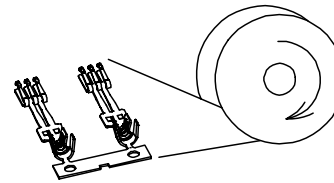

BEFORE CRIMPING
TYPE I

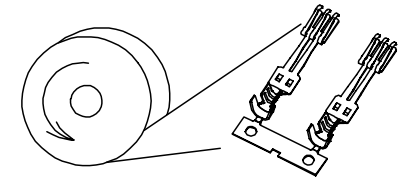

BEFORE CRIMPING
TYPE II

P/N	CONTACT AREA GOLD PLATING	TYPE
67581-0000	GOLD FLASH	TYPE I
67581-0001	0.76 MICRON GOLD PLATING	
67581-0002	0.38 MICRON GOLD PLATING	
67581-0010	GOLD FLASH	TYPE II
67581-0011	0.76 MICRON GOLD PLATING	
67581-0012	0.38 MICRON GOLD PLATING	

NEW RELEASE EC NO: SH2007-0312 DRWN: BCHENZ6 CHKD: JTIAN APPR: JNCHEN	QUALITY SYMBOLS ▽=0 ▽=0	GENERAL TOLERANCES (UNLESS SPECIFIED) mm INCH 4 PLACES ± --- ± --- 3 PLACES ± --- ± --- 2 PLACES ± 0.25 ± .010 1 PLACE ± 0.25 ± .010 ANGULAR ± 3 °	DIMENSION STYLE MM ONLY DRAWN BY DATE GRATE MA 2003/08/15 CHECKED BY DATE YA JUN 2003/08/15 APPROVED BY DATE SAM 2003/08/15	SCALE 4:1 DESIGN UNITS METRIC THIRD ANGLE PROJECTION	TITLE TERMINAL FOR SATA POWER CABLE RECEPTACLE
	MATERIAL NO. SEE TABLE	DOCUMENT NO. SD-67581-001	SHEET NO. 1 OF 1		
	DRAFT WHERE APPLICABLE MUST REMAIN WITHIN DIMENSIONS				
	THIS DRAWING CONTAINS INFORMATION THAT IS PROPRIETARY TO MOLEX INCORPORATED AND SHOULD NOT BE USED WITHOUT WRITTEN PERMISSION				

9 8 7 6 5 4 3 2 1