







# Outdoor

## Low profile direct mount Antenna

SKF450DM – 440-470 MHz



### Features & Applications:

-  Vehicle roof mount, directly on metal plane
-  440-470MHz
-  Cable length and connector type per request
-  Available in Black (P/N SKF450DM) or White (P/N SKF450DMW)
-  Heavy and light vehicles
-  IoT, navigation, tracking

### Electrical specifications @ 25° C

#### Frequency Band – 440-470 MHz

Antenna type <sup>1</sup>	Nominal Impedance	Polarization	Radiation pattern	Power withstanding	DC Ground
Dipole	50Ω	Vertical	Omni	100W	Yes

Frequency (MHz)	440-470
VSWR W/17FT (5.2M) Cable	2:1
Peak Gain (dBi)	2.2
Efficiency (%)	75
HPBW Vertical Plane (°)	62

### Mechanical Specifications

SKF450DM				
Size W/H/L	Color	Weight	Cable / Connector Type	Fixing System <sup>2</sup>
52.5 (2.07") x 63.6 (2.50") x 178.3 (7.02") mm	Black	375grms (0.83lbs)	RG-58 / SMA-Male	Direct Mount
Housing Material	Operating Temperature	Storage Temperature	Ingress Protection	RoHS-6 Compliant
UV Protected Plastic	-40°C to +85°C	-40°C to +85°C	IP67	Yes

#### Notes:

1. Measured on Ø24" (609.6mm) ground plane.
2. Requires Ø.875" (22.3mm) hole.

Test Setup / Charts

SKF450DM



antenna sample measured on Ø24" (609.6mm) ground plane

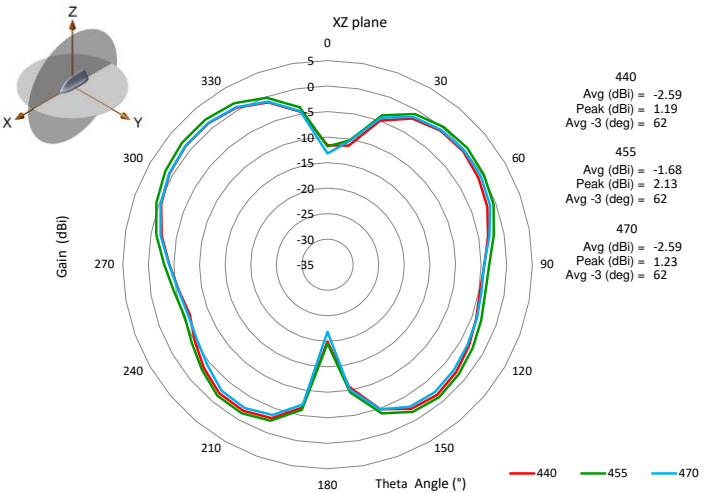
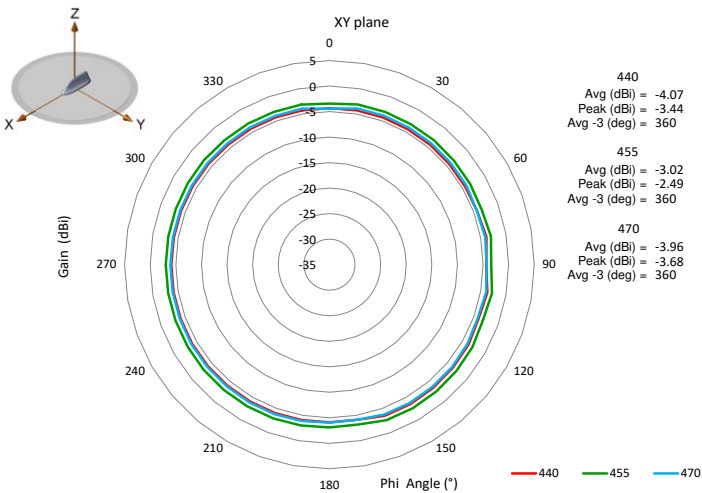
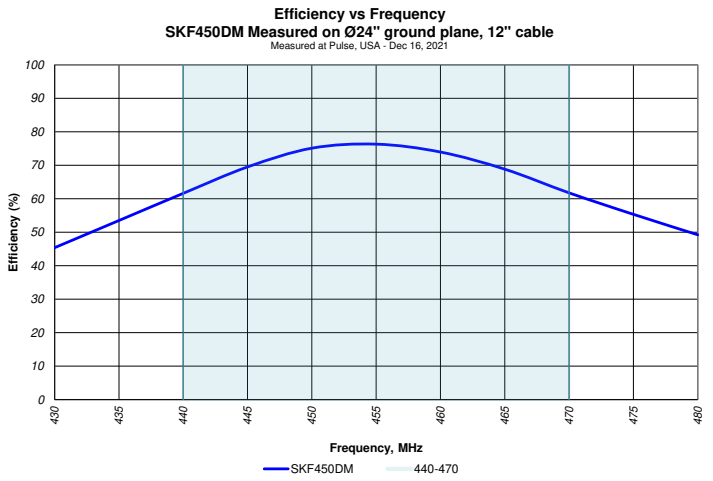
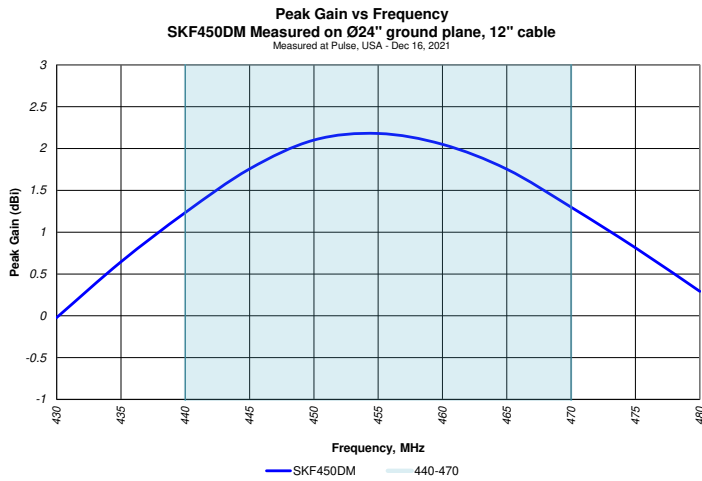
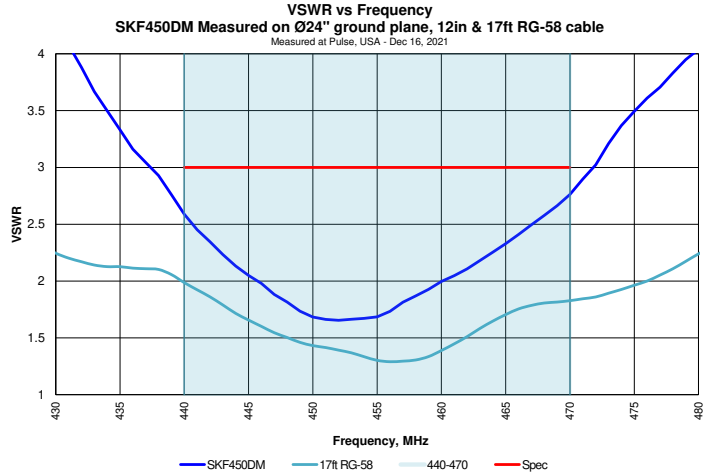

Mechanical Drawing

SKF450DM

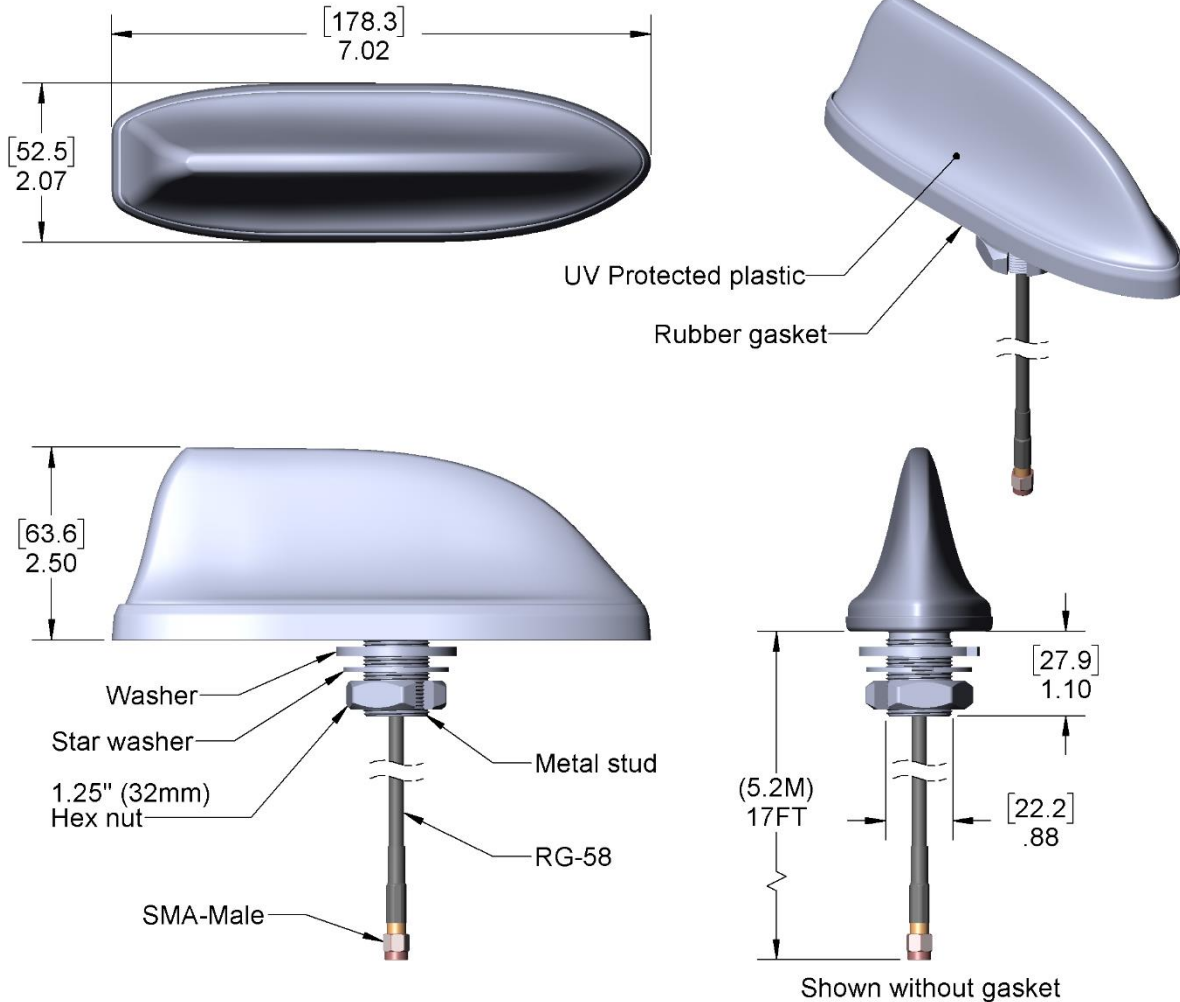

**Dimensions:** Inches (mm)  
 Unless otherwise specified, all tolerances are ±.010 (0.25mm)

Packaging

SKF450DM

**Packaging info:**

- 1 antenna packed in a plastic bag.
- 1 label on each plastic bag with part number, description, date code.

**Notes:**

- Please contact sales for availability, lead time, and/or any special requests. Samples available upon request.

**For More Information:**

Americas - [antennas.us@pulseelectronics.com](mailto:antennas.us@pulseelectronics.com) | Europe – [antennas.eu@pulseelectronics.com](mailto:antennas.eu@pulseelectronics.com) | Asia – [antennas.as@pulseelectronics.com](mailto:antennas.as@pulseelectronics.com) | Questions? +1-800-ANTENNA  
 Performance warranty of products offered on this data sheet is limited to the parameters specified. Data is subject to change without notice. Other brand and product names mentioned herein may be trademarks or registered trademarks of their respective owners. © Copyright , 2020. Pulse Electronics, Inc. All rights reserved.