

KENDALL HOWARD ®

The Answer is Yes! What's the Question?™

LAN STATION 19" X 14" SHELF, FOLKSTONE

Installation Instructions

Part Number 5200-3-420-00

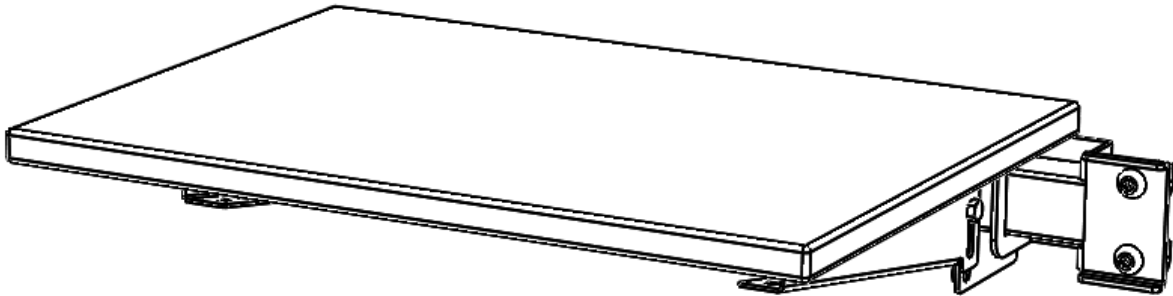

For Your Safety

Read and understand the entire manual before installing

TABLE OF CONTENTS

Support	2
Disclaimer	2
Dimensional Drawing	3
Specifications	3
Component Identification	4
Tools Needed	4
Installation Instructions.....	5
Installation Instructions Continued.....	6
Warranty.....	7

Support

Support is available through the following methods:

By Phone from 8:00 AM to 5:00 PM CST. 651.213.1333

By Email customerservice@kendallhoward.com

By Mail 10152 Liberty Lane, Chisago City, MN 55013

By Web www.kendallhoward.com

Disclaimer

DISCLAIMER: Kendall Howard LLC. endeavors to make this manual accurate and complete. However, Kendall Howard LLC makes no representations or warranties of any kind, expressed or implied, about whether the use of products contained herein would infringe any rights or the correctness, accuracy or reliability of the information contained herein or that said information covers all details, conditions, or variations. The information herein does not provide for every possible contingency in connection with the installation or use of the product(s). The information contained in this document is subject to change without notice or obligation. Kendall Howard LLC assumes no responsibility for the accuracy, completeness or reliability of the information contained in this document. Any reliance placed on the information is therefore strictly at your own risk.

Dimensional Drawing

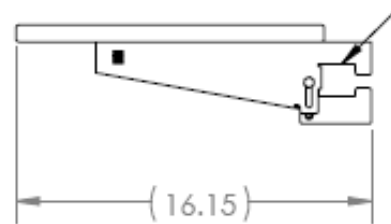
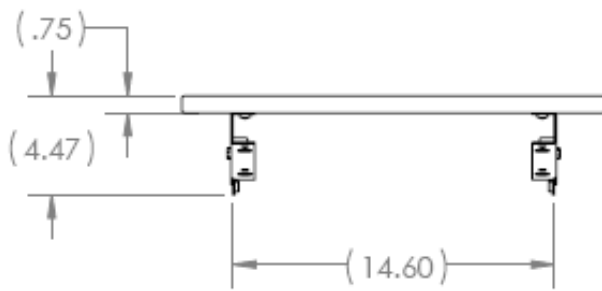
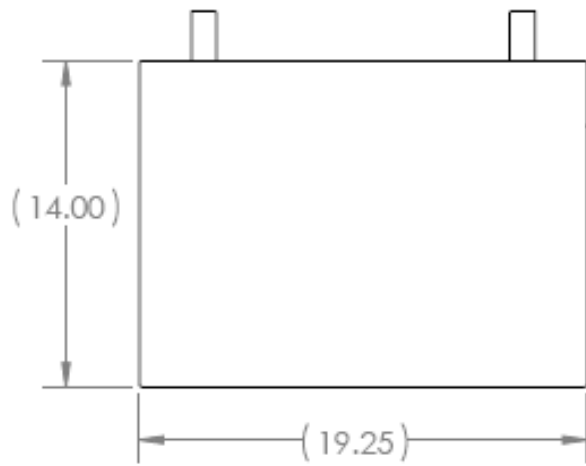

Specifications

Shelf dimensions	14" deep x 19.25" wide x .75" thick
Assembly weight	10 LBS.
Bracket material	14 gauge cold rolled steel, black powder coat
Shelf material	Laminate, Folkstone gray
Weight limit	40 LBS.

Component Identification

What's Included?

Left Shelf Bracket (1)
Part Number: A-1041

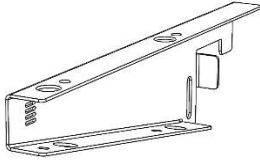

Left Shelf Clamp (1)
Part Number: A-1049

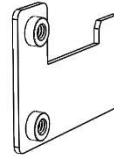

Right Shelf Bracket (1)
Part Number: A-1042

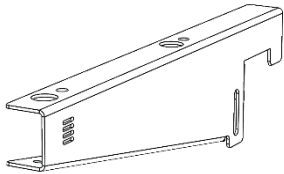

Right Shelf Clamp (1)
Part Number: A-2206

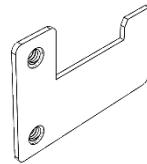

Wooden Shelf (1)
Part number: A-1043

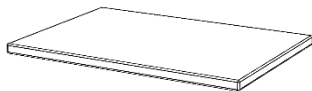

Shelf Lip (1)
Part Number: A-2206



¼-20 x .375 Hex Head Screw (2)
Part Number: H0241



¼-20 x .375 Pan Head Screw (4)
Part Number: HW-1261



#8 x .50 Pan Head Screw (4)
Part Number: HW-1224



Tools Needed:

Phillips screwdriver, standard box wrench set



Installation Instructions

Step 1:

Determine the desired position of the shelf. Shelf can be installed in a flat position or at a 10-degree downward angle. If a flat position is desired, the mounting brackets should be installed flat with the shelf as shown in figure 1. If a 10-degree downward angle is desired, flip the brackets over so the shelf brackets slope down as shown in figure 2.

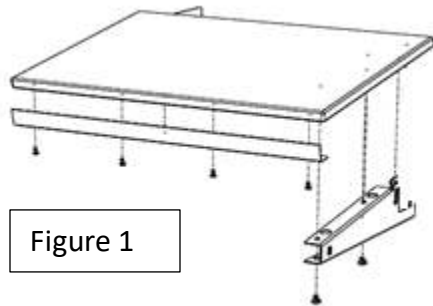

Figure 1



Figure 2

Step 2:

Locate the provided $\frac{1}{4}$ -20 x .375 pan head screws. Place the shelf upside down on a flat surface. With a Phillips head screwdriver, thread the four pan head screws through the mounting brackets and into the wooden shelf.

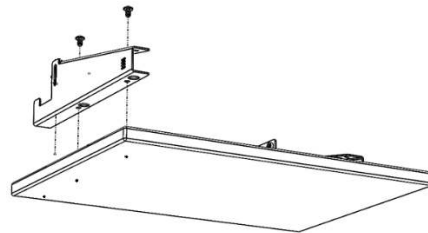

Step 3:

If the shelf is being installed in the sloped position or if an additional barrier is needed, locate the shelf retainer bracket and the four provided #8 x .50 pan head screws. Thread the screws through the bracket and into the wooden shelf.

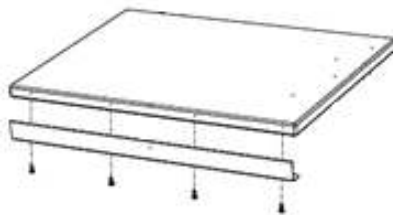

Step 4:

Locate the left and right shelf clamps and the two ¼-20 x .375 hex head screws. Loosely install the screw through the shelf clamps into the shelf brackets.

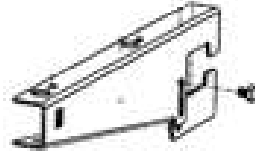

Note:

The shelf clamp will sit flat on the shelf bracket with the threaded insert facing inward.

Step 5:

Take the assembled shelf and place the mounting brackets on to an accessory bar. Lift up on the shelf clamp and fully tighten hardware.

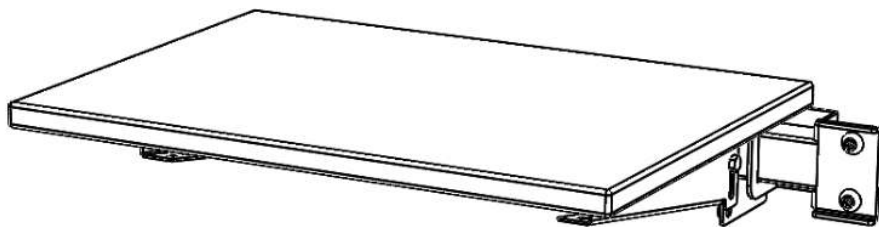

Warranty

GENERAL: Kendall Howard offers all users of our products the following Limited Warranty against defects in material and workmanship. Please read your Warranty carefully. This Warranty sets forth our responsibilities in the unlikely event of defect and tells you how to obtain resolution.

TERMS OF WARRANTY: Kendall Howard products are warranted to be free of defects in material and workmanship. If any part or portion of the Kendall Howard product fails to conform to the Warranty, Kendall Howard, at its option, will furnish new or factory remanufactured products for repair or replacement of that part.

WARRANTY EXTENDS TO FIRST PURCHASER FOR USE, NON-TRANSFERABLE: This Warranty is extended to the first person, firm, association, or corporation for whom the Kendall Howard product specified herein is originally sold for use in the United States (the "User"). This Warranty is not transferable or assignable without the prior written permission of Kendall Howard.

ASSIGNMENT OF WARRANTIES: Kendall Howard assigns to User any warranties which are made by manufacturers and suppliers of components of the Kendall Howard product and which are assignable, but Kendall Howard makes NO REPRESENTATIONS as to the effectiveness or extent of such warranties, assumes NO RESPONSIBILITY for any matters which may be warranted by such manufacturers or suppliers and extends no coverage under this Warranty to such components.

DRAWINGS, DESCRIPTIONS: Kendall Howard warrants for the period and on the terms of the Warranty set forth herein that the Kendall Howard product will conform to the descriptions contained in Kendall Howard final invoices, orders, proposals (as modified) and other Kendall Howard descriptive documents ("Descriptions"). Kendall Howard does not control the use of any Kendall Howard product. Accordingly, it is understood that the Descriptions are NOT WARRANTIES OF PERFORMANCE and NOT WARRANTIES OF FITNESS FOR A PARTICULAR PURPOSE.

WARRANTY CLAIMS PROCEDURE: Within a reasonable time, but in no case to exceed thirty (30) days, after User's discovery of a defect, User shall contact Kendall Howard. Subject to the limitations specified herein, a Kendall Howard customer service representative will repair or replace the non-conforming Kendall Howard product warranted hereunder, without charge for materials. User will not be charged for labor if performed within thirty (30) days of product purchase. In all other instances, User will be charged for labor performed at Kendall Howard's then current rates. Kendall Howard shall assume shipping costs for replacement products and return of the defective product to Kendall Howard. Warranty coverage will be extended only after Kendall Howard inspection determines there is a defect as claimed and shows no signs of treatment or use which would void the coverage of this Warranty.

WARRANTY PERFORMANCE OF COMPONENT MANUFACTURERS: It is Kendall Howard's practice, consistent with its desire to remedy Warranty defects in the most prompt and effective manner possible, to cooperate with and utilize the services of component manufacturers and their authorized representatives in the performance of work to correct defects in Kendall Howard components. Accordingly, Kendall Howard may utilize third parties in the performance of Warranty work, including repair or replacement hereunder, where, in Kendall Howard's opinion, such work can be performed in less time, and with less expense.

ITEMS NOT COVERED BY WARRANTY: THIS WARRANTY DOES NOT COVER DAMAGE OR DEFECT CAUSED BY misuse, improper application, wrong or inadequate electrical current or connection, negligence, inappropriate on site operating conditions, repair by non-Kendall Howard designated personnel, accident in transit, tampering, alterations, a change in location or operating use, exposure to the elements, Acts of God, theft or installation contrary to Kendall Howard's recommendations or specifications, or in any event if the Kendall Howard serial number has been altered, defaced, or removed. THIS WARRANTY DOES NOT COVER installation costs, external circuit breaker resetting or maintenance or service items and further, except as may be specifically provided for herein, does NOT include labor or shipping costs arising from the repair or replacement of the Kendall Howard product, or any part thereof, or charges to remove same from any premises of User. THIS WARRANTY IS VOID if User alters the product in any way.

LIMITATIONS: THIS WARRANTY IS IN LIEU OF AND EXCLUDES ALL OTHER WARRANTIES, EXPRESS OR IMPLIED, INCLUDING MERCHANTABILITY AND FITNESS FOR A PARTICULAR PURPOSE. USER'S SOLE AND EXCLUSIVE REMEDY IS REPAIR OR REPLACEMENT OF THE KENDALL HOWARD PRODUCT AS SET FORTH HEREIN. IF USER'S REMEDY IS DEEMED TO FAIL OF ITS ESSENTIAL PURPOSE BY A COURT OF COMPETENT JURISDICTION, KENDALL HOWARD'S RESPONSIBILITY FOR PROPERTY LOSS OR DAMAGE SHALL NOT EXCEED ONE TIMES THE NET PRODUCT PURCHASE PRICE. IN NO EVENT SHALL KENDALL HOWARD ASSUME ANY LIABILITY FOR INDIRECT, SPECIAL, INCIDENTAL, EXEMPLARY OR CONSEQUENTIAL DAMAGES OF ANY KIND WHATSOEVER, INCLUDING WITHOUT LIMITATION LOST PROFITS, BUSINESS INTERRUPTION OR LOSS OF DATA, WHETHER ANY CLAIM IS BASED UPON THEORIES OR CONTRACT, NEGLIGENCE, STRICT LIABILITY, TORT, OR OTHERWISE.

MISCELLANEOUS: NO SALESPERSON, EMPLOYEE OR AGENT OF KENDALL HOWARD IS AUTHORIZED TO ADD TO OR VARY THE TERMS OF THIS WARRANTY. Warranty terms may be modified, if at all, only in writing signed by a Kendall Howard officer. This Warranty is effective as of the date of Kendall Howard receipt of full payment and supersedes all previous warranties Kendall Howard reserves the right to supplement or change the terms of this Warranty in any subsequent warranty offering to User or others. If any provision of this Warranty should be or becomes invalid and/or unenforceable during the warranty period, the remaining terms and provisions shall continue in full force and effect. User must complete the attached User Information Card and forward it to Kendall Howard within thirty (30) days of receipt of the Kendall Howard product. This Warranty is given in and performance hereunder is to be construed under the laws of the State of Nebraska. This Warranty represents the entire agreement between Kendall Howard and User with respect to the subject matter herein and supersedes all prior or contemporaneous oral or written communications, representations, understandings, or agreements relating to this subject.