



Micro Commercial Components



Micro Commercial Components
20736 Marilla Chatsworth
CA 91311
Phone: (818) 701-4933
Fax: (818) 701-4939

SF61
THRU
SF66

6.0 Amp Super Fast
Rectifier
50 to 400 Volts

Features

- Lead Free Finish/RoHS Compliant(Note 1) ("P" Suffix designates RoHS Compliant. See ordering information)
Epoxy meets UL 94 V-0 flammability rating
Moisture Sensitivity Level 1
Halogen free available upon request by adding suffix "-HF"
High current capability, High reliability
Low forward voltage drop
High surge current capability

Maximum Ratings

Operating Temperature: -65 to +125
Storage Temperature: -65 to +150
For capacitive load, derate current by 20%

Table with 4 columns: MCC Part Number, Maximum Recurrent Peak Reverse Voltage, Maximum RMS Voltage, Maximum DC Blocking Voltage. Rows include SF61 through SF66.

Electrical Characteristics @ 25 C Unless Otherwise Specified

Table with 4 columns: Parameter, Symbol, Value, Conditions. Rows include Average Forward Current, Peak Forward Surge Current, Maximum Instantaneous Forward Voltage, Maximum DC Reverse Current, Typical Junction Capacitance, and Maximum Reverse Recovery Time.

Notes: 1. High Temperature Solder Exemption Applied, see EU Directive Annex Notes 7.
2. Pulse Test: Pulse width 300 usec, Duty cycle 1%.

DO-201AD

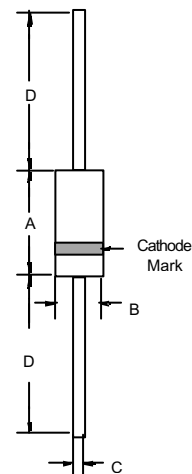
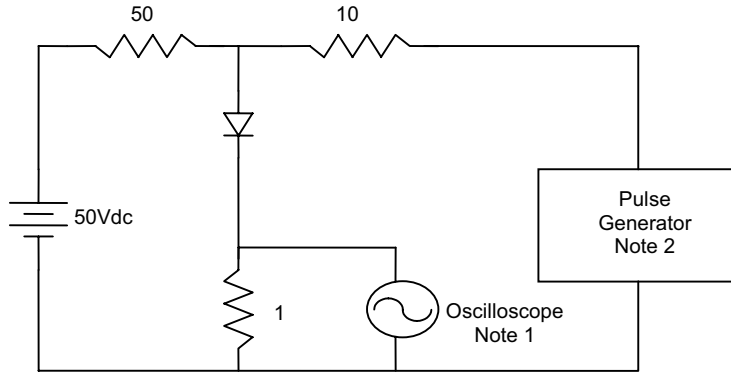

Table titled DIMENSIONS with columns for DIM, INCHES (MIN, MAX), MM (MIN, MAX), and NOTE. Rows A, B, C, D.

SF61 thru SF66

Figure1
Reverse Recovery Time Characteristic And Test Circuit Diagram



- Notes:
1. Rise Time = 7ns max.
Input impedance = 1 megohm, 22pF
 2. Rise Time = 10ns max.
Source impedance = 50 ohms
 3. Resistors are non-inductive

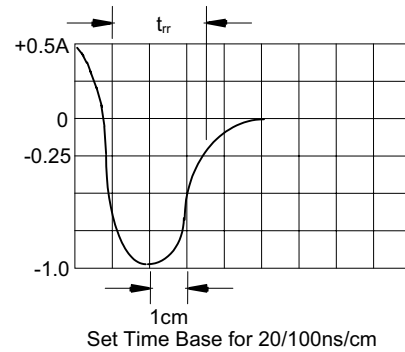

Figure 2
Forward Derating Curve

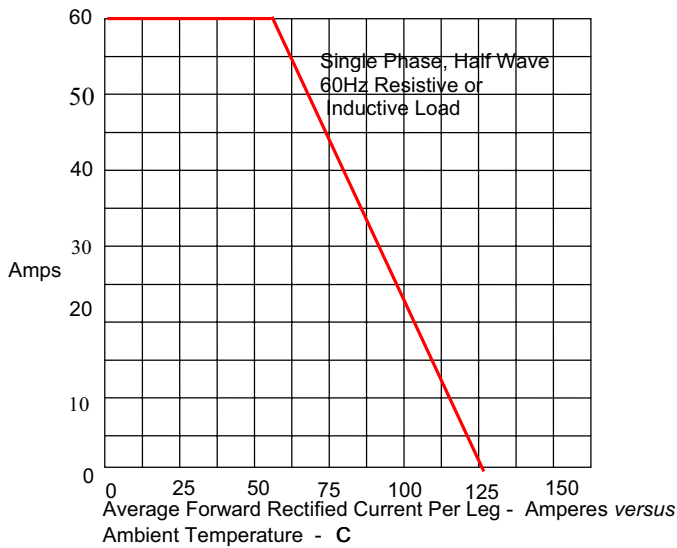
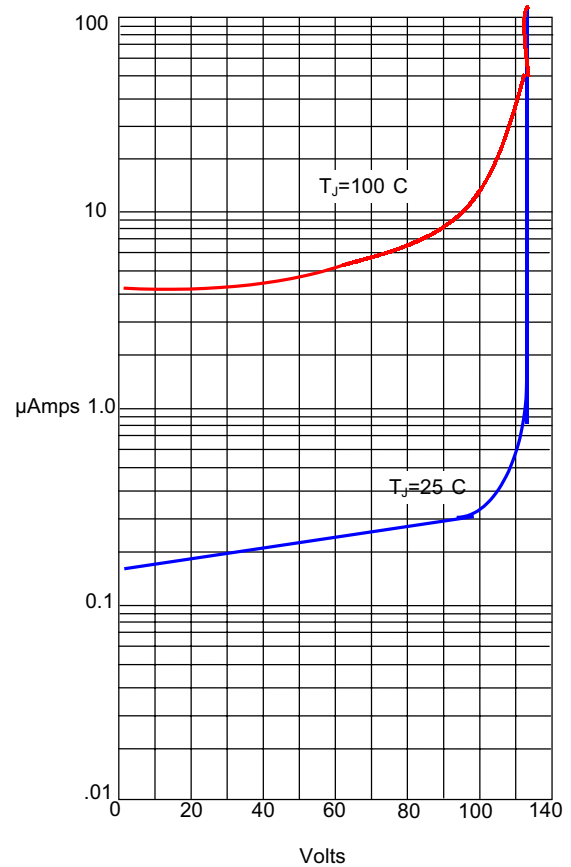

Figure 3
Typical Reverse Characteristics



Instantaneous Reverse Leakage Current -MicroAmperes versus Percent Of Rated Peak Reverse Voltage - Volts

SF61 thru SF66

Figure 4
Typical Forward Characteristics

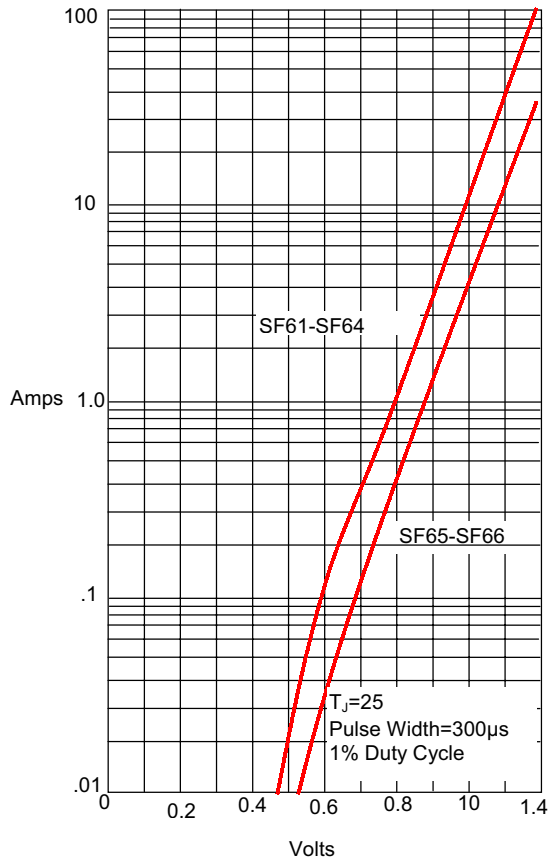

Instantaneous Forward Current - Amperes versus Forward Voltage - Volts

Figure 5
Peak Forward Surge Current

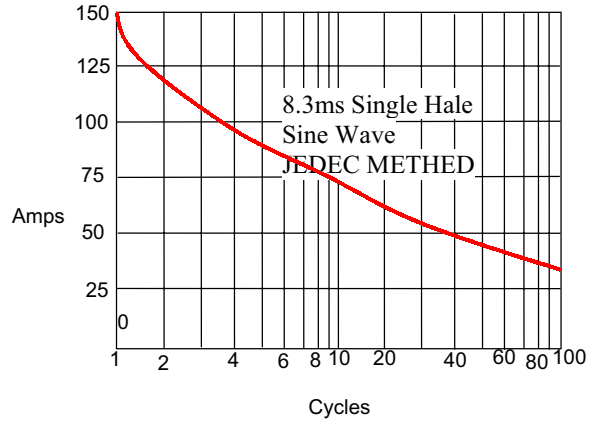

Peak Forward Surge Current - Amperes versus Number Of Cycles At 60Hz - Cycles

Figure 6
Typical Junction Capacitance

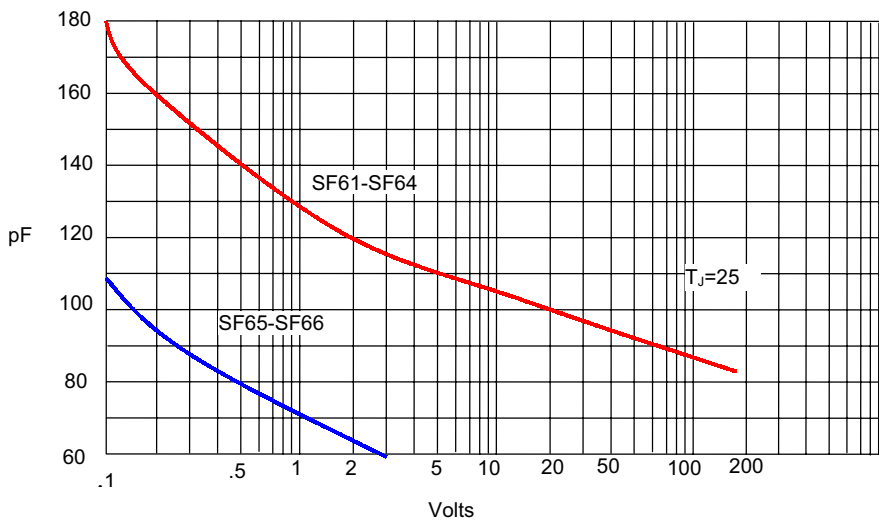

Junction Capacitance - pF Reverse Voltage - Volts



Micro Commercial Components

Ordering Information :

Device	Packing
Part Number-TP	Tape&Reel: 1.2Kpcs/Reel
Part Number-AP	Ammo Packing: 1.2Kpcs/Ammo Box
Part Number-BP	Bulk: 12Kpcs/Carton

Note : Adding "-HF" suffix for halogen free, eg. Part Number-TP-HF

IMPORTANT NOTICE

Micro Commercial Components Corp. reserves the right to make changes without further notice to any product herein to make corrections, modifications , enhancements , improvements , or other changes . **Micro Commercial Components Corp .** does not assume any liability arising out of the application or use of any product described herein; neither does it convey any license under its patent rights ,nor the rights of others . The user of products in such applications shall assume all risks of such use and will agree to hold **Micro Commercial Components Corp .** and all the companies whose products are represented on our website, harmless against all damages.

LIFE SUPPORT

MCC's products are not authorized for use as critical components in life support devices or systems without the express written approval of Micro Commercial Components Corporation.

CUSTOMER AWARENESS

Counterfeiting of semiconductor parts is a growing problem in the industry. Micro Commercial Components (MCC) is taking strong measures to protect ourselves and our customers from the proliferation of counterfeit parts. MCC strongly encourages customers to purchase MCC parts either directly from MCC or from Authorized MCC Distributors who are listed by country on our web page cited below. Products customers buy either from MCC directly or from Authorized MCC Distributors are genuine parts, have full traceability, meet MCC's quality standards for handling and storage. **MCC will not provide any warranty coverage or other assistance for parts bought from Unauthorized Sources.** MCC is committed to combat this global problem and encourage our customers to do their part in stopping this practice by buying direct or from authorized distributors.

www.mccsemi.com