



FEATURES:

- Constant Current LED Driver
- Low Output Current Ripple
- Active Power Factor Correction
- Short Circuit, Over Voltage, Over Temperature Protection
- No Flicker
- IP62 rated
- Low THD
- 5 Year Warranty



Models
Single output

Model	Max Output Power (W)	Output Voltage Range (V)	Output Current (mA)	Input Voltage (VAC/Hz)	Efficiency 230VAC (%)
AMEPR40N-4280Z	33.6	24-42	800	90-305/47-63	82
AMEPR40N-4285Z	35.7	24-42	850	90-305/47-63	83
AMEPR40N-4290Z	37.8	24-42	900	90-305/47-63	84
AMEPR40N-42100Z	42.0	24-42	1000	90-305/47-63	84

NOTE: All specifications in this datasheet are measured at an ambient temperature of 25°C, humidity <75%, nominal input voltage and at rated output load unless otherwise specified.

Input Specifications

Parameters	Conditions	Typical	Maximum	Units
Input Current	90 VAC, full load		0.63	Arms
Inrush current <2ms	230 VAC, cold start		60	A
Leakage current			0.75	mA
Input dissipation	115Vac, no load		1.9	W
	230Vac, no load		2.9	
	277Vac, no load		3.1	
Power Factor	115 VAC, full load		0.99	
	277 VAC, full load		0.95	
Input Fuse			250V/2A	
Start-up Time	115 VAC, full load		1.5	Sec.
	277 VAC, full load		1.0	Sec.
THD	115Vac, full load, 36Vout		15	%
	230Vac, full load, 36Vout		20	
	277Vac, full load, 36Vout		25	

Output Specifications

Parameters	Conditions	Typical	Maximum	Units
Current accuracy		±5		%
Line regulation	LL to HL	±1		%
Load regulation	Full Output Voltage Range	±1		%
Ripple & Noise*		150	420	mV p-p
Output Current Ripple*	Full load		50	mA
Current Overshoot	LL to HL, full load at cold start		10	%
Hold-up time (min.)			1.0	ms
Minimum Load Voltage	See Models Table Above			

* Tested with 0.1µF (C/C) or (M/C) and 10µF (E/C) parallel capacitors at the end.

Isolation Specifications

Parameters	Conditions	Typical	Rated	Units
Tested I/O voltage	I/P – O/P		3750	VAC
	I/P – FG		2000	VAC
	O/P – FG		500	VAC
Isolation Resistance	I/P – O/P, 500Vdc	>100MΩ		VAC
Isolation Capacitance		150		pF

General Specifications

Parameters	Conditions	Typical	Maximum	Units
Switching frequency		100		KHz
Over voltage protection	Limiting Voltage		49	VDC
Short circuit protection		Continuous, Hiccup Mode		
Input power while Short circuit	230VAC		3	W
Over Temperature Protection	Threshold – Shutdown Output	+103		°C
	Hysteresis – Auto Recovery	+85		°C
Operating temperature	Without derating	-30 to +50		°C
Maximum case temperature			95	°C
Warranty case temperature			60	°C
Storage temperature		-40 to +85		°C
Temperature coefficient			0.05	% / °C
Cooling	Free Air Convection			
Humidity			20 - 90	% RH
Atmospheric pressure			86-106	Kpa
Case material	Plastic			
IP Rating	IP62			
Weight		180		g
Dimensions (L X W+ X H)	6.61 x 1.85 x 0.98 inches		168.0 x 47.0 x 25.0 mm	
MTBF	450,000 hrs (MIL-HDBK-217F at +25°C)			

Safety Specifications

Parameters		
Standards	Electromagnetic Interference	EN55015 / FCC Part 15, Class B
	Harmonic Current Emissions	EN61000-3-2, Class B
	Voltage fluctuations and flicker	EN61000-3-3
	Electrostatic Discharge Immunity	EN61000-4-2, 8kV Air, 4kV Contact, Level 3, Criteria A
	RF, Electromagnetic Field Immunity	EN61000-4-3, Test-RS Level 3, Criteria A
	Electrical Fast Transient / Burst Immunity	EN61000-4-4, Burst EFT Level 3, Criteria A
	Surge Immunity	EN61000-4-5, Line to Neutral 2kV, Line/Neutral to PE 4kV
	RF, Conducted Disturbance Immunity	EN61000-4-6. Test-CS Level 3, Criteria A
	Power frequency Magnetic Field Immunity	EN61000-4-8, Test 3A/m, Criteria A
	Voltage dips, Short Interruptions Immunity	EN61000-4-11, Criteria B
	Electromagnetic Immunity Requirements Applies to Lighting Equipment	EN61547
	Designed in compliance with UL 8750, Type TL, class P, EN 61347-1, EN 61347-2-13, EN 60950-1	

Pin Definition

Recommended Wire gauge	Connection
20-24	AC L
20-24	AC N
14-26	LED+
14-26	LED-

Application Block diagram

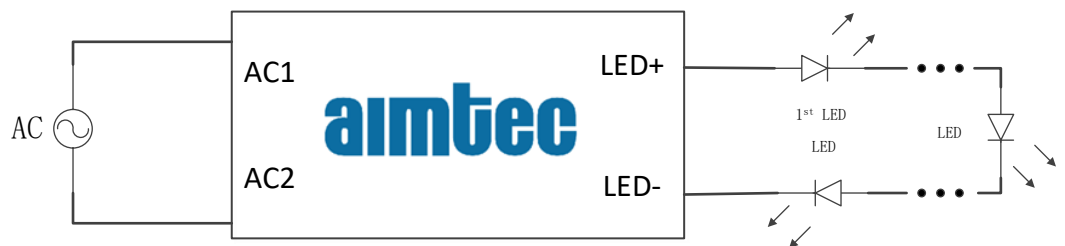

Dimensions

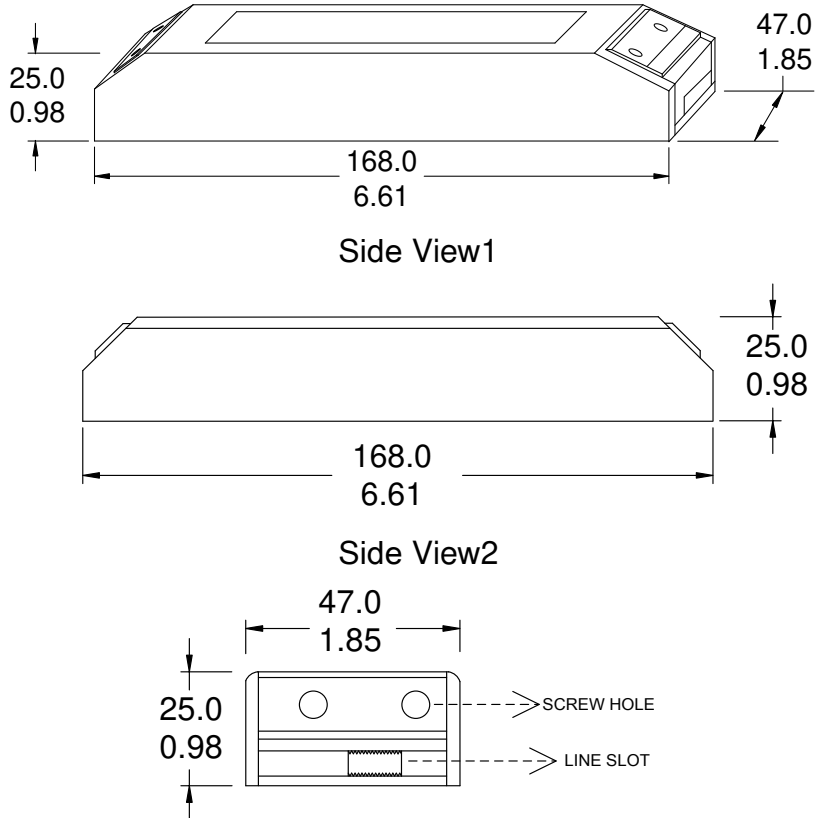

Efficiency Vs. Input Voltage & Output Current (Constant current load)

AMEPR40N-4280Z

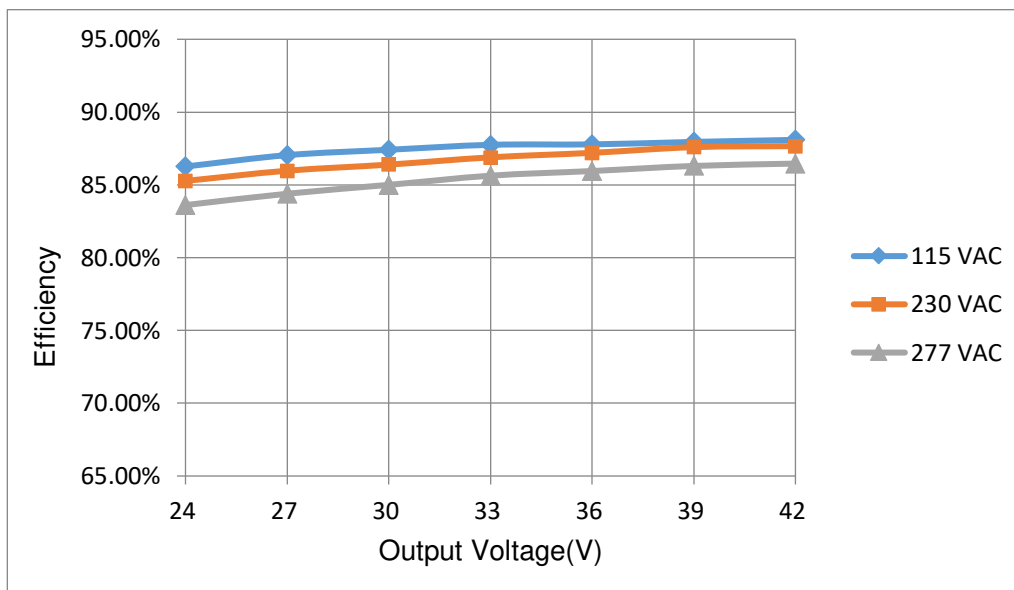

AMEPR40N-4285Z

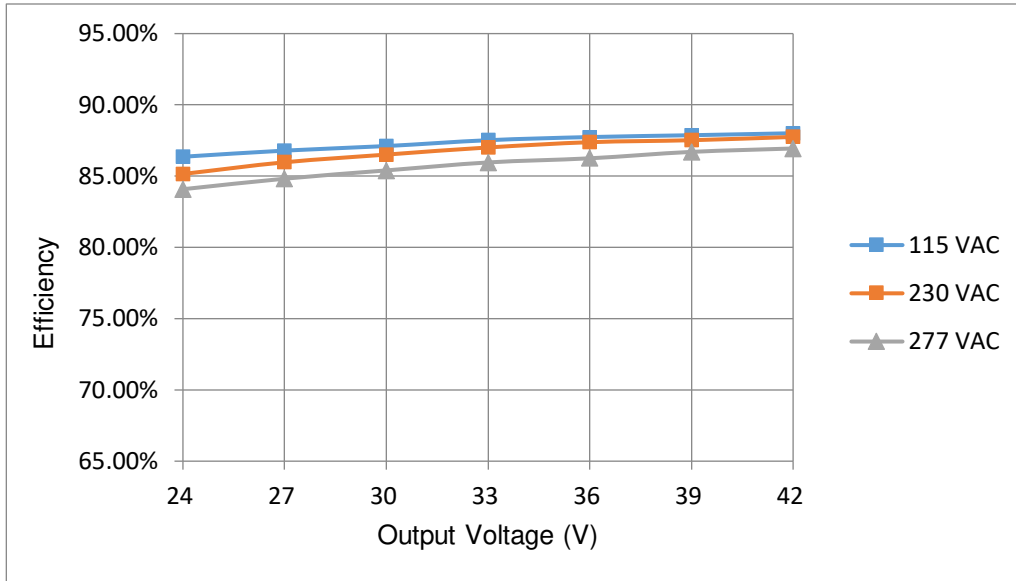

AMEPR40N-4290Z

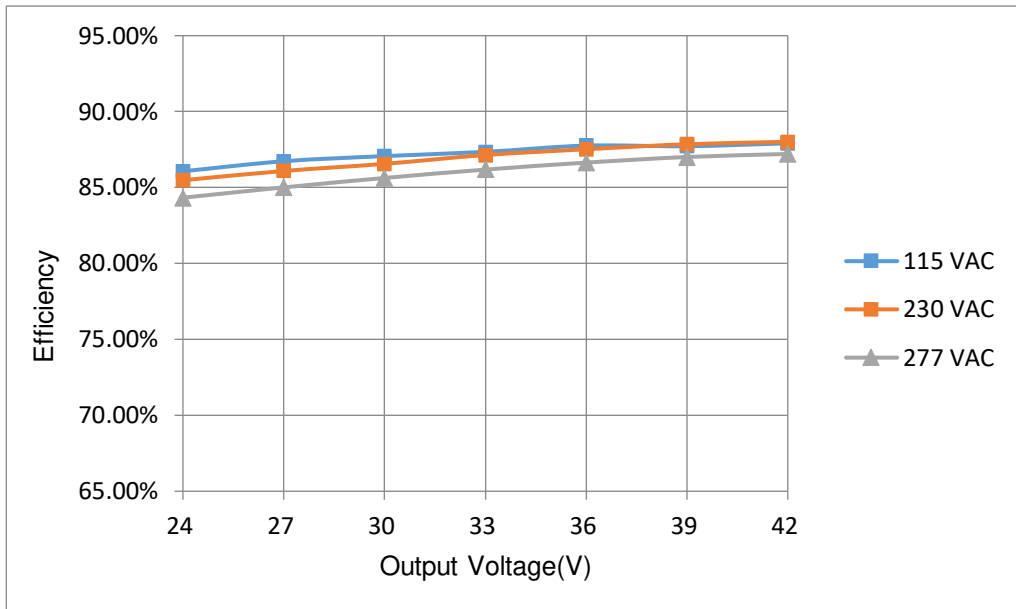

AMEPR40N-42100Z

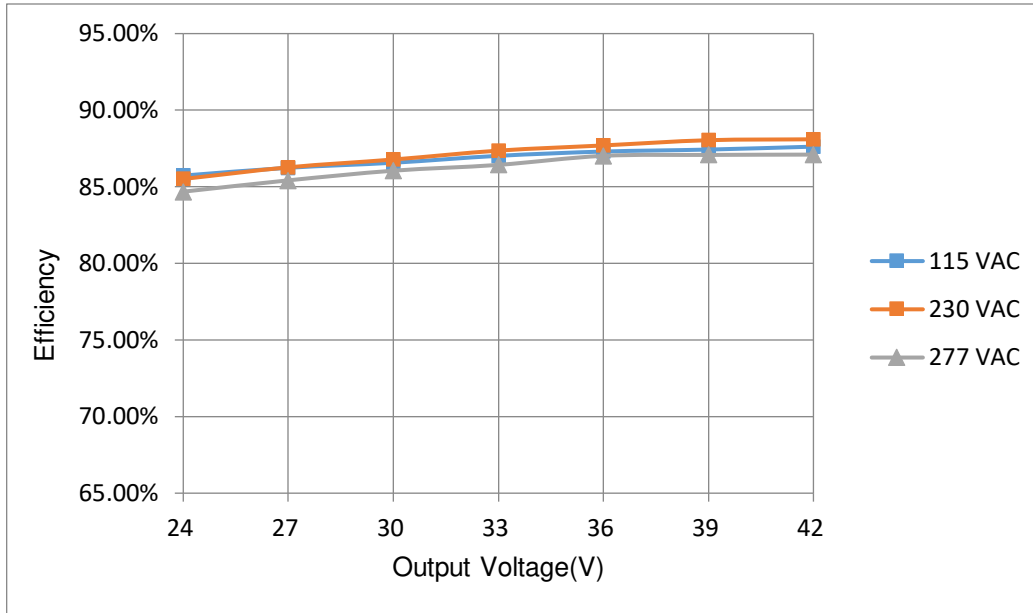

PFC Value vs. Output Load Current (constant current mode)

AMEPR40N-4280Z

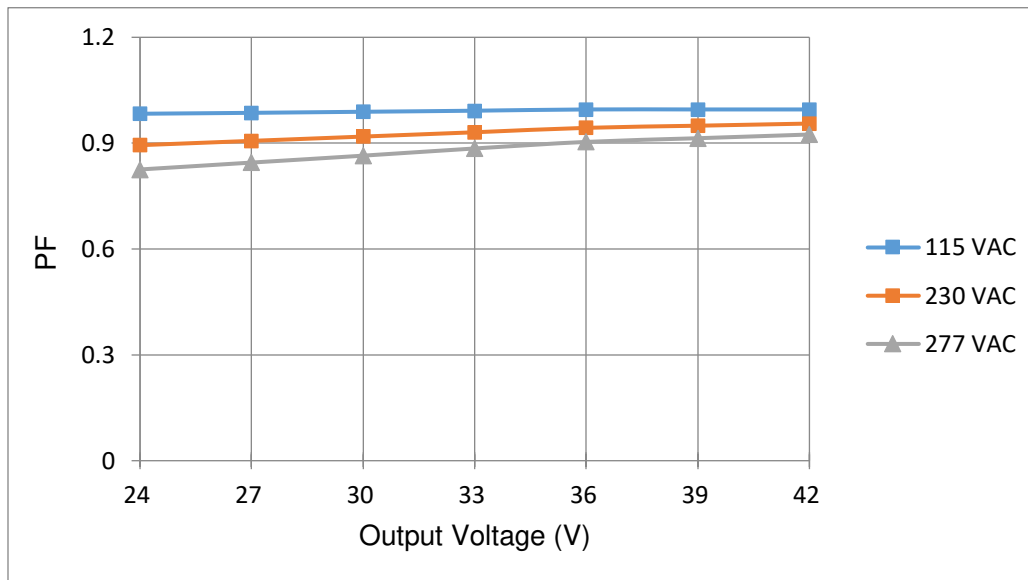

AMEPR40N-4285Z

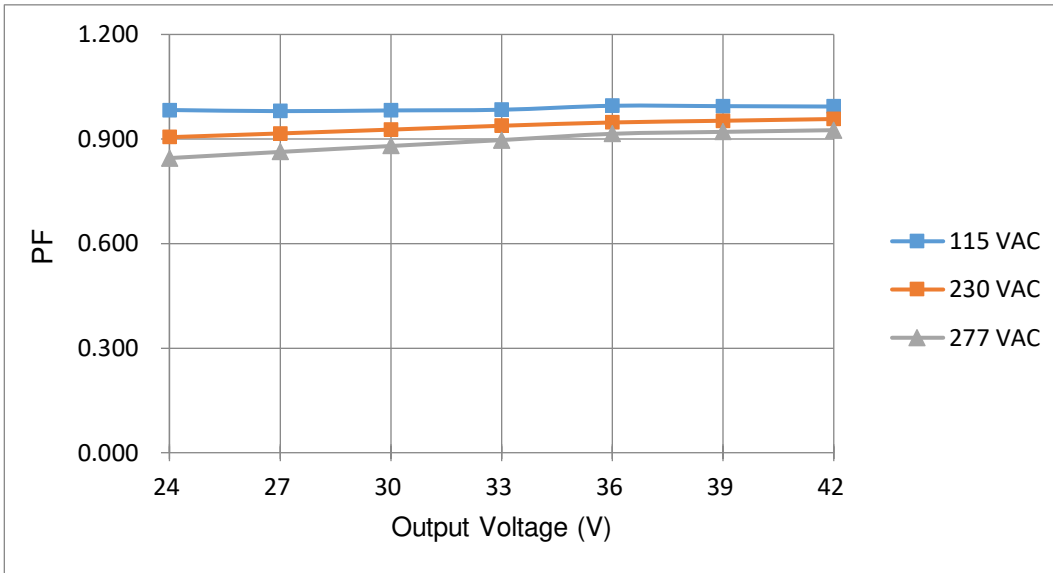

AMEPR40N-4290Z

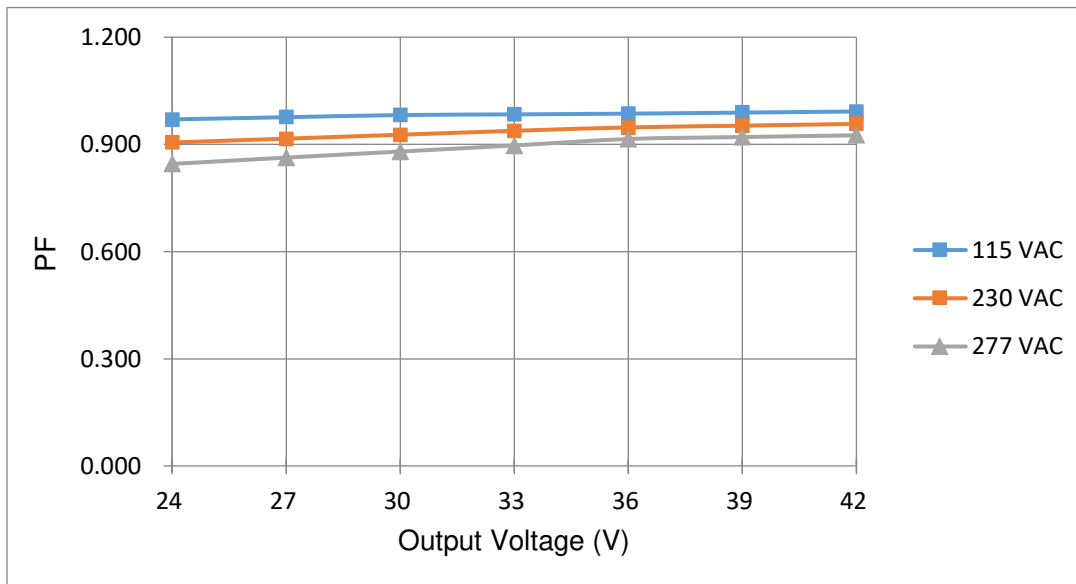

AMEPR40N-42100Z

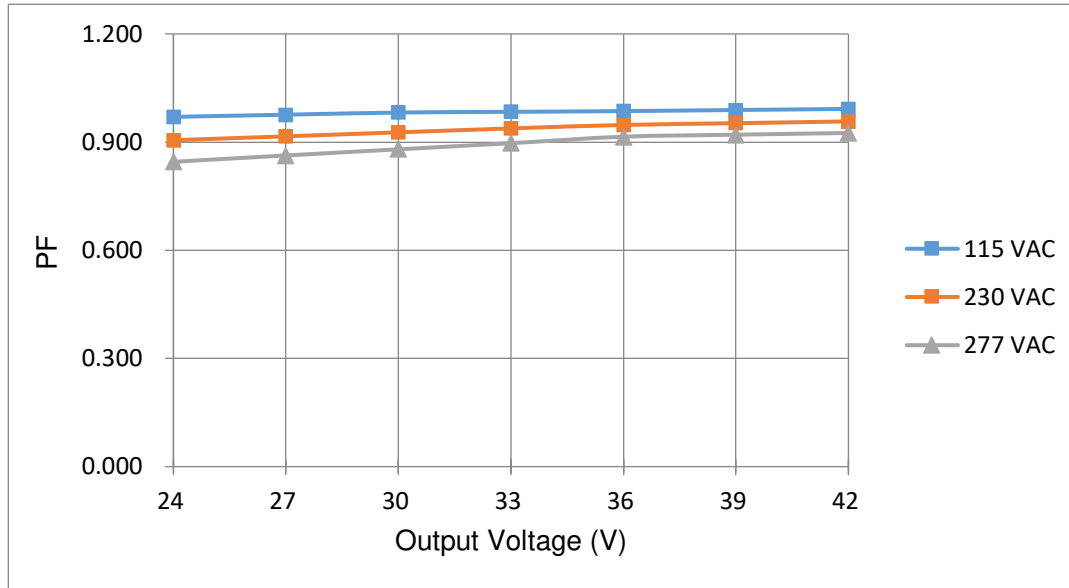

NOTE: **1.** Datasheets are updated as needed and as such, specifications are subject to change without notice. Once printed or downloaded, datasheets are no longer controlled by Aimtec; refer to www.aimtec.com for the most current product specifications. **2.** Product labels shown, including safety agency certifications on labels, may vary based on the date manufactured. **3.** Mechanical drawings and specifications are for reference only. **4.** All specifications are measured at an ambient temperature of 25°C, humidity < 75%, nominal input voltage and at rated output load unless otherwise specified. **5.** Aimtec may not have conducted destructive testing or chemical analysis on all internal components and chemicals at the time of publishing this document. CAS numbers and other limited information are considered proprietary and may not be available for release. **6.** This product is not designed for use in critical life support systems, equipment used in hazardous environments, nuclear control systems or other such applications which necessitate specific safety and regulatory standards other than the ones listed in this datasheet. **7.** Warranty is in accordance with Aimtec's standard Terms of Sale available at www.aimtec.com.