

## SiC MOS P3M07013K4 N-Channel Enhancement Mode

### Features

- High Blocking Voltage with Low On-Resistance
- High-Frequency Operation
- Ultra-Small  $Q_{gd}$
- 100% UIS tested

### Benefits

- Improve System Efficiency
- Increase Power Density
- Reduce Heat Sink Requirements
- Reduction of System Cost

### Applications

- Solar Inverters
- EV Battery Chargers
- High Voltage DC/DC Converters
- Switch Mode Power Supplies

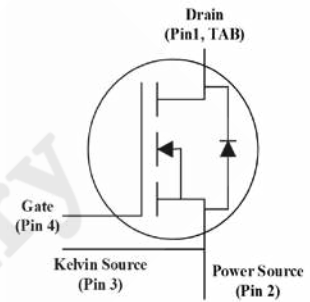

TO-247-4

Drain	1
Power Source	2
Kelvin Source	3
Gate	4



### Order Information

Part Number	Package	Marking
P3M07013K4	TO-247-4	P3M07013K4

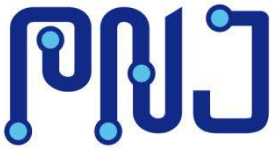

## Contents

Features.....	1
Benefits.....	1
Applications.....	1
Order Information .....	1
<b>Contents.....</b>	<b>2</b>
1. Maximum Ratings.....	3
2. Electrical Characteristics .....	4
3. Reverse Diode Characteristics.....	6
4. Thermal Characteristics.....	6
5. Typical Performance .....	7
6. Definitions .....	11
7. Package Outlines.....	12

PNJ Preliminary



## 1. Maximum Ratings

At  $T_J = 25^\circ\text{C}$ , unless specified otherwise

Parameter	Symbol	Value	Unit	Test Conditions
Drain - Source Voltage	$V_{DSmax}$	750	V	$V_{GS} = -3\text{V}$ $I_D = 100\mu\text{A}$
Gate - Source Voltage (dynamic)	$V_{GSmax}$	-8 / +19	V	AC ( $f > 1\text{ Hz}$ )
Gate - Source Voltage(static) turn-on gate voltage	$V_{GS,on}$	+15	V	Static
turn-off gate voltage	$V_{GS,off}$	-3		
Continuous Drain Current	$I_D$	140	A	$V_{GS} = 15\text{V}$ $T_C = 25^\circ\text{C}$
		100		$V_{GS} = 15\text{V}$ $T_C = 100^\circ\text{C}$
Power Dissipation	$P_D$	428	W	
Operating Junction	$T_J$	-55 To +175	$^\circ\text{C}$	
Storage Temperature	$T_{stg}$	-55 To +175	$^\circ\text{C}$	
Solder Temperature	$T_L$	260	$^\circ\text{C}$	
Mounting Torque	$M_d$	1 8.8	Nm lbf-in	M3 or 6-32 screw



## 2. Electrical Characteristics

At  $T_J = 25^\circ\text{C}$ , unless specified otherwise

Parameter	Symbol	Value			Unit	Test Conditions
		Min.	Typ.	Max.		
Drain-Source Breakdown Voltage	$V_{(BR)DSS}$	750	/	/	V	$V_{GS} = -3\text{V}$ $I_D = 100\mu\text{A}$
Gate Threshold Voltage	$V_{GS(th)}$	1.8	2.2	/	V	(tested after 30ms pulse at $V_{GS} = 15\text{V}$ ) $V_{DS} = V_{GS}$ $I_D = 75\text{mA}$ $T_J = 25^\circ\text{C}$
		/	1.65	/	V	$V_{DS} = V_{GS}$ $I_D = 75\text{mA}$ $T_J = 175^\circ\text{C}$
Reverse Bias Drain Current	$I_{DSS}$	/	1	10	$\mu\text{A}$	$V_{GS} = -3\text{V}$ $V_{DS} = 750\text{V}$
Gate-Source Leakage Current	$I_{GSS}$	/	20	250	nA	$V_{GS} = 15\text{V}$ $V_{DS} = 0\text{V}$
Drain-Source On-State Resistance	$R_{DS(on)}$	/	13	16	m $\Omega$	$V_{GS} = 15\text{V}$ $I_D = 75\text{A}$ $T_J = 25^\circ\text{C}$
		/	13	/		$V_{GS} = 15\text{V}$ $I_D = 75\text{A}$ $T_J = 125^\circ\text{C}$
			14			$V_{GS} = 15\text{V}$ $I_D = 75\text{A}$ $T_J = 175^\circ\text{C}$

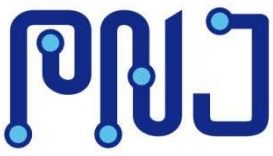

# P3M07013K4 SiC MOS N-Channel Enhancement Mode

Parameter	Symbol	Value			Unit	Test Conditions
		Min.	Typ.	Max.		
Trans conductance	g <sub>fs</sub>	/	41	/	S	V <sub>DS</sub> = 20V I <sub>DS</sub> = 75A T <sub>J</sub> = 25°C
		/	45	/		V <sub>DS</sub> = 20V I <sub>DS</sub> = 75A T <sub>J</sub> = 175°C
Input Capacitance	C <sub>iss</sub>	/	9942	/	pF	V <sub>GS</sub> = 0V V <sub>DS</sub> = 500V f= 100KHz V <sub>AC</sub> = 25mV
Output Capacitance	C <sub>oss</sub>	/	475	/		
Reverse Transfer Capacitance	C <sub>rss</sub>	/	28	/		
Coss Stored Energy	E <sub>oss</sub>	/	143	/	μJ	
Turn-on Energy	E <sub>on</sub>	/	762	/	μJ	V <sub>DS</sub> = 500V V <sub>GS</sub> = -3/15V I <sub>D</sub> = 75A R <sub>G</sub> = 1Ω
Turn-off Energy	E <sub>off</sub>	/	294	/		
Turn-On Delay Time	t <sub>d(on)</sub>	/	25	/	ns	V <sub>DS</sub> = 500V V <sub>GS</sub> = -3/15V I <sub>D</sub> = 75A R <sub>G</sub> = 1Ω
Rise Time	t <sub>r</sub>	/	43	/		
Turn-Off Delay Time	t <sub>d(off)</sub>	/	52	/		
Fall Time	t <sub>f</sub>	/	14	/		
Internal Gate Resistance	R <sub>G(int)</sub>	/	1.43	/	Ω	f= 1MHz V <sub>AC</sub> = 25mV
Gate to Source Charge	Q <sub>gs</sub>	/	93.6	/	nC	V <sub>DS</sub> = 500V I <sub>DS</sub> = 75A V <sub>GS</sub> = -3/15V I <sub>G</sub> = 20mA
Gate to Drain Charge	Q <sub>gd</sub>	/	44	/		
Total Gate Charge	Q <sub>g</sub>	/	250.3	/		

### 3. Reverse Diode Characteristics

At  $T_J = 25^\circ\text{C}$ , unless specified otherwise

Parameter	Symbol	Value		Unit	Test Conditions
		Typ.	Max.		
Diode Forward Voltage	$V_{SD}$	4.4	/	V	$V_{GS} = -3\text{V}$ $I_{SD} = 37.5\text{A}$ $T_J = 25^\circ\text{C}$
		4.0	/	V	$V_{GS} = -3\text{V}$ $I_{SD} = 37.5\text{A}$ $T_J = 175^\circ\text{C}$
Continuous Diode Forward Current	$I_S$	82	/	A	$V_{GS} = -3\text{V}$
Reverse Recover Time	$t_{rr}$	22	/	ns	$V_{GS} = -3\text{V}$ $I_{SD} = 75\text{A}$ $V_R = 500\text{V}$ $dI/dt = 3500\text{A}/\mu\text{s}$ $T_J = 25^\circ\text{C}$
Reverse Recovery Charge	$Q_{rr}$	618	/	nC	
Peak Reverse Recovery Current	$I_{rrm}$	46	/	A	

### 4. Thermal Characteristics

Parameter	Symbol	Value	Unit
Thermal Resistance from Junction to Case	$R_{\theta JC}$	0.34	$^\circ\text{C}/\text{W}$

## 5. Typical Performance

At  $T_J = 25^\circ\text{C}$ , unless specified otherwise

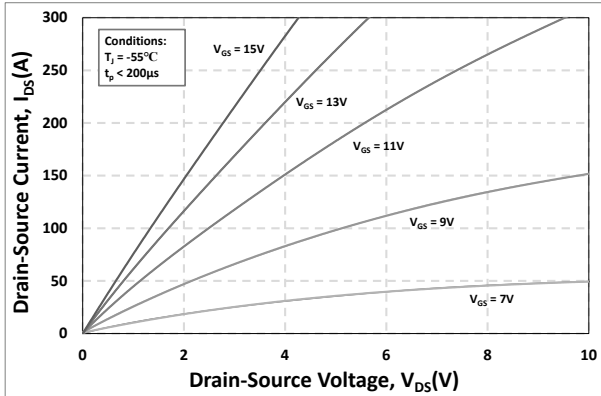

Figure 1. Output Characteristics  $T_J = -55^\circ\text{C}$

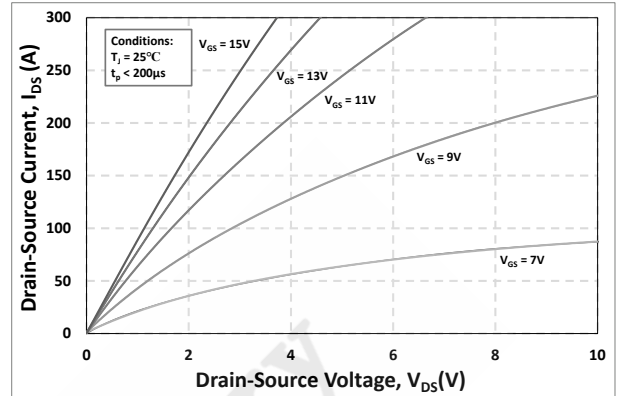

Figure 2. Output Characteristics  $T_J = 25^\circ\text{C}$

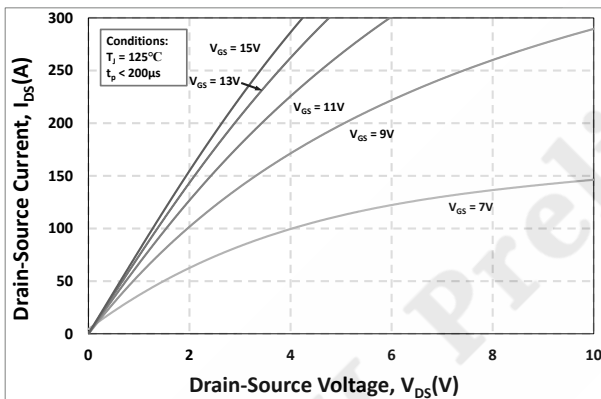

Figure 3. Output Characteristics  $T_J = 125^\circ\text{C}$

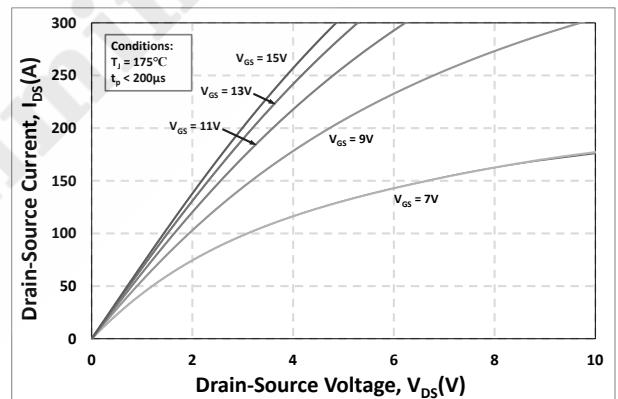

Figure 4. Output Characteristics  $T_J = 175^\circ\text{C}$

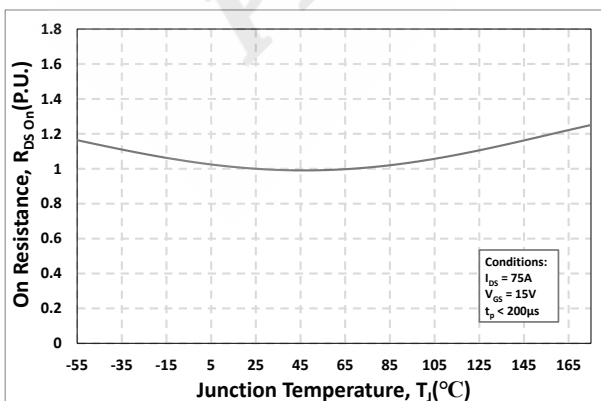

Figure 5. Normalized On-Resistance vs. Temperature

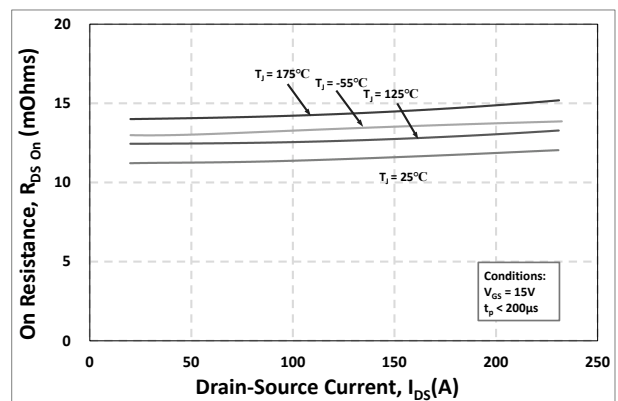

Figure 6. On-Resistance vs. Drain Current Various Temperatures

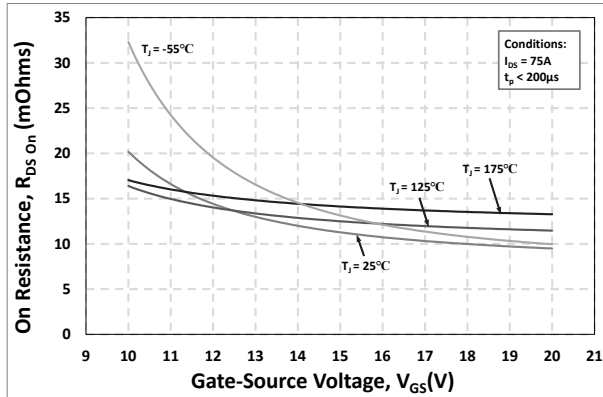

Figure 7. On-Resistance vs. Gate-Source Voltage

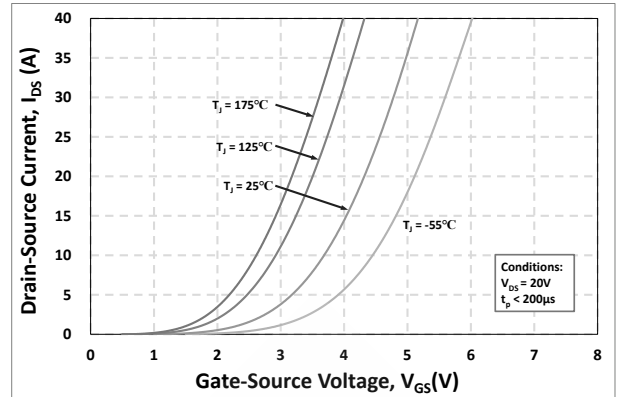

Figure 8. Transfer Characteristic for Various Junction Temperatures

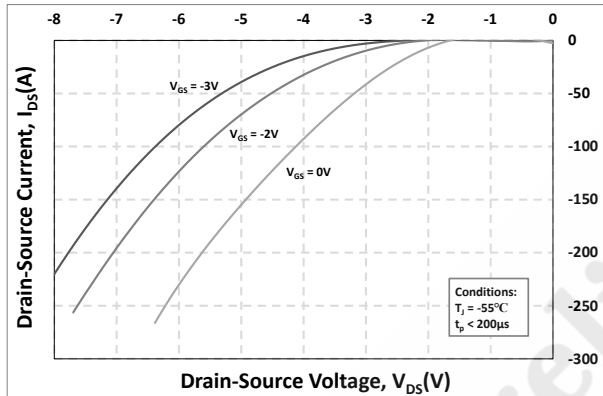

Figure 9. Body Diode Characteristic at -55°C

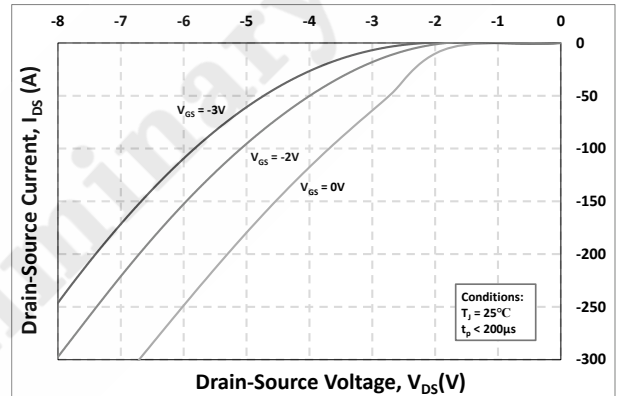

Figure 10. Body Diode Characteristic at 25°C

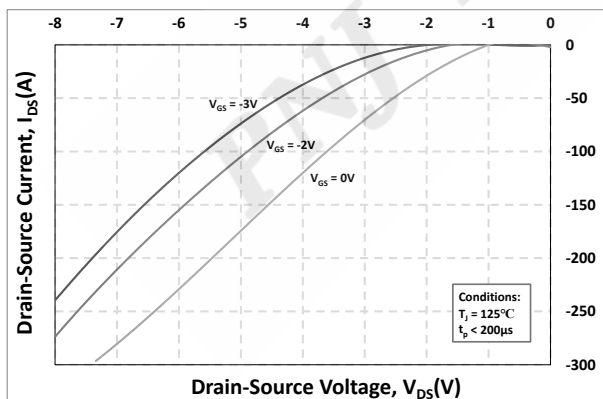

Figure 11. Body Diode Characteristic at 125°C

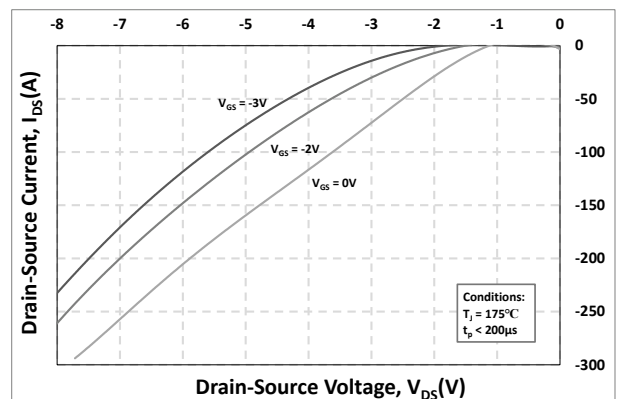

Figure 12. Body Diode Characteristic at 175°C



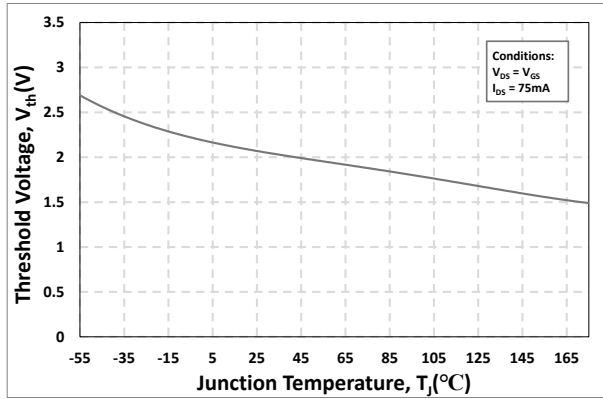

Figure 13. Threshold Voltage vs. Temperature

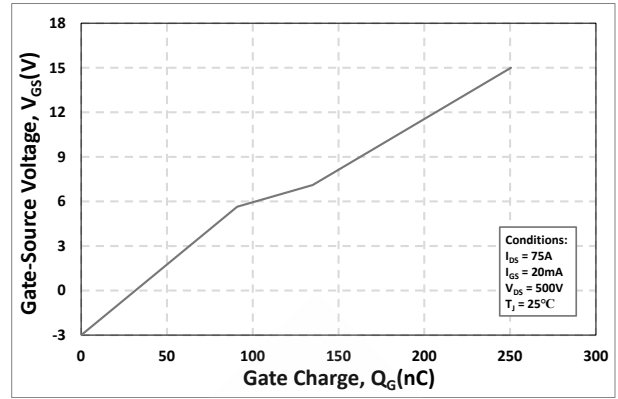

Figure 14. Gate Charge Characteristics

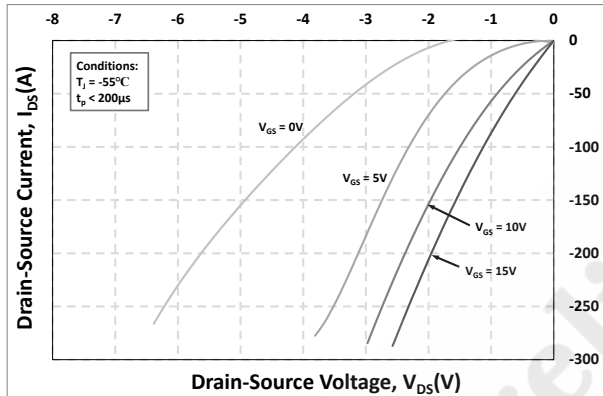

Figure 15. 3rd Quadrant Characteristic at -55°C

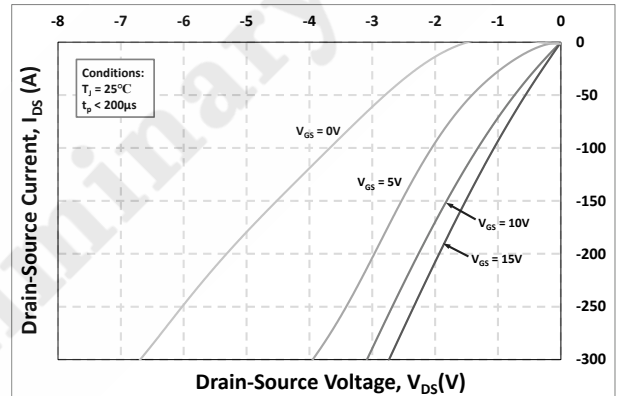

Figure 16. 3rd Quadrant Characteristic at 25°C

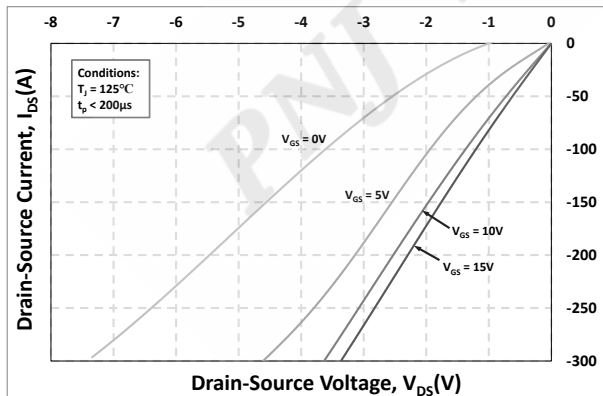

Figure 17. 3rd Quadrant Characteristic at 125°C

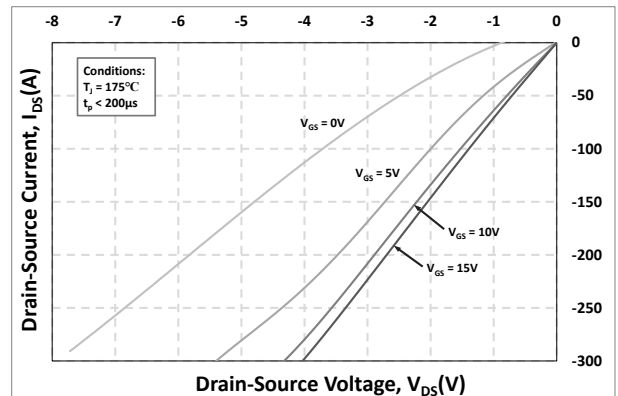

Figure 18. 3rd Quadrant Characteristic at 175°C

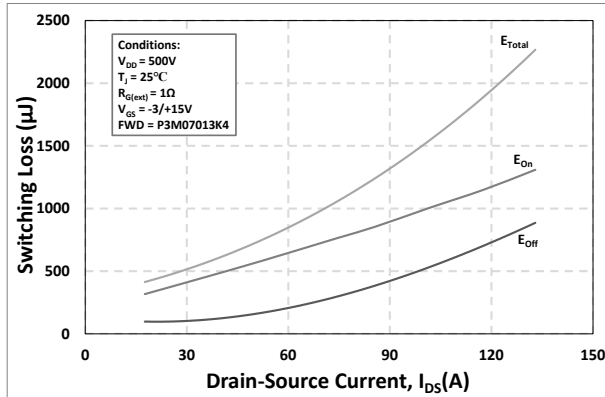

Figure 19. Clamped Inductive Switching Energy vs. Drain Current ( $V_{DD} = 500V$ )

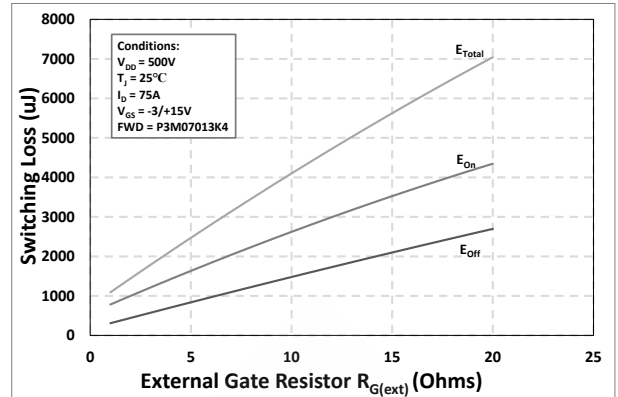

Figure 20. Clamped Inductive Switching Energy vs.  $R_{G(ext)}$

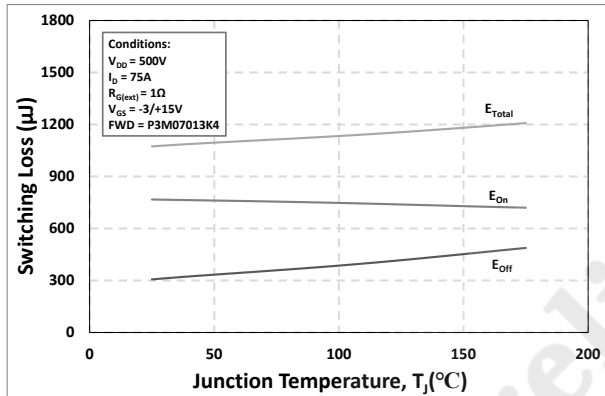

Figure 21. Clamped Inductive Switching Energy vs. Temperature

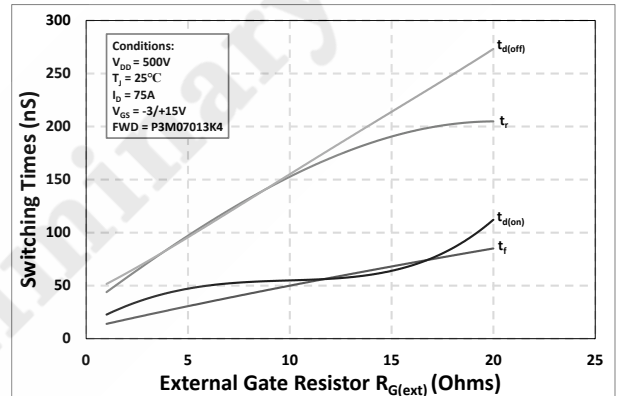

Figure 22. Switching Times vs.  $R_{G(ext)}$

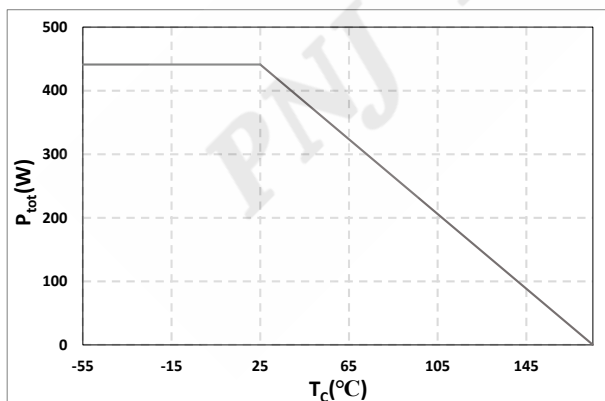

Figure 23. Maximum Power Dissipation Derating vs. Case Temperature

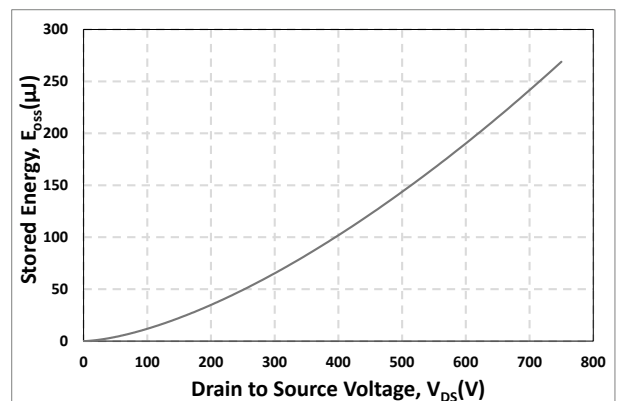

Figure 24. Output Capacitor Stored Energy

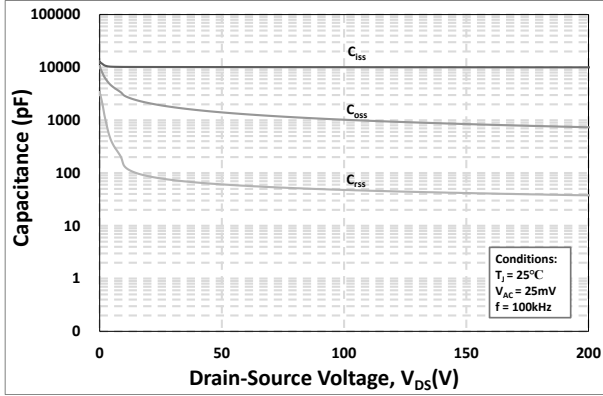

Figure 25. Capacitances vs. Drain-Source Voltage (0 - 200V)

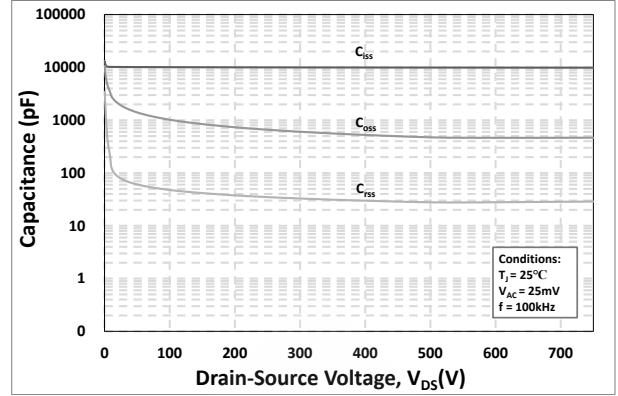

Figure 26. Capacitances vs. Drain-Source Voltage (0 - 750V)

## 6. Definitions

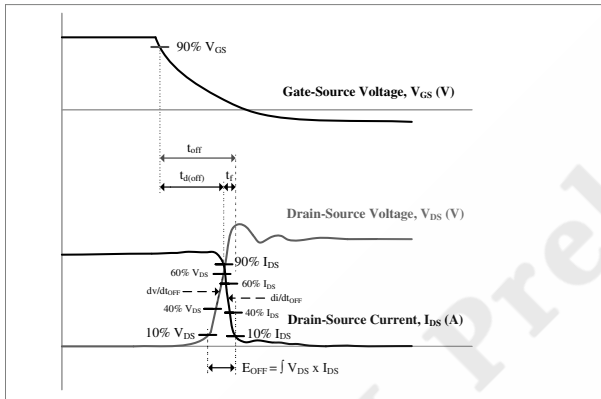

Figure 27. Turn-off Transient Definitions

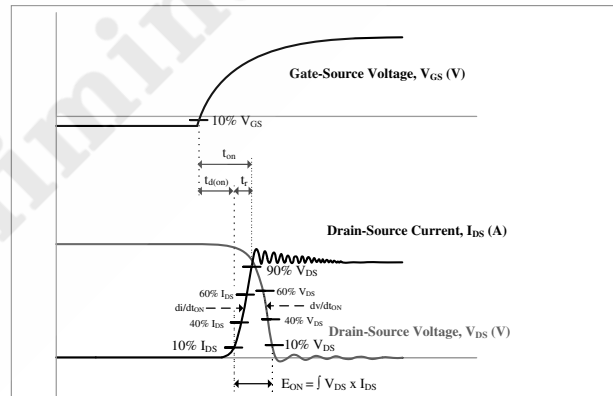

Figure 28. Turn-on Transient Definitions

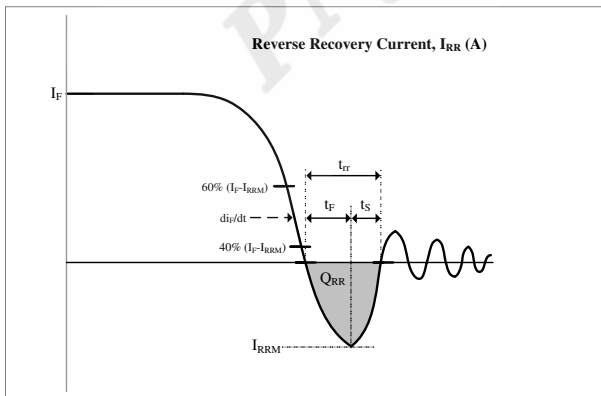

Figure 29. Reverse Recovery Definitions

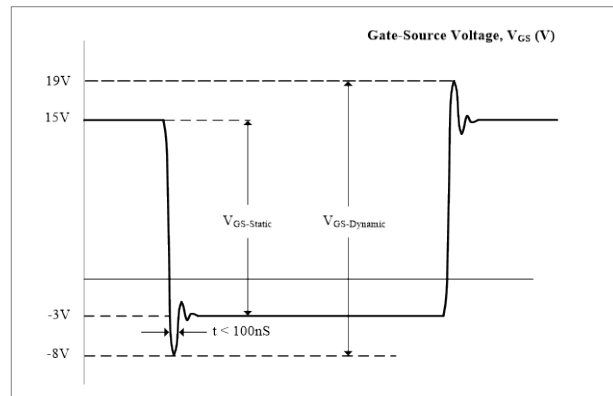
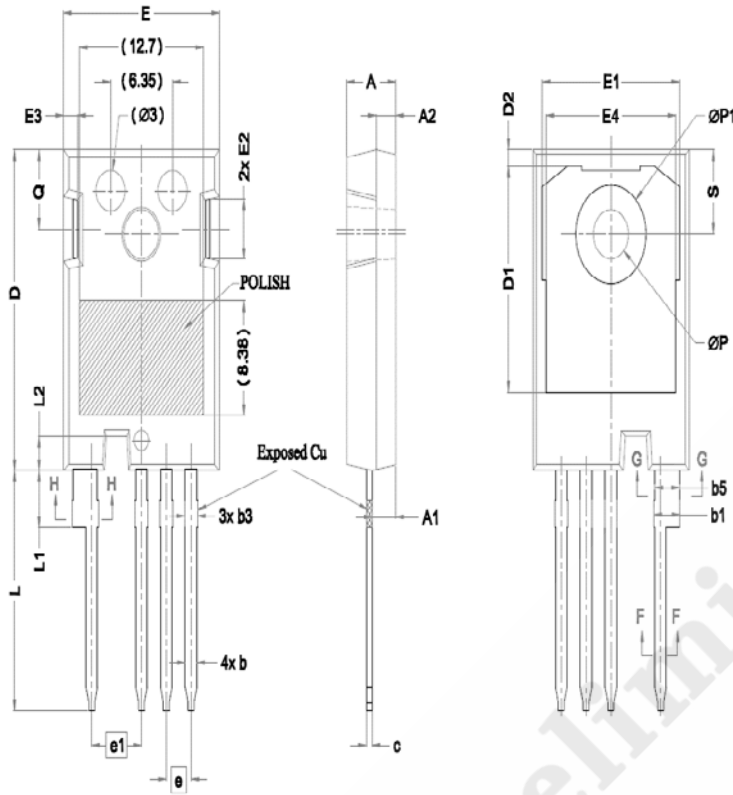

Figure 30. vgs Transient Definitions

## 7. Package Outlines



Symbol	Dimensions		
	Min.	Nom.	Max.
A	4.83	5.02	5.21
A1	2.28	2.41	2.54
A2	1.91	2.00	2.16
b <sup>1</sup>	1.07	1.20	1.28
b	1.07	1.20	1.33
b1	2.39	2.67	2.94
b2	2.39	2.67	2.84
b3	1.07	1.30	1.60
b4	1.07	1.30	1.50
b5	2.39	2.53	2.69
b6	2.39	2.53	2.64
c	0.55	0.60	0.68
e1	0.55	0.60	0.65
D	22.30	23.45	23.80
D1	16.25	16.55	17.65
D2	0.95	1.19	1.25
E	15.75	15.94	16.13
E1	13.10	14.02	14.15
E2	3.60	1.10	5.10
E3	1.00	1.45	1.90
E4	12.38	13.26	13.43
e	2.54BSC		
e1	5.08BSC		
L	17.31	17.57	17.82
L1	3.97	4.19	4.37
L2	2.35	2.50	2.65
ØP	3.51	3.61	3.65
ØP	7.19 REF.		
Q	5.49	5.79	6.00
S	6.04	6.17	6.30

Drawing and Dimensions

PNJ Preliminary

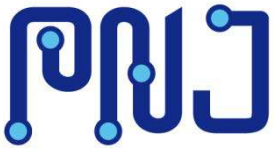

## Important Notice

---

The information given in this document shall in no event be regarded as a guarantee of conditions or characteristics. With respect to any examples, hints or any typical values stated herein and/or any information regarding the application of the product, PN Junction hereby disclaims any and all warranties and liabilities of any kind, including without limitation warranties of non-infringement of intellectual property rights of any third party.

PN Junction reserves the right to make changes at any time to any products or information herein, without notice. “Typical” parameters which may be provided in PN Junction data sheets and/or specifications can and do vary in different applications and actual performance may vary over time. All operating parameters, including “Typical” must be validated for each customer application by customer’s technical experts.

In addition, any information given in this document is subject to customer’s compliance with its obligations stated in this document and any applicable legal requirements, norms and standards concerning customer’s products and any use of the product of PN Junction in customer’s applications. The data contained in this document is exclusively intended for technically trained staff. It is the responsibility of customer’s technical departments to evaluate the suitability of the product for the intended application and the completeness of the product information given in this document with respect to such application.

For further information on the product, technology, delivery terms and conditions and prices please contact your nearest PN Junction office ([www.pnjsemi.com](http://www.pnjsemi.com)).

## Warnings

---

Due to technical requirements products may contain dangerous substances. For information on the types in question please contact your nearest PN Junction office.

Except as otherwise explicitly approved by PN Junction in a written document signed by authorized representatives of PN Junction, PN Junction’s products may not be used in any applications where a failure of the product or any consequences of the use thereof can reasonably be expected to result in personal injury.