



LUXEON 3535L Line

High efficacy in a 3535 package with full range of CCTs and CRIs

The LUXEON 3535L Line delivers optimized performance in combination with the Quality of Light needed for distributed light source applications. In addition to offering specified correlated color temperature and color rendering combinations, LUXEON 3535L Line is available in three performance levels. These LEDs boast the efficacy and reliability required by the indoor and outdoor illumination markets.



FEATURES AND BENEFITS

- Supports ENERGY STAR lumen maintenance certification requirements
- Maximum drive current of 200mA delivers superior lumens for reduced LED count
- 1/7th ANSI color binning delivers tight color control
- Enables T_s points of 105°C which allows for higher board temperature
- Full range of CCTs and CRI configurations for design flexibility
- UL-recognized component [E352519]

PRIMARY APPLICATIONS

- Architectural
- Downlights
- High Bay & Low Bay
- Indoor Area Lighting
- Lamps
- Specialty Lighting
- Spotlights

Table of Contents

General Product Information	2
Product Test Conditions	2
Part Number Nomenclature	2
Lumen Maintenance	2
Environmental Compliance	2
Performance Characteristics	3
Product Selection Guide	3
Optical Characteristics	4
Thermal Characteristics	4
Absolute Maximum Ratings	4
Characteristic Curves	5
Spectral Power Distribution Characteristics	5
Light Output Characteristics	6
Forward Current Characteristics	7
Radiation Pattern Characteristics	8
Efficacy Characteristics	9
Product Bin and Labeling Definitions	10
Decoding Product Bin Labeling	10
Luminous Flux Bins	10
Color Bin Definitions	11
Forward Voltage Bins	20
Mechanical Dimensions	20
Reflow Soldering Guidelines	21
JEDEC Moisture Sensitivity	21
Solder Pad Design	22
Packaging Information	22
Pocket Tape Dimensions	22
Reel Dimensions	23

General Product Information

Product Test Conditions

LUXEON 3535L Line LEDs are tested and binned with a 20ms monopulse of 100mA at a junction temperature, T_j , of 25°C.

Part Number Nomenclature

Part numbers for LUXEON 3535L Line follow the convention below:

M X A **B** - P W **C C** - **D E E E**

Where:

- B** – designates minimum CRI (7=70CRI, 8=80CRI and 9=85CRI or 90CRI)
- C C** – designates nominal ANSI CCT (30=3000K and 40=4000K)
- D** – designates product family in standard parts (0 or 9=LUXEON 3535L, S=LUXEON 3535LS)
- E E E** – designates options for detailed product specification

Therefore, the following part number is used for a LUXEON 3535L 3000K 80CRI:

M X A **8** - P W **3 0** - **0 0 0 1**

Lumen Maintenance

Please contact your local Sales Representative or Lumileds Technical Solutions Manager for more information about the long-term performance of this product.

Environmental Compliance

Lumileds LLC is committed to providing environmentally friendly products to the solid-state lighting market. LUXEON 3535L Line is compliant to the European Union directives on the restriction of hazardous substances in electronic equipment, namely the RoHS Directive 2011/65/EU and REACH Regulation (EC) 1907/2006. Lumileds LLC will not intentionally add the following restricted materials to its products: lead, mercury, cadmium, hexavalent chromium, polybrominated biphenyls (PBB) or polybrominated diphenyl ethers (PBDE).

Performance Characteristics

Product Selection Guide

Table 1. Product performance of LUXEON 3535L Line at 100mA and 65mA, T_j=25°C.

PRODUCT	NOMINAL CCT ^[1]	MINIMUM CRI ^[2]	LUMINOUS FLUX ^[3] (lm)		TYPICAL LUMINOUS EFFICACY (lm/W)	TYPICAL LUMINOUS FLUX (lm)	TYPICAL LUMINOUS EFFICACY (lm/W)	PART NUMBER
			MINIMUM	TYPICAL				
						100mA		
LUXEON 3535LS	4000K	70	38	44	147	30	158	MXA7-PW40-S001
	5000K	70	38	44	147	30	158	MXA7-PW50-S001
	5700K	70	38	44	147	30	158	MXA7-PW57-S001
	6500K	70	38	46	154	31	166	MXA7-PW65-S001
	2200K	80	26	30	100	20	108	MXA8-PW22-S001
	2500K	80	26	32	107	22	116	MXA8-PW25-S001
	2700K	80	30	38	127	26	137	MXA8-PW27-S001
	3000K	80	30	39	130	26	141	MXA8-PW30-S001
	3500K	80	30	41	137	28	148	MXA8-PW35-S001
	4000K	80	34	43	144	29	155	MXA8-PW40-S001
	5000K	80	34	43	144	29	155	MXA8-PW50-S001
	5700K	80	30	42	140	28	151	MXA8-PW57-S001
	6500K	80	30	42	140	28	151	MXA8-PW65-S001
	2700K	85	30	33	110	22	119	MXA9-PW27-S111
	4000K	85	24	32	107	22	116	MXA9-PW40-S111
	2700K	90	26	32	107	22	116	MXA9-PW27-S001
	3000K	90	26	32	107	22	116	MXA9-PW30-S001
	LUXEON 3535L	4000K	70	40	49	161	33	176
5000K		70	40	49	161	33	176	MXA7-PW50-0000
5700K		70	40	49	161	33	176	MXA7-PW57-0000
6500K		70	40	47	155	32	168	MXA7-PW65-0000
2200K		80	28	33	109	22	117	MXA8-PW22-0000
2500K		80	28	34	112	23	121	MXA8-PW25-0000
2700K		80	36	44	145	30	156	MXA8-PW27-0000
3000K		80	34	44	145	30	156	MXA8-PW30-0000
3500K		80	34	44	145	30	156	MXA8-PW35-0000
4000K		80	36	46	151	31	163	MXA8-PW40-0000
5000K		80	36	47	155	32	167	MXA8-PW50-0000
5700K		80	36	45	148	30	160	MXA8-PW57-0000
6500K		80	36	45	148	30	160	MXA8-PW65-0000
2700K		85	32	36	119	24	128	MXA9-PW27-0000
4000K		85	34	40	132	27	142	MXA9-PW40-0000
2700K		90	31	36	119	24	128	MXA9-PW27-9000
3000K		90	31	36	119	24	128	MXA9-PW30-0000

Notes for Table 1:

1. Correlated color temperature is based upon mounted die on highly reflective surface at T_j=25°C.
2. Typical CRI is approximately 2 points higher than the minimum CRI specified, but this is not guaranteed.
3. Lumileds maintains a tolerance of ±2 on CRI and ±6.5% on luminous flux measurements.

Optical Characteristics

Table 2. Optical characteristics for LUXEON 3535L Line at 100mA, T_j=25°C.

PART NUMBER	TYPICAL TOTAL INCLUDED ANGLE ^[1]	TYPICAL VIEWING ANGLE ^[2]
MXAx-xxxx-xxxx	140°	115°

Notes for Table 2:

- Total angle at which 90% of total luminous flux is captured.
- Viewing angle is the off axis angle from the LED centerline where the luminous intensity is ½ of the peak value.

Thermal Characteristics

Table 3. Electrical and thermal characteristics for LUXEON 3535L Line at 100mA, T_j=25°C.

PART NUMBER	FORWARD VOLTAGE ^[1] (V _f)			TYPICAL TEMPERATURE COEFFICIENT OF FORWARD VOLTAGE (mV/°C) ^[2]	TYPICAL THERMAL RESISTANCE — JUNCTION TO SOLDER PAD (°C/W)
	MINIMUM	TYPICAL	MAXIMUM		
MXAx-PWxx-S001	2.8	3.0	3.4	-2.0 to -4.0	22
MXAx-PWxx-0000	2.8	3.0	3.4	-2.0 to -4.0	18

Notes for Table 3:

- Lumileds maintains a tolerance of ±0.06V on forward voltage measurements.
- Measured between 25°C and 110°C.

Absolute Maximum Ratings

Table 4. Absolute maximum ratings for LUXEON 3535L Line.

PARAMETER	MAXIMUM PERFORMANCE
DC Forward Current ^[1,2]	200mA
Peak Pulsed Forward Current ^[1,3]	240mA
LED Junction Temperature ^[1] (DC & Pulse)	125°C
ESD Sensitivity (ANSI/ESDA/JEDEC JS-001-2012)	Class 2
Operating Case Temperature ^[1]	-40°C to 105°C
LED Storage Temperature	-40°C to 105°C
Soldering Temperature	JEDEC 020D 260°C
Allowable Reflow Cycles	3
Reverse Voltage (V _{reverse}) ^[4,5]	-5V

Notes for Table 4:

- Residual periodic variations due to power conversion from alternating current (AC) to direct current (DC), also called "ripple," are acceptable if the following conditions are met:
 - The frequency of the ripple current is 100Hz or higher
 - The average current for each cycle does not exceed the maximum allowable DC forward current
 - The maximum amplitude of the ripple does not exceed the maximum peak pulsed forward current
- At 10% duty cycle with pulse width of 10ms.
- Proper current derating must be observed to maintain the junction temperature below the maximum allowable junction temperature.
- LUXEON 3535L LEDs are not designed to be driven in reverse bias.
- At maximum reverse current of 10µA.

Characteristic Curves

Spectral Power Distribution Characteristics

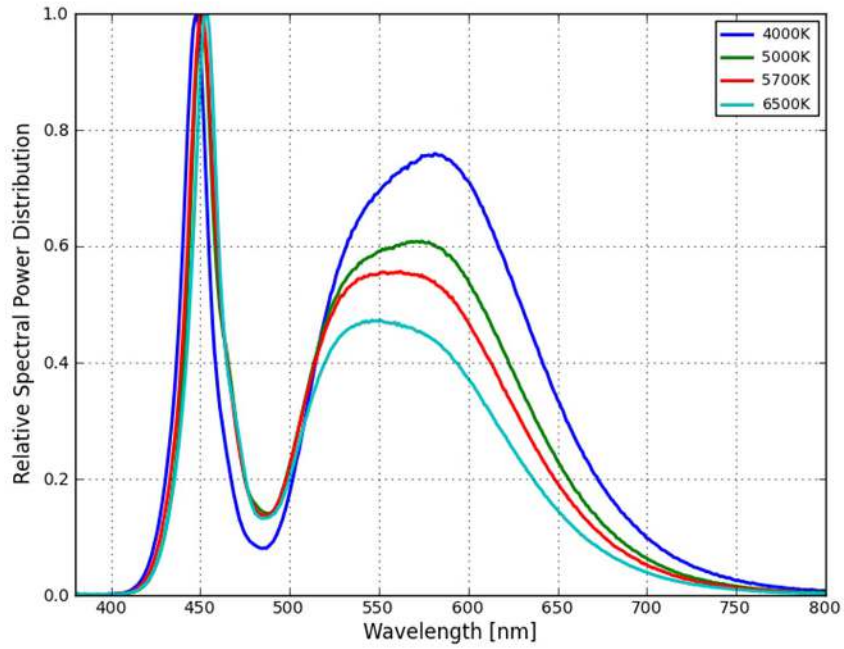

Figure 1a. Typical normalized power vs. wavelength for LUXEON 3535L 70CRI White at 100mA, $T_j=25^\circ\text{C}$.

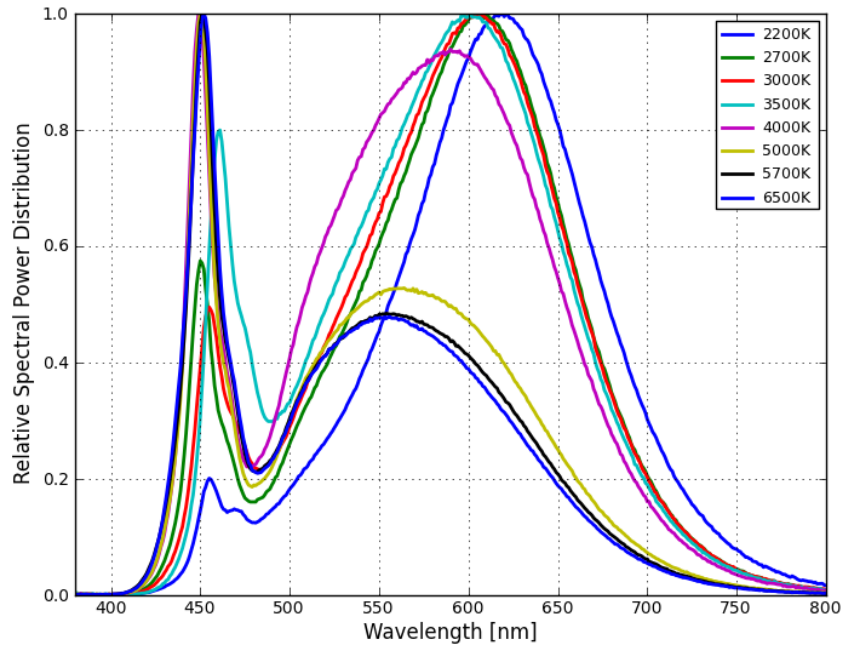

Figure 1b. Typical normalized power vs. wavelength for LUXEON 3535L 80CRI White at 100mA, $T_j=25^\circ\text{C}$.

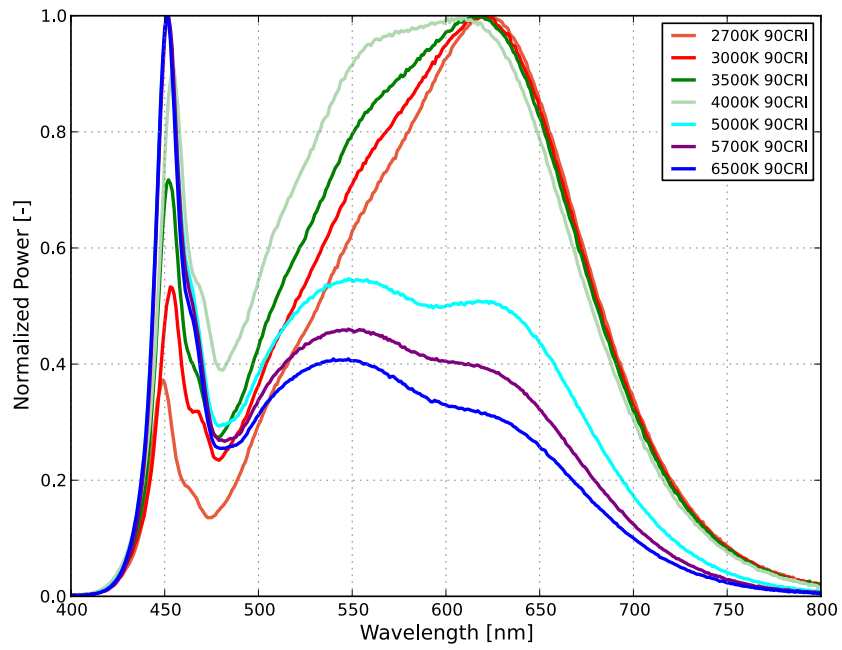

Figure 1c. Typical normalized power vs. wavelength for LUXEON 3535L 90CRI White at 100mA, $T_j=25^\circ\text{C}$.

Light Output Characteristics

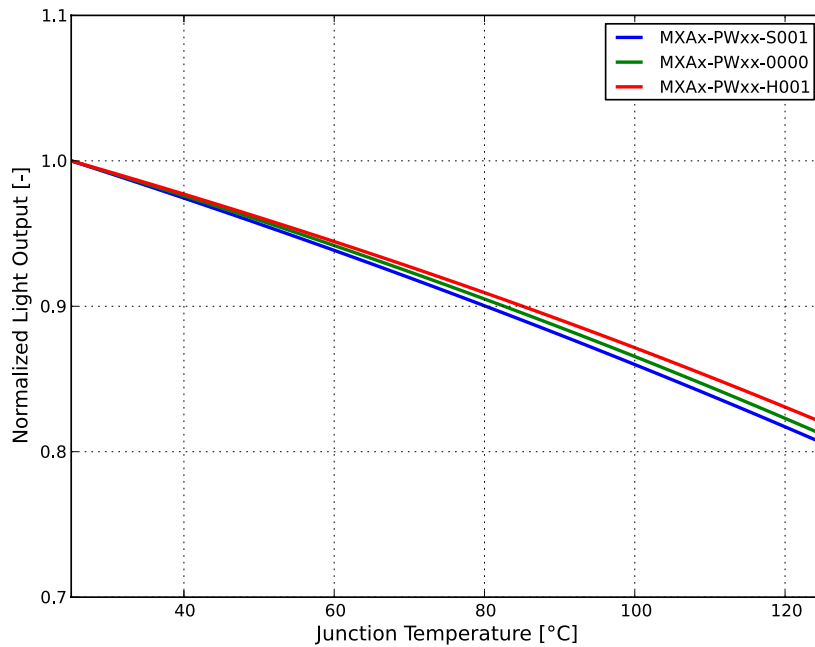

Figure 2. Typical normalized light output vs. junction temperature for MXAx-PWxx, $T_j=25^\circ\text{C}$.

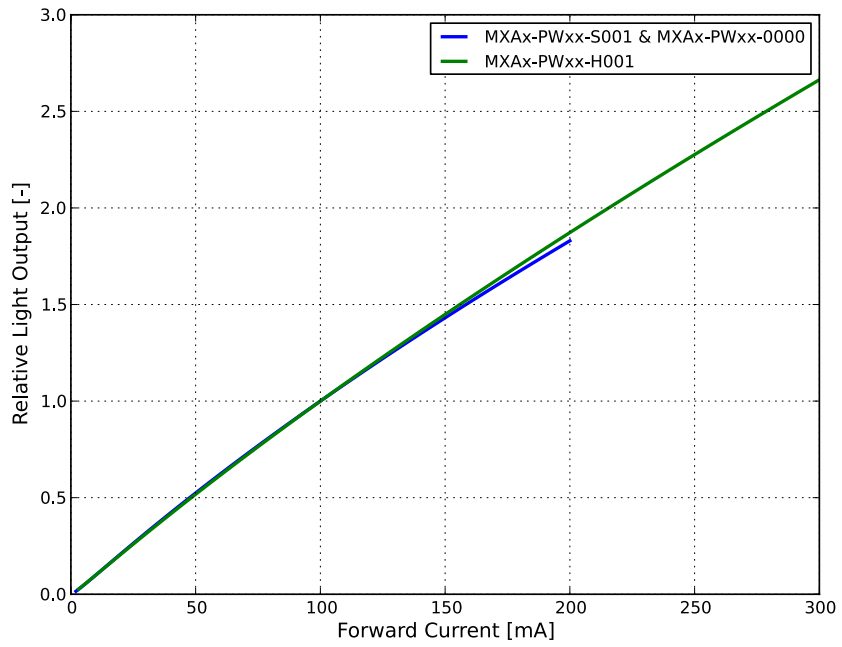

Figure 3. Typical normalized light output vs. forward current for MXAx-PWxx, $T_j=25^\circ\text{C}$.

Forward Current Characteristics

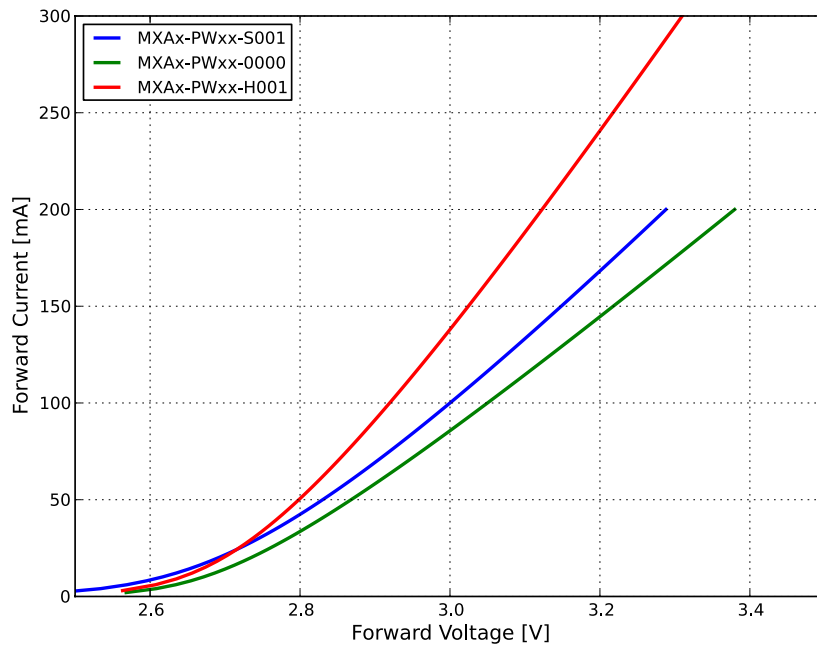

Figure 4. Typical forward current vs. forward voltage for MXAx-PWxx, $T_j=25^\circ\text{C}$.

Radiation Pattern Characteristics

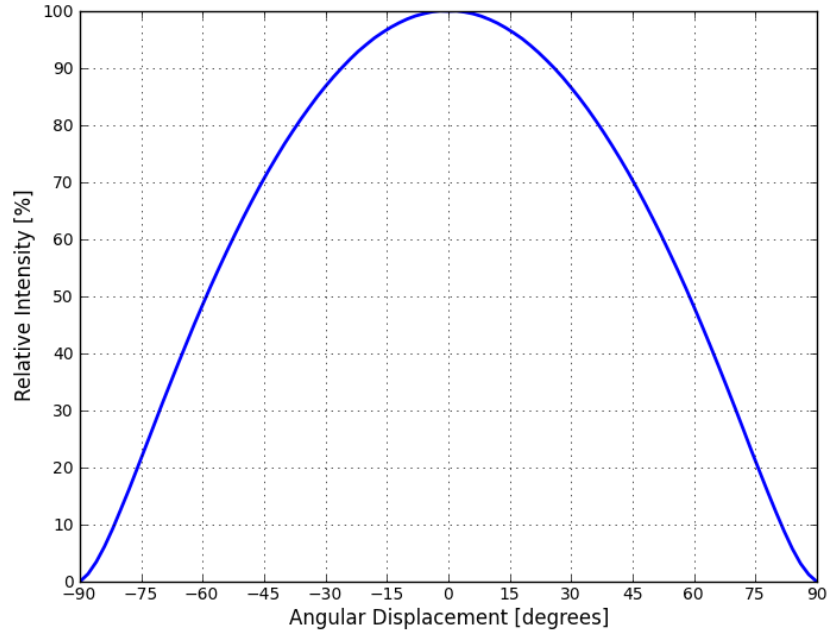

Figure 5. Typical radiation pattern for LUXEON 3535L at 100mA, $T_j=25^{\circ}\text{C}$.

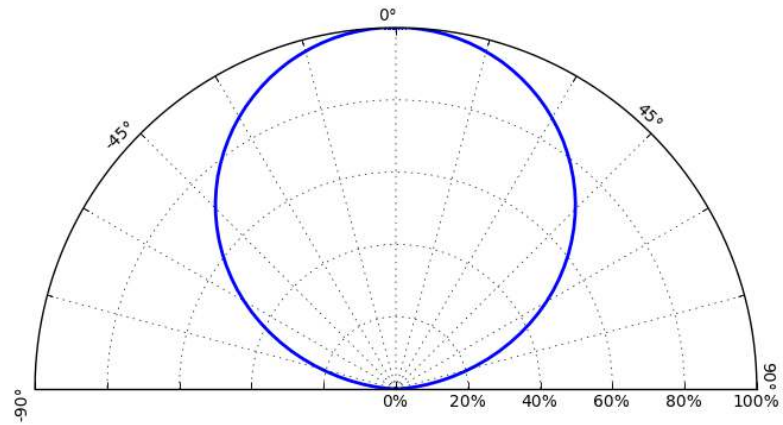

Figure 6. Typical polar radiation pattern for LUXEON 3535L at 100mA, $T_j=25^{\circ}\text{C}$.

Efficacy Characteristics

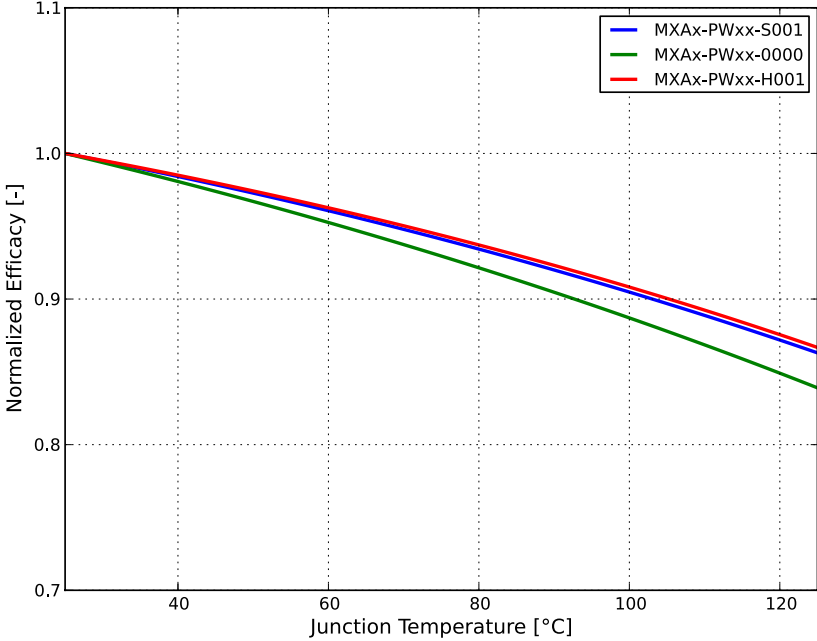

Figure 7. Typical normalized efficacy vs. forward current for MXAx-PWxx at 100mA, $T_j=25^{\circ}\text{C}$.

Product Bin and Labeling Definitions

Decoding Product Bin Labeling

In the manufacturing of semiconductor products, there are variations in performance around the average values given in the technical datasheet. For this reason, Lumileds bins LED components for luminous flux or radiometric power, color point, peak or dominant wavelength and forward voltage.

LUXEON 3535L Line LEDs are labeled using a 4 or 5-digit alphanumeric CAT code following the format below:

Where:

A B C D or **A x B C D**

- A** – designates luminous flux bin (example: M=36 to 40 lumens, R=48 to 52 lumens)
- x** – designates internal Lumileds code
- B C** – designates color bin (example: 7Z, 71, 72, 73, 74, 75, 76) for 3000K parts
- D** – designates forward voltage bin (example: S=2.70 to 2.80V, T=2.80 to 2.90V)

Therefore, a LUXEON 3535L with a lumen range of 48 to 52, color bin of 7Z and a forward voltage range of 2.70 to 2.80V has the following CAT code:

R 7 Z S

Luminous Flux Bins

Table 5 lists the standard photometric luminous flux bins for LUXEON 3535L Line emitters. Although several bins are outlined, product availability in a particular bin varies by production run and by product performance. Not all bins are available in all CCTs.

Table 5. Luminous flux bin definitions for LUXEON 3535L Line.

BIN	LUMINOUS FLUX ^[1] (lm)	
	MINIMUM	MAXIMUM
J	24	28
K	28	32
L	32	36
M	36	40
P	40	44
Q	44	48
R	48	52
S	52	56
T	56	60

Notes for Table 5:

1. Lumileds maintains a tolerance of $\pm 6.5\%$ on luminous flux measurements.

Color Bin Definitions

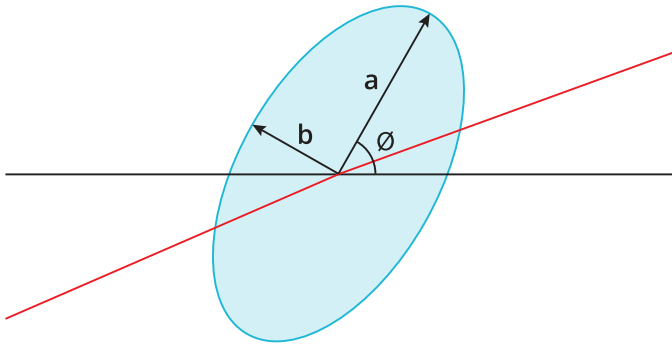

Figure 8. 3-step MacAdam ellipse illustration for Table 6.

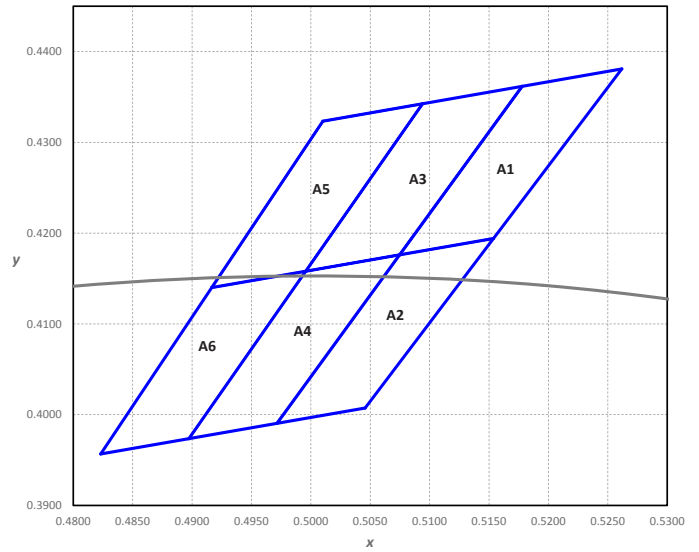

Figure 9a. Color bin structure for LUXEON 3535L Line 2200K.

Table 6a. Color bin definitions for LUXEON 3535L Line for MXAx-PW22-xxxx.

BIN	x	y	BIN	x	y
A1	0.5178	0.4362	A4	0.4996	0.4158
	0.5262	0.4381		0.5075	0.4176
	0.5154	0.4194		0.4972	0.3990
	0.5075	0.4176		0.4897	0.3974
A2	0.5075	0.4176	A5	0.5010	0.4323
	0.5154	0.4194		0.5094	0.4343
	0.5046	0.4007		0.4996	0.4158
	0.4972	0.3990		0.4917	0.4140
A3	0.5094	0.4343	A6	0.4917	0.4140
	0.5178	0.4362		0.4996	0.4158
	0.5075	0.4176		0.4897	0.3974
	0.4996	0.4158		0.4823	0.3957

Notes for Table 6a:

1. Lumileds maintains a tolerance of ± 0.007 on x and y coordinates in the CIE 1931 color space.
2. Tested and binned at 25°C and $I_f=100\text{mA}$.

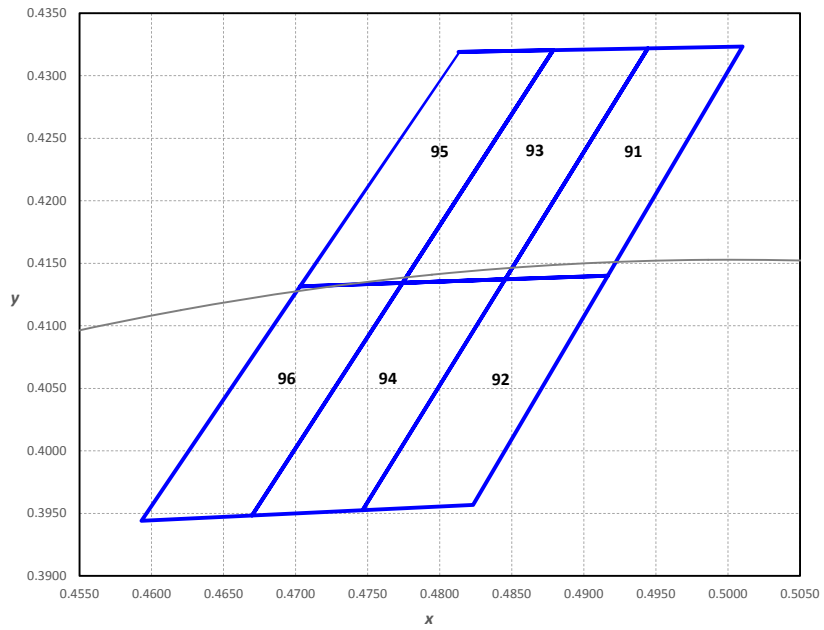

Figure 9b. Color bin structure for LUXEON 3535L Line 2500K.

Table 6b. Color bin definitions for LUXEON 3535L Line for MxAx-PW25-xxxx.

BIN	x	y	BIN	x	y
91	0.4944	0.4322	94	0.4774	0.4134
	0.5010	0.4323		0.4845	0.4137
	0.4917	0.4140		0.4746	0.3952
	0.4845	0.4137		0.4670	0.3948
92	0.4845	0.4137	95	0.4813	0.4319
	0.4917	0.4140		0.4879	0.4320
	0.4823	0.3957		0.4774	0.4134
	0.4746	0.3952		0.4703	0.4132
93	0.4879	0.4320	96	0.4703	0.4132
	0.4944	0.4322		0.4774	0.4134
	0.4845	0.4137		0.4670	0.3948
	0.4774	0.4134		0.4593	0.3944

Notes for Table 6b:

1. Lumileds maintains a tolerance of ± 0.007 on x and y coordinates in the CIE 1931 color space.
2. Tested and binned at 25°C and $I_f=100\text{mA}$.

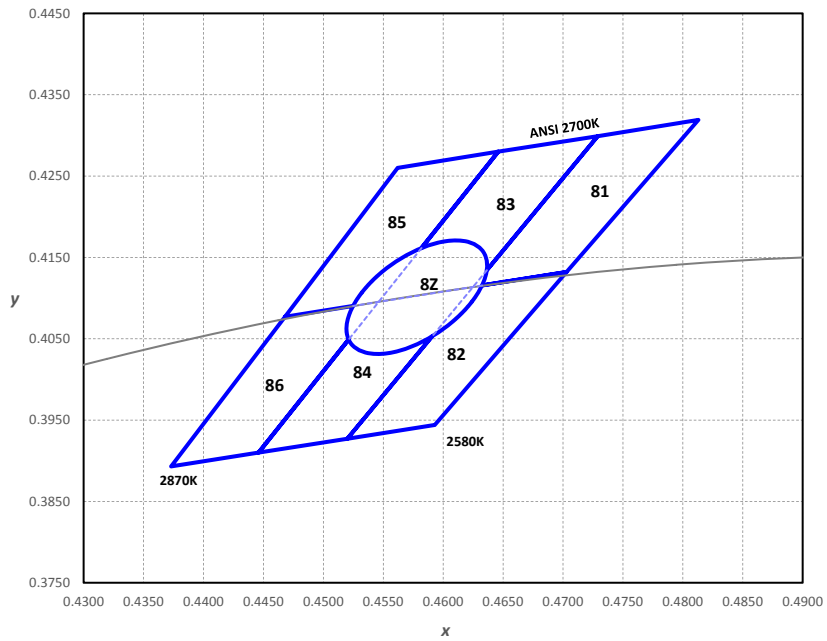

Figure 9c. Color bin structure for LUXEON 3535L Line 2700K.

Table 6c-1. Color bin definitions for LUXEON 3535L Line for MXAx-PW27-xxxx.

BIN	x	y	BIN	x	y
81	0.4625	0.4113	84	0.4446	0.3910
	0.4729	0.4299		0.4546	0.4095
	0.4813	0.4319		0.4625	0.4113
	0.4703	0.4132		0.4520	0.3927
82	0.4520	0.3927	85	0.4468	0.4077
	0.4625	0.4113		0.4562	0.4260
	0.4703	0.4132		0.4646	0.4280
	0.4593	0.3944		0.4546	0.4095
83	0.4546	0.4095	86	0.4373	0.3893
	0.4646	0.4280		0.4468	0.4077
	0.4729	0.4299		0.4546	0.4095
	0.4625	0.4113		0.4446	0.3910

Table 6c-2. Color bin definition for single 3-step MacAdam ellipse MXAx-PW27-xxxx.

COLOR SPACE	CENTER POINT (cx, cy)	MAJOR AXIS, a	MINOR AXIS, b	ELLIPSE ROTATION ANGLE, θ
8Z	(0.4578, 0.4101)	0.0081	0.0042	53.70°

Notes for Tables 6c-1 and 6c-2:

- Lumileds maintains a tolerance of ± 0.007 on x and y coordinates in the CIE 1931 color space.
- Tested and binned at 25°C and $I_f=100\text{mA}$.

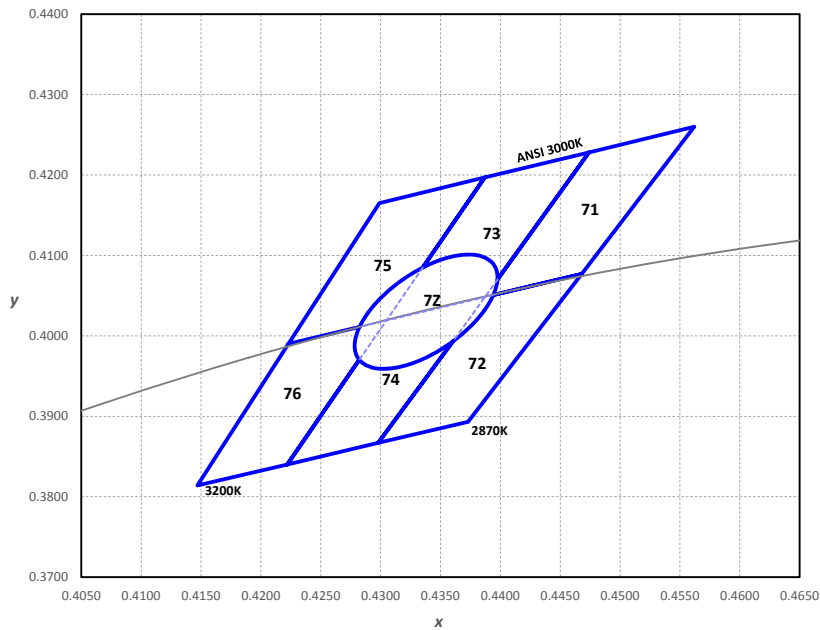

Figure 9d. Color bin structure for LUXEON 3535L Line 3000K.

Table 6d-1. Color bin definitions for LUXEON 3535L Line for MXAx-PW30-xxxx.

BIN	x	y	BIN	x	y
71	0.4386	0.4048	74	0.4222	0.3840
	0.4474	0.4228		0.4305	0.4019
	0.4562	0.4260		0.4386	0.4048
	0.4468	0.4077		0.4298	0.3867
72	0.4298	0.3867	75	0.4223	0.3990
	0.4386	0.4048		0.4299	0.4165
	0.4468	0.4077		0.4387	0.4197
	0.4373	0.3893		0.4305	0.4019
73	0.4305	0.4019	76	0.4147	0.3814
	0.4387	0.4197		0.4223	0.3990
	0.4474	0.4228		0.4305	0.4019
	0.4386	0.4048		0.4222	0.3840

Table 6d-2. Color bin definition for single 3-step MacAdam ellipse MXAx-PW30-xxxx.

COLOR SPACE	CENTER POINT (cx, cy)	MAJOR AXIS, a	MINOR AXIS, b	ELLIPSE ROTATION ANGLE, θ
7Z	(0.4338, 0.403)	0.00834	0.00408	53.22°

Notes for Tables 6d-1 and 6d-2:

1. Lumileds maintains a tolerance of ± 0.007 on x and y coordinates in the CIE 1931 color space.
2. Tested and binned at 25°C and $I_f=100\text{mA}$.

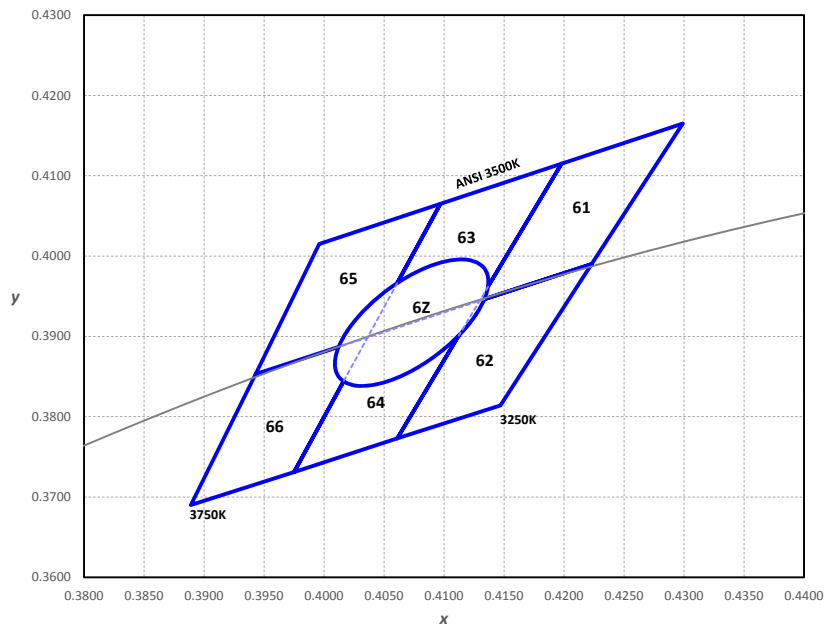

Figure 9e. Color bin structure for LUXEON 3535L Line 3500K.

Table 6e-1. Color bin definitions for LUXEON 3535L Line for MXAx-PW35-xxxx.

BIN	x	y	BIN	x	y
61	0.4130	0.3944	64	0.3975	0.3731
	0.4198	0.4115		0.4036	0.3898
	0.4299	0.4165		0.4130	0.3944
	0.4223	0.3990		0.4061	0.3773
62	0.4061	0.3773	65	0.3943	0.3853
	0.4130	0.3944		0.3996	0.4015
	0.4223	0.3990		0.4097	0.4065
	0.4147	0.3814		0.4036	0.3898
63	0.4036	0.3898	66	0.3889	0.3690
	0.4097	0.4065		0.3943	0.3853
	0.4198	0.4115		0.4036	0.3898
	0.4130	0.3944		0.3975	0.3731

Table 6e-2. Color bin definition for single 3-step MacAdam ellipse MXAx-PW35-xxxx.

COLOR SPACE	CENTER POINT (cx, cy)	MAJOR AXIS, a	MINOR AXIS, b	ELLIPSE ROTATION ANGLE, θ
6Z	(0.4073, 0.3917)	0.00927	0.00414	54.00°

Notes for Tables 6e-1 and 6e-2:

- Lumileds maintains a tolerance of ± 0.007 on x and y coordinates in the CIE 1931 color space.
- Tested and binned at 25°C and $I_f=100\text{mA}$.

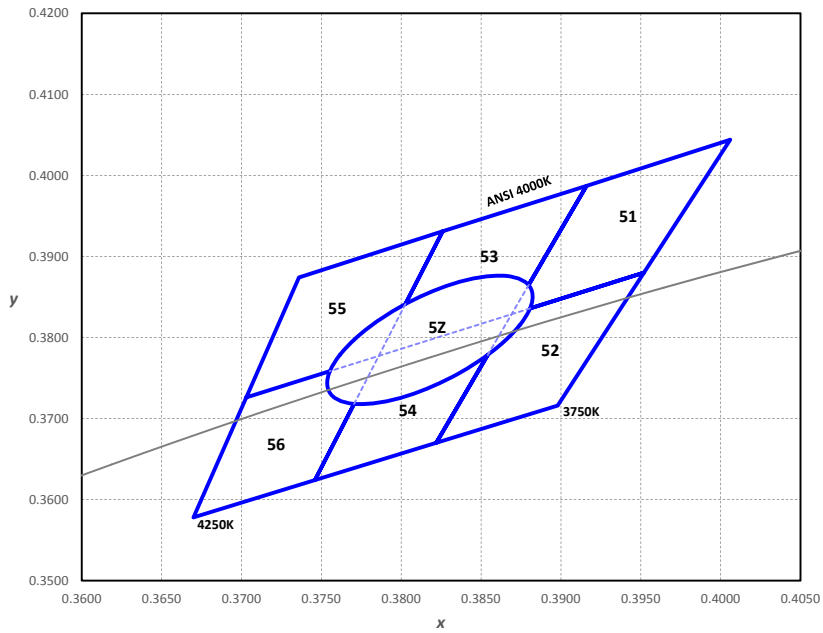

Figure 9f. Color bin structure for LUXEON 3535L Line 4000K.

Table 6f-1. Color bin definitions for LUXEON 3535L Line for MXAx-PW40-xxxx.

BIN	x	y	BIN	x	y
51	0.3869	0.3829	54	0.3746	0.3624
	0.3916	0.3987		0.3786	0.3777
	0.4006	0.4044		0.3869	0.3829
	0.3952	0.3880		0.3822	0.3670
52	0.3822	0.3670	55	0.3703	0.3726
	0.3869	0.3829		0.3736	0.3874
	0.3952	0.3880		0.3826	0.3931
	0.3898	0.3716		0.3786	0.3777
53	0.3786	0.3777	56	0.3670	0.3578
	0.3826	0.3931		0.3703	0.3726
	0.3916	0.3987		0.3786	0.3777
	0.3869	0.3829		0.3746	0.3624

Table 6f-2. Color bin definition for single 3-step MacAdam ellipse MXAx-PW40-xxxx.

COLOR SPACE	CENTER POINT (cx, cy)	MAJOR AXIS, a	MINOR AXIS, b	ELLIPSE ROTATION ANGLE, θ
5Z	(0.3818, 0.3797)	0.00939	0.00402	53.72°

Notes for Tables 6f-1 and 6f-2:

1. Lumileds maintains a tolerance of ± 0.007 on x and y coordinates in the CIE 1931 color space.
2. Tested and binned at 25°C and $I_f=100\text{mA}$.

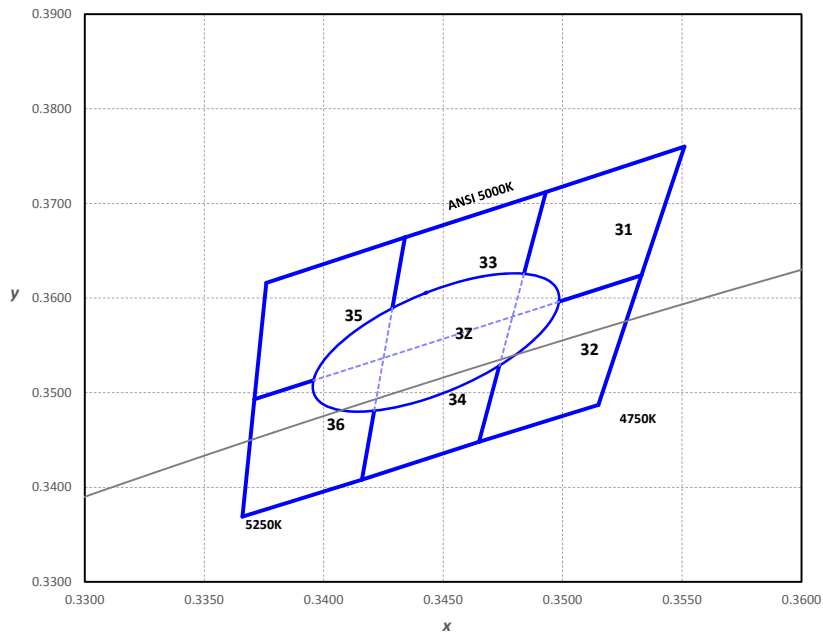

Figure 9g. Color bin structure for LUXEON 3535L Line 5000K.

Table 6g-1. Color bin definitions for LUXEON 3535L Line for MXAx-PW50-xxxx.

BIN	x	y	BIN	x	y
31	0.3479	0.3580	34	0.3416	0.3408
	0.3493	0.3712		0.3425	0.3536
	0.3551	0.3760		0.3479	0.3580
	0.3533	0.3624		0.3465	0.3448
32	0.3465	0.3448	35	0.3371	0.3493
	0.3479	0.3580		0.3376	0.3616
	0.3533	0.3624		0.3434	0.3664
	0.3515	0.3487		0.3425	0.3536
33	0.3425	0.3536	36	0.3366	0.3369
	0.3434	0.3664		0.3371	0.3493
	0.3493	0.3712		0.3425	0.3536
	0.3479	0.3580		0.3416	0.3408

Table 6g-2. Color bin definition for single 3-step MacAdam ellipse MXAx-PW50-xxxx.

COLOR SPACE	CENTER POINT (cx, cy)	MAJOR AXIS, a	MINOR AXIS, b	ELLIPSE ROTATION ANGLE, θ
3Z	(0.3447, 0.3553)	0.00822	0.00354	59.62°

Notes for Tables 6g-1 and 6g-2:

- Lumileds maintains a tolerance of ± 0.007 on x and y coordinates in the CIE 1931 color space.
- Tested and binned at 25°C and $I_f=100\text{mA}$.

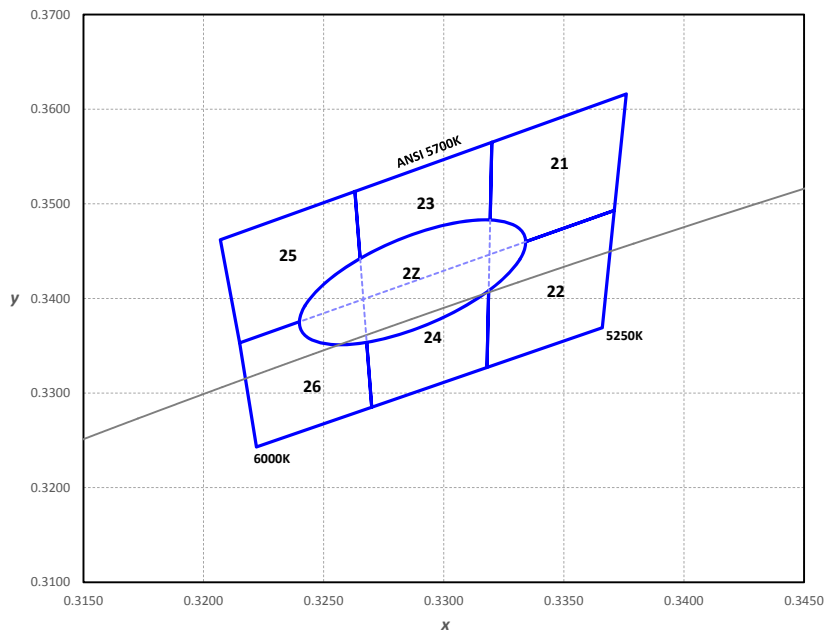

Figure 9h. Color bin structure for LUXEON 3535L Line 5700K.

Table 6h-1. Color bin definitions for LUXEON 3535L Line for MXAx-PW57-xxxx.

BIN	x	y	BIN	x	y
21	0.3319	0.3446	24	0.3270	0.3285
	0.3320	0.3565		0.3267	0.3399
	0.3376	0.3616		0.3319	0.3446
	0.3371	0.3493		0.3318	0.3327
22	0.3318	0.3327	25	0.3215	0.3353
	0.3319	0.3446		0.3207	0.3462
	0.3371	0.3493		0.3263	0.3513
	0.3366	0.3369		0.3267	0.3399
23	0.3267	0.3399	26	0.3222	0.3243
	0.3263	0.3513		0.3215	0.3353
	0.3320	0.3565		0.3267	0.3399
	0.3319	0.3446		0.3270	0.3285

Table 6h-2. Color bin definition for single 3-step MacAdam ellipse MXAx-PW57-xxxx.

COLOR SPACE	CENTER POINT (cx, cy)	MAJOR AXIS, a	MINOR AXIS, b	ELLIPSE ROTATION ANGLE, θ
2Z	(0.3287, 0.3417)	0.00746	0.0032	59.09°

Notes for Tables 6h-1 and 6h-2:

1. Lumileds maintains a tolerance of ± 0.007 on x and y coordinates in the CIE 1931 color space.
2. Tested and binned at 25°C and $I_f=100\text{mA}$.

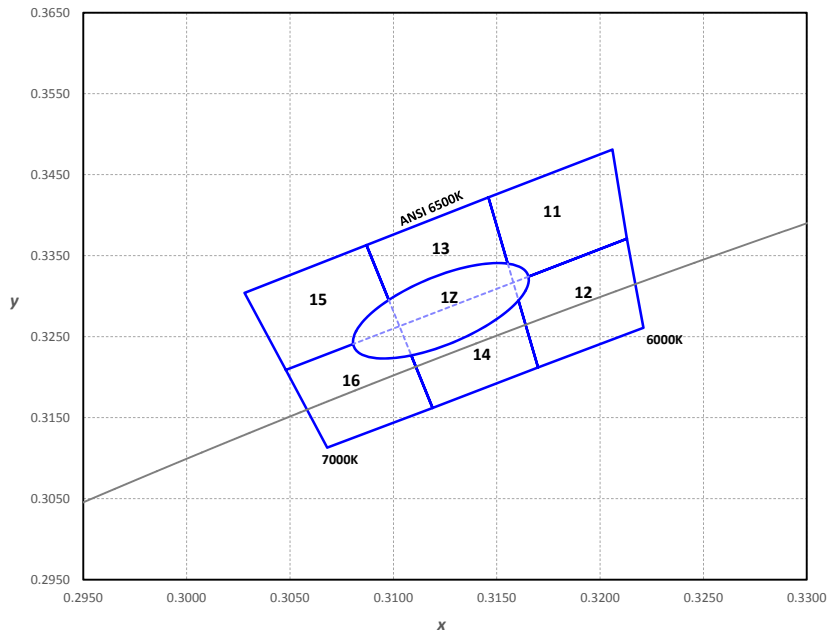

Figure 9i. Color bin structure for LUXEON 3535L Line 6500K.

Table 6i-1. Color bin definitions for LUXEON 3535L Line for MXAx-PW65-xxxx.

BIN	x	y	BIN	x	y
11	0.3158	0.3317	14	0.3119	0.3162
	0.3146	0.3422		0.3103	0.3263
	0.3206	0.3481		0.3158	0.3317
	0.3213	0.3371		0.3170	0.3212
12	0.3170	0.3212	15	0.3048	0.3209
	0.3158	0.3317		0.3028	0.3304
	0.3213	0.3371		0.3087	0.3363
	0.3221	0.3261		0.3103	0.3263
13	0.3103	0.3263	16	0.3068	0.3113
	0.3087	0.3363		0.3048	0.3209
	0.3146	0.3422		0.3103	0.3263
	0.3158	0.3317		0.3119	0.3162

Table 6i-2. Color bin definition for single 3-step MacAdam ellipse MXAx-PW65-xxxx.

COLOR SPACE	CENTER POINT (cx, cy)	MAJOR AXIS, a	MINOR AXIS, b	ELLIPSE ROTATION ANGLE, θ
1Z	(0.3123, 0.3282)	0.00669	0.00285	58.57°

Notes for Tables 6i-1 and 6i-2:

- Lumileds maintains a tolerance of ± 0.007 on x and y coordinates in the CIE 1931 color space.
- Tested and binned at 25°C and $I_f=100\text{mA}$.

Forward Voltage Bins

Table 7. Forward voltage bin definitions for LUXEON 3535L Line.

BIN	FORWARD VOLTAGE ⁽¹⁾ (V _f)	
	MINIMUM	MAXIMUM
S	2.70	2.80
T	2.80	2.90
V	2.90	3.00
W	3.00	3.10
X	3.10	3.20
Y	3.20	3.30

Notes for Table 7:

1. Lumileds maintains a tolerance of ±0.1V on forward voltage measurements.
2. Tested and binned at 25°C and I_f=100mA.

Mechanical Dimensions

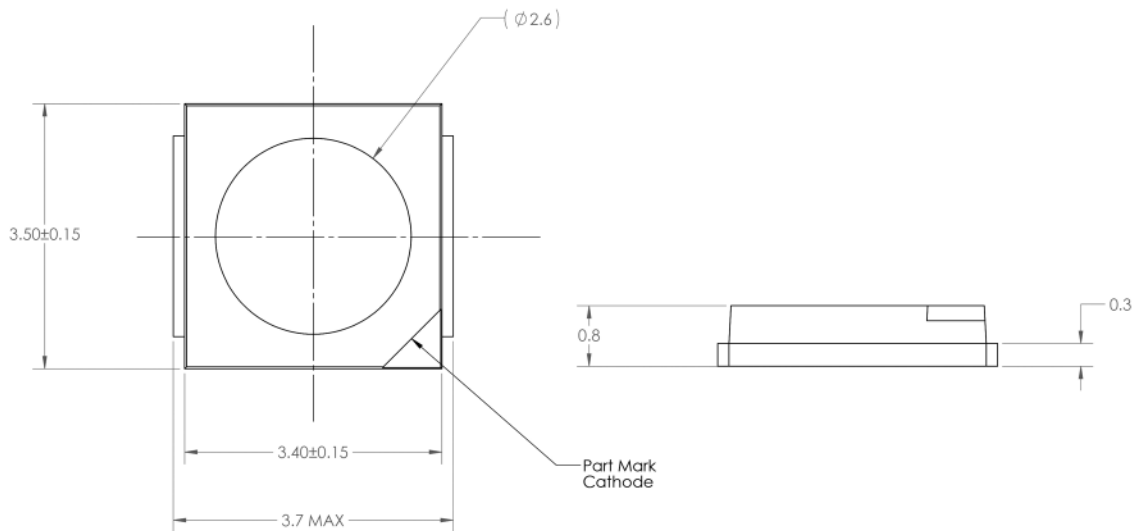

Figure 10. Mechanical dimensions for LUXEON 3535L.

Notes for Figure 10:

1. Drawings are not to scale.
2. All dimensions are in millimeters.

Reflow Soldering Guidelines

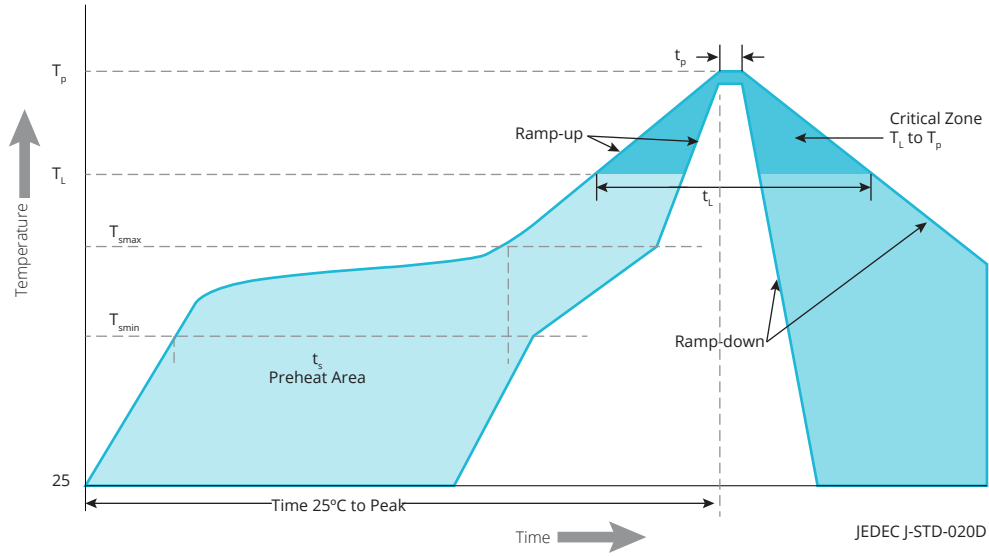

Figure 11. Visualization of the acceptable reflow temperature profile as specified in Table 8.

Table 8. Reflow profile characteristics for LUXEON 3535L Line.

PROFILE FEATURE	LEAD-FREE ASSEMBLY
Preheat Minimum Temperature (T_{smin})	150°C
Preheat Maximum Temperature (T_{smax})	200°C
Preheat Time (t_{smin} to t_{smax})	60 to 120 seconds
Ramp-Up Rate (T_L to T_p)	3°C / second maximum
Liquidus Temperature (T_L)	217°C
Time Maintained Above Temperature T_L (t_t)	60 to 150 seconds
Peak / Classification Temperature (T_p)	260°C
Time Within 5°C of Actual Temperature (t_p)	20 to 40 seconds
Ramp-Down Rate (T_p to T_L)	6°C / second maximum
Time 25°C to Peak Temperature	8 minutes maximum

JEDEC Moisture Sensitivity

Table 9. Moisture sensitivity levels for LUXEON 3535L Line.

LEVEL	FLOOR LIFE		SOAK REQUIREMENTS STANDARD	
	TIME	CONDITIONS	TIME	CONDITIONS
2	1 Year	≤30°C / 60% RH	168 Hours +5 / -0	85°C / 60% RH

Solder Pad Design

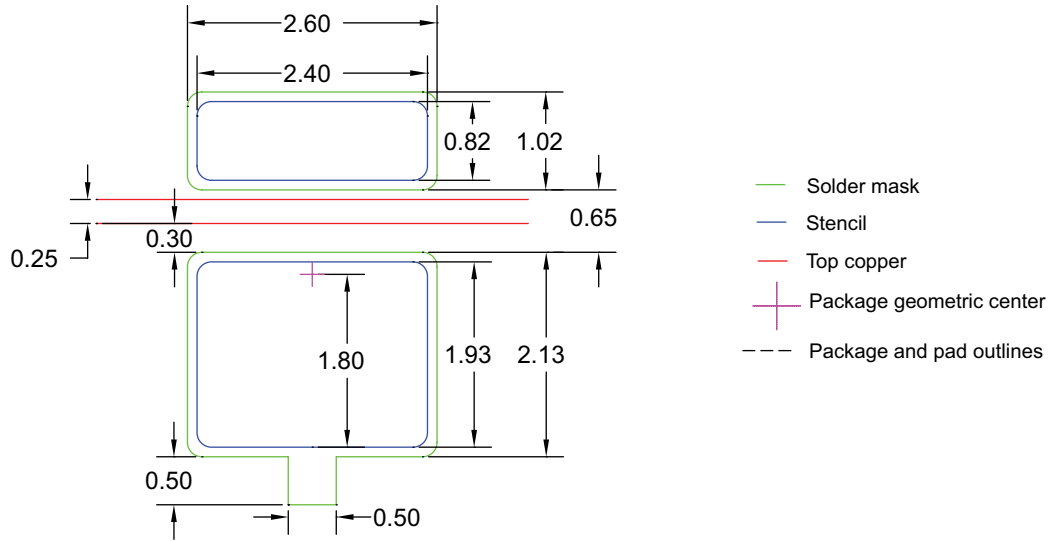

Figure 12. Recommended PCB solder pad layout for LUXEON 3535L Line.

Notes for Figure 12:

1. Drawings are not to scale.
2. All dimensions are in millimeters.

Packaging Information

Pocket Tape Dimensions

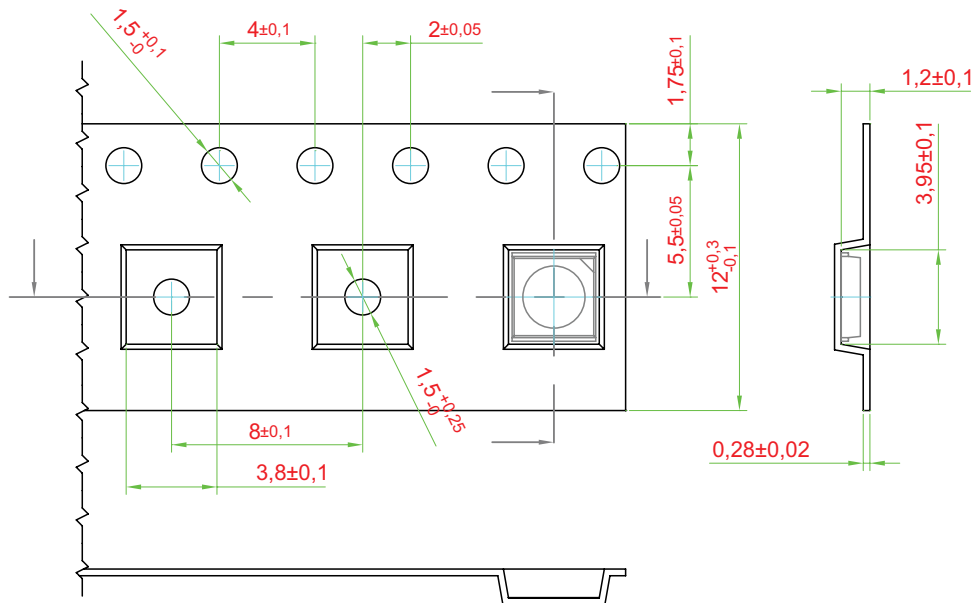

Figure 13. Pocket tape dimensions for LUXEON 3535L Line.

Notes for Figure 13:

1. Drawings are not to scale.
2. All dimensions are in millimeters.

Reel Dimensions

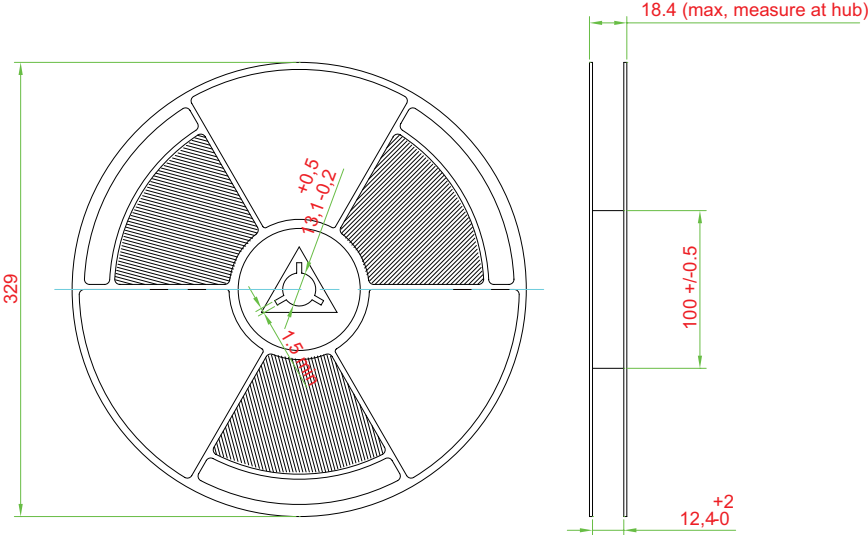

Figure 14. Reel dimensions for LUXEON 3535L Line.

- Notes for Figure 14:
- 1. Drawings are not to scale.
 - 2. All dimensions are in millimeters.

About Lumileds

Lumileds is the global leader in light engine technology. The company develops, manufactures and distributes groundbreaking LEDs and automotive lighting products that shatter the status quo and help customers gain and maintain a competitive edge.

With a rich history of industry “firsts,” Lumileds is uniquely positioned to deliver lighting advancements well into the future by maintaining an unwavering focus on quality, innovation and reliability.

To learn more about our portfolio of light engines, visit lumileds.com.



©2016 Lumileds Holding B.V. All rights reserved.
LUXEON is a registered trademark of the Lumileds Holding B.V.
in the United States and other countries.

lumileds.com

Neither Lumileds Holding B.V. nor its affiliates shall be liable for any kind of loss of data or any other damages, direct, indirect or consequential, resulting from the use of the provided information and data. Although Lumileds Holding B.V. and/or its affiliates have attempted to provide the most accurate information and data, the materials and services information and data are provided “as is,” and neither Lumileds Holding B.V. nor its affiliates warrants or guarantees the contents and correctness of the provided information and data. Lumileds Holding B.V. and its affiliates reserve the right to make changes without notice. You as user agree to this disclaimer and user agreement with the download or use of the provided materials, information and data.