

PRODUCT NUMBER SEE SHEET 2

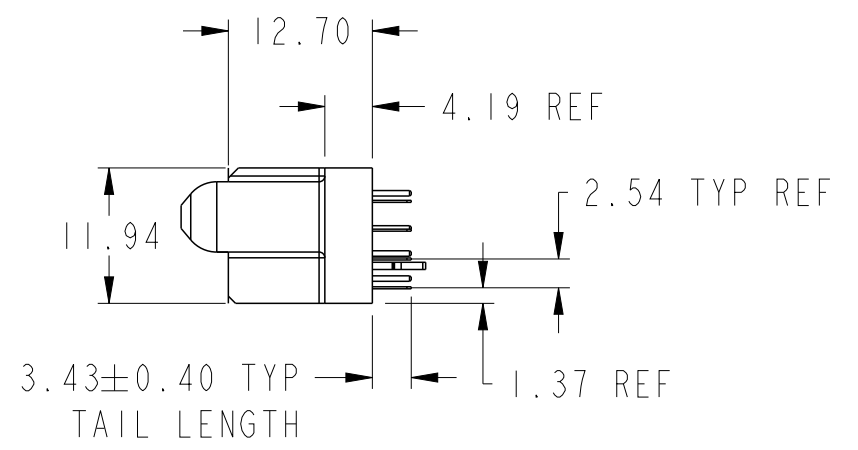
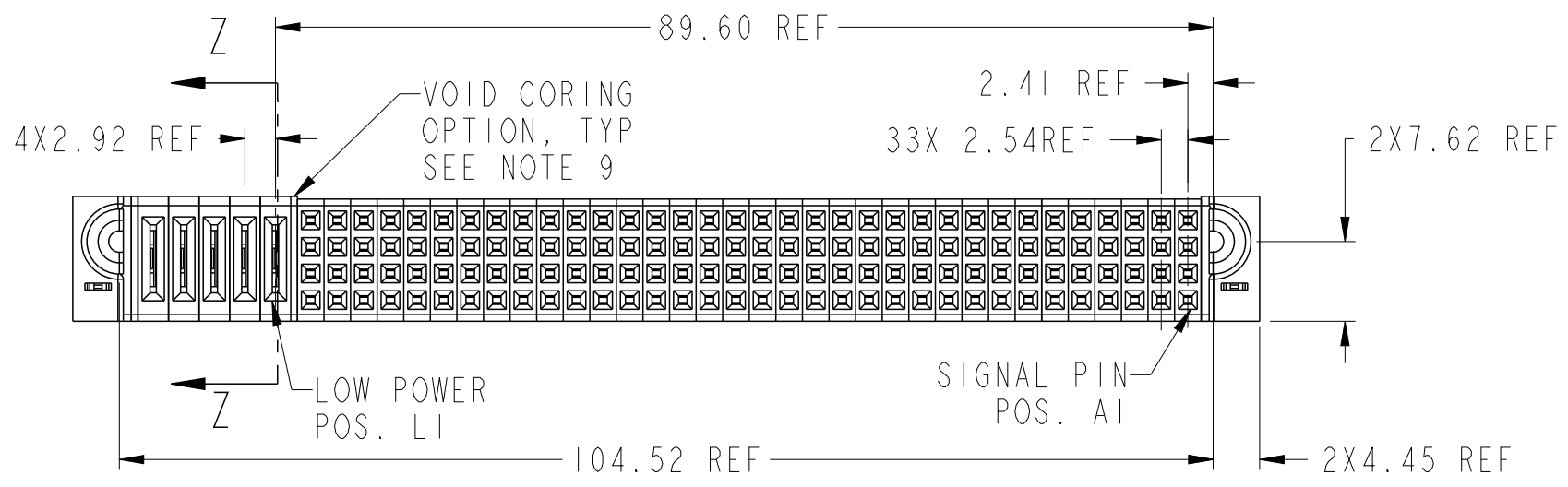
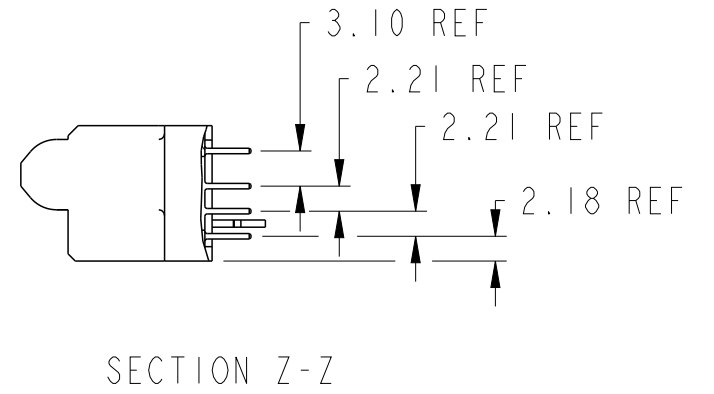
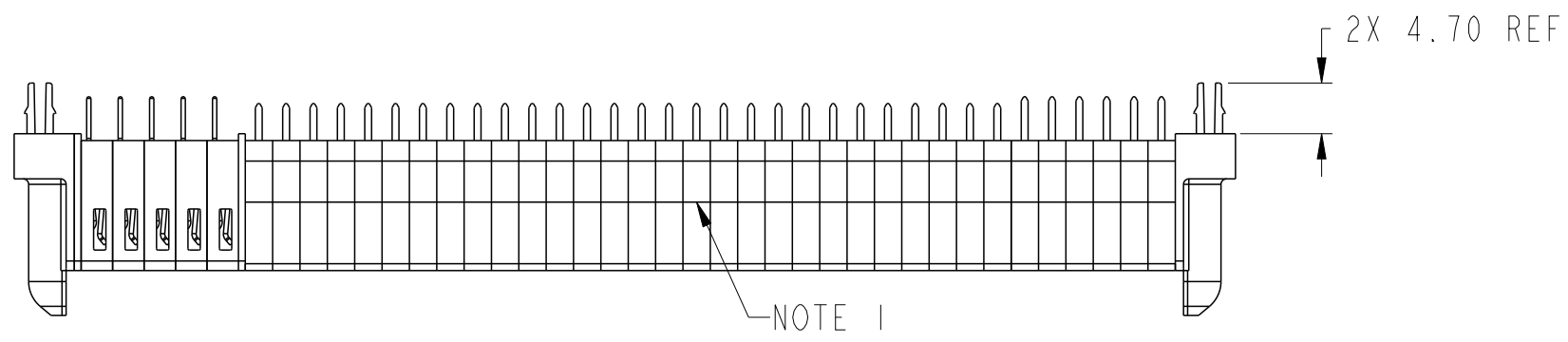
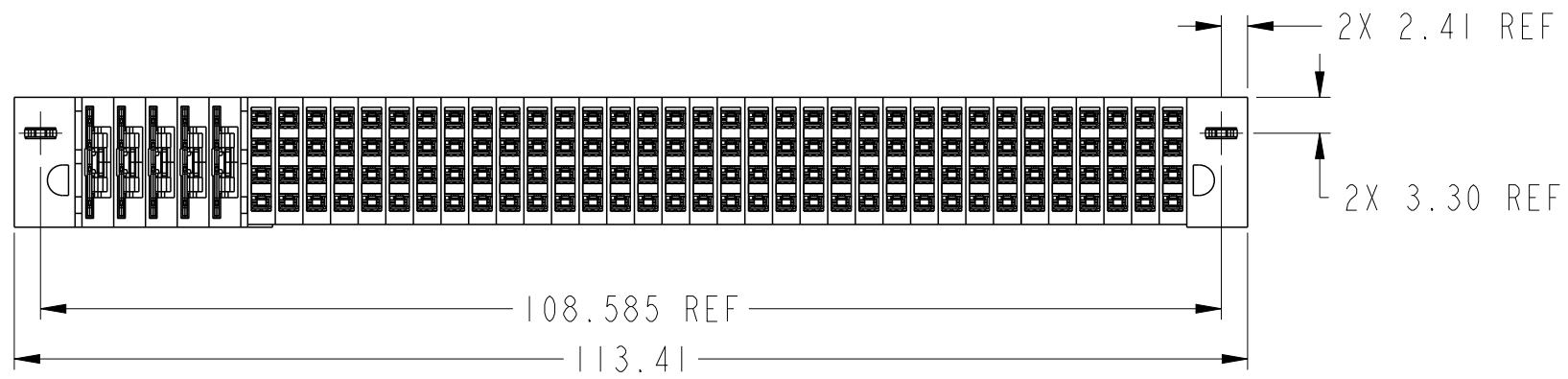

Copyright FCI.

spec ref		dr	Eddy Zeng	2013/11/10	projection	MM	size	A3	scale	3:2		
tolerance std ASME Y14.5		eng	Xie Bob	2013/11/15			ecn no	-				
TOLERANCES UNLESS OTHERWISE SPECIFIED		chr	Li-He	2013/11/15	product family	PowerBlade+	rel level		Released			
		appr	Pei-Ming Zheng	2013/11/15			rev		A			
surface	✓	linear	0.X	±0.50	title		136S + 5LP		dwg no		10106268-0534001	
			0.XX	±0.25	www.fci.com		cat. no.		Product - Customer Drw		sheet 1 of 3	
			0.XXX	±0.10								
		angular	0°	±2°								

1

2

3

4

A

A

NOTES:

- 1) "FCI", PART NUMBER AND DATE CODE TO BE MARKED ON THIS SURFACE.
THE MARK CAN BE OMITTED IF THERE IS NOT ENOUGH SPACE ON THIS SURFACE.
- 2) MATERIALS:
-HOUSING - GLASS FILLED WITH HIGH TEMP THERMOPLASTIC, UL94V-0.
-SIGNAL CONTACT - COPPER ALLOY.
-POWER CONTACT - HIGH CONDUCTIVITY COPPER ALLOY.
- 3) PLATING SPECIFICATION REFER TO FCI 10116351
- 4) DENOTES CONNECTOR KEEP OUT ZONE.
- 5) DATUM AND BASIC DIMENIONS WERE ESTABLISHED BY CUSTOMER.
- 6) ALL HOLE DIAMETERS ARE FINISHED HOLE SIZES.
- 7) 1.15 ± 0.025MM DRILLED HOLE PLATED WITH 0.00762MM MIN Sn
OVER 0.0254-0.0762MM Cu PLATING TO ACHIEVE A 1.02 ± 0.07MM HOLE.
- 8) PRODUCT SPECIFICATION REFER TO FCI GS-12-658.
APPLICATION SPECIFICATION REFER TO FCI GS-20-141.
PRODUCT PACKAGED IN TRAYS, REFER TO FCI GS-14-1502.
- 9) THE VOID CORING IN BETWEEN POWER MODULES, SIGNAL
MODULES AND END MODULES ARE OPTIONAL AND THE SHAPE
MAY BE DIFFERENT FOR OPTIMIZE THE MOLDING PROCESS. THE
VOID CORING WILL NOT EFFECT TO PRODUCT FUNCTION.

B

B

C



C

D

D

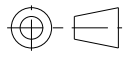
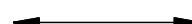

Copyright FCI.

dr	Eddy Zeng	2013/11/10	projection 	MM 	size	A3	scale	1:1
eng	Xie Bob	2013/11/15			ecn no	-		
chr	Li-He	2013/11/15			rel level	Released		
appr	Pei-Ming Zheng	2013/11/15			product family	PowerBlade+		
		title 136S + 5LP VT STB RECEPTACLE		dwg no 10106268-0534001	rev A			
www.fci.com		cat. no.	Product - Customer Drw		sheet 3 of 3			

2

3