



Part Number: D4C1720

Electrical Specifications

Frequency Range (GHz):	17.0 – 20.0
Isolation (dB):	22 MIN (per junction)
Insertion Loss (dB):	0.4 MAX (per junction)
VSWR:	1.2:1 MIN
Forward Power (W):	10 AVG 50 PK

Mechanical/Environmental Specifications

Connector Type:	SMA
Connector Body:	Passivated stainless steel
Connector Pin:	Gold plated copper
Load Body:	Brass
Magnetic Shunt:	Nickel plated CRS
Operational Temp:	-20°C to +65°C
Weight (oz)	2.0 MAX

D4C1720 Dimensions

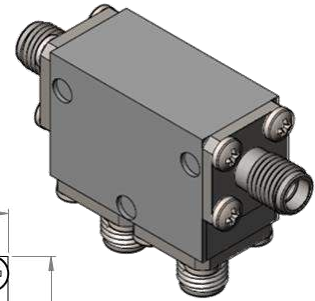
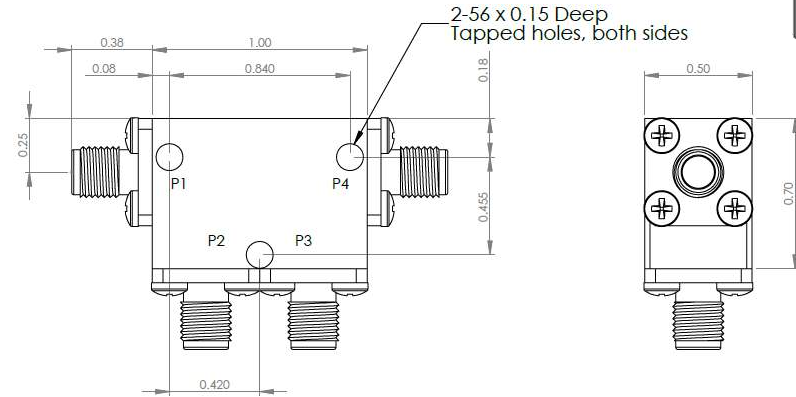

D4C1720-3 Dimensions

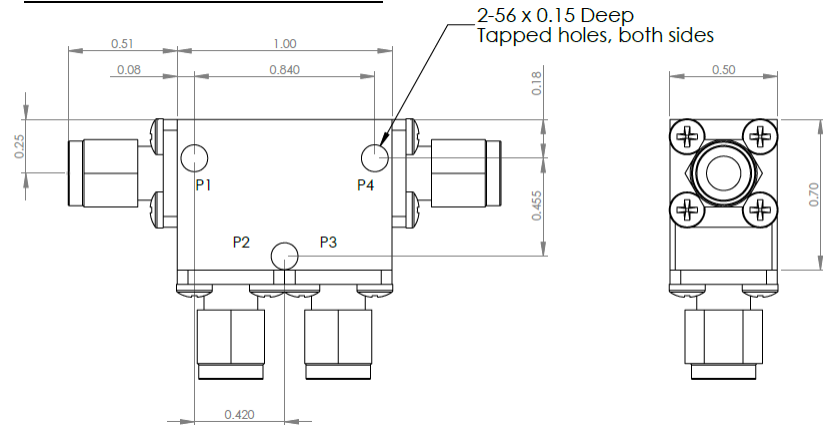

Dimensions are in inches
Tolerance

XX	±0.03
XXX	±0.010

Type of Device	PN Suffix	Connector Configuration Input / Output	PN Example
Dual Junction Circulator 4-Port Device Port 1 / Port 2 / Port 3 / Port 4	No Dash	Female / Female / Female / Female	D4C1720
	-1	Male / Female / Female / Female	D4C1720-1
	-2	Female / Male / Female / Female	D4C1720-2
	-3	Male / Male / Male / Male	D4C1720-3
	-4	Female / Female / Male / Female	D4C1720-4
	-5	Female / Female / Female / Male	D4C1720-5



MEASURED DATA

Part Number: D4C1720, P4→P1, P2 & P3 Terminated with 50Ω, +25°C

