

Description

- 3.2 x 1.5mm SMD crystal in a ceramic package with a seam sealed metal lid, hermetically sealed.
- Model CFPX-217
- Model Issue number 6

Frequency Parameters

- Frequency 32.7680kHz
- Frequency Tolerance $\pm 20.00\text{ppm}$
- Tolerance Condition @ 25°C $\pm 5^\circ\text{C}$
- Overtone Order Fundamental
- Ageing $\pm 3\text{ppm}$ max in 1st year @ 25°C

Electrical Parameters

- Load Capacitance (CL) 7.00pF
- Shunt Capacitance (C0) 1.0pF typical
- Drive Level 1.0 μW max
- ESR 70.00k Ω max

Environmental Parameters

- Storage Temperature Range: -55 to 125°C
- Drop: 100g dummy, 150cm drop (3 directions x 10 times) onto concrete
- Vibration: 1.5mm amplitude, 10Hz-60Hz with cycle time 2-3 minutes in 3 directions (X, Y and Z axis) each for 2 hours
*Measure after 2 hours left at room temperature

Manufacturing Details

- RoHS Terminations NiAu
- RoHS Reflow Temp 260°C max for 10s max

Compliance

- RoHS Status (2015/863/EU) Compliant
- REACH Status Compliant
- MSL Rating (JDEC-STD-033): Not Applicable

Packaging Details

- Tape & reel in accordance with EIA-481
Quantities below the standard reel size to be supplied on cut tape.
Standard Quantity: 3,000 Pieces

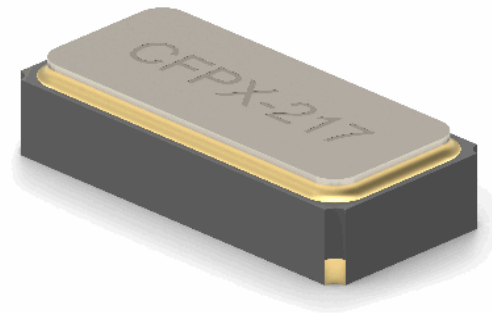

Outline (mm)

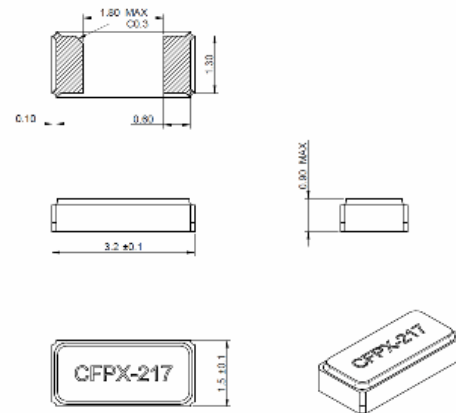

Recommended Solder Pad Layout

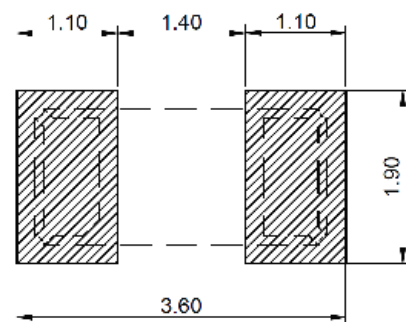

Sales Office Contact Details:

UK: +44 (0)1460 270200

USA: +1.760 668 8935

Email: info@iqdfrequencyproducts.com

Web: www.iqdfrequencyproducts.com

Typical Frequency Stability Characteristics

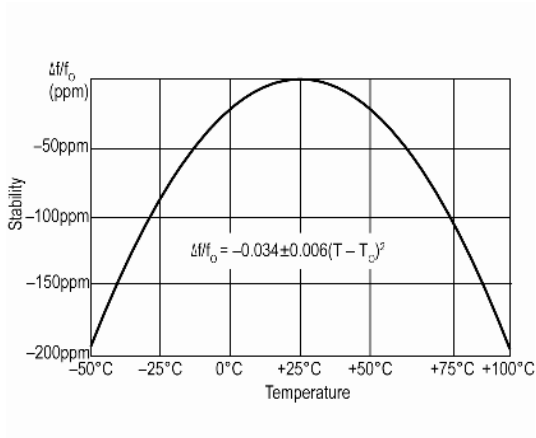

Sales Office Contact Details:

UK: +44 (0)1460 270200

USA: +1.760 668 8935

Email: info@iqdfrequencyproducts.com

Web: www.iqdfrequencyproducts.com