

NOTES:

- 1. MATERIAL: 0.008" TIN PLATED STEEL PER ASTM A623/A624
- 2. PARTS PER REEL: 120

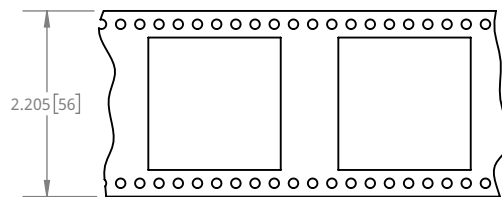
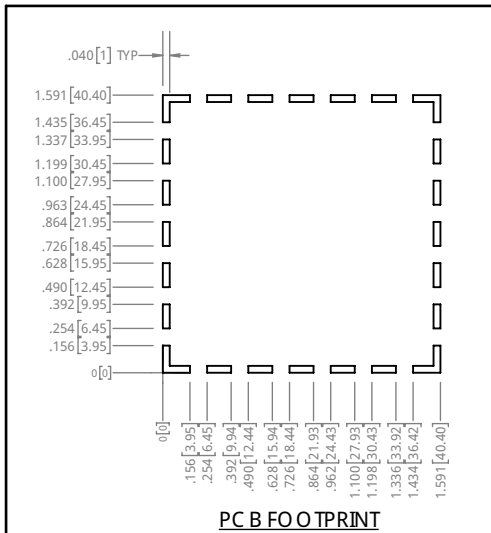
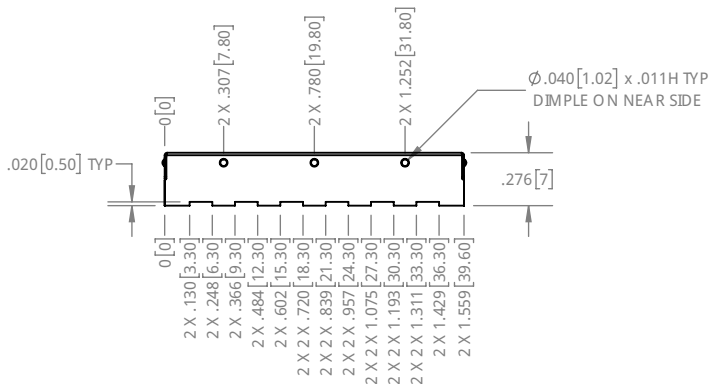
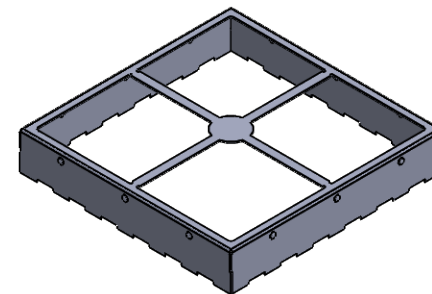
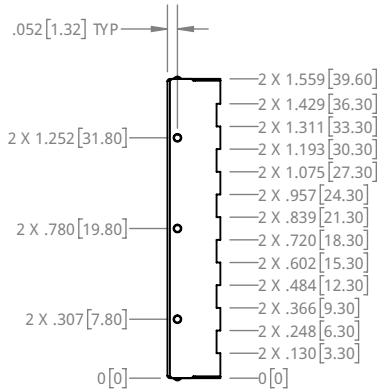
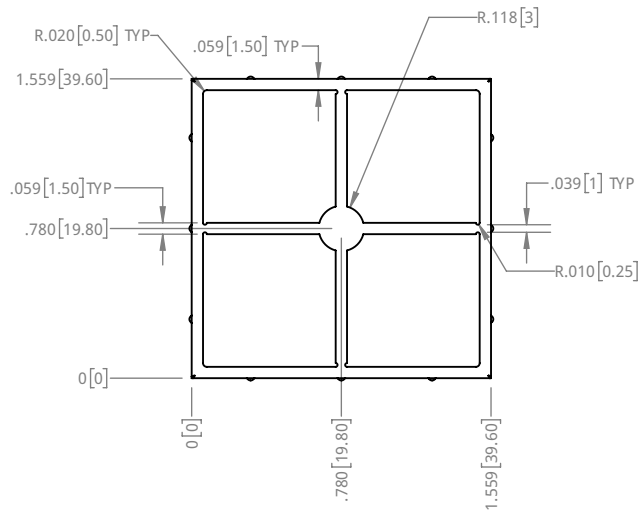

TAPE AND REEL

QE 13025

UNLESS OTHERWISE SPECIFIED
U/M INCHES TOLERANCE ±0.005

DATE 18-05-03



PART NUMBER PIC-S-208F	REV. 0
DESCRIPTION SHIELD FRAME	
SCALE 1:1	SHEET 1 OF 1

PROPRIETARY NOTICE: THESE DRAWINGS, LISTS OR SPECIFICATIONS ARE THE CONFIDENTIAL INFORMATION AND/OR TRADE SECRETS OF 3G SHIELDING SPECIALTIES, P., AND ARE TO REMAIN THE CONFIDENCE OF THE BUYER. ANY REPRODUCTION OR TRANSMISSION OF THESE DRAWINGS, LISTS OR SPECIFICATIONS SHALL NOT BE REPRODUCED, REPRODUCED, USED FOR THE PHYSICAL MANUFACTURE OR SALE OF EQUIPMENT OR USED FOR ANY OTHER PURPOSE OTHER THAN EVALUATION.

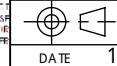

ROHS COMPLIANCE 2011/65/EU