

TUNING FORK CRYSTAL UNIT (SMD · Ceramic Package)

RoHS compliant / Pb free

CM1610H

5,000pcs/reel

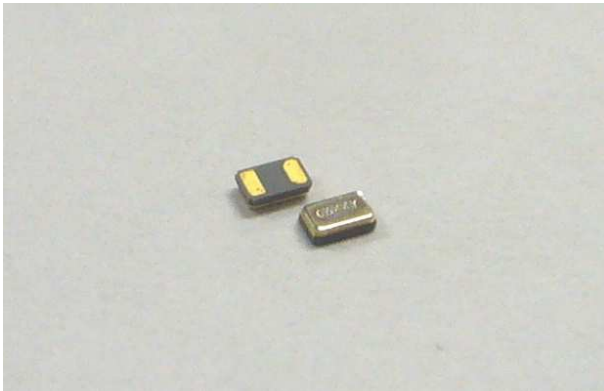

FEATURES

- Ultra-lightweight microminiature TF Crystal units SMD type
- Frequency range : 32.768kHz
- External dimensions (mm)
L : 1.6 x W : 1.0 x H : 0.5
- Applications
Small communication devices

DIMENSION [mm]

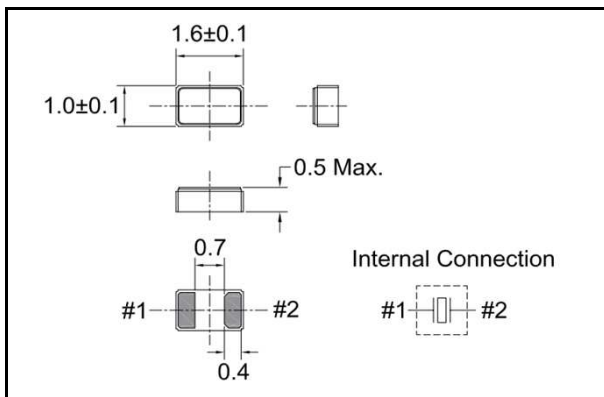

SOLDER PAD LAYOUT [mm]

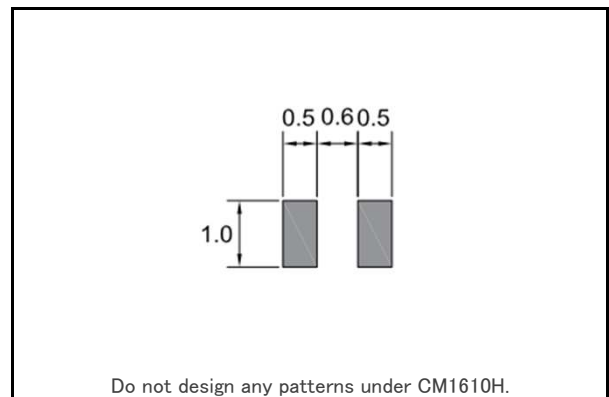

STANDARD SPECIFICATIONS

Item	Model	CM1610H	Conditions
Nominal Frequency	f_0	32.768kHz	
Frequency Tolerance	$\Delta f/f_0$	± 20 ppm	at 25°C
Load capacitance	C_L	6.0pF / 7.0pF / 9.0pF / 12.5pF	Please specify your requirement
Operating Temperature Range	T_{OPR}	-40°C ~ +85°C	
Storage Temperature Range	T_{STR}	-55°C ~ +125°C	
Turnover Temperature	T_M	25°C ± 5°C	
Temperature Coefficient	β	(-0.036 ± 10%) ppm/°C ²	
Motional (series) resistance	R_1	90K Ω Max.	at 25°C
Level of drive	D_L	0.5 μW Max.	
Aging (first year)	$\Delta f/f_0$	± 3 ppm Max.	25°C ± 3°C
Shunt capacitance	C_0	1.2pF Typ.	

■ PART NUMBERING SYSTEM

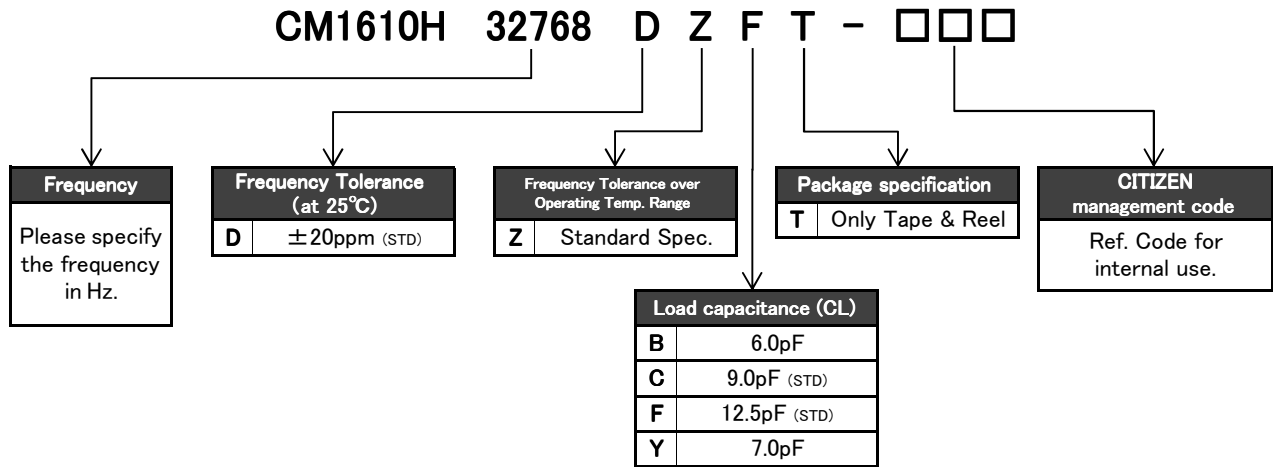

*Please contact us for specifications available.

■ Part Marking [standard]



- C : Manufacture's ID Code
- y : The last digit of production year
- w : Production week code
- * : CL Code
 - B: 6.0pF
 - C: 9.0pF
 - F: 12.5pF
 - Y: 7.0pF

■ Reflow profile

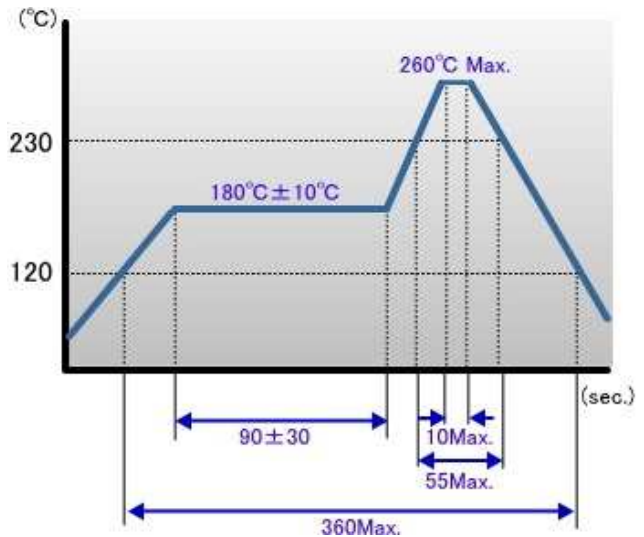

■ Packing

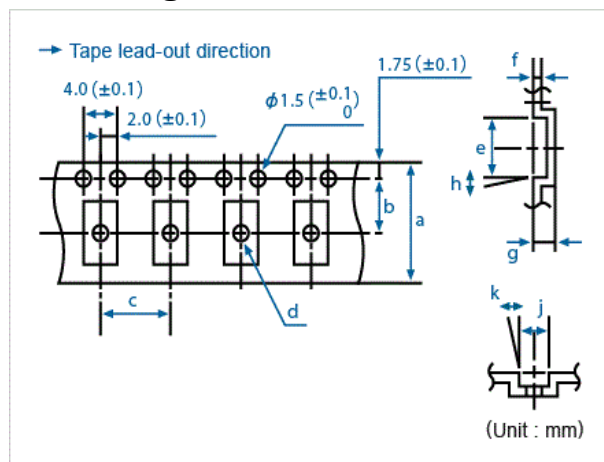

Conforming to JIS C 0806 TB1208NEIAJ and RC-1009B TE1208N

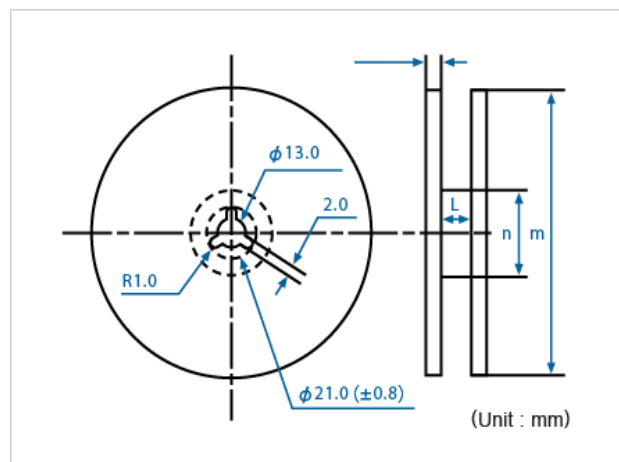

Conforming to JIS C 0806 R12R and EIAJ RC-1009B R15

Q'ty/reel	a	b	c	d (φ)	e	f	g	h	j	k	l	m (φ)	n (φ)
5,000	8.0	3.5	4.0	0.5	1.8	0.23	0.6	5°	1.2	5°	9.0	180	60

Product specifications are subject to change without notice.

Rev.2