

吸着カバー無し図 (参考)
WITHOUT METAL COVER
(REFERENCE)

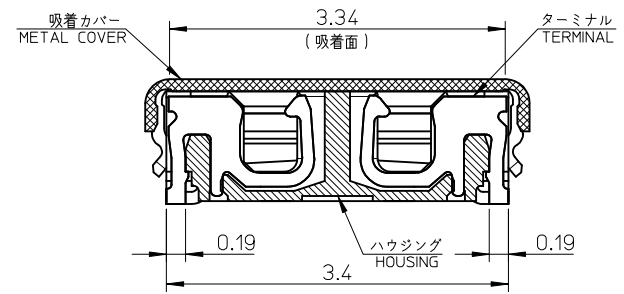

SECTION X-X

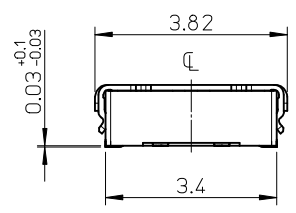
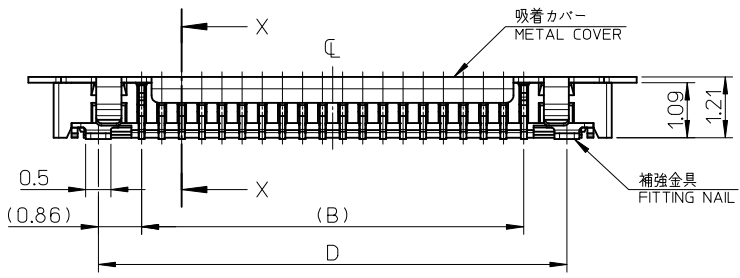
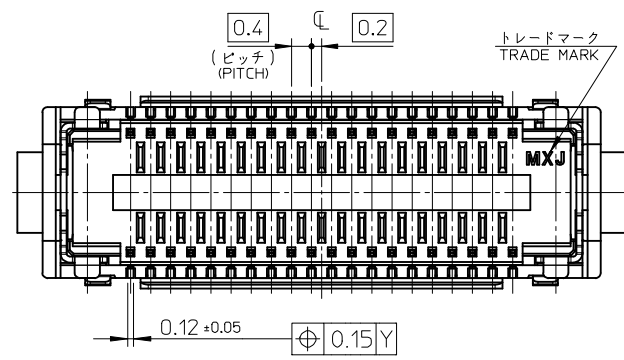

11.32	14.1	9.6	13.1	501527-0530	501527-0539	50
9.32	12.1	7.6	11.1	501527-0430	501527-0439	40
7.72	10.5	6.0	9.5	501527-3230	501527-3239	32
7.32	10.1	5.6	9.1	501527-0330	501527-0339	30
5.32	8.1	3.6	7.1	501527-0230	501527-0239	20
D	C	B	A	EMBOSSED TAPE PKG.	MATERIAL No.	CKT.
				ORDER No. オーダー番号	MODEL No. : 501527-**39	

REVISED EC NO. J2017-0224 DRW: NISHIKAWA 2016/10/12 CHK: KATAHASHI 2016/10/12 APPR: MSASAO 2016/10/14	GENERAL TOLERANCES (UNLESS SPECIFIED)		DIMENSION STYLE MM ONLY		SCALE 10:1	DESIGN UNITS METRIC	THIRD ANGLE PROJECTION
	0.25 UNDER	±	DRAWN BY	DATE	TITLE		
	0.25 OVER 0.5 UNDER	±	RTAKEUCHI	2005/10/25	0.4 B-TO-B CONN. HGT=1.3 REC ASSY WITH COVER -LEAD FREE-		
	0.5 OVER 1.0 UNDER	±	CHECKED BY	DATE	molex DOCUMENT NO. SD-501527-001 SHEET NO. 1 OF 2		
	0 OVER 10 UNDER	± 0.2	THIRATA	2005/10/25			
10 OVER 30 UNDER	± 0.25	APPROVED BY	DATE	THIS DRAWING CONTAINS INFORMATION THAT IS PROPRIETARY TO MOLEX ELECTRONIC TECHNOLOGIES, LLC AND SHOULD NOT BE USED WITHOUT WRITTEN PERMISSION			
30 OVER	± 0.3	MSASAO	2005/10/25				
ANGULAR ±3 °		MATERIAL NO.		SEE CHART			
DRAFT WHERE APPLICABLE MUST REMAIN WITHIN DIMENSIONS		SIZE					
		A3					

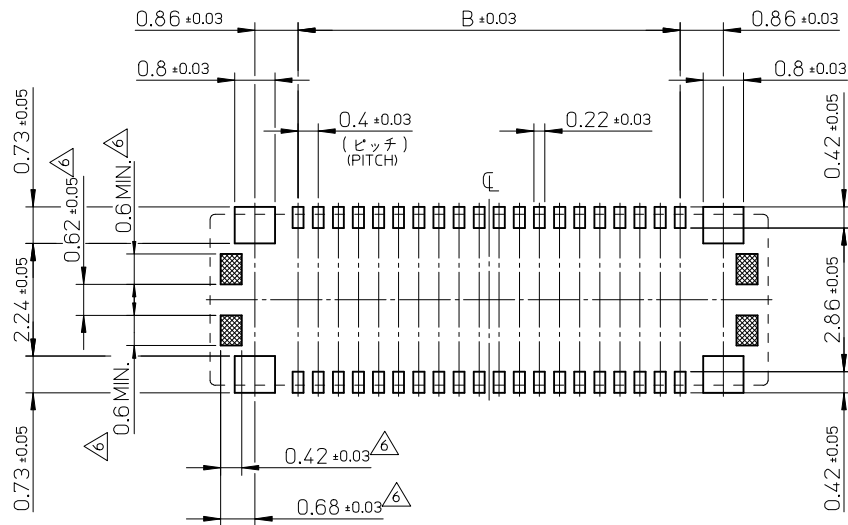

参考基板レイアウト (マウント面)
P.C.BOARD PATTERN DIMENSION. (REFERENCE)
(MOUNTING AREA)

注記 NOTES

1. 使用材料 MATERIAL

ハウジング: 液晶ポリマー (LCP) ガラス充填 UL94V-0 (黒)
HOUSING: LIQUID CRYSTAL POLYMER (GLASS FILLED) UL94V-0 (COLOR: BLACK)

ターミナル: りん青銅 (t=0.12)
TERMINAL: PHOSPHOR BRONZE (t=0.12)

金具: コルソン銅 (t=0.12)
FITTING NAIL: CORSON TYPE COPPER ALLOY (t=0.12)

吸着カバー: ステンレス (t=0.12)
METAL COVER: STAINLESS (t=0.12)

2. メッキ仕様 PLATING

ターミナル TERMINAL

金メッキ 0.2 マイクロメートル以上 (コンタクト部)
GOLD 0.2MICROMETER MINIMUM (CONTACT AREA)

金メッキ 0.4 マイクロメートル以下 (テール部)
GOLD 0.4MICROMETER MAXIMUM (TAIL AREA)

下地メッキ: ニッケルメッキ 1.5 マイクロメートル以上
UNDER PLATING: NICKEL 1.5MICROMETER MINIMUM

※コンタクト部とテール部はニッケルメッキによって分断されている金メッキです。
DIVIDE INTO PARTS THE GOLD PLATING OF THE CONTACT AND THE TAIL PART BY THE NICKEL PLATING.

金具 FITTING NAIL

半田付け処理 (金・パラジウムコート)
SOLDERABILITY IMPROVEMENT COAT (Au & Pd COAT)

下地メッキ: ニッケルメッキ 1.0 マイクロメートル以上
UNDER PLATING: NICKEL 1.0MICROMETER MINIMUM

△3 (全極数 / 2) = 偶数の場合に適用。
APPLY FOR (CIRCUIT / 2) = EVEN.

4. 嵌合相手: 501531 シリーズ
MATE WITH: 501531 SERIES.

5. テール平坦度は、0.08 以下
テール及び金具の平坦度は、0.1 以下
TAIL COPLANARITY TO BE 0.08 MAXIMUM.
TAIL AND FITTING NAIL COPLANARITY TO BE 0.1 MAXIMUM.

△6 斜線部はパターン書き込み禁止範囲と半田禁止範囲を示す。
ただし、斜線部に補強金具と同一配線を配置する場合はレジストを施し、この部分に半田は無きこと。
NO PATTERN CIRCUIT AND NO SOLDER ALLOWED IN THE SHADED AREA.
HOWEVER, IF NEEDED, TO ADD A TRACE OF THE SAME CIRCUIT, PUT THE SOLDER-RESIST.
YET NO SOLDER ALLOWED IN THE AREA.

7. ELV and RoHS COMPLIANT.

REVISED EC NO: J2017-0224 DRWN: MISHIKAWA 2016/10/12 CHKD: TAKAHASHI 2016/10/12 APPR: MSASAO 2016/10/14	GENERAL TOLERANCES (UNLESS SPECIFIED)		DIMENSION STYLE MM ONLY		SCALE 10:1	DESIGN UNITS METRIC	THIRD ANGLE PROJECTION	
	0.25 UNDER	±	DRAWN BY RTAKEUCHI	DATE 2005/10/25	TITLE 0.4 B-TO-B CONN. HGT=1.3 REC ASSY WITH COVER -LEAD FREE-			
	0.25 OVER	0.5 UNDER	±	CHECKED BY THIRATA	DATE 2005/10/25	molex		
	0.5 OVER	1.0 UNDER	±	APPROVED BY MSASAO	DATE 2005/10/25			
	0 OVER	10 UNDER	±0.2	MATERIAL NO.		DOCUMENT NO.	SHEET NO.	
	10 OVER	30 UNDER	±0.25	SEE SHEET1		SD-501527-001	2 OF 2	
	30 OVER	±0.3	DRAFT WHERE APPLICABLE MUST REMAIN WITHIN DIMENSIONS		THIS DRAWING CONTAINS INFORMATION THAT IS PROPRIETARY TO MOLEX ELECTRONIC TECHNOLOGIES, LLC AND SHOULD NOT BE USED WITHOUT WRITTEN PERMISSION			
	ANGULAR	±3 °	SIZE A3					

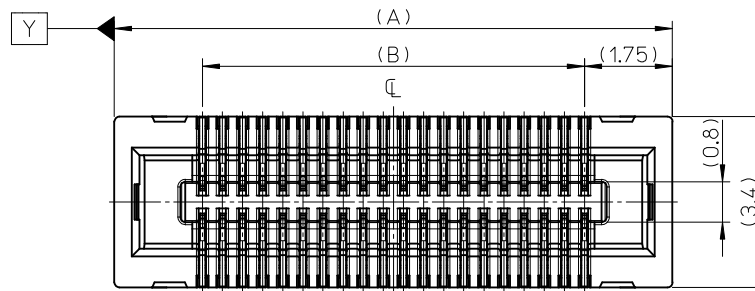
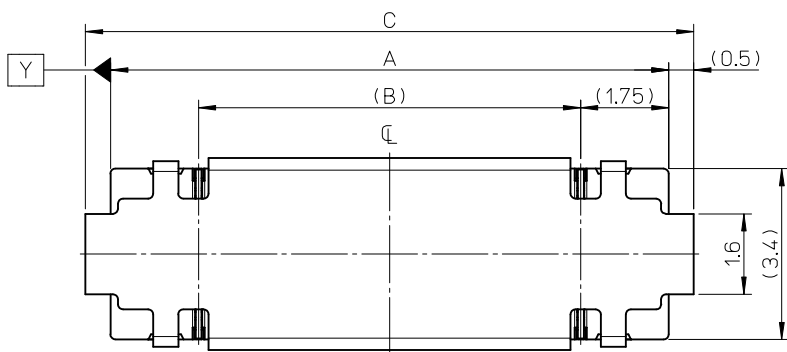

吸着カバー無し図 (参考)
WITHOUT METAL COVER
(REFERENCE)

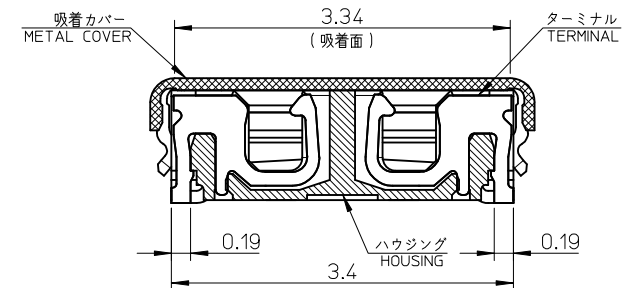
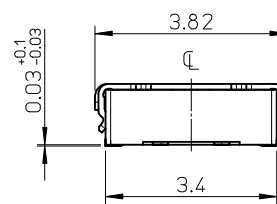
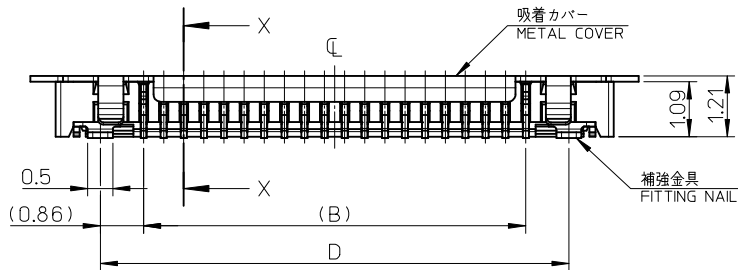

SECTION X-X

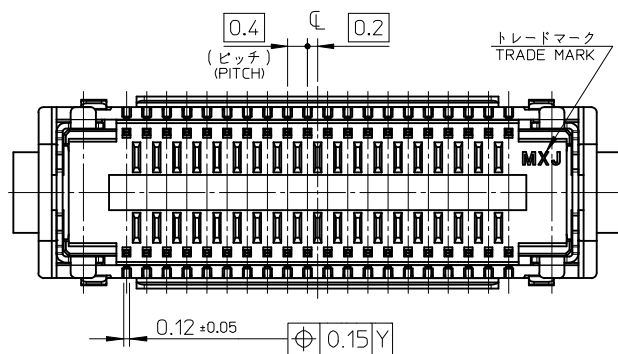

11.32	14.1	9.6	13.1	501527-0530	501527-0539	50
9.32	12.1	7.6	11.1	501527-0430	501527-0439	40
7.72	10.5	6.0	9.5	501527-3230	501527-3239	32
7.32	10.1	5.6	9.1	501527-0330	501527-0339	30
5.32	8.1	3.6	7.1	501527-0230	501527-0239	20
D	C	B	A	EMBOSSED TAPE PKG.	MATERIAL No.	CKT.
				ORDER No. オーダー番号	MODEL No. : 501527-**39	

REVISED EC NO. J2017-0224 G DRM: NISHIKAWA 2016/10/12 CHKD: TAKAHASHI 2016/10/12 APPR: MSASAO 2016/10/14	GENERAL TOLERANCES (UNLESS SPECIFIED)		DIMENSION STYLE MM ONLY		SCALE 10:1	DESIGN UNITS METRIC	THIRD ANGLE PROJECTION
	0.25 UNDER	±	DRAWN BY RTAKEUCHI	DATE 2005/10/25	TITLE 0.4 B-TO-B CONN. HGT=1.3 REC ASSY WITH COVER -LEAD FREE-		
	0.25 OVER 0.5 UNDER	±	CHECKED BY THIRATA	DATE 2005/10/25			
	0.5 OVER 1.0 UNDER	±	APPROVED BY MSASAO	DATE 2005/10/25			
0 OVER 10 UNDER	± 0.2	MATERIAL NO.		DOCUMENT NO.	SHEET NO.		
10 OVER 30 UNDER	± 0.25	SEE CHART		SD-501527-001	1 OF 2		
30 OVER	± 0.3	DRAFT WHERE APPLICABLE MUST REMAIN WITHIN DIMENSIONS		THIS DRAWING CONTAINS INFORMATION THAT IS PROPRIETARY TO MOLEX ELECTRONIC TECHNOLOGIES, LLC AND SHOULD NOT BE USED WITHOUT WRITTEN PERMISSION			

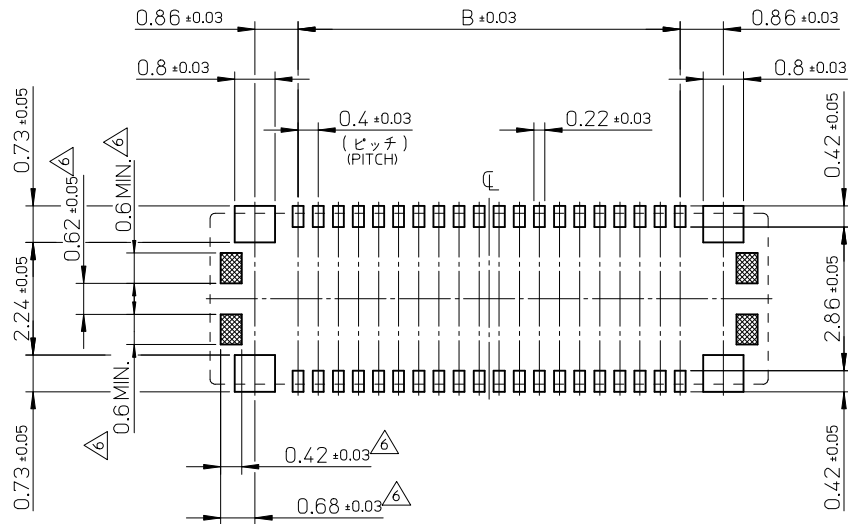

参考基板レイアウト (マウント面)
P.C.BOARD PATTERN DIMENSION. (REFERENCE)
(MOUNTING AREA)

注記 NOTES

1. 使用材料 MATERIAL

ハウジング: 液晶ポリマー (LCP) ガラス充填 UL94V-0 (黒)
HOUSING: LIQUID CRYSTAL POLYMER (GLASS FILLED) UL94V-0 (COLOR: BLACK)

ターミナル: りん青銅 (t=0.12)
TERMINAL: PHOSPHOR BRONZE (t=0.12)

金具: コルソン銅 (t=0.12)
FITTING NAIL: CORSON TYPE COPPER ALLOY (t=0.12)

吸着カバー: ステンレス (t=0.12)
METAL COVER: STAINLESS (t=0.12)

2. メッキ仕様 PLATING

ターミナル TERMINAL

金メッキ 0.2 マイクロメートル以上 (コンタクト部)
GOLD 0.2MICROMETER MINIMUM (CONTACT AREA)

金メッキ 0.4 マイクロメートル以下 (テール部)
GOLD 0.4MICROMETER MAXIMUM (TAIL AREA)

下地メッキ: ニッケルメッキ 1.5 マイクロメートル以上
UNDER PLATING: NICKEL 1.5MICROMETER MINIMUM

※コンタクト部とテール部はニッケルメッキによって分断されている金メッキです。
DIVIDE INTO PARTS THE GOLD PLATING OF THE CONTACT AND THE TAIL PART BY THE NICKEL PLATING.

金具 FITTING NAIL

半田付け処理 (金・パラジウムコート)
SOLDERABILITY IMPROVEMENT COAT (Au & Pd COAT)

下地メッキ: ニッケルメッキ 1.0 マイクロメートル以上
UNDER PLATING: NICKEL 1.0MICROMETER MINIMUM

△3 (全極数 / 2) = 偶数の場合に適用。
APPLY FOR (CIRCUIT/2)=EVEN.

4. 嵌合相手: 501531 シリーズ
MATE WITH: 501531 SERIES.

5. テール平坦度は、0.08 以下
テール及び金具の平坦度は、0.1 以下
TAIL COPLANARITY TO BE 0.08MAXIMUM.
TAIL AND FITTING NAIL COPLANARITY TO BE 0.1MAXIMUM.

△6 斜線部はパターン書き込み禁止範囲と半田禁止範囲を示す。
ただし、斜線部に補強金具と同一配線を配置する場合はレジストを施し、この部分に半田は無きこと。
NO PATTERN CIRCUIT AND NO SOLDER ALLOWED IN THE SHADED AREA.
HOWEVER, IF NEEDED, TO ADD A TRACE OF THE SAME CIRCUIT, PUT THE SOLDER-RESIST.
YET NO SOLDER ALLOWED IN THE AREA.

7. ELV and RoHS COMPLIANT.

REVISED EC NO: J2017-0224 DRWN: MISHIKAWA 2016/10/12 CHKD: TAKAHASHI 2016/10/12 APPR: MSASAO 2016/10/14	GENERAL TOLERANCES (UNLESS SPECIFIED)		DIMENSION STYLE MM ONLY		SCALE 10:1	DESIGN UNITS METRIC	THIRD ANGLE PROJECTION	
	0.25 UNDER	±	DRAWN BY RTAKEUCHI	DATE 2005/10/25	TITLE 0.4 B-TO-B CONN. HGT=1.3 REC ASSY WITH COVER -LEAD FREE-			
	0.25 OVER	0.5 UNDER ±	CHECKED BY THIRATA	DATE 2005/10/25				
	0.5 OVER	1.0 UNDER ±	APPROVED BY MSASAO	DATE 2005/10/25				
	0 OVER	10 UNDER ±0.2	MATERIAL NO.	DOCUMENT NO.	SHEET NO. 2 OF 2			
	10 OVER	30 UNDER ±0.25	SEE SHEET1		SD-501527-001			
	30 OVER	±0.3	THIS DRAWING CONTAINS INFORMATION THAT IS PROPRIETARY TO MOLEX ELECTRONIC TECHNOLOGIES, LLC AND SHOULD NOT BE USED WITHOUT WRITTEN PERMISSION					
	ANGULAR	±3 °						
	REV	DRAFT WHERE APPLICABLE MUST REMAIN WITHIN DIMENSIONS						

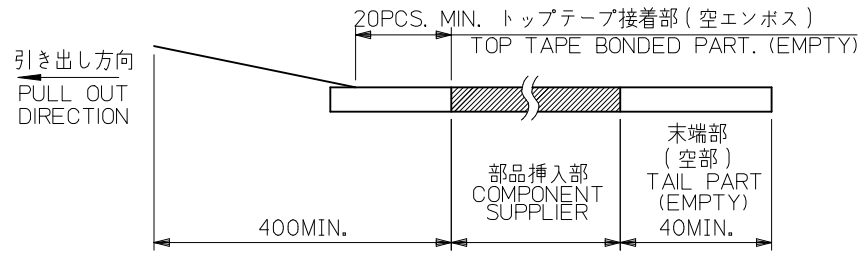
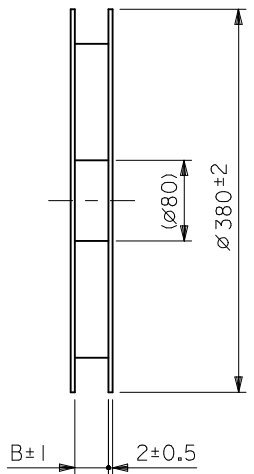
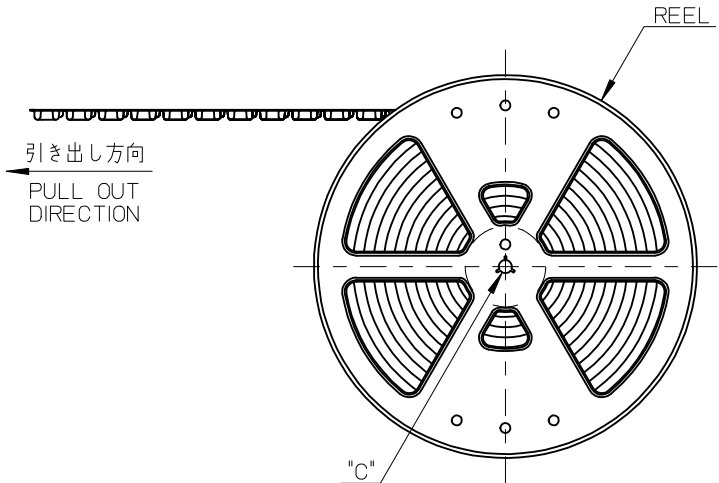

注記 NOTES

- 製品詳細寸法については製品単体図面を参照下さい。
RE DETAILED DIMENSION, SEE PRODUCT DRAWING.
- 梱包数量：6000 個/リール
NUMBER OF CONNECTORS：6000PCS/REEL
- リードテープ長さ LEAD TAPE LENGTH

- トップテープの剥離強度：JES-59 参照
剥離方向は下図参照。

PEELING OFF STRENGTH OF TOP TAPE : REFER TO JES-59
PEELING DIRECTION AS SHOWN IN FOLLOWING FIGURE.

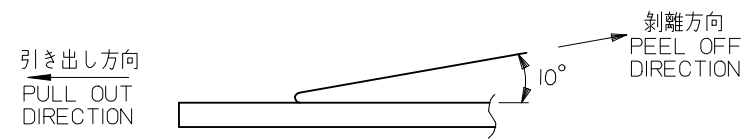

- 材料 MATERIAL
キャリアテープ (CARRIER TAPE)：ポリスチレン (POLYSTYRENE)
トップテープ (TOP TAPE)：PET, PE, PEF
リール (REEL)：ポリスチレン (PS) <リサイクル材を含む>
POLYSTYRENE (PS) <RECYCLE MATERIAL CONTAINED>

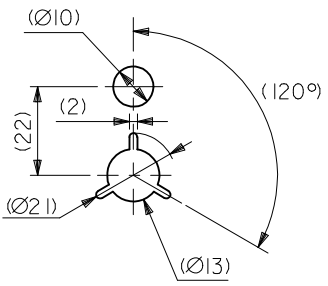

DETAIL "C"

MODEL NO. | 501527-**30

REVISED EC NO: J2016-1237 DRWN: MISHIKAWA 2016/06/09 CHKD: Y0110 2016/06/09 APPR: Y0110 2016/06/16	GENERAL TOLERANCES (UNLESS SPECIFIED)		DIMENSION STYLE		SCALE	DESIGN UNITS	THIRD ANGLE PROJECTION
	0.25 UNDER UNDER ±0.03		MM ONLY		---	METRIC	⊙ □
	0.25 OVER 0.5 UNDER ±0.05		DRAWN BY DATE		TITLE		
	0.5 OVER 1.0 UNDER ±0.1		RTAKEUCHI 2005/10/26		0.4 B-TO-B CONN. HGT=1.3 REC ASSY WITH COVER EMBSTP PKG -LEAD FREE-		
	1.0 OVER 10 UNDER ±---		CHECKED BY DATE		THIRATA 2005/10/26		
30 OVER 30 UNDER ±---		APPROVED BY DATE		MSASAO 2005/10/26			
ANGULAR ±--- °		MATERIAL NO.		DOCUMENT NO.			SHEET NO.
DRAFT WHERE APPLICABLE MUST REMAIN WITHIN DIMENSIONS		SEE CHART		SD-501527-002			1 OF 3
		SIZE A3		THIS DRAWING CONTAINS INFORMATION THAT IS PROPRIETARY TO MOLEX ELECTRONIC TECHNOLOGIES, LLC AND SHOULD NOT BE USED WITHOUT WRITTEN PERMISSION			

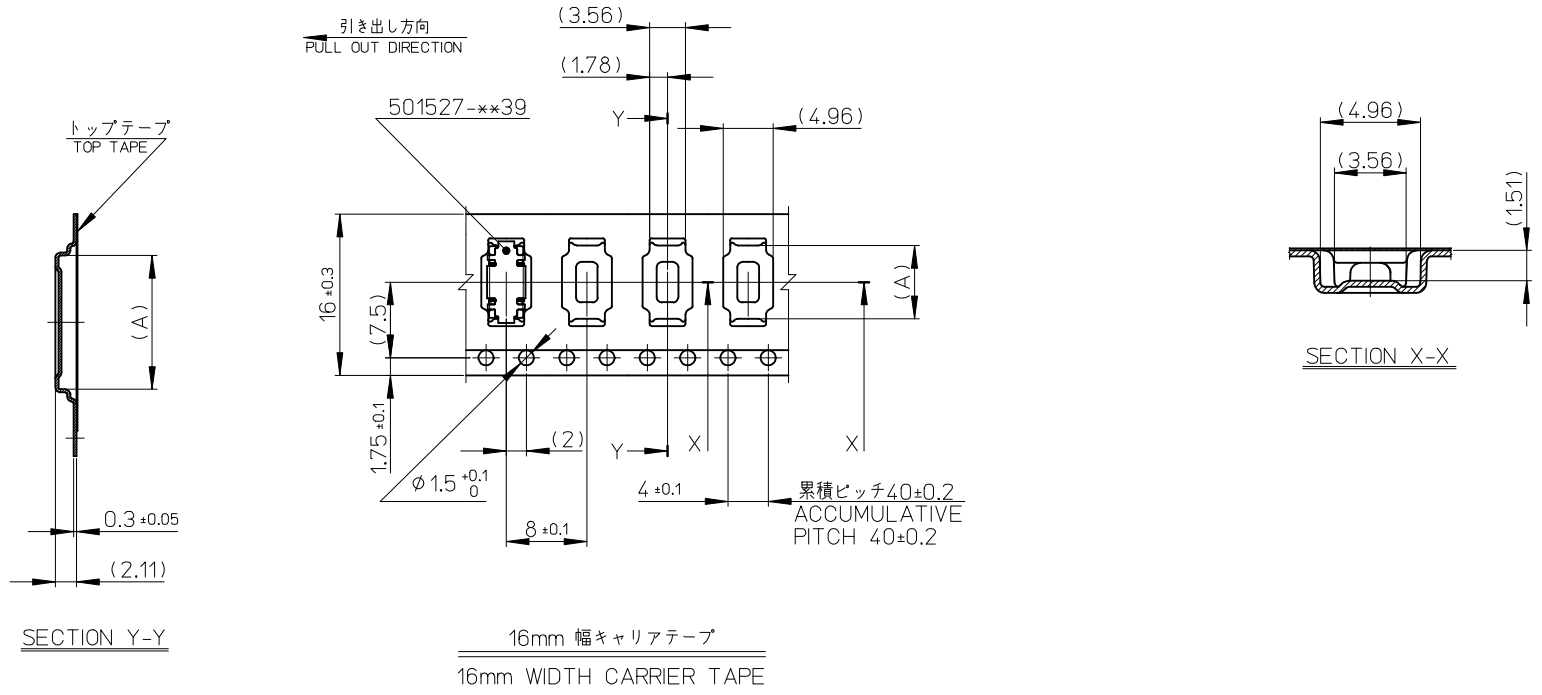

16	17.5	7.26	501527-0230	20
キャリアテープ幅 CARRIER TAPE WIDTH	B	(A)	MATERIAL No.	CKT.
			MODEL No.	501527-**-**30

REVISED EC NO: J2016-1237 DRWN: MISHIKAWA CHKD: Y0110 APPR: Y0110	GENERAL TOLERANCES (UNLESS SPECIFIED)			DIMENSION STYLE MM ONLY		SCALE ---	DESIGN UNITS METRIC	THIRD ANGLE PROJECTION
	0.25 UNDER	UNDER	±0.03	DRAWN BY	DATE	TITLE		
	0.25 OVER	0.5 UNDER	±0.05	RTAKEUCHI	2005/10/26	0.4 B-TO-B CONN. HGT=1.3 REC ASSY WITH COVER EMBSTP PKG -LEAD FREE-		
	0.5 OVER	1.0 UNDER	±0.1	THIRATA	2005/10/26			
	1.0 OVER	10 UNDER	±---	APPROVED BY	DATE	MATERIAL NO. DOCUMENT NO. SHEET NO.		
10 OVER	30 UNDER	±---	MSASAO	2005/10/26	SEE CHART SD-501527-002 2 OF 3			
30 OVER		±---	MATERIAL NO.					
ANGULAR	±---	°	SIZE A3			THIS DRAWING CONTAINS INFORMATION THAT IS PROPRIETARY TO MOLEX ELECTRONIC TECHNOLOGIES, LLC AND SHOULD NOT BE USED WITHOUT WRITTEN PERMISSION		
DRAFT WHERE APPLICABLE MUST REMAIN WITHIN DIMENSIONS								

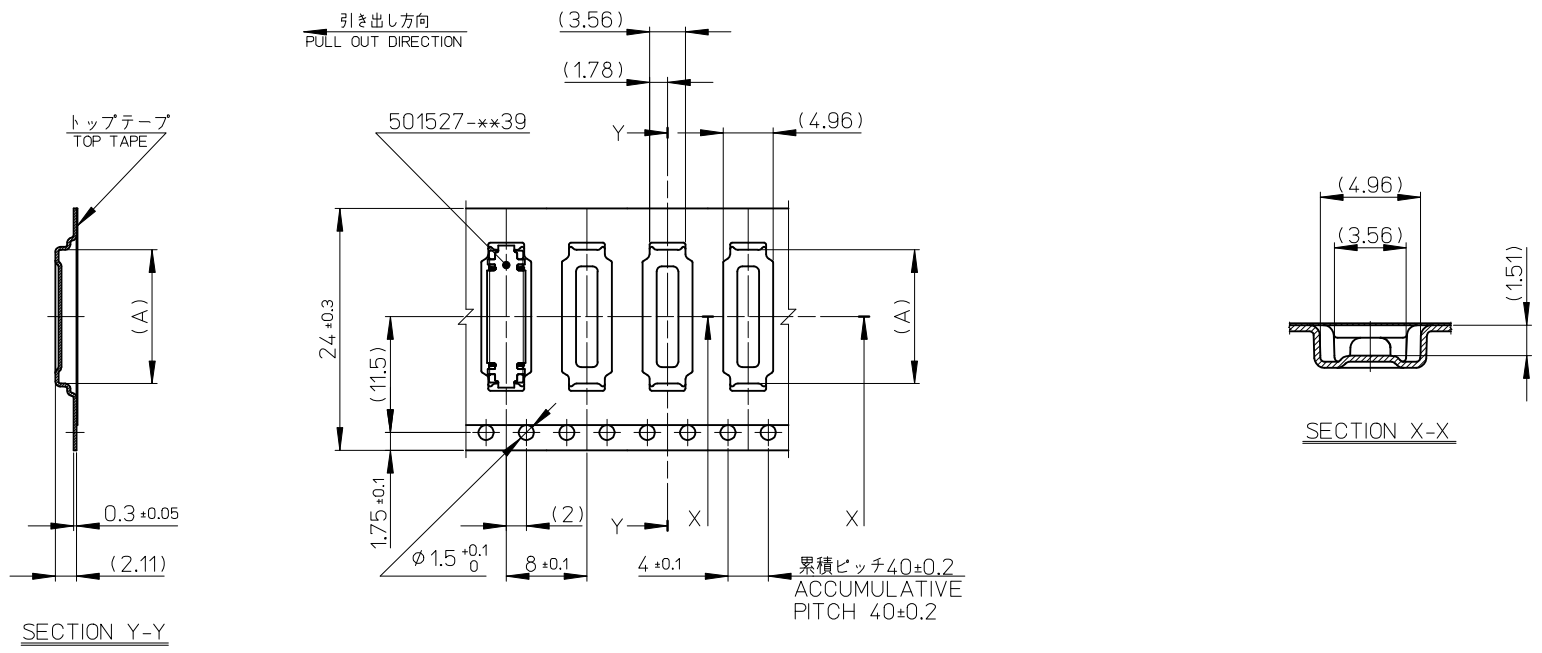

24mm 幅キャリアテープ
24mm WIDTH CARRIER TAPE

24	25.5	13.26	501527-0530	50
		11.26	501527-0430	40
		9.66	501527-3230	32
		9.26	501527-0330	30
キャリアテープ幅 CARRIER TAPE WIDTH		B	(A)	MATERIAL No. CKT.
			MODEL No.	501527-***30

REVISED EC NO: J2016-1237 DRWN: MISHIKAWA CHKD: Y0110 APPR: Y0110	GENERAL TOLERANCES (UNLESS SPECIFIED)			DIMENSION STYLE MM ONLY		SCALE ---	DESIGN UNITS METRIC	THIRD ANGLE PROJECTION	
	0.25 UNDER	UNDER	± 0.03	DRAWN BY	DATE	TITLE			
	0.25 OVER	0.5 UNDER	± 0.05	RTAKEUCHI	2005/10/26	0.4 B-TO-B CONN. HGT=1.3 REC ASSY WITH COVER EMBSTP PKG -LEAD FREE-			
	0.5 OVER	1.0 UNDER	± 0.1	THIRATA	2005/10/26				
	1.0 OVER	10 UNDER	± ---	APPROVED BY	DATE	molex DOCUMENT NO. SD-501527-002 SHEET NO. 3 OF 3			
10 OVER	30 UNDER	± ---	MSASAO	2005/10/26					
30 OVER		± ---	MATERIAL NO.						
ANGULAR	± --- °		SEE CHART						
DRAFT WHERE APPLICABLE MUST REMAIN WITHIN DIMENSIONS			SIZE A3	THIS DRAWING CONTAINS INFORMATION THAT IS PROPRIETARY TO MOLEX ELECTRONIC TECHNOLOGIES, LLC AND SHOULD NOT BE USED WITHOUT WRITTEN PERMISSION					