

THIS DOCUMENT IS SUBJECT TO CHANGE WITHOUT NOTICE. IT IS CONFIDENTIAL AND A PROPERTY OF AMPHENOL LTW. DISCLOSURE TO THIRD PARTY HAS TO BE AUTHORIZED BY AMPHENOL LTW.

REV.	ECN NO.	DATE	SIGN	DESCRIPTION
01		2022/09/30	Eagle	Rev.01 to Rev.A

DT-HCM-XXRMM-RHA30

For 12P

- G3: 3Pin
- G4: 4Pin
- 06: 6Pin
- 08: 8Pin
- 12: 12Pin

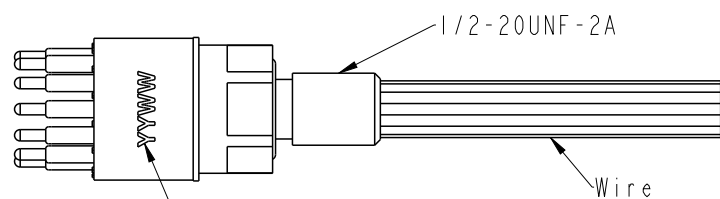
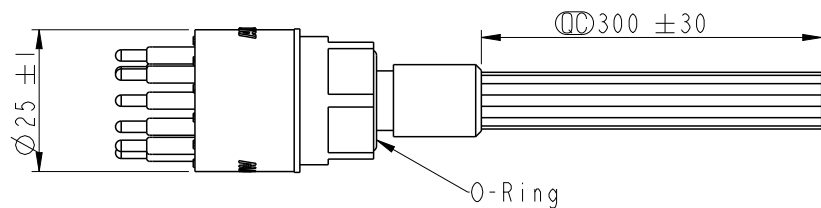
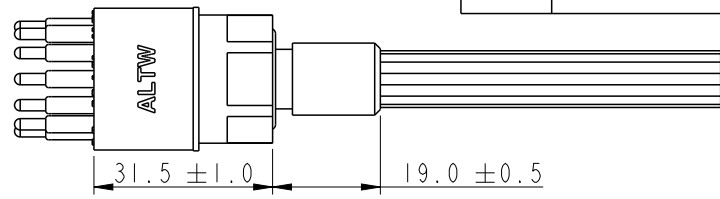
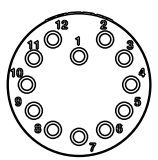

YY(年)
WW(週)

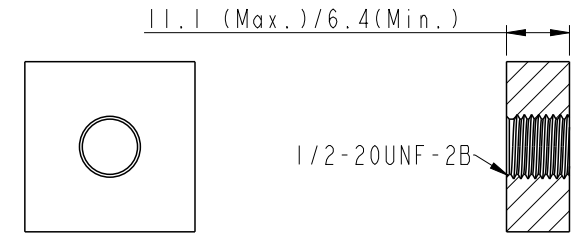

Panel cut out (screw type)

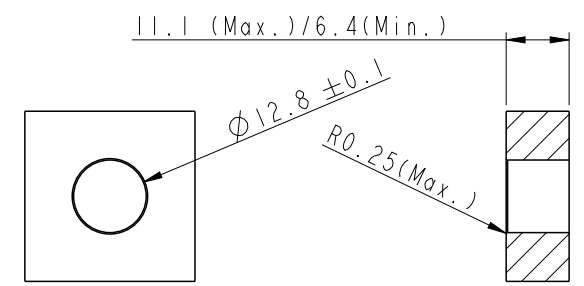

Panel cut out (hole type)

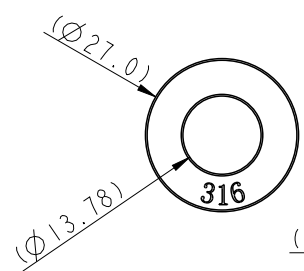

Washer

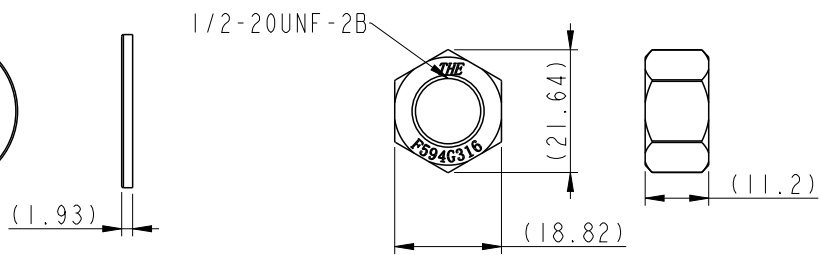

Nut

- Note:
- * \varnothing Important Dimension.
 - * Waterproof Rate: Hadopelagic 7000M, Mated.
 - * Connector
 - Housing : Rubber, Black.
 - Pin : Copper Alloy, Gold Plated.
 - O-Ring: Rubber, Black.
 - Shield: Metal.
 - Nut: Metal.
 - Washer: Metal.
 - * Wire:
 - UL10393 18 AWG, OD 1.81mm for 3P/4P
 - UL1815 22 AWG, OD 1.46mm for 6P/8P
 - UL1815 20 AWG, OD 1.56mm for 12P
 - * Washer and nut are packed separately in PE bag.

UNIT: mm TOLERANCE ±0.5	TITLE DT, HAD CIRCULAR MICRO REAR FASTENED, M, M			<h1 style="margin: 0;">Amphenol LTW</h1> <p style="margin: 0;">安費諾亮泰企業股份有限公司</p>	ITEM NO	DRAWN BY Eagle	DATE 2022/09/30
	SCALE 1:1	SIZE A4	SHEET 1 OF 4		DWG NO DT-HCM-XXRMM-RHA30	CHECKED BY Aric	DATE 2022/09/30
	REV. A	WC-REV. A.5	QC: Inspection item		CUSTOMER ALTW	APPROVED BY Max	DATE 2022/09/30

THIS DOCUMENT IS SUBJECT TO CHANGE WITHOUT NOTICE. IT IS CONFIDENTIAL AND A PROPERTY OF Amphenol LTW. DISCLOSURE TO THIRD PARTY HAS TO BE AUTHORIZED BY Amphenol LTW.

Special square thread
特殊方形螺牙

For 3P/4P/6P/8P

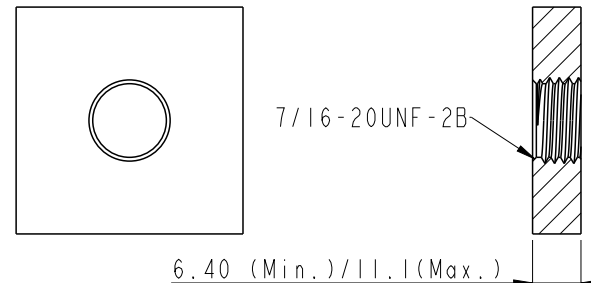
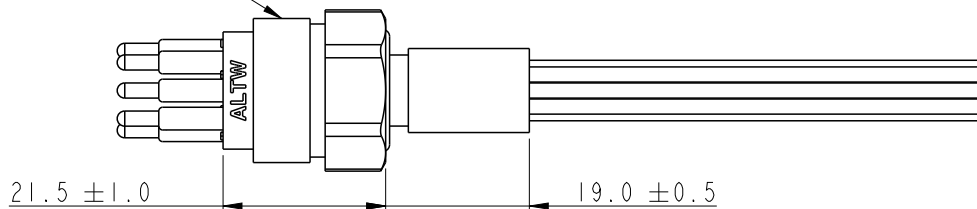

Panel cut out (screw type)

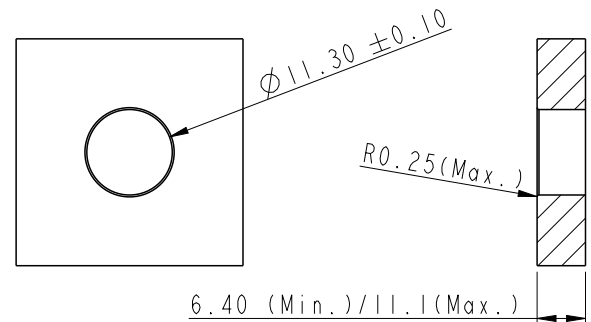
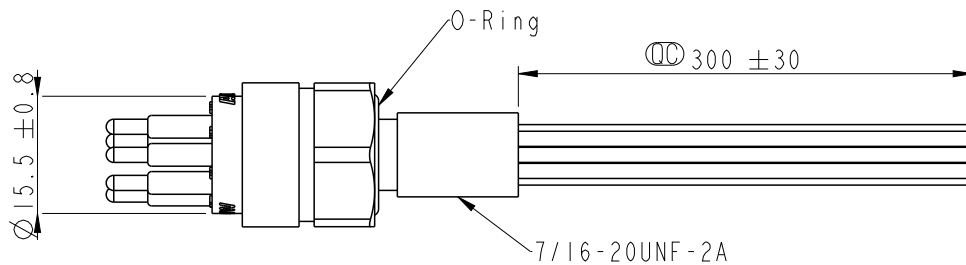

Panel cut out (hole type)

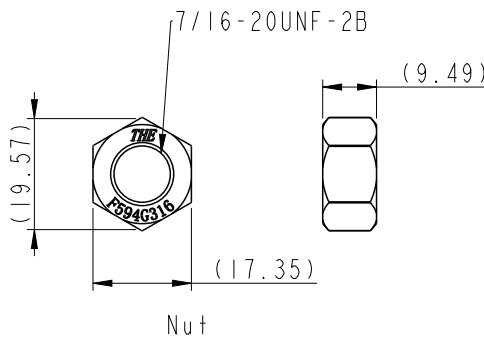
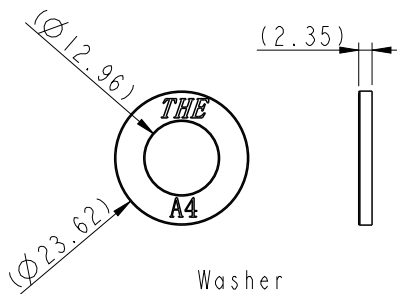
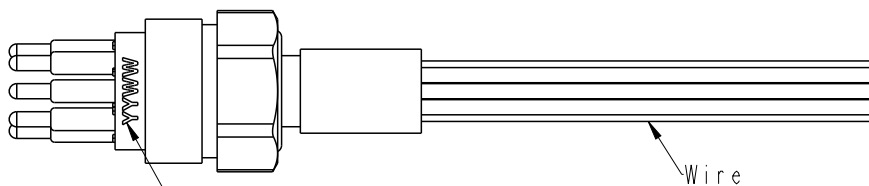

UNIT: mm

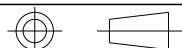

TITLE DT, HAD CIRCULAR MICRO REAR FASTENED, M, M			
SCALE 1:1	SIZE A4	SHEET 2 OF 4	
REV. A	WC-REV. A.5	☉: Inspection item	

Amphenol LTW
安費諾亮泰企業股份有限公司

ITEM NO	DRAWN BY Eagle	DATE 2022/09/30
DWG NO DT-HCM-XXRMM-RHA30	CHECKED BY Aric	DATE 2022/09/30
CUSTOMER ALTW	APPROVED BY Max	DATE 2022/09/30

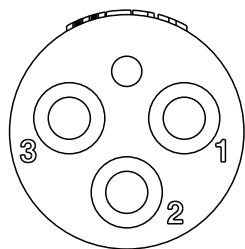

Pin Assignment(Front View)

- Pin Out (3P)
 1 Black(黑) 18AWG
 2 White(白) 18AWG
 3 Red(紅) 18AWG

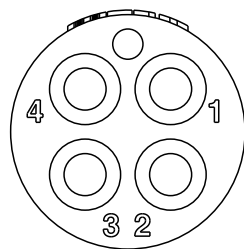

Pin Assignment(Front View)

- Pin Out (4P)
 1 Black(黑) 18AWG
 2 White(白) 18AWG
 3 Red(紅) 18AWG
 4 Green(綠) 18AWG

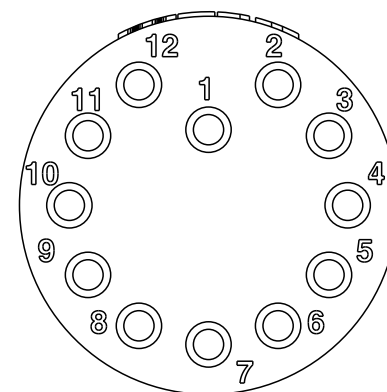

Pin Assignment(Front View)

- Pin Out (12P)
 1 Black(黑) 20AWG
 2 White(白) 20AWG
 3 Red(紅) 20AWG
 4 Green(綠) 20AWG
 5 Orange(橙) 20AWG
 6 Blue(藍) 20AWG
 7 White/Black(白/黑) 20AWG
 8 Red/Black(紅/黑) 20AWG
 9 Green/Black(綠/黑) 20AWG
 10 Orange/Black(橙/黑) 20AWG
 11 Blue/Black(藍/黑) 20AWG
 12 Black/White(黑/白) 20AWG

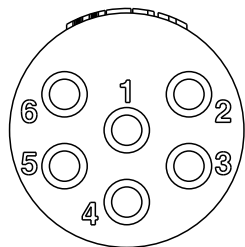

Pin Assignment(Front View)

- Pin Out (6P)
 1 Black(黑) 22AWG
 2 White(白) 22AWG
 3 Red(紅) 22AWG
 4 Green(綠) 22AWG
 5 Orange(橙) 22AWG
 6 Blue(藍) 22AWG

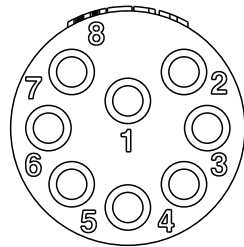

Pin Assignment(Front View)

- Pin Out (8P)
 1 Black(黑) 22AWG
 2 White(白) 22AWG
 3 Red(紅) 22AWG
 4 Green(綠) 22AWG
 5 Orange(橙) 22AWG
 6 Blue(藍) 22AWG
 7 White/Black(白/黑) 22AWG
 8 Red/Black(紅/黑) 22AWG

UNIT:mm
 TOLERANCE

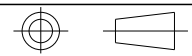

TITLE DT, HAD CIRCULAR MICRO REAR FASTENED, M, M			
SCALE 1:2	SIZE A4	SHEET 3 OF 4	
REV. A	WC-REV.	QC: Inspection item	

Amphenol LTW
 安費諾亮泰企業股份有限公司

ITEM NO	DRAWN BY Eagle	DATE 2022/09/30
DWG NO DT-HCM-XXRMM-RHA30	CHECKED BY Aric	DATE 2022/09/30
CUSTOMER ALTW	APPROVED BY Max	DATE 2022/09/30

THIS DOCUMENT IS SUBJECT TO CHANGE WITHOUT NOTICE. IT IS CONFIDENTIAL AND A PROPERTY OF Amphenol LTW. DISCLOSURE TO THIRD PARTY HAS TO BE AUTHORIZED BY Amphenol LTW.

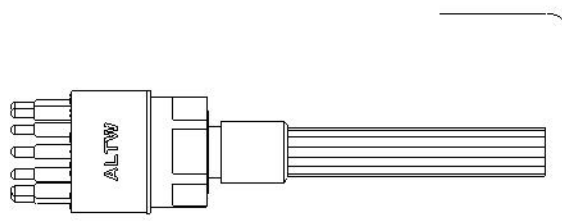

3P/4P/6P/8P: 10PCS(Max.)
12P: 8PCS(Max.)

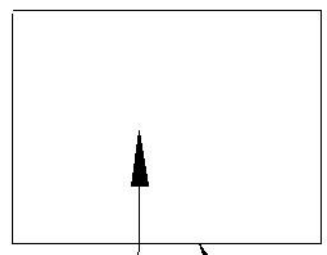

Tray

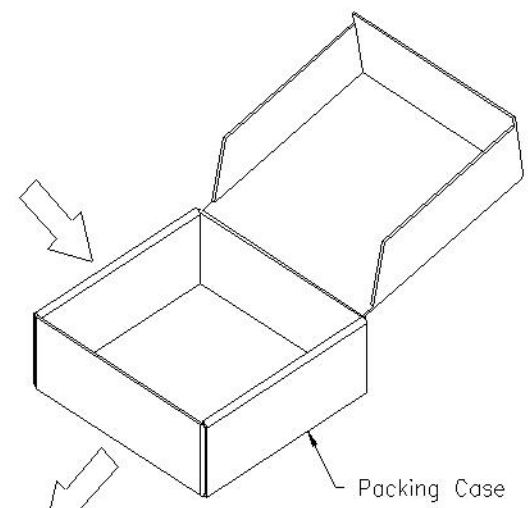

Packing Case

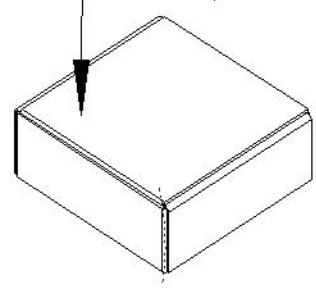

年 月 ALTW 合格品 RoHS2.0

料號: _____ 廠商: 昆山安費諾正日電子

數量: _____ PC 日期: _____

Lot No: _____ 版本: _____

採購單號: _____

廠商料號: _____

UNIT: mm

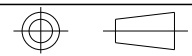

TOLERANCE
±0.5

TITLE DT, HAD CIRCULAR MICRO REAR FASTENED, M, M			
SCALE 1:1	SIZE A4	SHEET 4 OF 4	
REV. A	WC-REV. A.5	QC: Inspection item	

Amphenol LTW

安費諾亮泰企業股份有限公司

ITEM NO	DRAWN BY Eagle	DATE 2022/09/30
DWG NO DT-HCM-XXRMM-RHA30	CHECKED BY Aric	DATE 2022/09/30
CUSTOMER ALTW	APPROVED BY Max	DATE 2022/09/30