



## HCR8065M

### Rotatable Shell Omni-Directional Antenna 806-960 MHz/1710-2200 MHz

The HCR Rotatable Shell Omnidirectional Antenna is a tough low-profile antenna for outdoor or indoor applications. This antenna provides frequency agility, low visibility, wide bandwidth and a low angle radiation pattern that is superior to traditional gain antennas in most applications.

The HCR Rotatable Shell Omnidirectional Antenna is available in various industry standard mounting configurations including a threaded permanent stud mount model for vandal resistant mounting on brackets, panels, ceilings or any other kind of housing.

#### FEATURES AND BENEFITS

- Multi-band operation: 806-960 MHz/1710-2200 MHz
- Meets IP67 protection rating for dust tight seal and temporary water immersion
- Permanent mount provides vandal resistant protection for remote installations
- Conformance to RoHS

#### MARKETS

- Security/Public Safety
- Commercial and Industrial- M2M
- Transportation
- Electric, Gas, and Water Utilities
- Retail, Consumer & Home
- Fixed Radio Applications

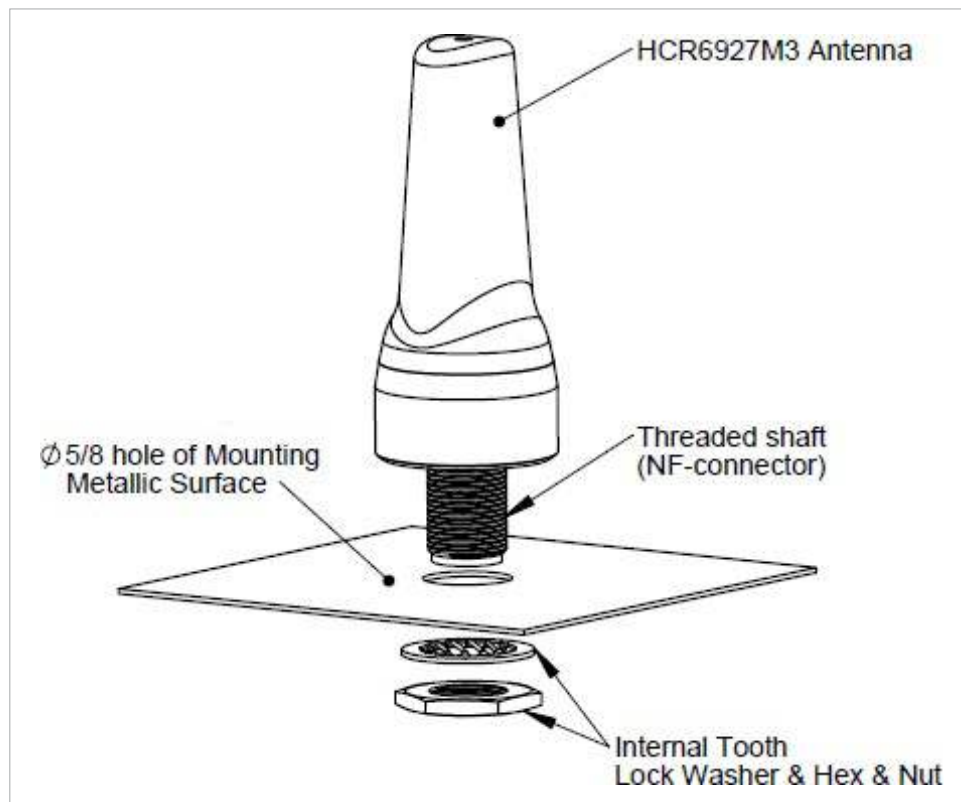

## SPECIFICATIONS

Model	HCR8065M3NBL-001 HCR8065M3PBL-001 HCR8065M3NBN-001 HCR8065M3PBN-001	HCR8065M3NWL-001 HCR8065M3PWL-001 HCR8065M3NWN-001 HCR8065M3PWN-001
Frequency	806-960 MHz	1710-2200 MHz
Gain (Typical)	2.1 dBi	2.6 dBi
Gain (Max)	2.2 dBi	3.2 dBi
VSWR (2" x 2" ground plane)	< 2:1	
Max Input Power	10 watts	
Radiation Pattern	Omnidirectional	
Polarization	Vertical	
Normal Impedance	50 Ohm	
Antenna Dimension ("")	83.3 H x 36.5 D mm (3.47 x 1.4)	
Antenna Color	Black/White	
Weight (lbs)	NMO: 106 g (0.23) P-Mount: 192.5 g (0.42)	
Wind Survival (mph)	282 km/h (175 )	
Mounting	NMO/P-Mount	
Operating Temperature	-30° C to 70° C	
Storage Temperature	-40° C to 85° C	
Ingression Protection	IP67	
RoHS Compliance	Yes	

HCR8065M3NBL-001 NMO mount black w/Logo  
HCR8065M3PBL-001 P mount black w/logo  
HCR8065M3NBN-001 NMO mount black no logo  
HCR8065M3PBN-001 P mount black no logo

HCR8065M3NWL-001 NMO mount white w/logo  
HCR8065M3PWL-001 P mount white w/logo  
HCR8065M3PBN-001 NMO mount white no logo  
HCR8065M3PWN-001 P mount white no logo

## RADIATION PATTERNS

### 806 MHz

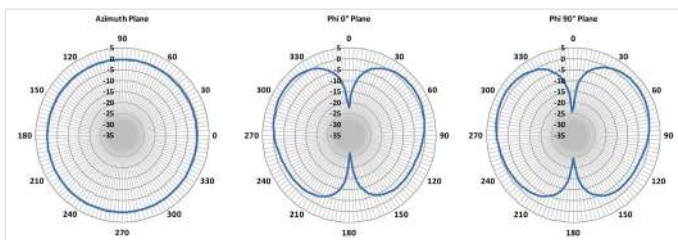

### 840 MHz

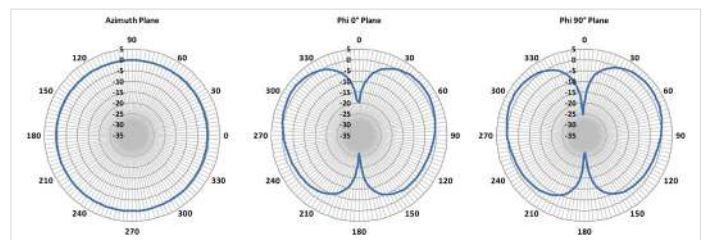

## 920 MHz

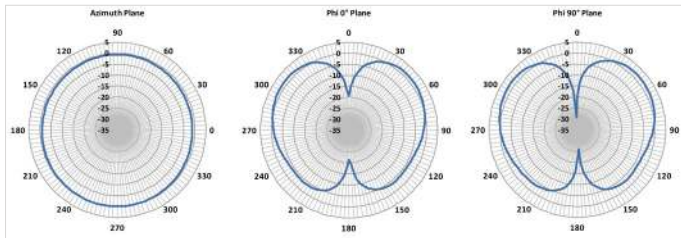

## 1850 MHz

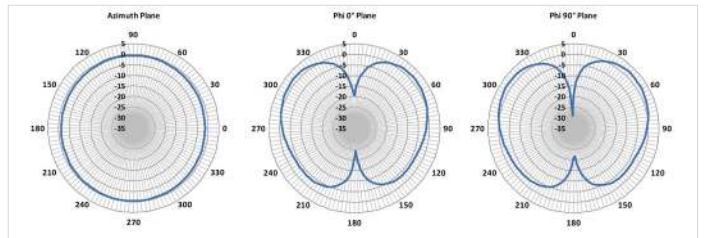

## 1710 MHz

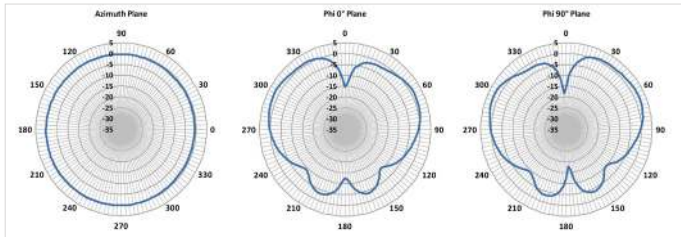

## 1950 MHz

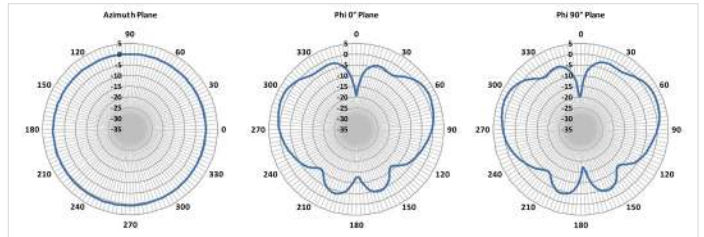

## 1990 MHz

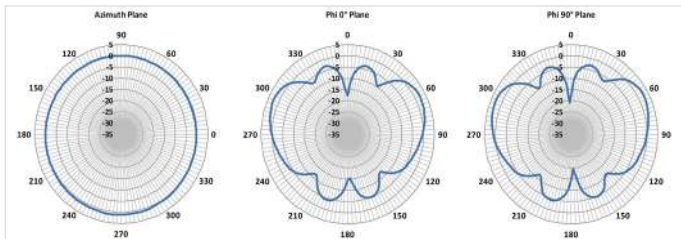

## 2200 MHz

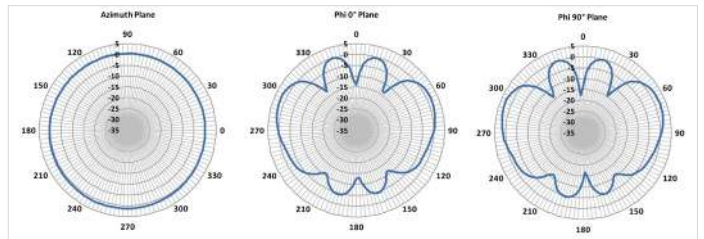

### TE TECHNICAL SUPPORT CENTER

USA:	+1 (800) 522-6752
Canada:	+1 (905) 475-6222
Mexico:	+52 (0) 55-1106-0800
Latin/S. America:	+54 (0) 11-4733-2200
Germany:	+49 (0) 6251-133-1999
UK:	+44 (0) 800-267666
France:	+33 (0) 1-3420-8686
Netherlands:	+31 (0) 73-6246-999
China:	+86 (0) 400-820-6015

### te.com

TE Connectivity, TE Connectivity (logo) and Every Connection Counts are trademarks. All other logos, products and/or company names referred to herein might be trademarks of their respective owners.

The information given herein, including drawings, illustrations and schematics which are intended for illustration purposes only, is believed to be reliable.

However, TE Connectivity makes no warranties as to its accuracy or completeness and disclaims any liability in connection with its use. TE Connectivity's obligations shall only be as set forth in TE Connectivity's Standard Terms and Conditions of Sale for this product and in no case will TE Connectivity be liable for any incidental, indirect or consequential damages arising out of the sale, resale, use or misuse of the product. Users of TE Connectivity products should make their own evaluation to determine the suitability of each such product for the specific application.

TE warrants to the original end user customer of its products that its products are free from defects in material and workmanship. Subject to conditions and limitations TE will, at its option, either repair or replace any part of its products that prove defective because of improper workmanship or materials. This limited warranty is in force for the useful lifetime of the original end product into which the TE product is installed. Useful lifetime of the original end product may vary but is not to exceed five (5) years from the original date of the end product purchase.

©2021 TE Connectivity. All Rights Reserved.

11/21 Original

