

PRODUCT NUMBER

51724-ABBCCDDDE0_

SEE NOTE 1

SEE DETAIL A

SEE DETAIL B

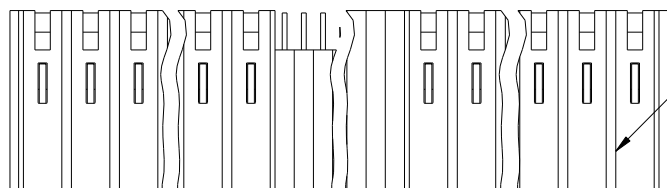
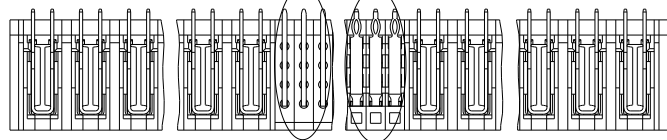

SEE NOTE 9

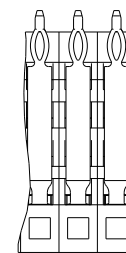
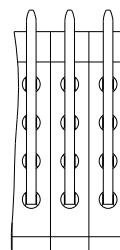

DETAIL A SCALE 2:1 FOR SOLDER TO BOARD ONLY

DETAIL B SCALE 2:1 FOR PRESS FIT ONLY

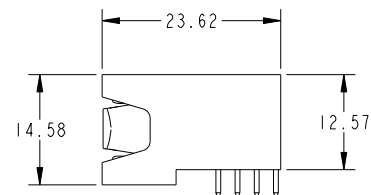
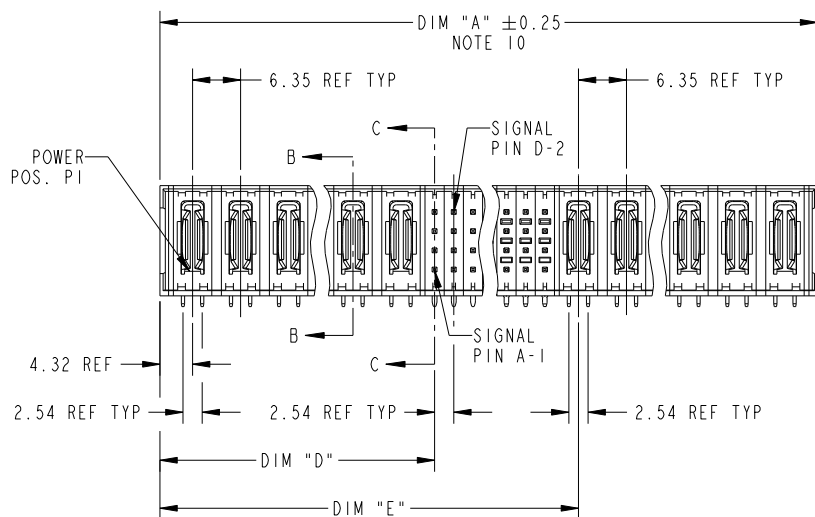

Copyright FCI.

spec ref	*	dr	X Q Wang	2010/11/17	projection 	MM ←→	size	A4	scale	1:1
tolerance std	ASME Y14.5	eng	Ruan MT	2015/09/30			ecn no	ELX-DG-21593-1		
TOLERANCES UNLESS OTHERWISE SPECIFIED		chr	Fancy Zhang	2015/09/30			rel level	Released		
surface	✓	appr	Pei-Ming Zheng	2015/09/30	product family	PwrBlade	rev	51724	M	
ASME Y14.5	linear	0.X	±0.5	www.fci.com	title	R/A HEADER W/O GUIDE PIN POWER / SIGNAL / POWER	cat. no.	* Product - Customer Drw	sheet 1 of 3	
		0.XX	±0.25							
		0.XXX	±0.100							
	angular	0°	±2°							



PRODUCT NUMBER	DIM	LENGTH FORMULAS (SEE NOTE 10)
51724-ABBCCDDDE0_	DIM "A"	$6.35 \times BB + 2.54 \times (CCC/4) + 6.35 \times DD + 2.29$ (NOTE 10)
SEE NOTE 1	DIM "D"	$6.35 \times BB + 2.41$
	DIM "E"	$6.35 \times BB + 2.54 \times (CCC/4) + 4.32$
	DIM "F"	$6.35 \times BB + 2.54 \times (CCC/4) + 6.35 \times DD + 3.05$
	DIM "G"	$6.35 \times BB - 0.64$
	DIM "H"	$6.35 \times BB + 2.54 \times (CCC/4)$

CONNECTOR NOTES

- ①. PRODUCT NUMBER CODE:
 51724 - A BB CCC DD E 0 LF
- NO THIS SUFFIX: 100u"/2.54um SnPb ON PCB INTERFACE
 - ADD THIS SUFFIX: 78u"/2.00um Sn OR 5u" Au ON PCB INTERFACE
 - ALWAYS '0' (ZERO)(NOTE 8)
 - TAIL LENGTH (NOTE 7)
 - NUMBER OF RIGHT END POWER CONTACTS (NOTE 6)
 - NUMBER OF SIGNAL CONTACTS (NOTE 5)
 - NUMBER OF LEFT END POWER CONTACTS (NOTE 4)
 - PLATING (NOTE 3)
 - BASE NUMBER



- ⑧. BOARD RETENTION IS NOT AVAILABLE WITH GUIDELESS ENDS.
- ⑨. MANUFACTURE'S NAME, P/N, AND DATE CODE TO APPEAR ON THIS SURFACE.
- ⑩. THE MAXIMUM OVERALL LENGTH (DIM A) OF A PART IS 203.2
- 11. PRODUCT SPECIFICATION GS-12-149 APPLICATION SPECIFICATION BUS-20-067
- 12. REFERENCE 51697 FOR SELECT LOAD/FMLB WORKSHEET

PCB NOTES:

- 13. ALL DIMENSIONS ARE BASIC UNLESS OTHERWISE SPECIFIED.
- ⑭. ALL THROUGH HOLES ARE LOCATED WITH A TRUE POSITION OF 0.10
- 15. ALL HOLE DIAMETERS ARE FINISHED HOLE SIZE.
- ⑯. $\varnothing 1.151 \pm 0.025$ DRILLED HOLES PLATED WITH 0.008 MIN SnPb or Sn OVER 0.03 TO 0.08 Cu PLATING TO ACHIEVE A 1.02 ± 0.07 HOLE.
- 17. A  SYMBOL WILL BE NEXT TO ANY DIMENSION, VIEW, OR NOTE WHICH HAS BEEN MODIFIED WITH THE CURRENT DRAWING REVISION.
- ⑰.  CONNECTOR KEEP OUT ZONE

- ②. HOUSING MATERIAL: GLASS FILLED V-O HIGH TEMP THERMO PLASTIC.
 SIGNAL CONTACT MATERIAL: COPPER ALLOY
 POWER CONTACT MATERIAL: COPPER ALLOY
- ③. PLATING OPTION:
 1 = SEE PRINT 10064183 FOR PLATING SPEC OF 51724-IBBCC00E0; 51724-IBBCC00E0LF
- ④. LEFT END POWER CONTACTS, 01 THRU 19 AVAILABLE.
 MAXIMUM OF 20 POWER CONTACTS PER CONNECTOR.
- ⑤. SIGNAL CONTACTS, 004 TO 148 AVAILABLE.
- ⑥. RIGHT END POWER CONTACTS, 01 TO 19 AVAILABLE.
 MAXIMUM OF 20 POWER CONTACTS PER CONNECTOR.

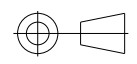
-  ⑦. TAIL LENGTH:
 A = 3.43 SOLDER TO BOARD
 B = 4.19 SOLDER TO BOARD
 C = 3.43 PRESS FIT
 D = 2.34 SOLDER TO BOARD

dr	X Q Wang	2010/11/17	projection 	MM 	size	A4	scale	1:1
eng	Ruan MT	2015/09/30			ecn no	ELX-DG-21593-1		
chr	Fancy Zhang	2015/09/30			product family	PwrBlade	rel level	Released
appr	Pei-Ming Zheng	2015/09/30	product family		PwrBlade	rel level	Released	
		title	R/A HEADER W/O GUIDE PIN			dwg no	51724	
www.fci.com		cat. no.	Product - Customer Drw			rev	M	
						sheet	2 of 3	



Copyright FCI.

PRODUCT NUMBER

51724-ABBCCDDDE0_

SEE NOTE 1

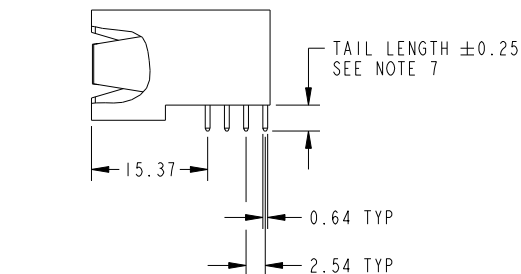
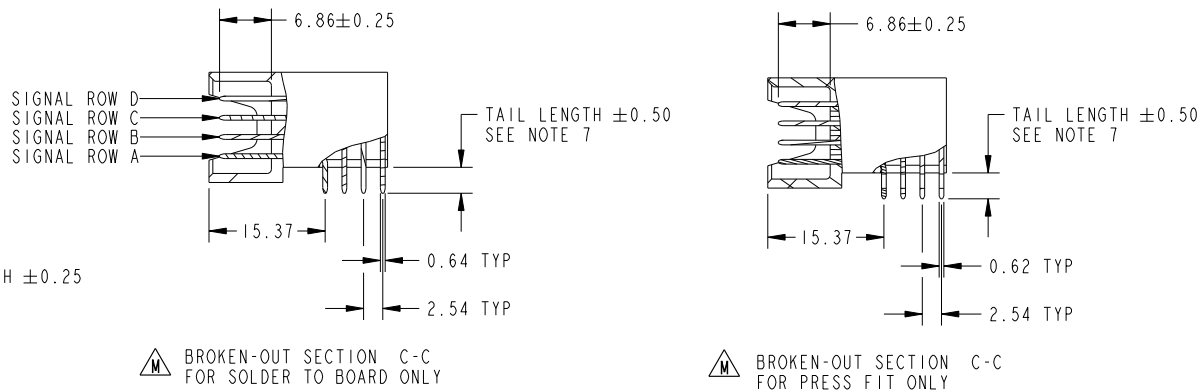

BROKEN-OUT SECTION B-B FOR SOLDER TO BOARD ONLY

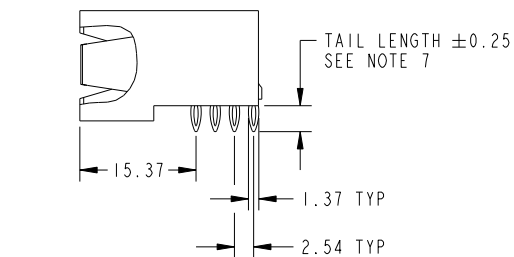

BROKEN-OUT SECTION B-B FOR PRESS FIT ONLY

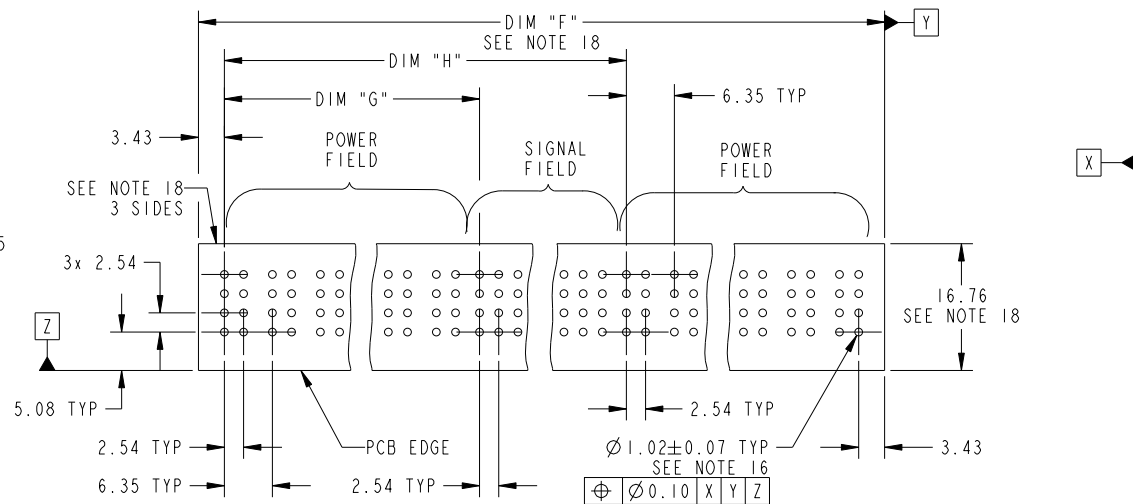

RECOMMENDED PCB LAYOUT

dr	X Q Wang	2010/11/17	projection 	MM ←→	size	A4	scale	1:1
eng	Ruan MT	2015/09/30			ecn no	ELX-DG-21593-1		
chr	Fancy Zhang	2015/09/30			rel level	Released		
appr	Pei-Ming Zheng	2015/09/30	product family	PwrBlade		rel level	Released	
		title	R/A HEADER W/O GUIDE PIN		dwg no	51724		rev
www.fci.com		cat. no.	POWER / SIGNAL / POWER					M
			Product - Customer Drw			sheet 3 of 3		



Copyright FCI.