



SFP28

TE Internal #: 1367073-2

SFP, SFP+ & zSFP+, Connector, Data Rate (Max) 4 Gb/s, SFP, Not Optional, Surface Mount, Cable-to-Board, 20 Position, .031 in [.8 mm] Centerline

[View on TE.com >](#)

Connectors > Pluggable IO Connectors & Cages > SFP, SFP+ & zSFP+ > SFP Connectors

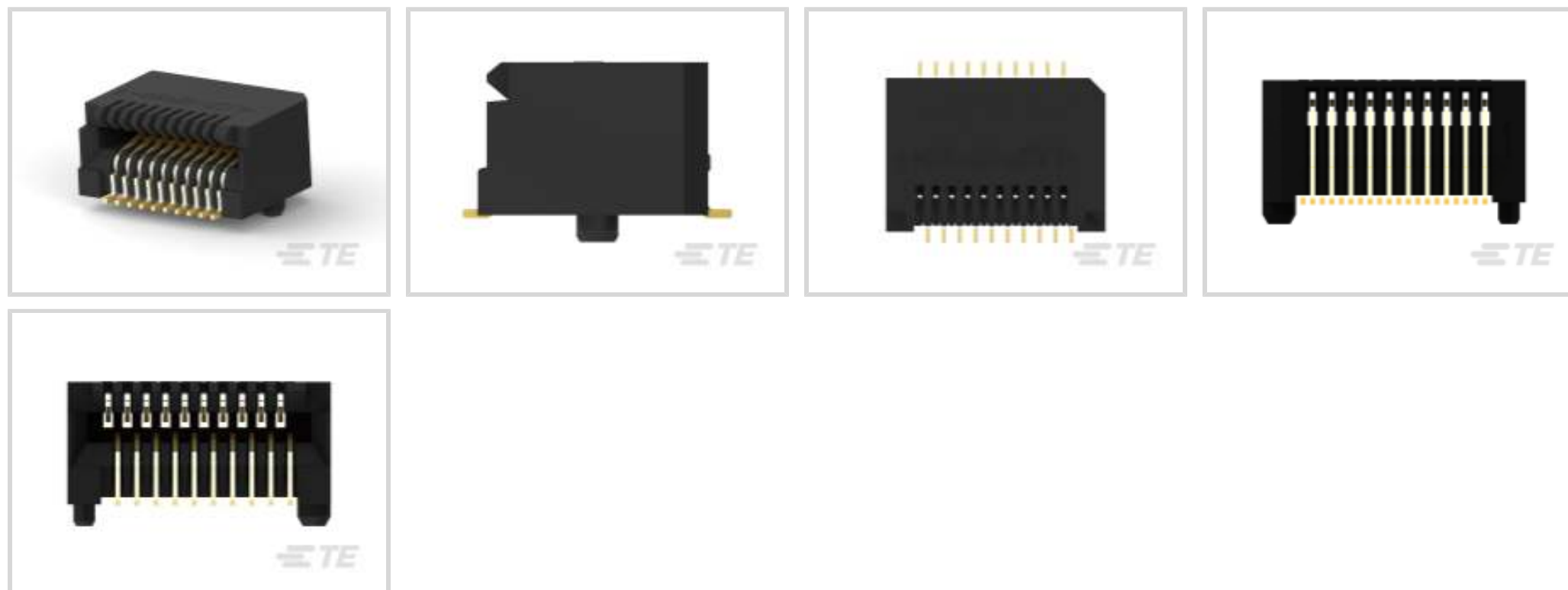

Pluggable I/O Product Type: **Connector**

Data Rate (Max): **4 Gb/s**

Pluggable I/O Applications: **SFP**

Lightpipe Options: **Not Optional**

Termination Method to Printed Circuit Board: **Surface Mount**

[All SFP Connectors \(10\)](#)

Features

Product Type Features

Form Factor	SFP
Pluggable I/O Product Type	Connector
Lightpipe Options	Not Optional
Connector System	Cable-to-Board
Sealable	No
Connector & Contact Terminates To	Printed Circuit Board

Configuration Features

Number of Positions	20
---------------------	----

Electrical Characteristics

Data Rate (Max)	4 Gb/s
-----------------	--------

Contact Features

Contact Mating Area Plating Material Thickness	.76 μm[29.92 μin]
--	-------------------



Contact Mating Area Plating Material	Gold
--------------------------------------	------

Contact Current Rating (Max)	.5 A
------------------------------	------

Termination Features

Termination Method to Printed Circuit Board	Surface Mount
---	---------------

Mechanical Attachment

Connector Mounting Type	Board Mount
-------------------------	-------------

Housing Features

Centerline (Pitch)	.8 mm [.031 in]
--------------------	-----------------

Usage Conditions

Operating Temperature Range	-55 – 85 °C [-67 – 185 °F]
-----------------------------	----------------------------

Operation/Application

For Use With Pluggable I/O Products	SFP Cage
-------------------------------------	----------

Pluggable I/O Applications	SFP
----------------------------	-----

Circuit Application	Power & Signal
---------------------	----------------

Industry Standards

UL Flammability Rating	UL 94V-0
------------------------	----------

Packaging Features

Packaging Method	Reel
------------------	------

Product Compliance

[For compliance documentation, visit the product page on TE.com>](#)

EU RoHS Directive 2011/65/EU	Compliant
------------------------------	-----------

EU ELV Directive 2000/53/EC	Compliant
-----------------------------	-----------

China RoHS 2 Directive MIIT Order No 32, 2016	No Restricted Materials Above Threshold
---	---

EU REACH Regulation (EC) No. 1907/2006	Current ECHA Candidate List: JUNE 2023 (235) Candidate List Declared Against: JUNE 2023 (235) Does not contain REACH SVHC
--	---

Halogen Content	Low Halogen - Br, Cl, F, I < 900 ppm per homogenous material. Also BFR/CFR/PVC Free
-----------------	---

Solder Process Capability	Reflow solder capable to 260°C
---------------------------	--------------------------------

Product Compliance Disclaimer

This information is provided based on reasonable inquiry of our suppliers and represents our current actual knowledge based on the information they provided. This information is subject to change. The part numbers that TE has identified as EU RoHS compliant have a maximum concentration of 0.1% by weight in homogenous materials for lead, hexavalent chromium, mercury, PBB, PBDE, DBP, BBP, DEHP, DIBP, and 0.01% for cadmium, or qualify for an exemption to these limits as defined in the Annexes of Directive 2011/65/EU (RoHS2). Finished electrical and electronic equipment products will be CE marked as required by Directive 2011/65/EU. Components may not be CE marked. Additionally, the part numbers that TE has identified as EU ELV compliant have a maximum concentration of 0.1% by weight in homogenous materials for lead, hexavalent chromium, and mercury, and 0.01% for cadmium, or qualify for an exemption to these limits as defined in the Annexes of Directive 2000/53/EC (ELV). Regarding the REACH Regulation, the information TE provides on SVHC in articles for this part number is based on the latest European Chemicals Agency (ECHA) 'Guidance on requirements for substances in articles' posted at this URL: <https://echa.europa.eu/guidance-documents/guidance-on-reach>

Compatible Parts



TE Part # CAT-SF59-C76264
SFP Connectors



TE Part # 1367629-2
cage assy, 20 press fit, sfp w

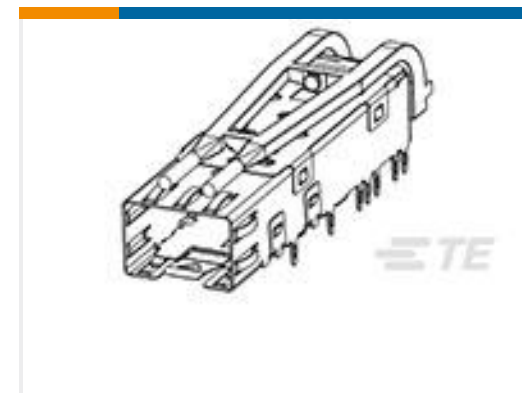

TE Part # 2170614-1
cage assy, 20 press fit, sfp w



TE Part # 2227023-1
CAGE ASSY PRESS FIT, SFP



TE Part # 2227303-1
CAGE ASSEMBLY, SFP, .140 SOLDE



TE Part # 2227303-2
CAGE ASSEMBLY, SFP, .071 TAIL



TE Part # 2227302-1
CAGE ASSY, PRESS FIT, SFP

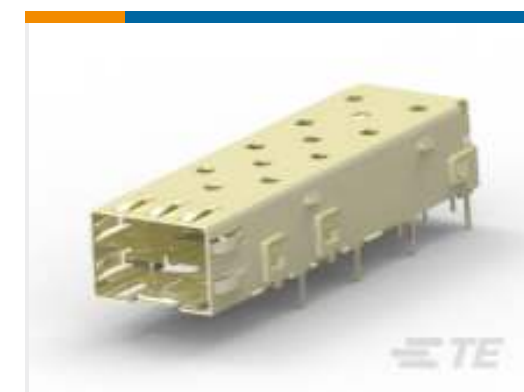

TE Part # 2227303-3
CAGE ASSEMBLY, SFP, .071 TAIL

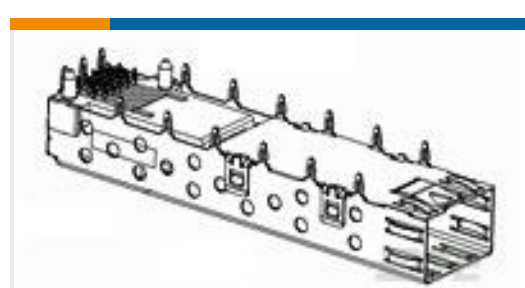

TE Part # 2170039-1
1X1SFP CAGE ASSY & PT
CONNECTOR ASSY

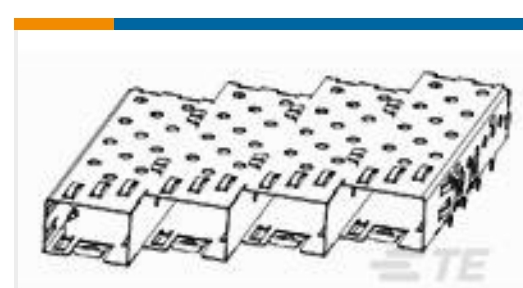

TE Part # 2170167-1
SFP 1X4 ANGLED CAGE ASSY, PRESS
FIT



TE Part # 2227317-1
press fit cage assy, single with lp

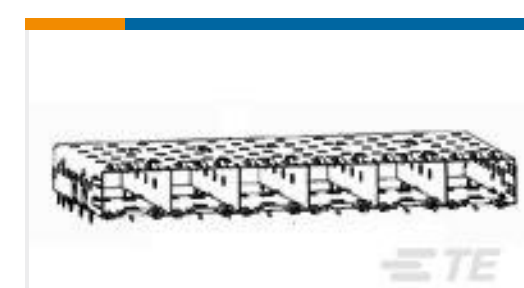

TE Part # 2170080-1
SFP 1X6 CAGE ASSY, PRESS FIT

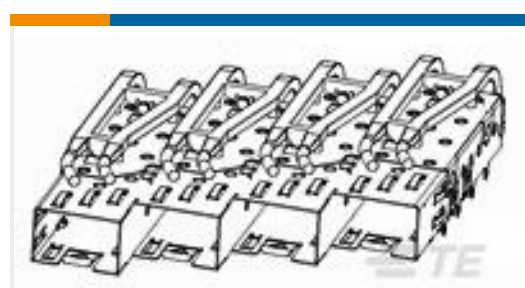

TE Part # 2170166-1
SFP 1X4 ANGLED CAGE & LIGHT PI

Customers Also Bought



TE Part #6-390112-1
SKT, SODIMM, 144P, SDRAM 3.3V, HIGH, T&R



TE Part #1658945-1
XFP CAGE ASSY w/o ELASTOMERIC GASKET



TE Part #1761014-3
SFP 1X2 CAGE ASSY, PRESS FIT



TE Part #5-146278-6
06 MODII HDR SRST B/A .100CL



TE Part #1-1393586-9
V23535A2200A261=BKMOD421 HEADE



TE Part #C95590-000
1330-3300-101TT



TE Part #5176378-2
REC ASS'Y(V) 60P 1.27FHBB



TE Part #139987
PR, SP646 GENERAL PURPOSE 12"

Documents

Product Drawings

[20 POS SMT CONN, SFP, 30AU](#)

English

CAD Files

[3D PDF](#)

3D

Customer View Model

[ENG_CVM_CVM_1367073-2_F3.2d_dxf.zip](#)

English

Customer View Model

[ENG_CVM_CVM_1367073-2_F3.3d_igs.zip](#)

English

Customer View Model

[ENG_CVM_CVM_1367073-2_F3.3d_stp.zip](#)

English

By downloading the CAD file I accept and agree to the [Terms and Conditions](#) of use.

Datasheets & Catalog Pages

[1773408-1 Pluggable Input/Output Solutions catalog - SFP section](#)

English

[4-1773455-4 Quick Reference Guide SFP Solutions](#)

English

Product Specifications

[Application Specification](#)



English

[Application Specification](#)

English

Product Environmental Compliance

[Product Compliance Document](#)

English

[Product Compliance Document](#)

English

Instruction Sheets

[Instruction Sheet \(U.S.\)](#)

English

[Instruction Sheet \(U.S.\)](#)

English