



FocusLCDs.com
LCDs MADE SIMPLE®

Ph. 480-503-4295 | NOPP@FocusLCD.com

TFT | CHARACTER | UWVD | FSC | SEGMENT | CUSTOM | REPLACEMENT

TFT Display Module

Part Number

E70RC-FW850-R

Overview:

- 7.0-inch TFT: (165x100mm)
- 800(RGB)x480 pixels
- 16/18/24-bit RGB Interface
- White LED Backlight
- Top View, Wide Temp
- Transmissive/ Normally White
- 4-wire Resistive Touch Panel
- 850 NITS
- Controller: EK9713/EK7330
- RoHS Compliant

Description

This is a color active matrix TFT (Thin Film Transistor) LCD (Liquid Crystal Display) that uses amorphous silicon TFT as a switching device. This model is composed of a transmissive type TFT-LCD Panel, driver circuit and a backlight unit. The resolution of the 7.0" TFT-LCD contains 800x480 pixels and can display up to 16.7M colors.

TFT Features

Low Input Voltage: 3.3V (TYP)

Display Colors: 65k/262k/16.7M colors

TFT Interfaces: 16/18/24-bit RGB

General Information Items	Specification	Unit	Note
	Main Panel		
TFT Display area (AA)	154.08 (H) x 85.92 (V) (7.0 inch)	mm	-
Driver element	TFT active matrix	-	-
Display colors	65k/262k/16.7M	colors	-
Number of pixels	800(RGB)x480	dots	-
TFT Pixel arrangement	RGB vertical stripe	-	-
Pixel pitch	0.1926 (H) x 0.1790 (V)	mm	-
Viewing angle	12:00	o'clock	-
TFT Controller IC	EK9713/EK7330	-	-
LCM Interface	16/18/24-bit RGB	-	-
Display mode	Transmissive/ Normally White	-	-
Operating temperature	-20~+70	°C	-
Storage temperature	-30~+80	°C	-

Mechanical Information

Item		Min	Typ.	Max	Unit	Note
Module size	Height (H)		165		mm	-
	Vertical (V)		100		mm	-
	Depth (D)		7.3		mm	-
Weight			TBD		g	-

1. Block Diagram

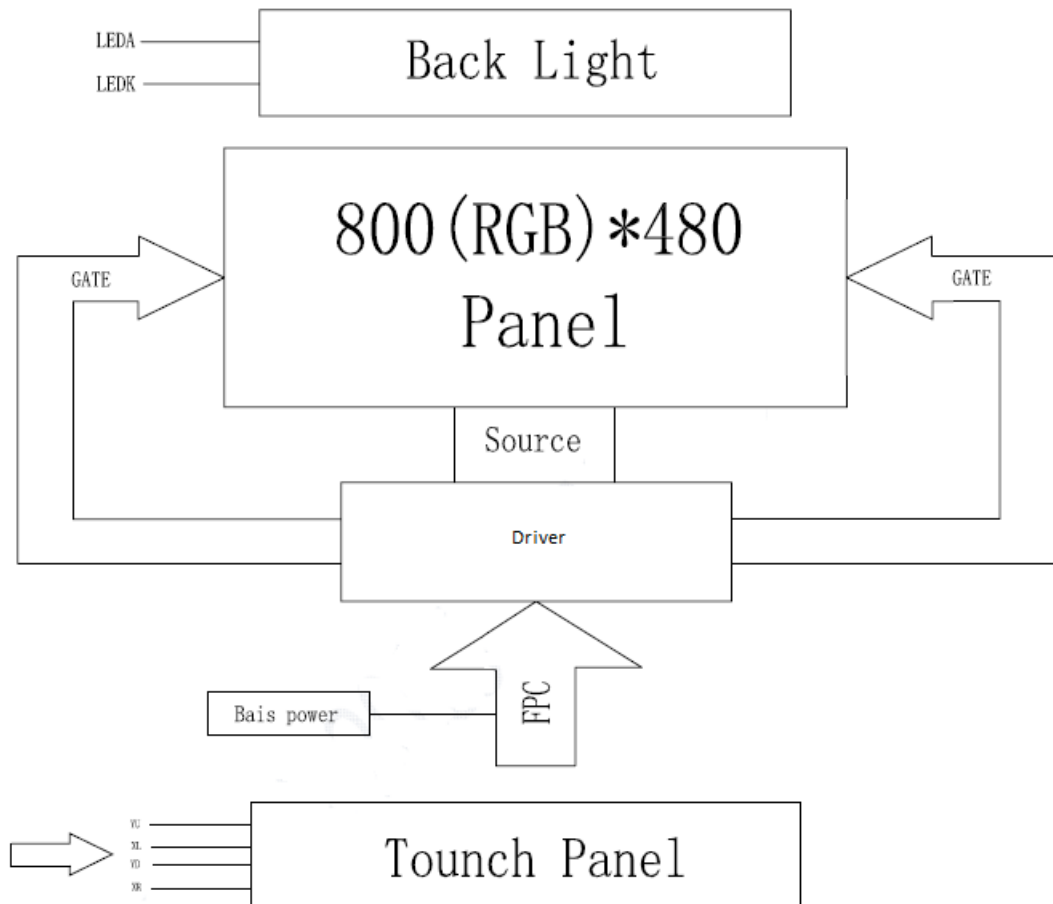

2. Outline Dimensions

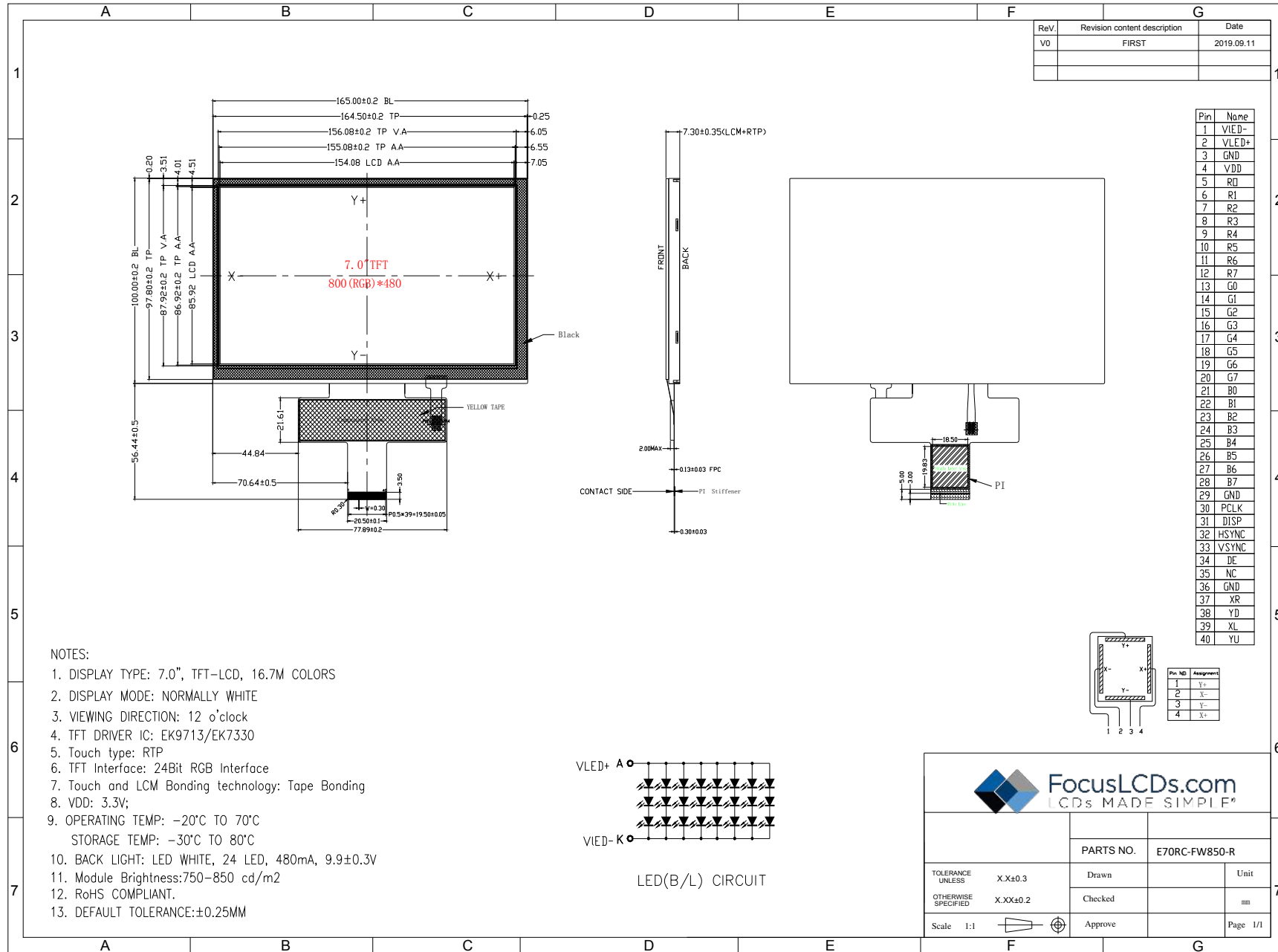

3. Input Terminal Pin Assignment

Recommended TFT Connector: FH12S-40S-0.5SH(55)

Recommended RTP Connector: FH33-4S-1SH(10)

NO.	Symbol	Description	I/O
1	VLED-	Cathode pin of the backlight	P
2	VLED+	Anode pin of the backlight	P
3	GND	Ground	P
4	VDD	Supply voltage (3.3V)	P
5	R0	Red data input	I/O
6	R1	Red data input	I/O
7	R2	Red data input	I/O
8	R3	Red data input	I/O
9	R4	Red data input	I/O
10	R5	Red data input	I/O
11	R6	Red data input	I/O
12	R7	Red data input	I/O
13	G0	Green data input	I/O
14	G1	Green data input	I/O
15	G2	Green data input	I/O
16	G3	Green data input	I/O
17	G4	Green data input	I/O
18	G5	Green data input	I/O
19	G6	Green data input	I/O
20	G7	Green data input	I/O
21	B0	Blue data input	I/O
22	B1	Blue data input	I/O
23	B2	Blue data input	I/O
24	B3	Blue data input	I/O
25	B4	Blue data input	I/O
26	B5	Blue data input	I/O
27	B6	Blue data input	I/O
28	B7	Blue data input	I/O
29	GND	Ground	p
30	PCLK	Dot clock signal for RGB interface operation	I
31	DISP	Standby setting for testing. Connect to VDDIO in normal operation mode. If connected to GND the IC is in standby mode.	I
32	HSYNC	Line synchronizing signal for RGB interface operation	I
33	VSYNC	Frame synchronizing signal for RGB interface operation	I
34	DE	Data enable signal for RGB interface operation	I
35	NC	NC	
36	GND	Ground	P
37	XR	Touch panel right glass terminal	A/D
38	YD	Touch panel bottom film terminal	A/D
39	XL	Touch panel left glass terminal	A/D
40	YU	Touch panel top film terminal	A/D

4. LCD Optical Characteristics

4.1 Optical Specifications

Item	Symbol	Condition	Min	Typ.	Max	Unit	Note	
Contrast Ratio	CR	θ=0 Normal viewing angle	400	500	--	%	(2)	
Response Time	Rising		TR	--	10	20	ms	(4)
	Falling		TF	--	15	30	ms	(4)
Color Gamut	S(%)		50	60	--	%	(5)	
Color Filter Chromaticity	White		W _x	0.262	0.302	0.342		(5)(6)
			W _y	0.246	0.316	0.356		
	Red		R _x	0.584	0.624	0.664		
			R _y	0.291	0.331	0.371		
	Green		G _x	0.256	0.296	0.336		
			G _y	0.537	0.577	0.617		
	Blue	B _x	0.103	0.143	0.183			
		B _y	0.069	0.109	0.149			
Viewing Angle	Hor.	Θ _L	--	70	--	degree	(1)(6)	
		Θ _R	--	70	--			
	Ver.	Θ _T	--	50	--			
		Θ _B	--	70	--			
Option View Direction	12:00						(1)	

Optical Specification Reference Notes:

(1) Definition of Viewing Angle: The viewing angle is the angle at which the contrast ratio is greater than 10. The viewing angles are determined for the horizontal or 3,9 o'clock direction and the vertical or 6,12 o'clock direction with respect to the optical axis which is normal to the LCD surface.

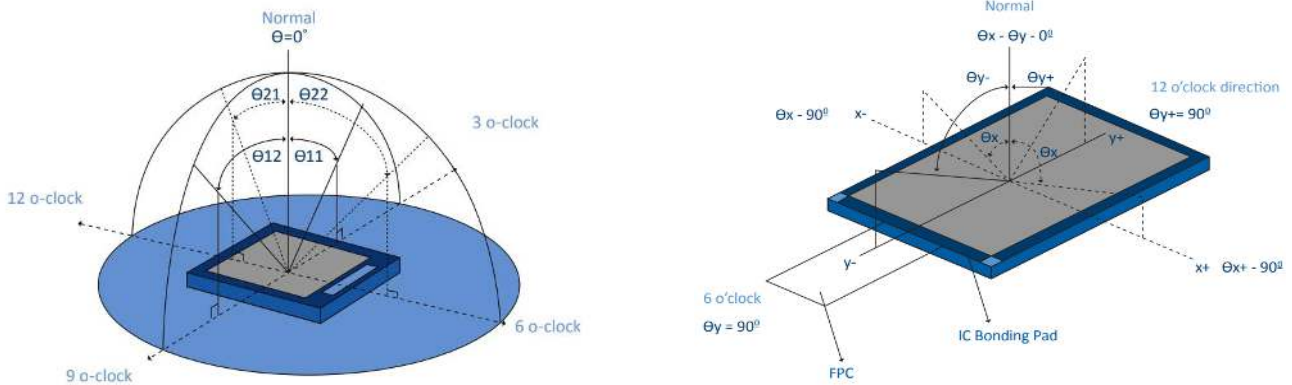

(2) Definition of Contrast Ratio (Cr): measured at the center point of panel. The contrast ratio (Cr) measured on a module, is the ratio between the luminance (Lw) in a full white area (R=G=B=1) and the luminance (Ld) in a dark area (R=G=B=0).

$$Cr = \frac{Lw}{Ld}$$

(3) Definition of transmittance (T%): The transmittance of the panel including the polarizers is measured with electrical driving. The equation for transmittance Tr is:

$$Tr = \frac{It}{Io} \times 100\%$$

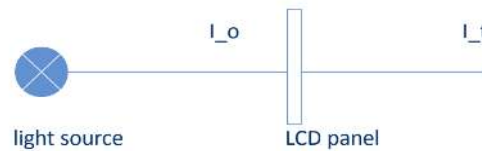

I_o = the brightness of the light source.
 I_t = the brightness after panel transmission

(4) Definition of Response Time (T_r , T_f): The rise time ' T_r ' is defined as the time for luminance to change from 90% to 10% as a result of a change of the electrical condition. The fall time ' T_f ' is defined as the time for luminance to change from 10% to 90% as a result of a change of the electrical condition.

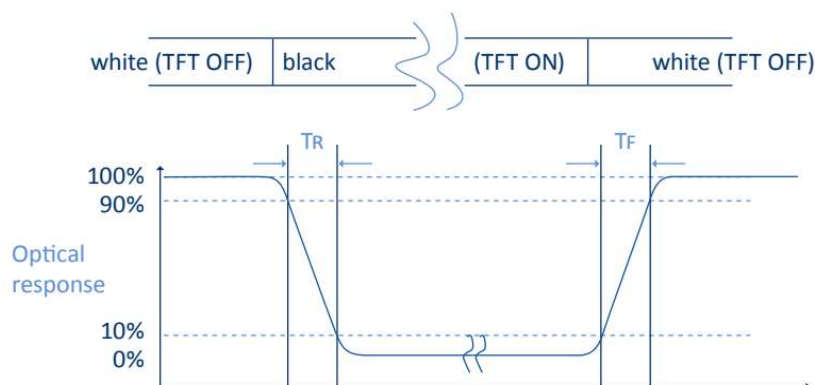

(5) Definition of Color Gamut:

Measuring machine CFT-01. NTSC's Primaries: $R(x,y,Y), G(x,y,Y), B(x,y,Y)$. FPM520 of Westar Display Technologies, INC., which utilized SR-3 for Chromaticity and BM-5A for other optical characteristics. The color chromaticity shall be calculated from the spectral data measured with all pixels first in red, green, blue and white. Measurements shall be made at the center of the panel.

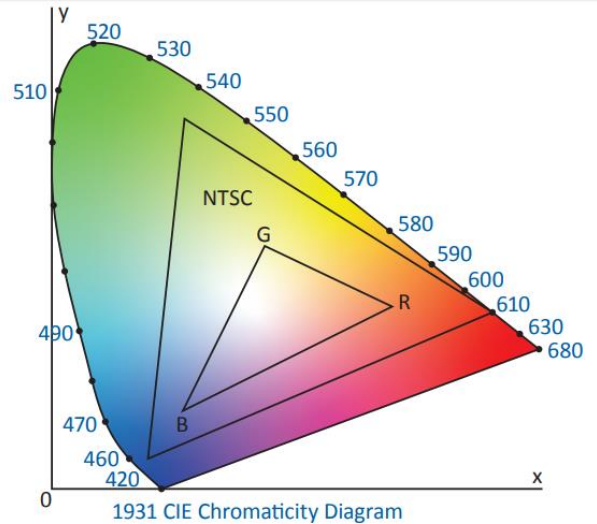
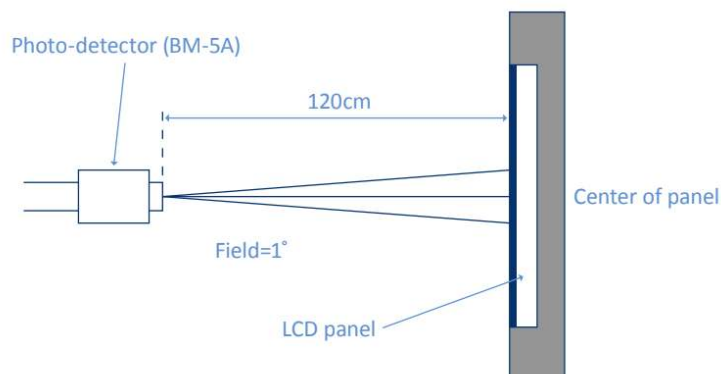
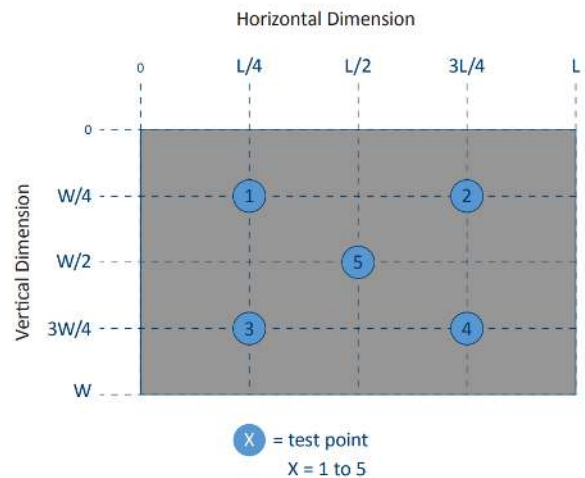
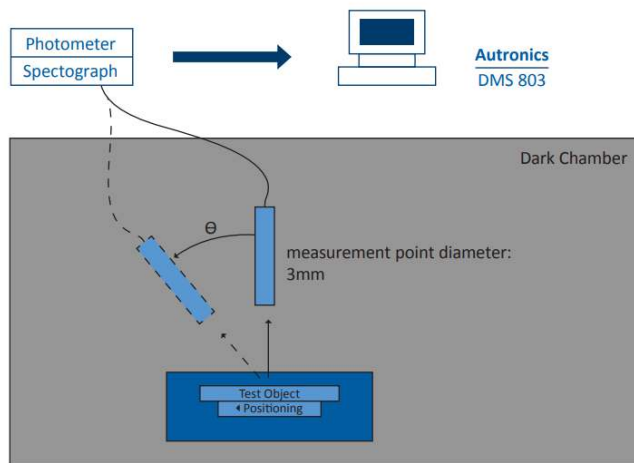

Fig. 1931 CIE chromacity diagram

$$\text{Color gamut: } S = \frac{\text{Area of RGB triangle}}{\text{Area of NTSC triangle}} \times 100\%$$

(6) Definition of Optical Measurement Setup:

The LCD module should be stabilized at a given temperature for 20 minutes to avoid abrupt temperature change during measuring. In order to stabilize the luminance, the measurement should be executed after lighting backlight for 20 minutes.



5. TFT Electrical Characteristics

5.1 Absolute Maximum Rating (Ta=25 °C, VSS=0V)

Characteristics	Symbol	Min	Max	Unit
Digital Supply Voltage	VDD	-0.5	5.0	V
Operating Temperature	TOP	-20	+70	°C
Storage Temperature	TST	-30	+80	°C

NOTE: If the absolute maximum rating of the above parameters is exceeded, even momentarily, the quality of the product may be degraded. Absolute maximum ratings specify the values which the product may be physically damaged if exceeded. Be sure to use the product within the range of the absolute maximum ratings.

5.2 DC Electrical Characteristics

Characteristics	Symbol	Min	Typ.	Max	Unit	Note
Digital Supply Voltage	VDD	3.0	3.3	3.6	V	
Normal Mode Current Consumption	IDD	--	150	300	mA	
Level Input Voltage	VIH	0.7VDD	--	VDD	V	
	VIL	GND	--	0.3VDD	V	
Level Output Voltage	VOH	0.8VDD	--	VDD	V	
	VOL	GND	--	0.2VDD	V	

5.3 LED Backlight Characteristics

The backlight system is edge lighting type with 24 white LEDs.

Item	Symbol	Min	Typ.	Max	Unit	Note
Forward Current	I _F	460	280	--	mA	
Forward Voltage	V _F	9.3	9.9	10.5	V	
LCM Luminance	LV	750	850	--	cd/m ²	Note 3
LED lifetime	Hr	50000	--	--	hour	Note1 & 2
Uniformity	AV _g	80	--	--	%	Note 3

Note 1: LED lifetime (Hr) can be defined as the time in which it continues to operate under the condition: T_a=25 ±3 °C, typical IL value indicated in the above table until the brightness becomes less than 50%.

Note 2: The “LED lifetime” is defined as the module brightness decrease to 50% original brightness at T_a=25°C and I_L = 480mA. The LED lifetime could be decreased if operating I_L is larger than 480mA. The constant current driving method is suggested.

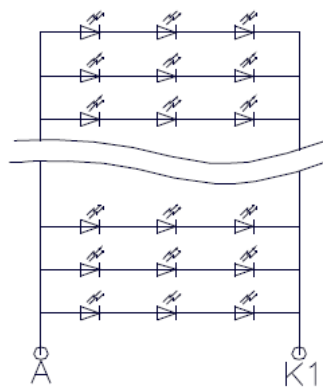

Note 3: Luminance Uniformity of these 9 points is defined as below:

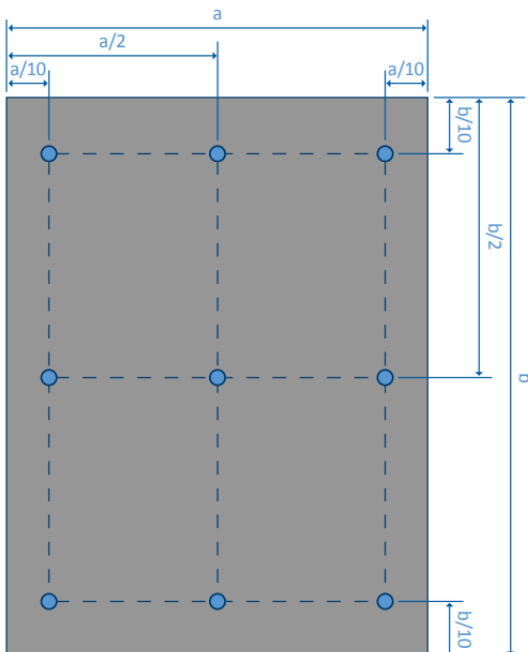

$$\text{Luminance} = \frac{\text{(Total Luminance of 9 points)}}{9}$$

$$\text{Uniformity} = \frac{\text{minimum luminance in 9 points(1-9)}}{\text{maximum luminance in 9 points(1-9)}}$$

6. TP Feature

6.1 Conditions of Use and Storage

Item	Condition	Note
Temperature range upon operation	Humidity: 20%-90% non-dew, condensation -20°C~70°C	In a simple substance
Temperature range upon storage	Humidity: 20%-90% non-dew, condensation -30°C~80°C	In a simple substance

6.2 Electrical Property

Item	Value	Note
Maximum voltage	DC5V	
Resistance between terminal	X direction (film side): 200-600 Ω	
	Y direction (glass side): 300-900 Ω	
Insulation resistance	DC 25V, 20M Ω or above	Connect X + ~X and Y+ ~Y, apply 25VDC Between X and Y for perform measurements
Chattering	10ms or below	
Rating	Voltage is 5V DC	

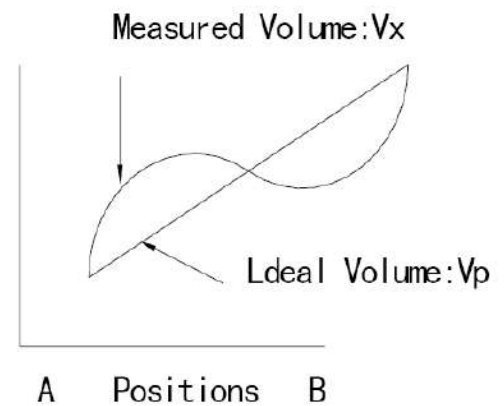
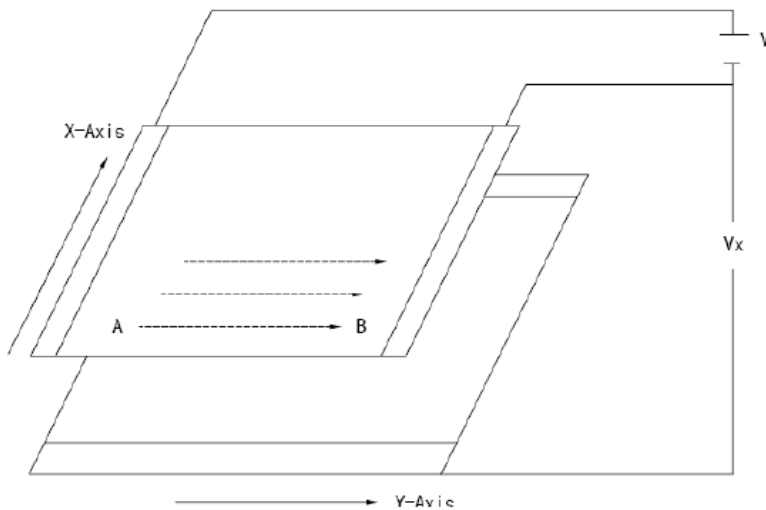

6.3 Mechanical Property

Item	Value		Note
Input method	Used of an exclusive pen or finger		
Load upon operation	Exclusive pen	60-100g or below	Operation and measurement with a pen must be carried out under the following tip conditions: Stylus pen material: POM (polyacetal) Tip: Diameter 3.0mm, SR 0.8 mm
	Finger	60-100g or below	Operation and measurement with a pen must be carried out under the following tip conditions: Stylus pen material: Silicon rubber (Hardness: 30°Hs) Tip: Diameter 12.0mm, SR 12.5 mm
Surface hardness	Pencil Hardness: 3H or above		It complies with the way of test method JIS K5400

6.4 Optical Property

Item	Performance	Note
Total light transmittance	80% or above	JIS K7105
Haze	5% or below	JIS K7136
Film specification	Polished type with hard coated surface	

7. Signal Timing Specifications

7.1 AC Electrical Characteristics

Parameter	Symbol	Min	Typ.	Max	Unit	Note
HS setup time	Thst	8	-	-	ns	
HS hold time	Thhd	8	-	-	ns	
VS setup time	Tvst	8	-	-	ns	
VS hold time	Tvhd	8	-	-	ns	
Data setup time	Tdsu	8	-	-	ns	
Data hold time	Tdhd	8	-	-	ns	
DE setup time	Tesu	8	-	-	ns	
DE hold time	Tehd	8	-	-	ns	
DVDD Power on slew rate	Tpor	-	-	20	ms	From 0 to 90% DVDD
Reset pulse width	Trst	1	-	-	ms	
DCLK cycle time	Tcoh	20	-	-	ns	
DCLK pulse duty	Tcwh	40	50	50	%	

7.2 Data Input Format



Horizontal Input Timing Diagram

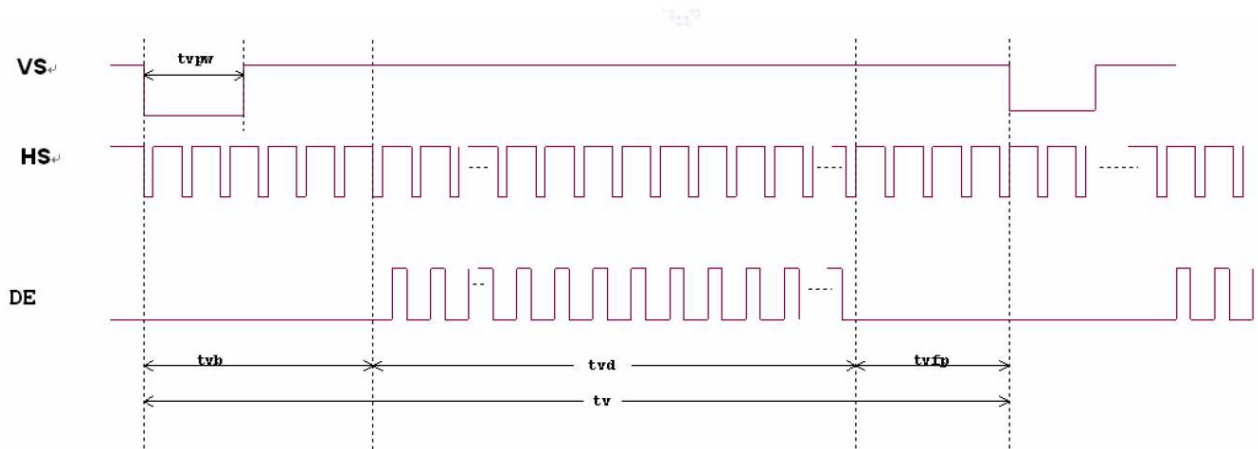

Vertical Input Timing Diagram

7.3 Timing Characteristics

Parameter	Symbol	Min	Typ.	Max	Unit	Note
Horizontal Display Area	thd	-	800	-	DCLK	
DCLK Frequency	fclk	26.4	33.3	46.8	MHz	
One Horizontal Line	th	862	1056	1200	DCLK	
HS Pulse Width	thpw	1	-	40	DCLK	
HS Blanking	thb	46	46	46	DCLK	
HS Front Porch	thfp	16	210	354	DCLK	

Parameter	Symbol	Min	Typ.	Max	Unit	Note
Vertical Display Area	tvd	-	480	-	TH	
VS Period Time	tv	510	525	650	TH	
VS Pulse Width	tvpw	1	-	20	TH	
VS Blanking	tvb	23	23	23	TH	
VS Front Porch	tvfp	7	22	147	TH	

8. Cautions and Handling Precautions

8.1 Handling and Operating the Module

1. When the module is assembled, it should be attached to the system firmly. Do not warp or twist the module during assembly work.
2. Protect the module from physical shock or any force. In addition to damage, this may cause improper operation or damage to the module and back-light unit.
3. Note that polarizer is very fragile and could be easily damaged. Do not press or scratch the surface.
4. Do not allow drops of water or chemicals to remain on the display surface. If you have the droplets for a long time, staining and discoloration may occur.
5. If the surface of the polarizer is dirty, clean it using some absorbent cotton or soft cloth.
6. The desirable cleaners are water, IPA (Isopropyl Alcohol) or Hexane. Do not use ketene type materials (ex. Acetone), Ethyl alcohol, Toluene, Ethyl acid or Methyl chloride. It might permanent damage to the polarizer due to chemical reaction.
7. If the liquid crystal material leaks from the panel, it should be kept away from the eyes or mouth. In case of contact with hands, legs, or clothes, it must be washed away thoroughly with soap.
8. Protect the module from static; it may cause damage to the CMOS ICs.
9. Use fingerstalls with soft gloves in order to keep display clean during the incoming inspection and assembly process.
10. Do not disassemble the module.
11. Protection film for polarizer on the module shall be slowly peeled off just before use so that the electrostatic charge can be minimized.
12. Pins of I/F connector shall not be touched directly with bare hands.
13. Do not connect, disconnect the module in the "Power ON" condition.
14. Power supply should always be turned on/off by the item Power On Sequence & Power Off Sequence

8.2 Storage and Transportation.

1. Do not leave the panel in high temperature, and high humidity for a long time. It is highly recommended to store the module with temperature from 0 to 35 °C and relative humidity of less than 70%
2. Do not store the TFT-LCD module in direct sunlight.
3. The module shall be stored in a dark place. When storing the modules for a long time, be sure to adopt effective measures for protecting the modules from strong ultraviolet radiation, sunlight, or fluorescent light.
4. It is recommended that the modules should be stored under a condition where no condensation is allowed. Formation of dewdrops may cause an abnormal operation or a failure of the module. In particular, the greatest possible care should be taken to prevent any module from being operated where condensation has occurred inside.
5. This panel has its circuitry FPC on the bottom side and should be handled carefully in order not to be stressed.