

Main Product Characteristics

$V_{(BR)DSS}$	40V
$R_{DS(ON)}$	9m Ω
I_D	30A

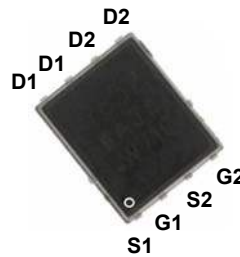

PPAK5x6

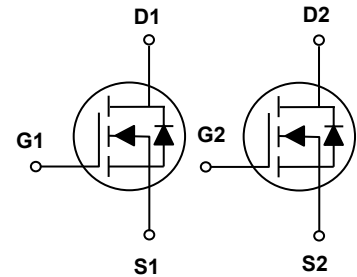

Schematic Diagram

Features and Benefits

- Advanced MOSFET process technology
- Ideal for high efficiency switched mode power supplies
- Low on-resistance with low gate charge
- Fast switching and reverse body recovery



Description

The SSFP4806 utilizes the latest techniques to achieve high cell density and low on-resistance. These features make this device extremely efficient and reliable for use in high efficiency switch mode power supply and a wide variety of other applications.

Absolute Maximum Ratings ($T_C=25^\circ\text{C}$ unless otherwise specified)

Parameter	Symbol	Max.	Unit
Drain-Source Voltage	V_{DS}	40	V
Gate-Source Voltage	V_{GS}	± 20	V
Drain Current-Continuous ($T_C=25^\circ\text{C}$)	I_D	30	A
Drain Current-Continuous ($T_C=100^\circ\text{C}$)		19	
Drain Current-Pulsed ¹	I_{DM}	120	A
Single Pulse Avalanche Energy ²	E_{AS}	64	mJ
Single Pulse Avalanche Current ²	I_{AS}	36	A
Power Dissipation ($T_C=25^\circ\text{C}$)	P_D	46	W
Power Dissipation-Derate above 25°C		0.37	
Thermal Resistance, Junction-to-Ambient	$R_{\theta JA}$	62	$^\circ\text{C}/\text{W}$
Thermal Resistance, Junction-to-Case	$R_{\theta JC}$	2.7	$^\circ\text{C}/\text{W}$
Operating Junction Temperature Range	T_J	-55 To +150	$^\circ\text{C}$
Storage Temperature Range	T_{STG}	-55 To +150	$^\circ\text{C}$

Electrical Characteristics ($T_J=25^{\circ}\text{C}$ unless otherwise specified)

Parameter	Symbol	Conditions	Min.	Typ.	Max.	Unit
On/Off Characteristics						
Drain-Source Breakdown Voltage	BV_{DSS}	$V_{GS}=0V, I_D=250\mu A$	40	-	-	V
Drain-Source Leakage Current	I_{DSS}	$V_{DS}=40V, V_{GS}=0V, T_J=25^{\circ}\text{C}$	-	-	1	μA
		$V_{DS}=32V, V_{GS}=0V, T_J=125^{\circ}\text{C}$	-	-	10	μA
Gate-Source Leakage Current	I_{GSS}	$V_{GS}=\pm 20V, V_{DS}=0V$	-	-	± 100	nA
Static Drain-Source On-Resistance ³	$R_{DS(ON)}$	$V_{GS}=10V, I_D=8A$	-	7.2	9	m Ω
		$V_{GS}=4.5V, I_D=4A$	-	9.5	12	
Gate Threshold Voltage	$V_{GS(th)}$	$V_{GS}=V_{DS}, I_D=250\mu A$	1	1.6	2.5	V
Forward Transconductance	g_{fs}	$V_{DS}=10V, I_D=10A$	-	13	-	S
Dynamic and Switching Characteristics						
Total Gate Charge ^{3,4}	Q_g	$V_{DS}=20V, I_D=8A, V_{GS}=4.5V$	-	12.2	24	nC
Gate-Source Charge ^{3,4}	Q_{gs}		-	3.3	7	
Gate-Drain Charge ^{3,4}	Q_{gd}		-	6.7	13	
Turn-On Delay Time ^{3,4}	$t_{d(on)}$	$V_{DD}=15V, R_G=3.3\Omega, V_{GS}=10V, I_D=1A$	-	13.2	25	nS
Rise Time ^{3,4}	t_r		-	2.2	5	
Turn-Off Delay Time ^{3,4}	$t_{d(off)}$		-	72	130	
Fall Time ^{3,4}	t_f		-	4.5	10	
Input Capacitance	C_{iss}	$V_{DS}=25V, V_{GS}=0V, F=1\text{MHz}$	-	1220	2200	pF
Output Capacitance	C_{oss}		-	130	250	
Reverse Transfer Capacitance	C_{rss}		-	55	110	
Gate Resistance	R_g	$V_{GS}=0V, V_{DS}=0V, F=1\text{MHz}$	-	2.2	-	Ω
Guaranteed Avalanche Energy						
Single Pulse Avalanche Energy	E_{AS}	$V_{DD}=25V, L=0.1\text{mH}, I_{AS}=6A$	1.8	-	-	mJ
Drain-Source Diode Characteristics and Maximum Ratings						
Continuous Source Current	I_S	$V_G=V_D=0V, \text{Force Current}$	-	-	30	A
Pulsed Source Current ³	I_{SM}		-	-	60	A
Diode Forward Voltage ³	V_{SD}	$V_{GS}=0V, I_S=1A, T_J=25^{\circ}\text{C}$	-	-	1	V

Note:

1. Repetitive rating: Pulsed width limited by maximum junction temperature.
2. $V_{DD}=25V, V_{GS}=10V, L=0.1\text{mH}, I_{AS}=36A, R_G=25\Omega, \text{starting } T_J=25^{\circ}\text{C}$.
3. Pulse test: pulse width $\leq 300\mu s, \text{duty cycle} \leq 2\%$.
4. Essentially independent of operation temperature.

Typical Electrical and Thermal Characteristic Curves

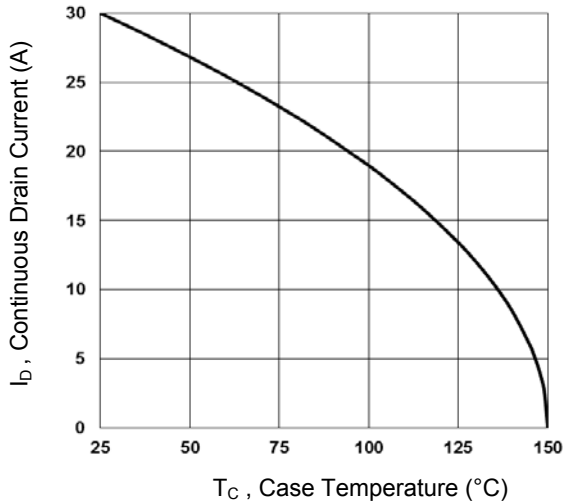

Figure 1. Continuous Drain Current vs. T_C

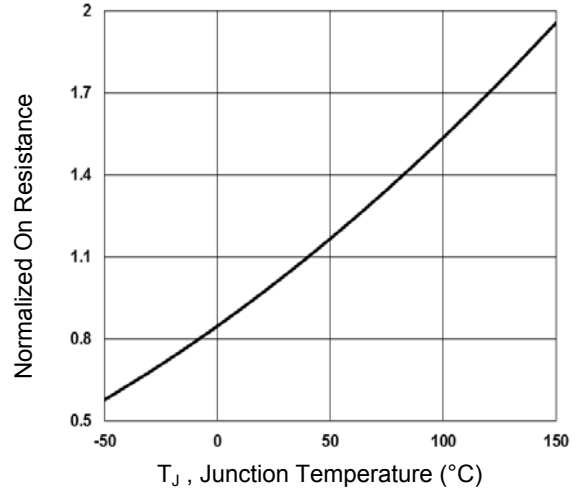

Figure 2. Normalized $R_{DS(ON)}$ vs. T_J

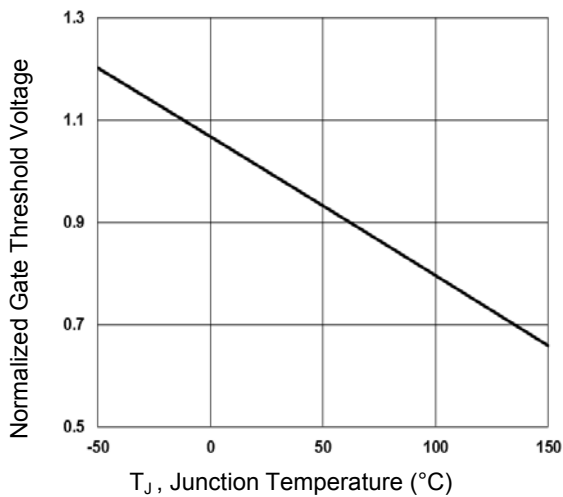

Figure 3. Normalized V_{th} vs. T_J

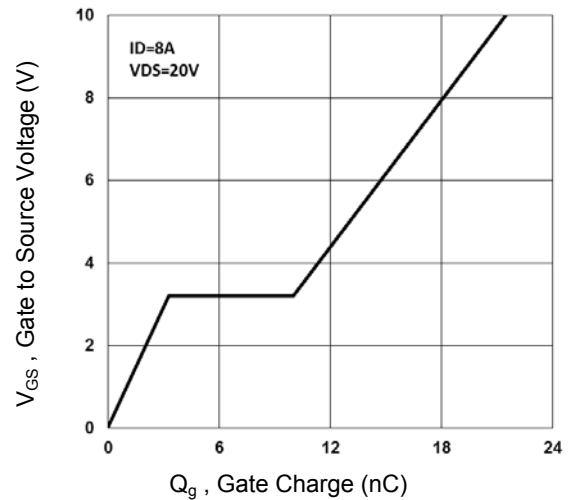

Figure 4. Gate Charge Waveform

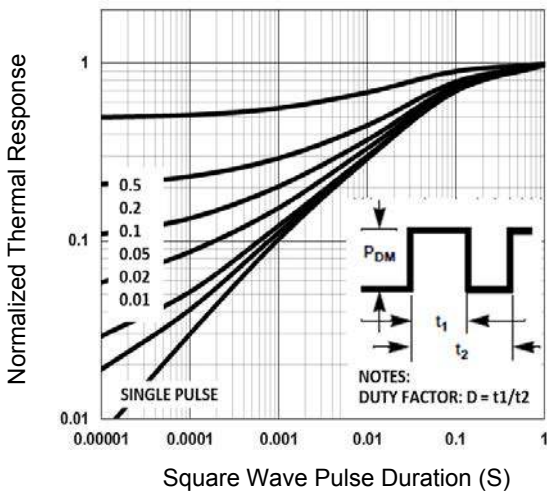

Figure 5. Normalized Transient Impedance

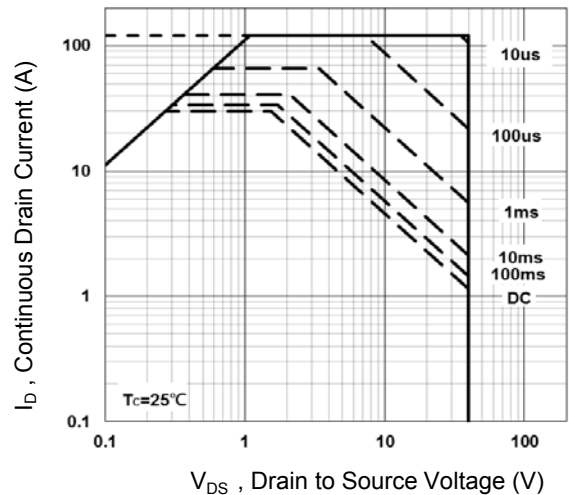

Figure 6. Maximum Safe Operation Area

Typical Electrical and Thermal Characteristic Curves

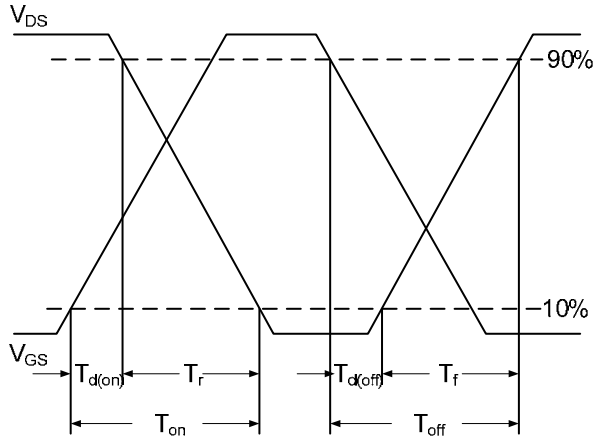

Figure 7. Switching Time Waveform

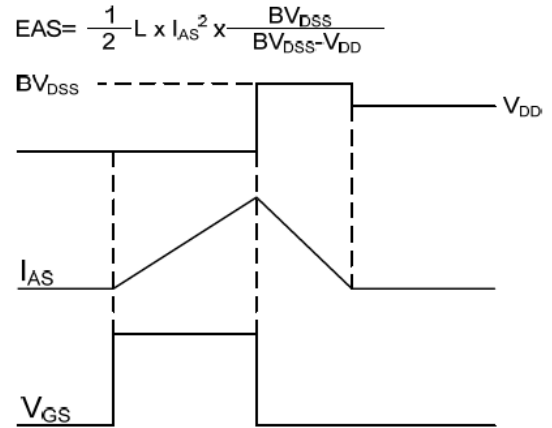
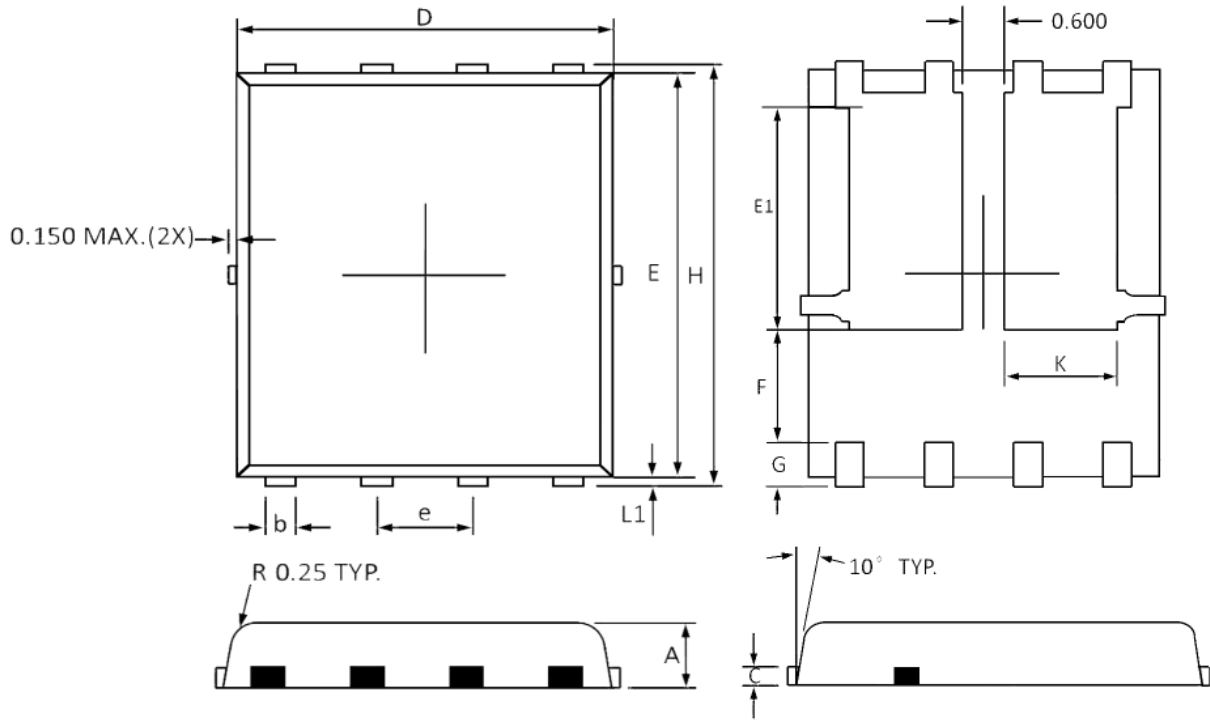

Figure 8. EAS Waveform

Package Outline Dimensions

PPAK5x6



Symbol	Dimensions In Millimeters		Dimensions In Inches	
	Min	Max	Min	Max
A	0.800	1.200	0.031	0.047
b	0.300	0.510	0.012	0.020
C	0.250 Ref		0.010 Ref	
D	4.800	5.400	0.189	0.213
E	5.450	5.960	0.215	0.235
E1	3.200	3.800	0.126	0.150
e	1.27 BSC		0.050 BSC	
F	1.000	1.900	0.039	0.075
G	0.380	0.800	0.015	0.031
H	5.850	6.300	0.230	0.248
L1	0.050	0.250	0.002	0.010
K	1.500	1.900	0.059	0.074

Recommended Pad Layout

