

48 x 48 Digital LCD Timer 814 Part number 88857105



Relay output digital timers

- Multi-range
- Multi-voltage
- 1 or 2 relay outputs
- Data saved in the event of a break in supply (Timer 815)
- Access to programming lockable (Timer 814, 815)
- Up or down timing mode
- Internal power supply by battery (10 years / 20 °C)

Part numbers

Type	Functions	Connection	Relay outputs	Supply voltage	Nominal rating	
88857105	Timer 814	A, B, C, D, Di, H	Plug-in 11 way	1 timed changeover	24 V ACDC / 110 →240 V AC	8 A

Specifications

Number of digits	4
Height of digits	TIMER 812 - 814 - 815 : 8 mm
Timing ranges	99,99 s 999,9 s 9999 s 99 min 59 s 99,99 min 999,9 min 9999 min 99 h 59 min 99,99 h 999,9 h 9999 h
Repetition accuracy (with constant parameters)	TIMER 812 - 814 - 815 : $\pm 0,03 \% \pm 20$ ms
Display precision	TIMER 812 - 814 - 815 : $\pm 0,03 \% \pm 20$ ms
Min. control pulse	50 ms
Maximum reset time by de-energisation during timed delay	50 ms
Maximum reset time by de-energisation after timing	50 ms
Nominal rating	TIMER 814 - 815 : 8 A AC 8 A DC TIMER 812 : 5 A AC 5 A DC
Max. breaking voltage	TIMER 812 - 814 - 815 : 250 V AC 30 V
Maximum power rating (resistive)	TIMER 814 - 815 : 2000 VA - 190 W TIMER 812 : 1250 VA - 120 W
Maximum admissible current	15 A < 0,01 s
Minimum current	TIMER 812 - 814 - 815 : 250 V AC 30 V DC 100 mA
Electrical life at I max., 250 V AC resistive (cycles)	10^5
Max. permitted number of operations at 1 max 250 V AC resistive per hour	600
Mechanical life (operations)	TIMER 812 - 814 - 815 : 5×10^6
Voltage variation	TIMER 814 : + 10 % - 15 %
Immunity from micro power cuts	< 0,03 s
Max. absorbed power	0.5 W / 12 V 1 VA / 24 V 0.5 W / 24 V 3.5 VA / 110 V 1 W / 48 V 11 VA / 220 V
Temperature limits use (°C)	TIMER 812 - 814 - 815 : -10 °C →+60 °C
Temperature limits stored (°C)	TIMER 812 - 814 - 815 : -30 °C →+70 °C
Degree of protection front face	TIMER 812 - 814 - 815 : IP65
Insulation according to standard IEC/EN 61812-1, IEC/EN 60255-5	EN61812-1 - IEC255-5
Protection class according to CEI/EN 60529	■
Mounting Front panel, by clip	■
Mounting base-mounted on socket	■
Material	Self-extinguishing UL 94 grade V0
Weight (g)	TIMER 814 : 100 TIMER 812 - 815 : 140

Accessories

Accessories	Code
8-pin solder-connected plug	25622301
11-pin solder-connected plug	25622076

Spring clips (pack of 2)	79237739
11-pin connector base	25622080
8-pin connector base	25622130
11-pole rear base	79694002

Dimensions (mm)

Timer 812 - 814 - 815

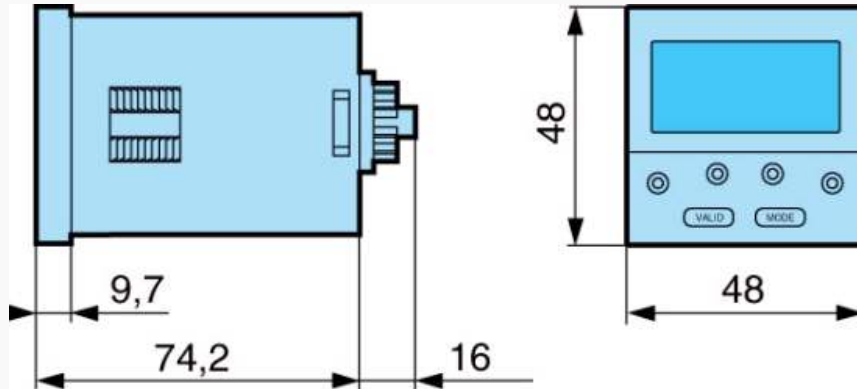

Dimensions (mm)

Panel cut-out

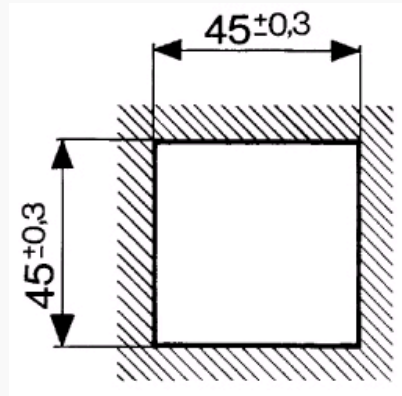

Dimensions (mm)

11-pole rear base

79694002

Panel-mounted

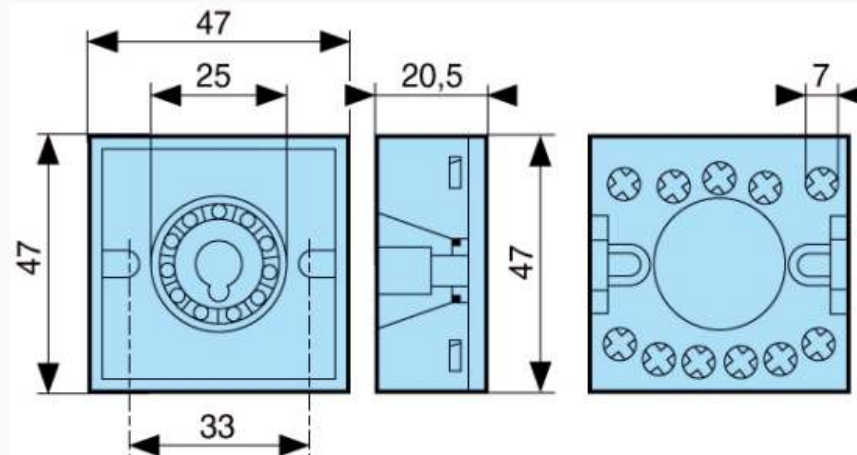

Dimensions (mm)

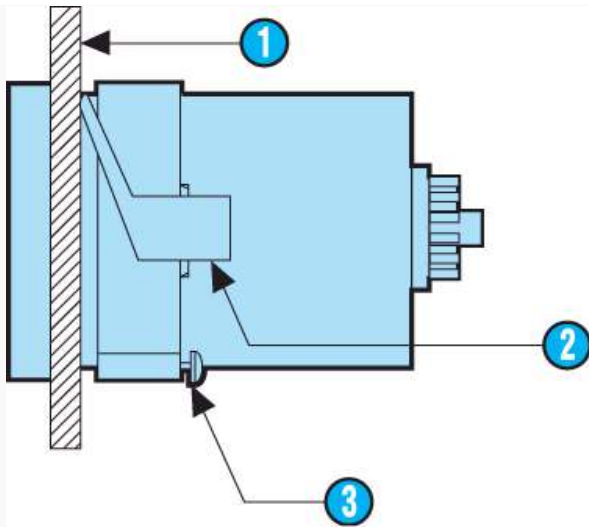

N°	Legend
1	Panel thickness 1 to 3,5 mm
2	Clip for panel-mounting
3	Positioning screw

Dimensions (mm)

8-pin or 11-pin solder-connected plug
25 622 076 - 25 622 301

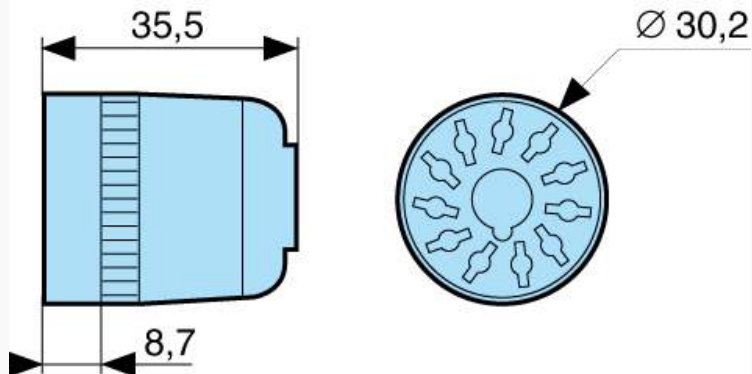

Dimensions (mm)

Connector socket
11-pin 25622080
8-pin 25622130

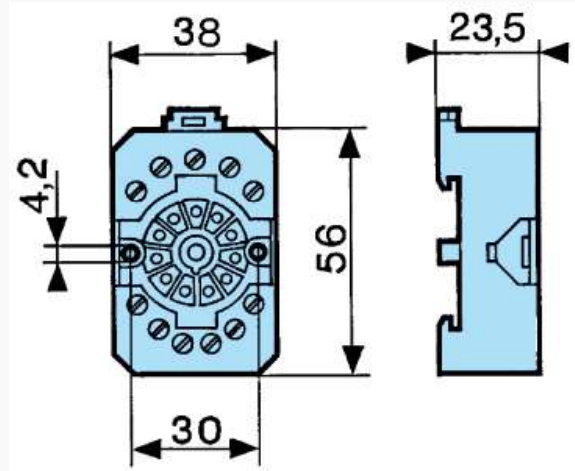

Curves

Function A

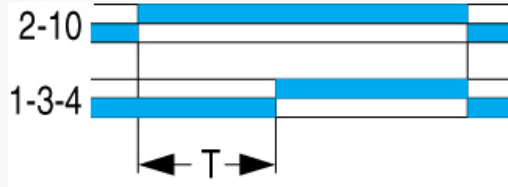

Function A

Delay on energisation
1 timed relay

Curves

Function B

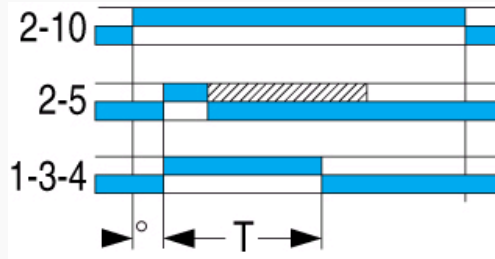

Function B

Timing on impulse (one shot)

Curves

Function C

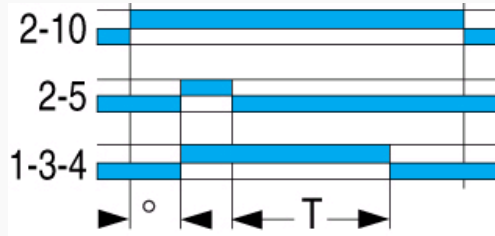

Function C

Timing after impulse (delay off)

Curves

Function D

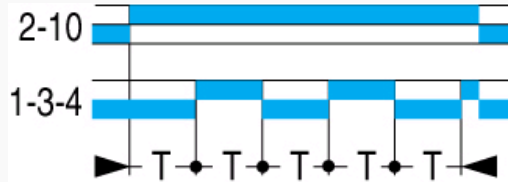

Function D

Flip-flop

Curves

Function Di

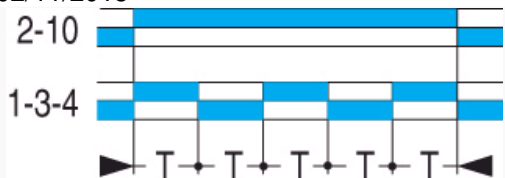

Function Di
Flip-flop

Curves

Function H

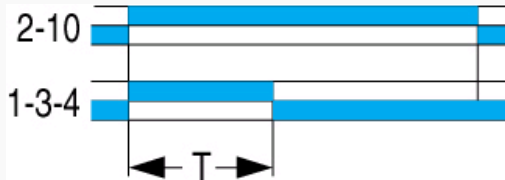

Function H
Timing or energisation

Connections

Timer 814 - 11-pin

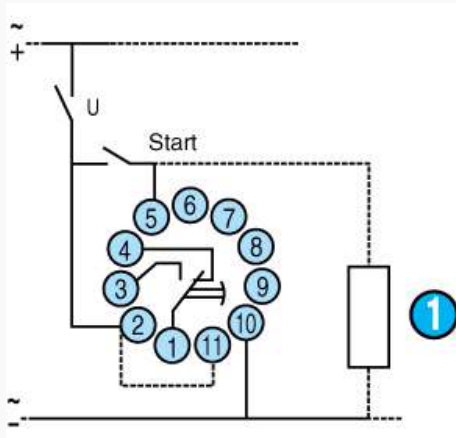

N°	Legend
①	Other loads may be connected in parallel

Connections

Timer 814 - 8-pin

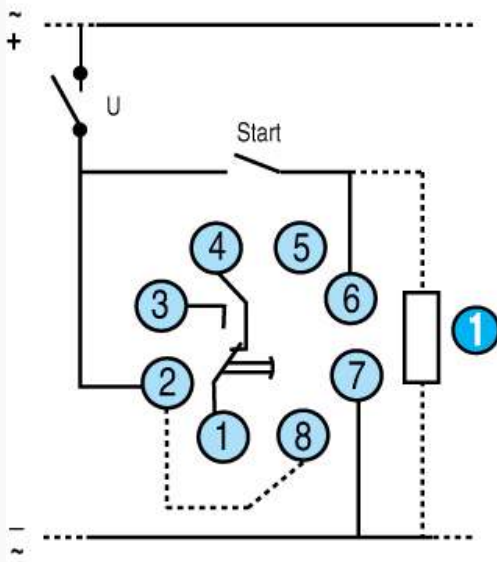

N°	Legend
1	Other loads may be connected in parallel

Connections

Timer 814 - 11-pin

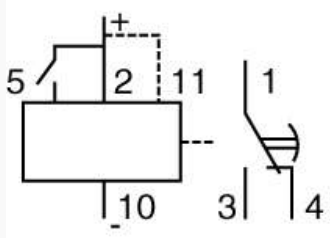

N°	Legend
2-10	Supply
(2-11)	Bridge (88 857 003-88 857 005)
2-5	Control contact or reset
1-3-4	Timed output contact

Connections

Timer 814 - 8-pin

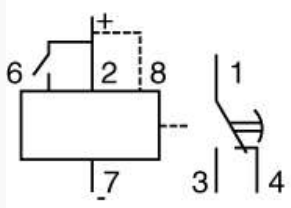

N°	Legend
2-7	Supply
(2-8)	Bridge (88 857 103-88 857 105)
2-6	Control contact reset
1-3-4	Timed output contact

Connections

CA 88857003

CA 88857003