

## GABRIELLA-45-W

~35° wide beam with holder

### SPECIFICATION:

Dimensions	Ø 45.0 mm
Height	28.8 mm
Fastening	pin, screw
ROHS compliant	yes ⓘ

### MATERIALS:

Component	Type	Material	Colour	Finish
C15813_GABRIELLA-45-W	Single lens	PMMA	clear	
C15528_GABRIELLA-45-HLD	Holder	PC	black	

### ORDERING INFORMATION:

#### Quantities for one set:

Single lens	1
Holder	1



Component		Qty in box	MOQ	MPQ	Box weight (kg)
C15813_GABRIELLA-45-W	Single lens	405	90	45	8.6
» Box size: 476 x 273 x 292 mm					
C15528_GABRIELLA-45-HLD	Holder	405	90	45	5.1
» Box size: 476 x 273 x 292 mm					

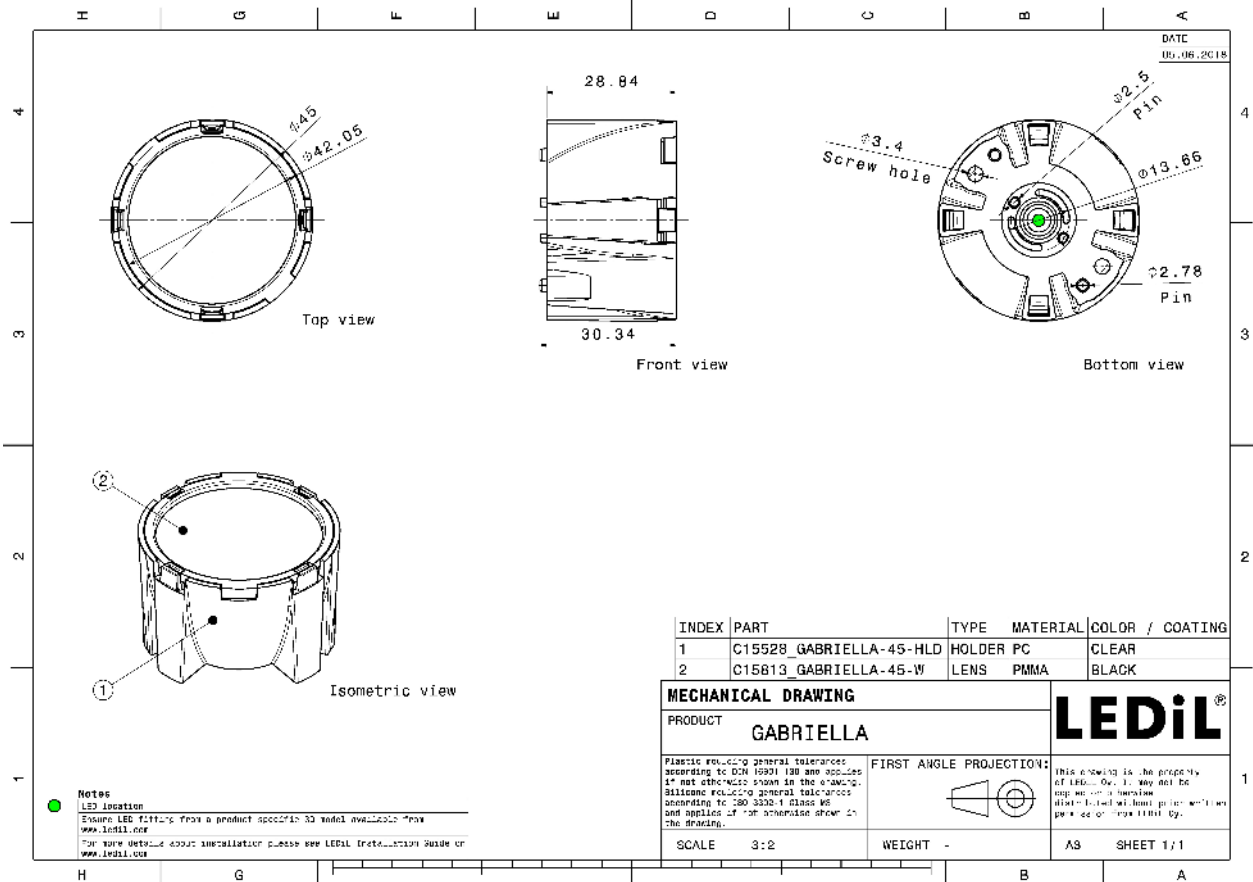

See also our general installation guide: [www.ledil.com/installation\\_guide](http://www.ledil.com/installation_guide)

### OPTICAL RESULTS (MEASURED):

#### CREE LED

LED XM-L RGBW (XMLCTW)  
 FWHM / FWTM 37.0° / 62.0°  
 Efficiency 79 %  
 Peak intensity 1.8 cd/m  
 LEDs/each optic 1  
 Light colour White  
 Required components:

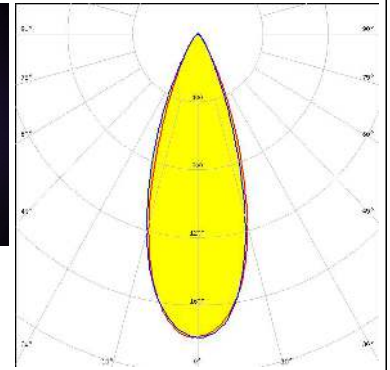
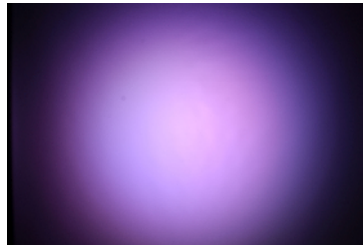

#### LUMILEDS

LED LUXEON 5052 RGBW  
 FWHM / FWTM 32.0° / 57.0°  
 Efficiency 79 %  
 Peak intensity 2.2 cd/m  
 LEDs/each optic 1  
 Light colour RGBW  
 Required components:

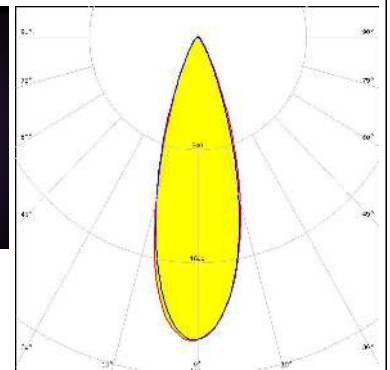
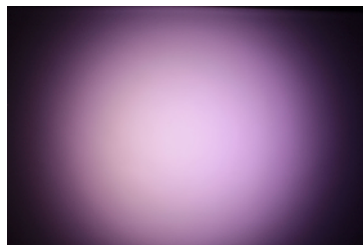

#### LUMILEDS

LED LUXEON CZ  
 FWHM / FWTM 31.0° / 56.0°  
 Efficiency 78 %  
 Peak intensity 2.2 cd/m  
 LEDs/each optic 4  
 Light colour RGBW  
 Required components:

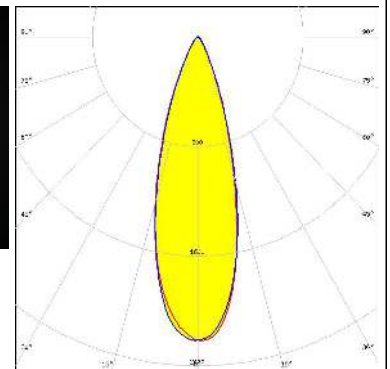
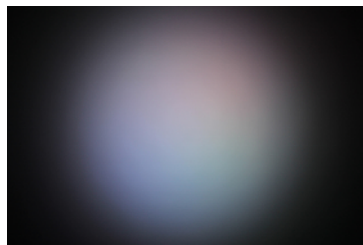

#### LUMINUS



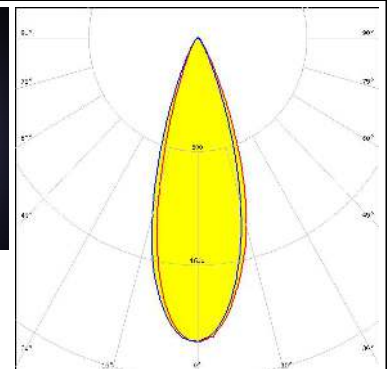
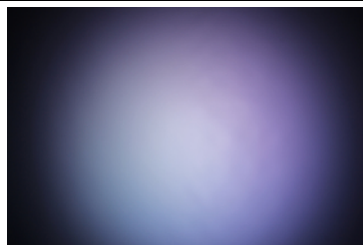

LED SBM-40-RGBW  
 FWHM / FWTM 33.0° / 56.0°  
 Efficiency 80 %  
 Peak intensity 2.1 cd/m  
 LEDs/each optic 1  
 Light colour White  
 Required components:

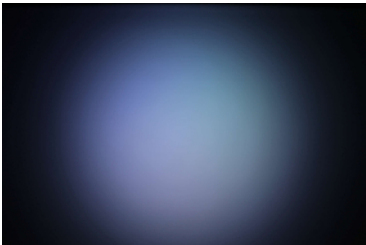
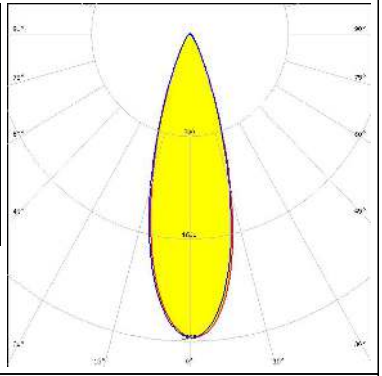
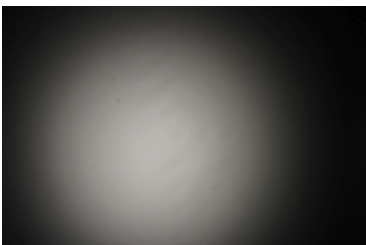
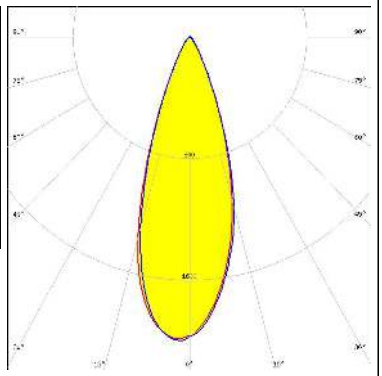
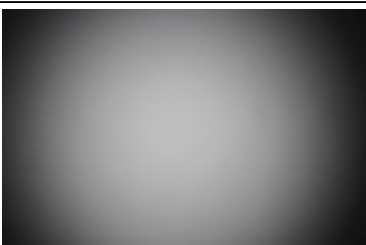
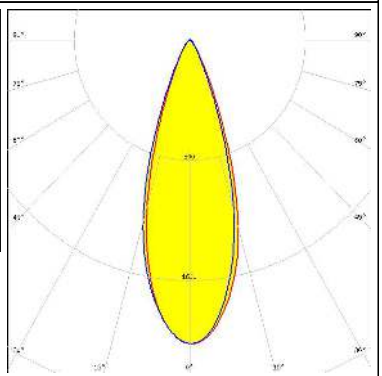
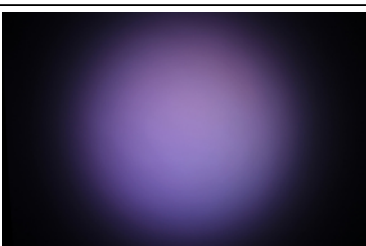
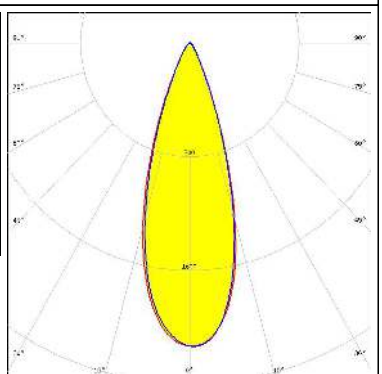



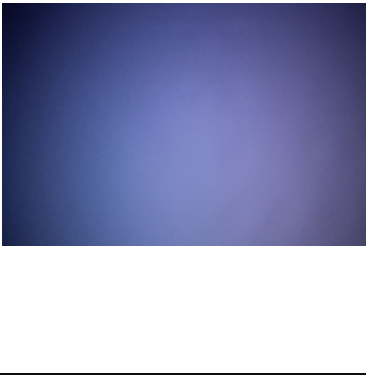
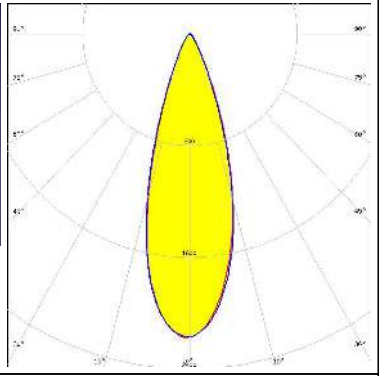

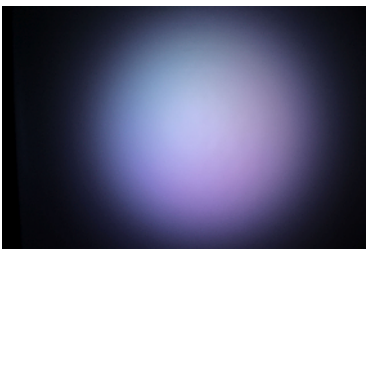
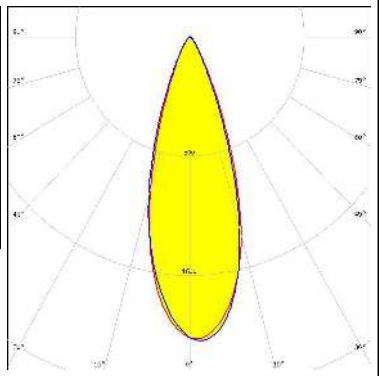

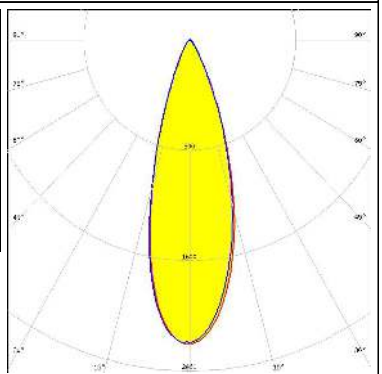
### OPTICAL RESULTS (MEASURED):

<p><b>NICHIA</b></p> <p>LED NCSxE17A            FWHM / FWTM 31.0° / 54.0°            Efficiency 81 %            Peak intensity 2.4 cd/lm            LEDs/each optic 4            Light colour RGBW            Required components:</p>		
<p><b>NICHIA</b></p> <p>LED NVSW219F            FWHM / FWTM 35.0° / 59.0°            Efficiency 80 %            Peak intensity 2 cd/lm            LEDs/each optic 1            Light colour White            Required components:</p>		
<p><b>OSRAM</b>  <small>Opto Semiconductors</small></p> <p>LED OSLO N Square EC            FWHM / FWTM 34.0° / 57.0°            Efficiency 78 %            Peak intensity 2 cd/lm            LEDs/each optic 1            Light colour White            Required components:</p>		
<p><b>OSRAM</b>  <small>Opto Semiconductors</small></p> <p>LED Ostar-SMT RGB            FWHM / FWTM 34.0° / 56.0°            Efficiency 81 %            Peak intensity 2.2 cd/lm            LEDs/each optic 1            Light colour White            Required components:</p>		

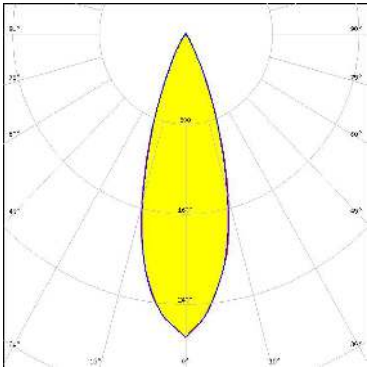
### OPTICAL RESULTS (MEASURED):

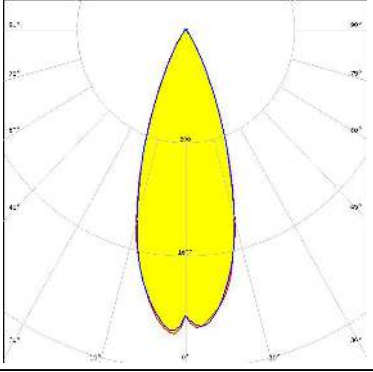
<p> SEOUL SEMICONDUCTOR</p> <p>LED                    SPF05F0A</p> <p>FWHM / FWTM      33.0° / 56.0°</p> <p>Efficiency            78 %</p> <p>Peak intensity      2.2 cd/m</p> <p>LEDs/each optic    1</p> <p>Light colour        RGBW</p> <p>Required components:</p>		
<p> SEOUL SEMICONDUCTOR</p> <p>LED                    SPF05F0B</p> <p>FWHM / FWTM      34.0° / 58.0°</p> <p>Efficiency            80 %</p> <p>Peak intensity      2.1 cd/m</p> <p>LEDs/each optic    1</p> <p>Light colour        RGBW</p> <p>Required components:</p>		
<p> SEOUL SEMICONDUCTOR</p> <p>LED                    SPF05F0C</p> <p>FWHM / FWTM      32.0° / 56.0°</p> <p>Efficiency            79 %</p> <p>Peak intensity      2.2 cd/m</p> <p>LEDs/each optic    1</p> <p>Light colour        RGBW</p> <p>Required components:</p>		

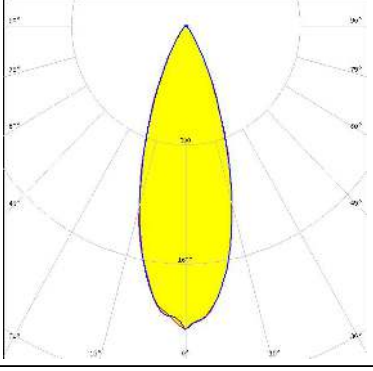
### OPTICAL RESULTS (SIMULATED):

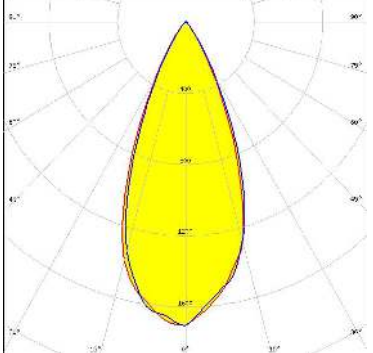
	<p>LED J Series 5050 Round LES            FWHM / FWTM 33.0° / 54.0°            Efficiency 90 %            Peak intensity 2.7 cd/lm            LEDs/each optic 1            Light colour White            Required components:</p>	
	<p>LED XHP50.2            FWHM / FWTM 36.0° / 60.0°            Efficiency 87 %            Peak intensity 2.2 cd/lm            LEDs/each optic 1            Light colour White            Required components:</p>	
	<p>LED XHP70.2            FWHM / FWTM 35.0° / 62.0°            Efficiency 85 %            Peak intensity 2.1 cd/lm            LEDs/each optic 1            Light colour White            Required components:</p>	
	<p>LED XM-L RGBW (XMLDCL HD)            FWHM / FWTM 43.0° / 67.0°            Efficiency 90 %            Peak intensity 1.7 cd/lm            LEDs/each optic 1            Light colour RGBW            Required components:</p>	

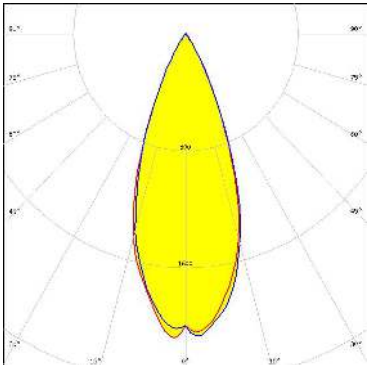
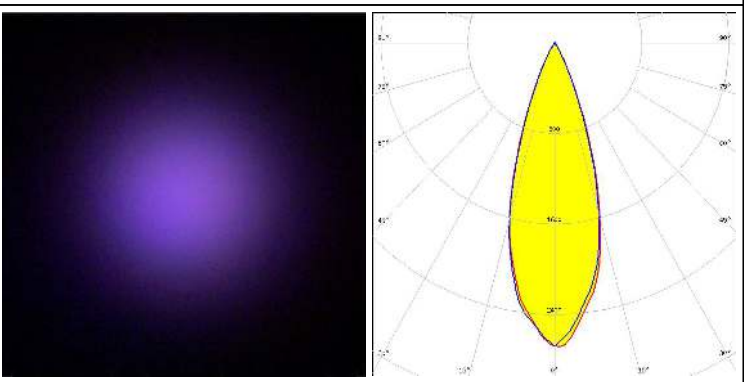
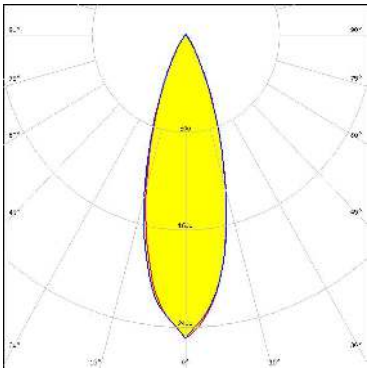
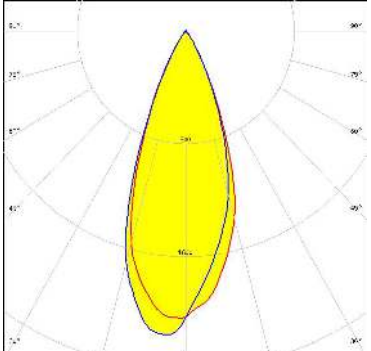

### OPTICAL RESULTS (SIMULATED):

<p><b>CREE</b> LED</p> <p>LED XM-L RGBW (XMLDCL HI)</p> <p>FWHM / FWTM 40.0 + 39.0° / 62.0°</p> <p>Efficiency 91 %</p> <p>Peak intensity 2.1 cd/lm</p> <p>LEDs/each optic 1</p> <p>Light colour RGBW</p> <p>Required components:</p>	
<p><b>LED ENGIN</b></p> <p>LED LZ7 Plus (LZ7-04M2PD)</p> <p>FWHM / FWTM 34.0° / 54.0°</p> <p>Efficiency 90 %</p> <p>Peak intensity 2.7 cd/lm</p> <p>LEDs/each optic 1</p> <p>Light colour White</p> <p>Required components:</p>	
<p><b>LUMILEDS</b></p> <p>LED LUXEON 7070</p> <p>FWHM / FWTM 32.0° / 58.0°</p> <p>Efficiency 87 %</p> <p>Peak intensity 2.5 cd/lm</p> <p>LEDs/each optic 1</p> <p>Light colour White</p> <p>Required components:</p>	
<p><b>LUMILEDS</b></p> <p>LED LUXEON Rubix</p> <p>FWHM / FWTM 39.0 + 38.0° / 62.0 + 61.0°</p> <p>Efficiency 91 %</p> <p>Peak intensity 2.2 cd/lm</p> <p>LEDs/each optic 4</p> <p>Light colour RGBW</p> <p>Required components:</p>	



### OPTICAL RESULTS (SIMULATED):

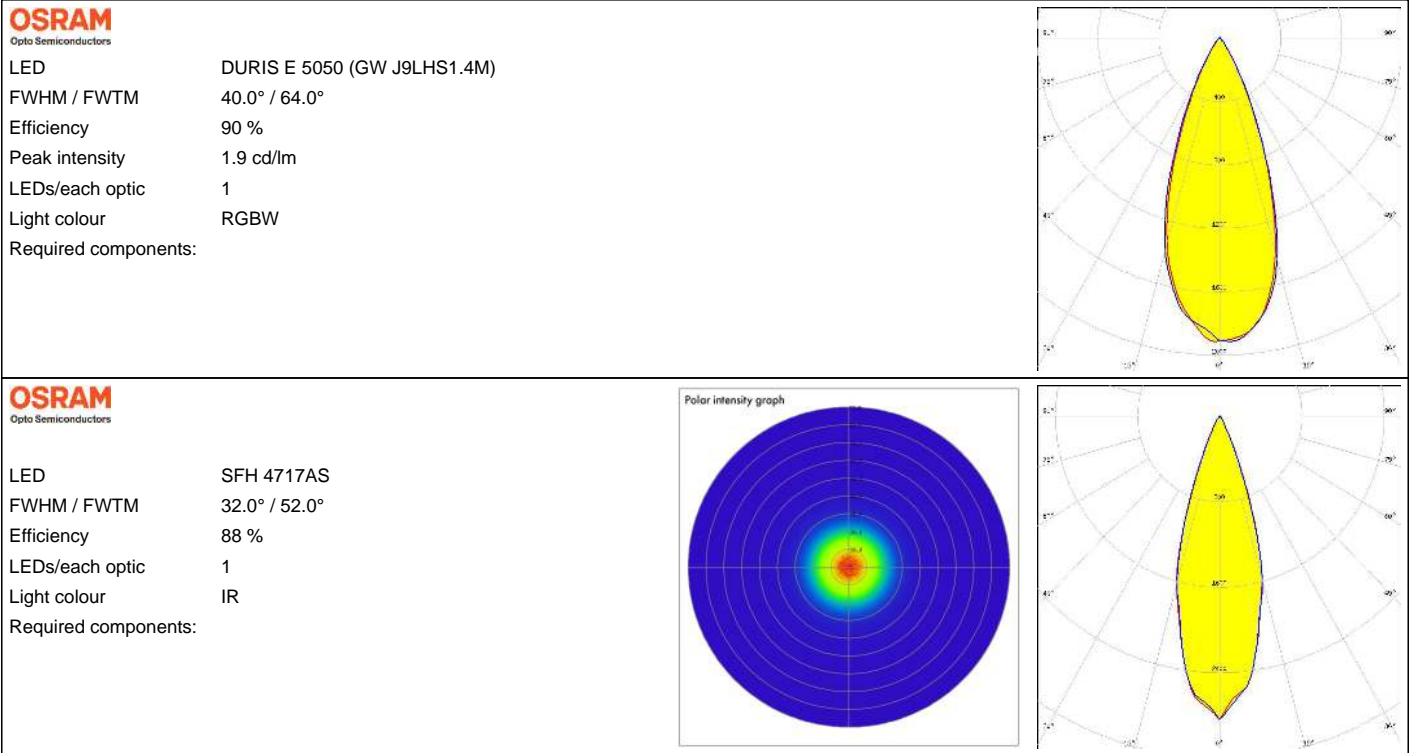

### GENERAL INFORMATION:

NOTE: The typical beam angle will be changed by different color, chip size and chip position tolerance. The typical total beam angle is the full angle measured where the luminous intensity is half of the peak value.

### MATERIALS:

As part of our continuous research and improvement processes, and to ensure the best possible quality and availability of our products, LEDiL reserves the right to change material grades without notice.

### PRODUCT DATA USER AGREEMENT AND DISCLAIMER:

The measured data in the provided downloadable LEDiL Product Datasheets and Mechanical 2D-Drawings is rounded and provided as reference for planning. LEDiL Oy's optical specifications have been verified by conducting performance testing of the products in accordance with the company's quality system. The reported data are averaged results of multiple measurements with typical variation. LEDiL Oy reserves the right to without prior notification make changes and improvements to its products.

LEDiL Oy assumes neither warranty, nor guarantee nor any other liability of any kind for the contents and correctness of the provided data. The provided data has been generated with highest diligence but the provided data may in reality not represent the complete possible variation range of all intrinsic parameters. Therefore, in certain cases a deviation from the provided data could occur.

LEDiL Oy reserves the right to undertake technical changes of its products without further notification which could lead to changes in the provided data. LEDiL Oy assumes no liability of any kind for the possible deviation from any provided data or any other damage resulting from the usage of the provided data.

The user agrees to this disclaimer and user agreement with the download or usage of the provided files.

#### LEDiL Oy

Joensuunkatu 13  
FI-24240 SALO  
Finland

#### LEDiL Inc.

228 West Page Street  
Suite D  
Sycamore IL 60178  
USA

#### Ledil Optics Technology (Shenzhen) Co., Ltd.

# 405 , Block B  
Casic Motor Building  
Shenzhen 518057  
P.R.CHINA

#### Local sales and technical support

[www.ledil.com/  
where\\_to\\_buy](http://www.ledil.com/where_to_buy)

#### Shipping locations

Salo, Finland  
Hong Kong, China

#### Distribution Partners

[www.ledil.com/  
where\\_to\\_buy](http://www.ledil.com/where_to_buy)