



RFID Transponder

IPC03-30P

- Battery-free data carrier
- 32 bit fixcode
- 928 bits memory available
- Readable and writable from both sides
- Mounting holes for simple installation
- Degree of protection IP67 / IP68 / IP69K

Data carrier



Dimensions

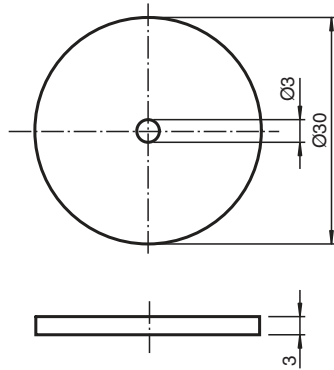

Technical Data

General specifications	
Operating frequency	125 kHz
Transfer rate	2 kBit/s
Memory	
Chip Type	EM4450 Titan (EM Microelectronic)
EEPROM	928 Bit
Read cycles	unlimited
Write cycles	> 100000
Data retention period	10 years at 55 °C (131 °F)
Directive conformity	
Radio equipment	
Directive 2014/53/EU	EN 300330
RoHS	
Directive 2011/65/EU (RoHS)	IEC/EN 63000
Standard conformity	
Degree of protection	EN 60529
RFID	ISO/IEC 18000-2

Release date: 2022-12-15 Date of issue: 2022-12-15 Filename: 192203_eng.pdf

Refer to "General Notes Relating to Pepperl+Fuchs Product Information".

Pepperl+Fuchs Group
www.pepperl-fuchs.com

USA: +1 330 486 0001
fa-info@us.pepperl-fuchs.com

Germany: +49 621 776 1111
fa-info@de.pepperl-fuchs.com

Singapore: +65 6779 9091
fa-info@sg.pepperl-fuchs.com

Technical Data

Ambient conditions	
Ambient temperature	-20 ... 100 °C (-4 ... 212 °F)
Storage temperature	-20 ... 100 °C (-4 ... 212 °F)
Mechanical specifications	
Housing height	3 mm
Housing diameter	30 mm
Degree of protection	IP68
Material	
Housing	PC (Polycarbonate)
Installation	
In air	yes
Construction type	Cylindrical

Reading range in air IPC03-30..

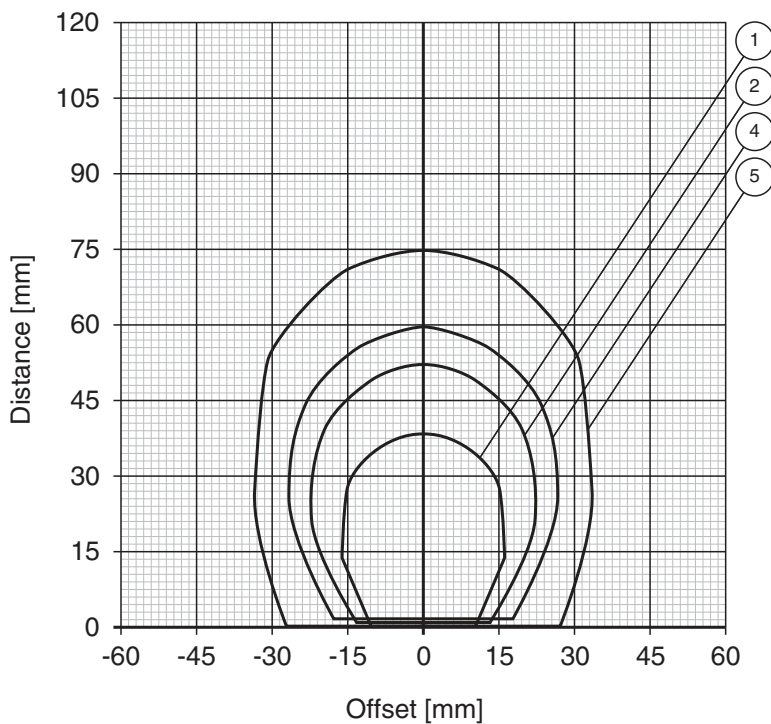

Release date: 2022-12-15 Date of issue: 2022-12-15 Filename: 192203_eng.pdf

Refer to "General Notes Relating to Pepperl+Fuchs Product Information".

Pepperl+Fuchs Group
www.pepperl-fuchs.com

USA: +1 330 486 0001
fa-info@us.pepperl-fuchs.com

Germany: +49 621 776 1111
fa-info@de.pepperl-fuchs.com

Singapore: +65 6779 9091
fa-info@sg.pepperl-fuchs.com

Writing range in air IPC03-30..

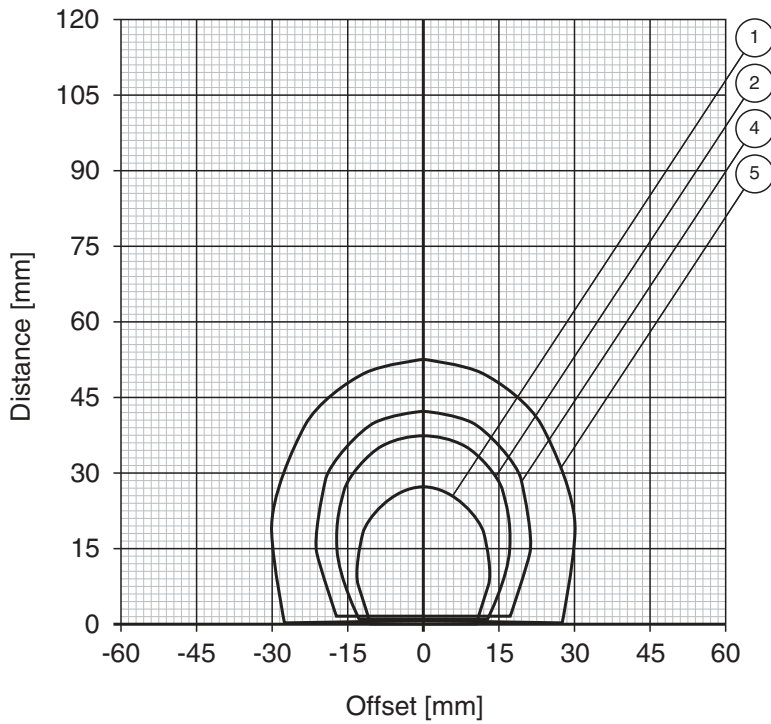

Release date: 2022-12-15 Date of issue: 2022-12-15 Filename: 192203_eng.pdf

Refer to "General Notes Relating to Pepperl+Fuchs Product Information".

Pepperl+Fuchs Group
www.pepperl-fuchs.com

USA: +1 330 486 0001
fa-info@us.pepperl-fuchs.com

Germany: +49 621 776 1111
fa-info@de.pepperl-fuchs.com

Singapore: +65 6779 9091
fa-info@sg.pepperl-fuchs.com

Reading range on aluminium IPC03-30..

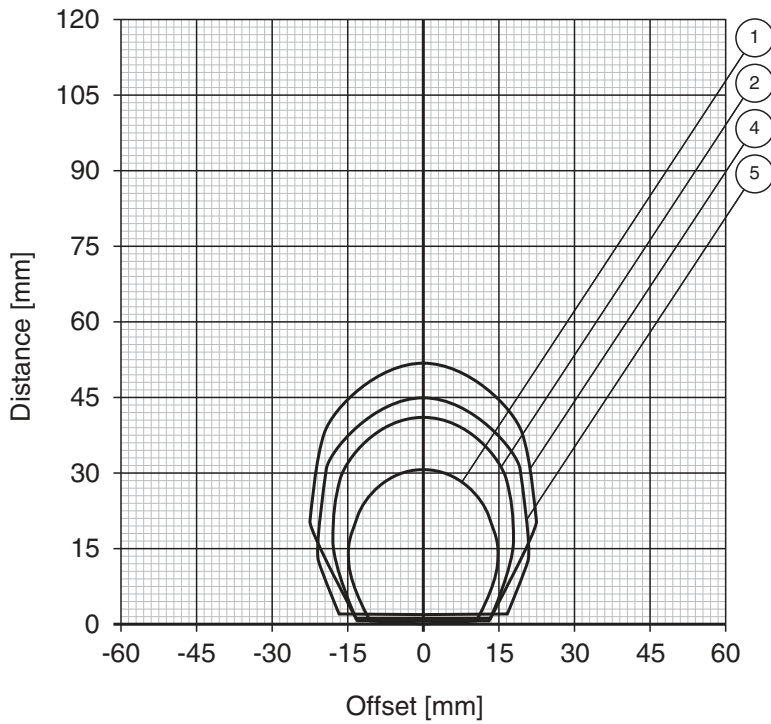

Release date: 2022-12-15 Date of issue: 2022-12-15 Filename: 192203_eng.pdf

Refer to "General Notes Relating to Pepperl+Fuchs Product Information".

Pepperl+Fuchs Group
www.pepperl-fuchs.com

USA: +1 330 486 0001
fa-info@us.pepperl-fuchs.com

Germany: +49 621 776 1111
fa-info@de.pepperl-fuchs.com

Singapore: +65 6779 9091
fa-info@sg.pepperl-fuchs.com

Writing range on aluminium IPC03-30..

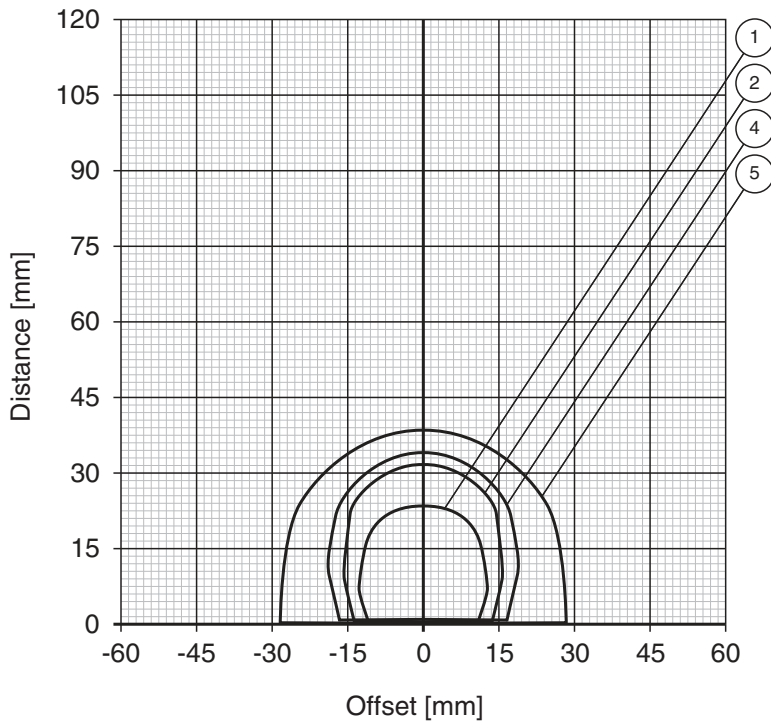

Release date: 2022-12-15 Date of issue: 2022-12-15 Filename: 192203_eng.pdf

Refer to "General Notes Relating to Pepperl+Fuchs Product Information".

Pepperl+Fuchs Group
www.pepperl-fuchs.com

USA: +1 330 486 0001
fa-info@us.pepperl-fuchs.com

Germany: +49 621 776 1111
fa-info@de.pepperl-fuchs.com

Singapore: +65 6779 9091
fa-info@sg.pepperl-fuchs.com

Reading range on steel IPC03-30..

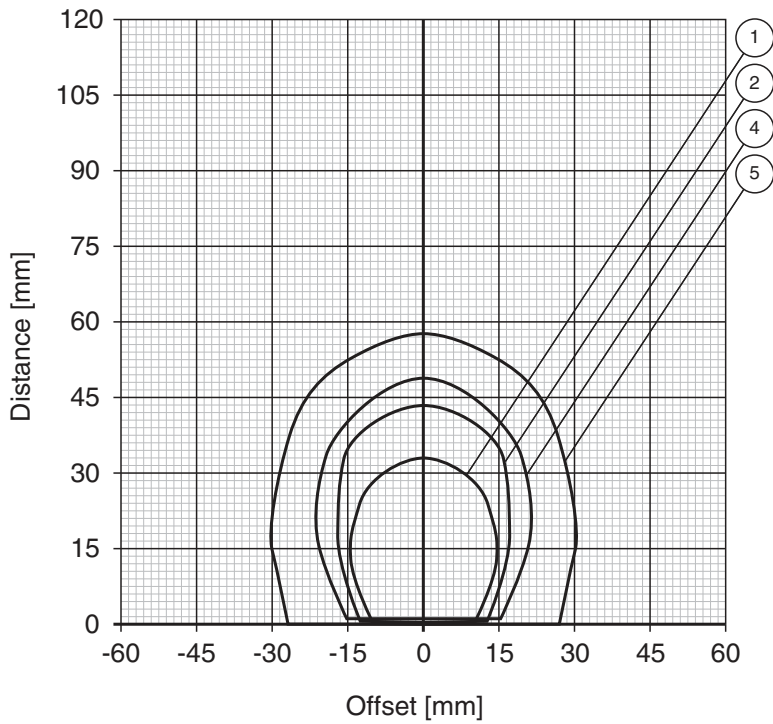

Release date: 2022-12-15 Date of issue: 2022-12-15 Filename: 192203_eng.pdf

Refer to "General Notes Relating to Pepperl+Fuchs Product Information".

Pepperl+Fuchs Group
www.pepperl-fuchs.com

USA: +1 330 486 0001
fa-info@us.pepperl-fuchs.com

Germany: +49 621 776 1111
fa-info@de.pepperl-fuchs.com

Singapore: +65 6779 9091
fa-info@sg.pepperl-fuchs.com

Writing range on steel IPC03-30..

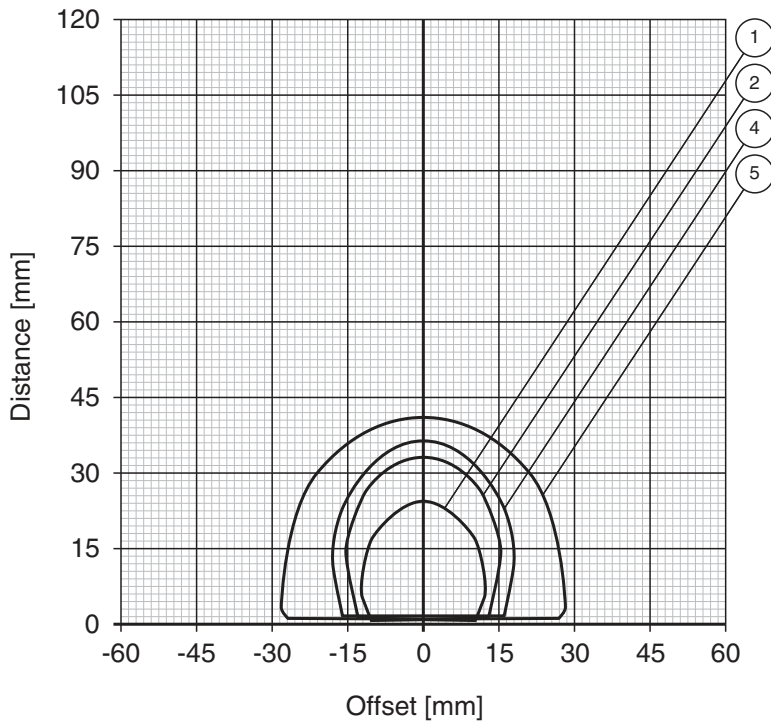

- ① IPH-18GM-V1
 - ③ IPH-F61
 - ⑤ IPH-FP-V1
 - ⑦ IPT1-FP-V1
- ② IPH-30GM-V1
 - ④ IPH-L2-V1
 - ⑥ IPH-F15-V1

Release date: 2022-12-15 Date of issue: 2022-12-15 Filename: 192203_eng.pdf

Refer to "General Notes Relating to Pepperl+Fuchs Product Information".

Pepperl+Fuchs Group
www.pepperl-fuchs.com

USA: +1 330 486 0001
fa-info@us.pepperl-fuchs.com

Germany: +49 621 776 1111
fa-info@de.pepperl-fuchs.com

Singapore: +65 6779 9091
fa-info@sg.pepperl-fuchs.com

Application

The transponder can be read and written from either side.