

EM-93424-010

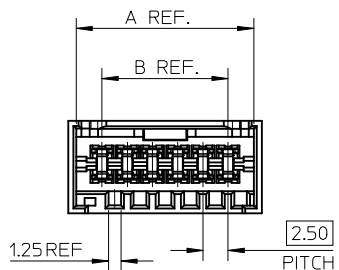

6 CIRCUIT CONNECTOR SHOWN

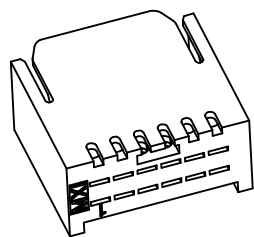
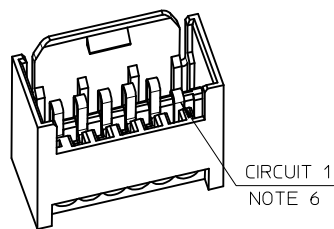

CKT	A	B
2	7.6	2.5
3	10.1	5.0
4	12.6	7.5
5	15.1	10.0
6	17.6	12.5
7	20.1	15.0
8	22.6	17.5
9	25.1	20.0
10	27.6	22.5
11	30.1	25.0
12	32.6	27.5
13	35.1	30.0
14	37.6	32.5
15	40.1	35.0
16	42.6	37.5
17	45.1	40.0
18	47.6	42.5
19	50.1	45

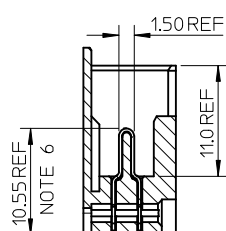
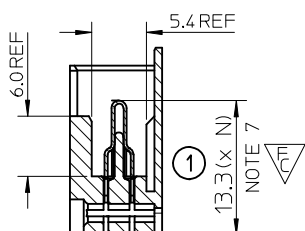
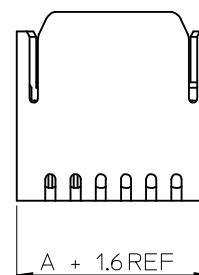
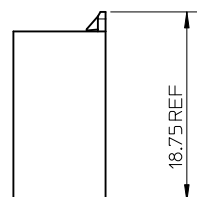
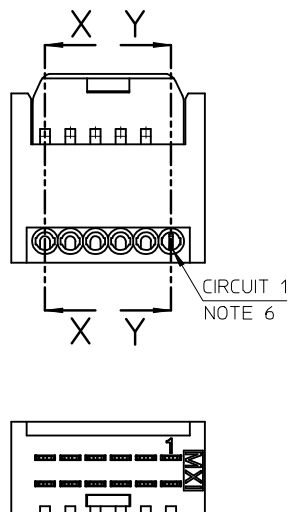
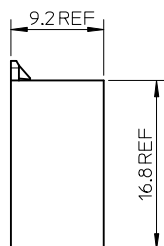

SECTION X-X

NOTES:

- MATERIALS
HOUSING: POLYAMIDE 66 (PA66)
UL94-V0. COLOUR NATURAL.
TERMINAL: COPPER ALLOY.
PLATING: PRE PLATED HOT TIN DIP 4 - 7µm
- PRODUCT CONFORMS TO SPECIFICATION PS-99020-0090.
- MATES WITH RAST 2.5 APPLIMATE FEMALE CONNS.
- SEE PACKAGING SPECIFICATION PK-93422-001.
- CONNECTOR DESIGNED FOR USE WITH PANEL 0.80MM TO 0.90MM THICKNESS.
- TERMINATED HEIGHT. CIRCUIT 1 SHOWN IN TERMINATED POSITION ONLY FOR PURPOSE OF DIMENSIONING TERMINATED HEIGHT POSITION.
- TERMINAL PRE-TERMINATED HEIGHT. N=NUMBER OF CIRCUITS.
- SEE APPLICATION SPEC AS-99033-010.
- CONNECTOR DESIGNED TO RAST 2.5 STANDARD.

LAST INSPECTION NUMBER: 1

Original Release EC NO: IPG2015-0156 DRW: MSHANAHAN 2014/08/25 CHKD: CMONAHAN 2014/10/14 APPR: MSHANAHAN 2014/11/06	QUALITY SYMBOLS FC = 1	GENERAL TOLERANCES (UNLESS SPECIFIED)		DIMENSION STYLE MM ONLY		SCALE 2:1	DESIGN UNITS METRIC	THIRD ANGLE PROJECTION	
			mm	INCH	DRAWN BY MSHANAHAN	DATE 2013/01/30	TITLE VO FLYING HEADER ASSY 0.22 TO 0.38 WIRE 2.5MM PITCH		
		4 PLACES	± ---	± ---	CHECKED BY CMONAHAN	DATE 2014/10/14	molex DOCUMENT NO. SD-93724-001 SHEET NO. 1 OF 4		
		3 PLACES	± ---	± ---	APPROVED BY MSHANAHAN	DATE 2014/11/06			
2 PLACES	± 0.05	± ---	MATERIAL NO.		SEE SHEETS 2+				
1 PLACE	± 0.10	± ---	ANGULAR ± .5 °		THIS DRAWING CONTAINS INFORMATION THAT IS PROPRIETARY TO MOLEX INCORPORATED AND SHOULD NOT BE USED WITHOUT WRITTEN PERMISSION				
0 PLACE	± ---	± ---	DRAFT WHERE APPLICABLE MUST REMAIN WITHIN DIMENSIONS						

2-CIRCUIT

MOLEX PART NO.	MOLEX HSG. PART NO.	BLOCKED POSITION KEYS	CONFIGURATION (SEE NOTES)
93724-0001	93729-0201	NONE	

4-CIRCUIT

MOLEX PART NO.	MOLEX HSG. PART NO.	BLOCKED POSITION KEYS	CONFIGURATION (SEE NOTES)
93724-0003	93729-0401	NONE	

3-CIRCUIT

MOLEX PART NO.	MOLEX HSG. PART NO.	BLOCKED POSITION KEYS	CONFIGURATION (SEE NOTES)
93724-0002	93729-0301	NONE	

5-CIRCUIT

MOLEX PART NO.	MOLEX HSG. PART NO.	BLOCKED POSITION KEYS	CONFIGURATION (SEE NOTES)
93724-0004	93729-0501	NONE	

NOTES:

- ⊕ DENOTES LOADED TERMINAL POSITION
+ DENOTES VOIDED TERMINAL POSITION
- MOLEX HOUSING NUMBER FOR REFERENCE ONLY

a b c d e f

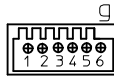
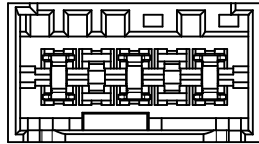

CODING IDENTIFICATION
(6 CKT EXAMPLE WITH
CODING KEY G BLOCKED)
VIEW IN MATING DIRECTION

SEE SHEET 1 EC NO: IPG2015-0156 DRWN:MSHANAHAN 2014/08/25 CHKD:CMONAHAN APPR:MSHANAHAN 2014/11/06	DESCRIPTION	QUALITY SYMBOLS	GENERAL TOLERANCES (UNLESS SPECIFIED)		DIMENSION STYLE MM ONLY		SCALE 3:1	DESIGN UNITS METRIC	THIRD ANGLE PROJECTION			
			mm	INCH	DRAWN BY	DATE	TITLE					
			4 PLACES	± ---	± ---	MSHANAHAN	2013/01/30	VO FLYING HEADER ASSY 0.22 TO 0.38 WIRE 2.5MM PITCH				
			3 PLACES	± ---	± ---	CHECKED BY	DATE					
		2 PLACES	± 0.05	± ---	CMONAHAN	2014/10/14	molex					
		1 PLACE	± 0.10	± ---	APPROVED BY	DATE						
		0 PLACE	± ---	± ---	MSHANAHAN	2014/11/06	MATERIAL NO.		DOCUMENT NO.	SHEET NO.		
			ANGULAR ± .5 °		SEE CHARTS		SD-93724-001		2 OF 4			
		DRAFT WHERE APPLICABLE MUST REMAIN WITHIN DIMENSIONS		SIZE A3	THIS DRAWING CONTAINS INFORMATION THAT IS PROPRIETARY TO MOLEX INCORPORATED AND SHOULD NOT BE USED WITHOUT WRITTEN PERMISSION							

6-CIRCUIT			
MOLEX PART NO.	MOLEX HSG. PART NO.	BLOCKED POSITION KEYS	CONFIGURATION (SEE NOTES)
93724-0005	93729-0601	NONE	

8-CIRCUIT			
MOLEX PART NO.	MOLEX HSG. PART NO.	BLOCKED POSITION KEYS	CONFIGURATION (SEE NOTES)
93724-0007	93729-0801	NONE	

7-CIRCUIT			
MOLEX PART NO.	MOLEX HSG. PART NO.	BLOCKED POSITION KEYS	CONFIGURATION (SEE NOTES)
93724-0006	93729-0701	NONE	

9-CIRCUIT			
MOLEX PART NO.	MOLEX HSG. PART NO.	BLOCKED POSITION KEYS	CONFIGURATION (SEE NOTES)
93724-0008	93729-0901	NONE	

NOTES:

- ⊕ DENOTES LOADED TERMINAL POSITION
+ DENOTES VOIDED TERMINAL POSITION
- MOLEX HOUSING NUMBER FOR REFERENCE ONLY

SEE SHEET 1 EC NO: IPG2015-0156 DRWN:MSHANAHAN 2014/08/25 CHKD:CMONAHAN 2014/10/14 APPR:MSHANAHAN 2014/11/06	DESCRIPTION REV	QUALITY SYMBOLS	GENERAL TOLERANCES (UNLESS SPECIFIED)	DIMENSION STYLE MM ONLY	SCALE 2:1	DESIGN UNITS METRIC	THIRD ANGLE PROJECTION	
			mm INCH	DRAWN BY DATE	TITLE	VO FLYING HEADER ASSY 0.22 TO 0.38 WIRE 2.5MM PITCH SD-93724-001 SHEET NO. 3 OF 4		
		4 PLACES	± --- ± ---	MSHANAHAN 2013/01/30				
		3 PLACES	± --- ± ---	CHECKED BY DATE				
		2 PLACES	± 0.05 ± ---	CMONAHAN 2014/10/14				
1 PLACE	± 0.10 ± ---	APPROVED BY DATE						
0 PLACE	± --- ± ---	MSHANAHAN 2014/11/06		MATERIAL NO.	DOCUMENT NO.			
		ANGULAR ± .5 °	DRAFT WHERE APPLICABLE MUST REMAIN WITHIN DIMENSIONS	SEE CHARTS				
				SIZE A3	THIS DRAWING CONTAINS INFORMATION THAT IS PROPRIETARY TO MOLEX INCORPORATED AND SHOULD NOT BE USED WITHOUT WRITTEN PERMISSION			

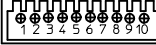
10-CIRCUIT			
MOLEX PART NO.	MOLEX HSG. PART NO.	BLOCKED POSITION KEYS	CONFIGURATION (SEE NOTES)
93724-0009	93729-1001	NONE	

11-CIRCUIT			
MOLEX PART NO.	MOLEX HSG. PART NO.	BLOCKED POSITION KEYS	CONFIGURATION (SEE NOTES)
93724-0010	93729-1101	NONE	

12-CIRCUIT			
MOLEX PART NO.	MOLEX HSG. PART NO.	BLOCKED POSITION KEYS	CONFIGURATION (SEE NOTES)
93724-0011	93729-1201	NONE	

13-CIRCUIT			
MOLEX PART NO.	MOLEX HSG. PART NO.	BLOCKED POSITION KEYS	CONFIGURATION (SEE NOTES)
93724-0012	93729-1301	NONE	

14-CIRCUIT			
MOLEX PART NO.	MOLEX HSG. PART NO.	BLOCKED POSITION KEYS	CONFIGURATION (SEE NOTES)
93724-0013	93729-1401	NONE	

15-CIRCUIT			
MOLEX PART NO.	MOLEX HSG. PART NO.	BLOCKED POSITION KEYS	CONFIGURATION (SEE NOTES)
93724-0014	93729-1501	NONE	

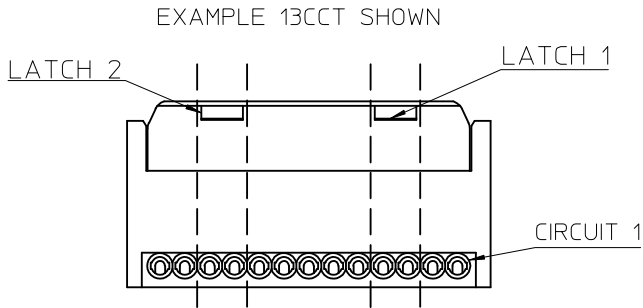

FOR CIRCUIT SIZE 10 AND ABOVE
2 LATCHES ARE PRESENT.
SEE TABLE BELOW FOR
POSITION OF LATCHES

LATCH 1 POSITION	LATCH 2 POSITION	
ACROSS CIRCUITS	ACROSS CIRCUITS	CIRCUIT SIZE
4 & 5	11 & 12	15
4 & 5	10 & 11	14
3 & 4	10 & 11	13
3 & 4	9 & 10	12
3 & 4	8 & 9	11
3 & 4	7 & 8	10

NOTES:

- ⊕ DENOTES LOADED TERMINAL POSITION
+ DENOTES VOIDED TERMINAL POSITION

- MOLEX HOUSING NUMBER FOR REFERENCE ONLY

SEE SHEET 1 EC NO: IPG2015-0156 DRAWN: MSHANAHAN 2014/08/25 CHKD: CMONAHAN 2014/10/14 APPR: MSHANAHAN 2014/11/06	REV DESCRIPTION	QUALITY SYMBOLS	GENERAL TOLERANCES (UNLESS SPECIFIED)	DIMENSION STYLE MM ONLY	SCALE 2:1	DESIGN UNITS METRIC	THIRD ANGLE PROJECTION
			4 PLACES ± --- ± ---	DRAWN BY DATE MSHANAHAN 2013/01/30	TITLE V0 FLYING HEADER ASSY 0.22 TO 0.38 WIRE 2.5MM PITCH		
			3 PLACES ± --- ± ---	CHECKED BY DATE CMONAHAN 2014/10/14			
			2 PLACES ± 0.05 ± ---	APPROVED BY DATE MSHANAHAN 2014/11/06			
			1 PLACE ± 0.10 ± ---	MATERIAL NO.			
			0 PLACE ± --- ± ---	DOCUMENT NO.			
	ANGULAR ± .5 °	SEE CHARTS	SHEET NO. 4 OF 4				
DRAFT WHERE APPLICABLE MUST REMAIN WITHIN DIMENSIONS		THIS DRAWING CONTAINS INFORMATION THAT IS PROPRIETARY TO MOLEX INCORPORATED AND SHOULD NOT BE USED WITHOUT WRITTEN PERMISSION					