

## P-Channel Enhancement Mode Power MOSFET

### Description

The G45P02D3 uses advanced trench technology to provide excellent  $R_{DS(ON)}$ , low gate charge. It can be used in a wide variety of applications.

### General Features

- $V_{DS}$  -20V
- $I_D$  (at  $V_{GS} = -10V$ ) -45A
- $R_{DS(ON)}$  (at  $V_{GS} = -4.5V$ ) < 7.5m $\Omega$
- $R_{DS(ON)}$  (at  $V_{GS} = -2.5V$ ) < 10m $\Omega$
- $R_{DS(ON)}$  (at  $V_{GS} = -1.8V$ ) < 15m $\Omega$
- 100% Avalanche Tested
- RoHS Compliant

### Application

- Power switch
- DC/DC converters

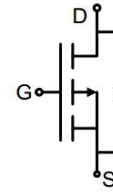

Schematic diagram

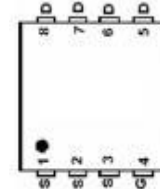

pin assignment



DFN3x3-8L

### Ordering Information

Device	Package	Marking	Packaging
G45P02D3	DFN3x3-8L	G45P02	5000pcs/Reel

### Absolute Maximum Ratings $T_C = 25^\circ\text{C}$ , unless otherwise noted

Parameter	Symbol	Value	Unit
Drain-Source Voltage	$V_{DS}$	-20	V
Continuous Drain Current	$I_D$	-45	A
Pulsed Drain Current (note1)	$I_{DM}$	-180	A
Gate-Source Voltage	$V_{GS}$	$\pm 12$	V
Power Dissipation	$P_D$	29	W
Single pulse avalanche energy (note2)	$E_{AS}$	81	mJ
Operating Junction and Storage Temperature Range	$T_J, T_{stg}$	-55 To 150	$^\circ\text{C}$

### Thermal Resistance

Parameter	Symbol	Value	Unit
Thermal Resistance, Junction-to-Ambient	$R_{thJA}$	75	$^\circ\text{C/W}$
Maximum Junction-to-Case	$R_{thJC}$	4.2	$^\circ\text{C/W}$

Specifications $T_J = 25^\circ\text{C}$ , unless otherwise noted						
Parameter	Symbol	Test Conditions	Value			Unit
			Min.	Typ.	Max.	
<b>Static Parameters</b>						
Drain-Source Breakdown Voltage	$V_{(BR)DSS}$	$V_{GS} = 0V, I_D = -250\mu A$	-20	--	--	V
Zero Gate Voltage Drain Current	$I_{DSS}$	$V_{DS} = -20V, V_{GS} = 0V$	--	--	-1	$\mu A$
Gate-Source Leakage	$I_{GSS}$	$V_{GS} = \pm 12V$	--	--	$\pm 100$	nA
Gate-Source Threshold Voltage	$V_{GS(th)}$	$V_{DS} = V_{GS}, I_D = -250\mu A$	-0.4	-0.65	-1	V
Drain-Source On-Resistance	$R_{DS(on)}$	$V_{GS} = -4.5V, I_D = -10A$	--	6	7.5	m $\Omega$
		$V_{GS} = -2.5V, I_D = -10A$	--	8	10	
		$V_{GS} = -1.8V, I_D = -10A$	--	11	15	
Forward Transconductance	$g_{FS}$	$V_{DS} = -5V, I_D = -10A$	--	72	--	S
<b>Dynamic Parameters</b>						
Input Capacitance	$C_{iss}$	$V_{GS} = 0V,$ $V_{DS} = -10V,$ $f = 1.0MHz$	--	4867	--	pF
Output Capacitance	$C_{oss}$		--	642	--	
Reverse Transfer Capacitance	$C_{rss}$		--	593	--	
Total Gate Charge	$Q_g$	$V_{DD} = -10V,$ $I_D = -10A,$ $V_{GS} = -10V$	--	44	--	nC
Gate-Source Charge	$Q_{gs}$		--	9	--	
Gate-Drain Charge	$Q_{gd}$		--	11	--	
Turn-on Delay Time	$t_{d(on)}$	$V_{DD} = -10V,$ $I_D = -10A,$ $R_G = 3\Omega$	--	18	--	ns
Turn-on Rise Time	$t_r$		--	32	--	
Turn-off Delay Time	$t_{d(off)}$		--	136	--	
Turn-off Fall Time	$t_f$		--	59	--	
<b>Drain-Source Body Diode Characteristics</b>						
Continuous Body Diode Current	$I_S$	$T_C = 25^\circ\text{C}$	--	--	-45	A
Body Diode Voltage	$V_{SD}$	$T_J = 25^\circ\text{C}, I_{SD} = -10A, V_{GS} = 0V$	--	--	-1.2	V
Reverse Recovery Charge	$Q_{rr}$	$I_F = -10A, V_{GS} = 0V$ $di/dt = -500A/\mu s$	--	100	--	nC
Reverse Recovery Time	$T_{rr}$		--	33	--	ns

### Notes

1. Repetitive Rating: Pulse width limited by maximum junction temperature
2. EAS condition :  $T_J = 25^\circ\text{C}, V_{DD} = -20V, V_{GS} = -10V, L = 0.5mH, R_G = 25\Omega$
3. Identical low side and high side switch with identical  $R_G$

### Gate Charge Test Circuit



### Switch Time Test Circuit



### EAS Test Circuit



Typical Characteristics  $T_J = 25^\circ\text{C}$ , unless otherwise noted

**Figure 1. Output Characteristics**

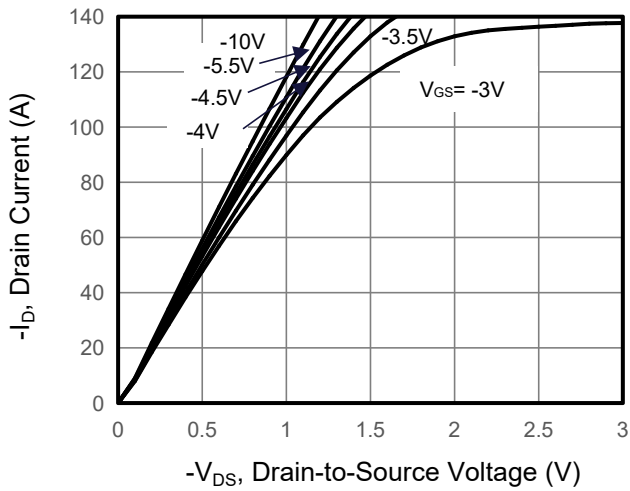

**Figure 2. Transfer Characteristics**

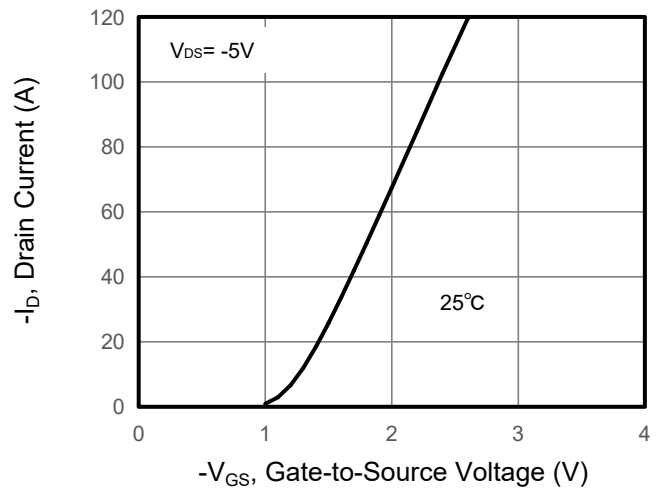

**Figure 3. Drain Source On Resistance**

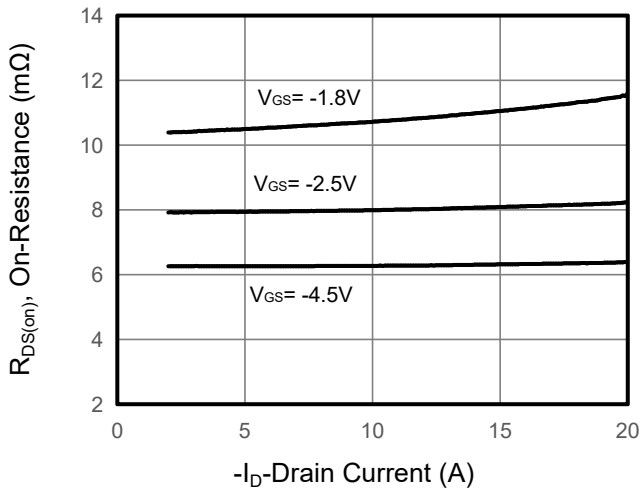

**Figure 4. Gate Charge**

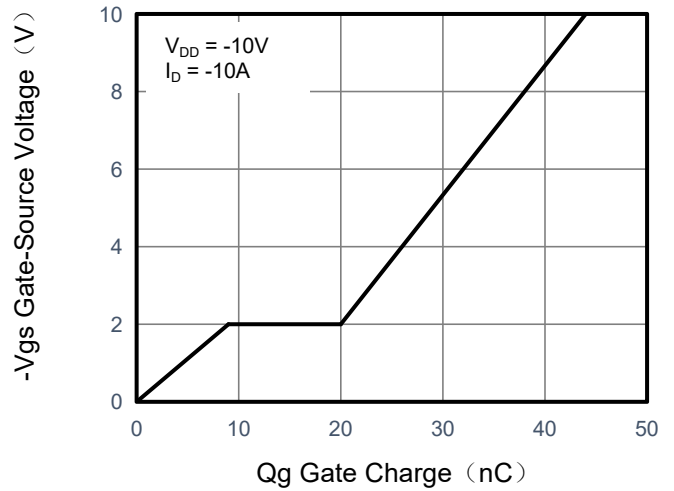

**Figure 5. Capacitance**

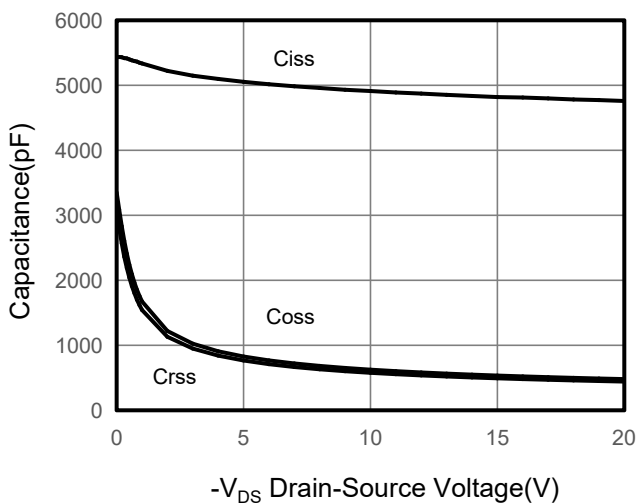

**Figure 6. Source-Drain Diode Forward**

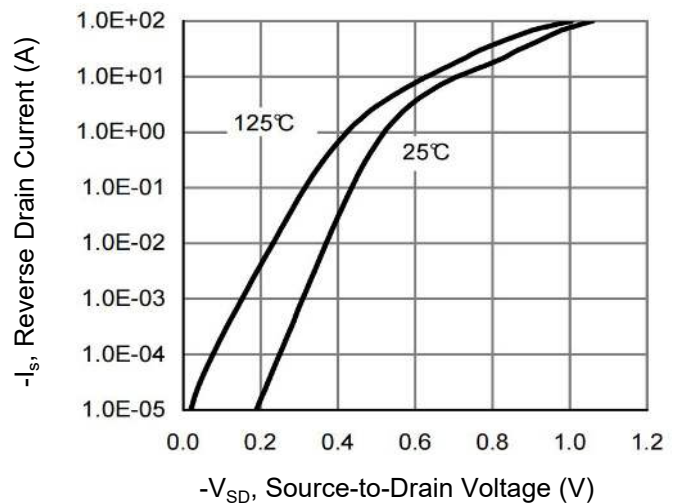

## Typical Characteristics $T_J = 25^\circ\text{C}$ , unless otherwise noted

Figure 7. Drain-Source On-Resistance

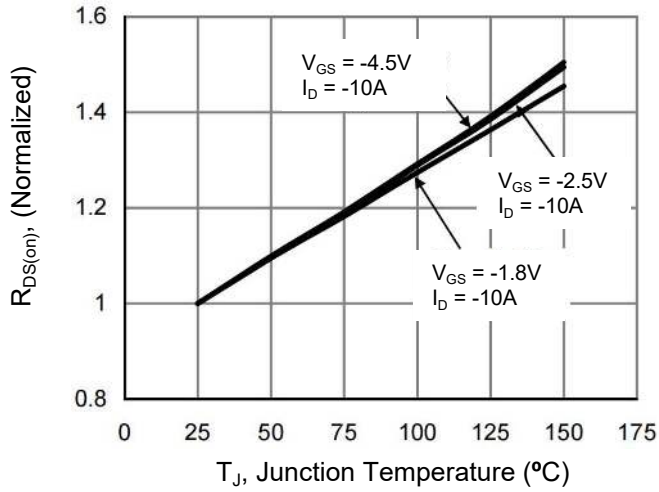

Figure 10. Safe Operation Area

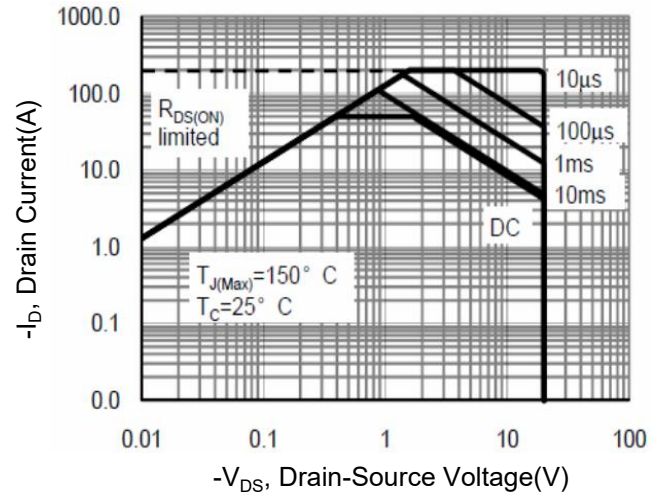
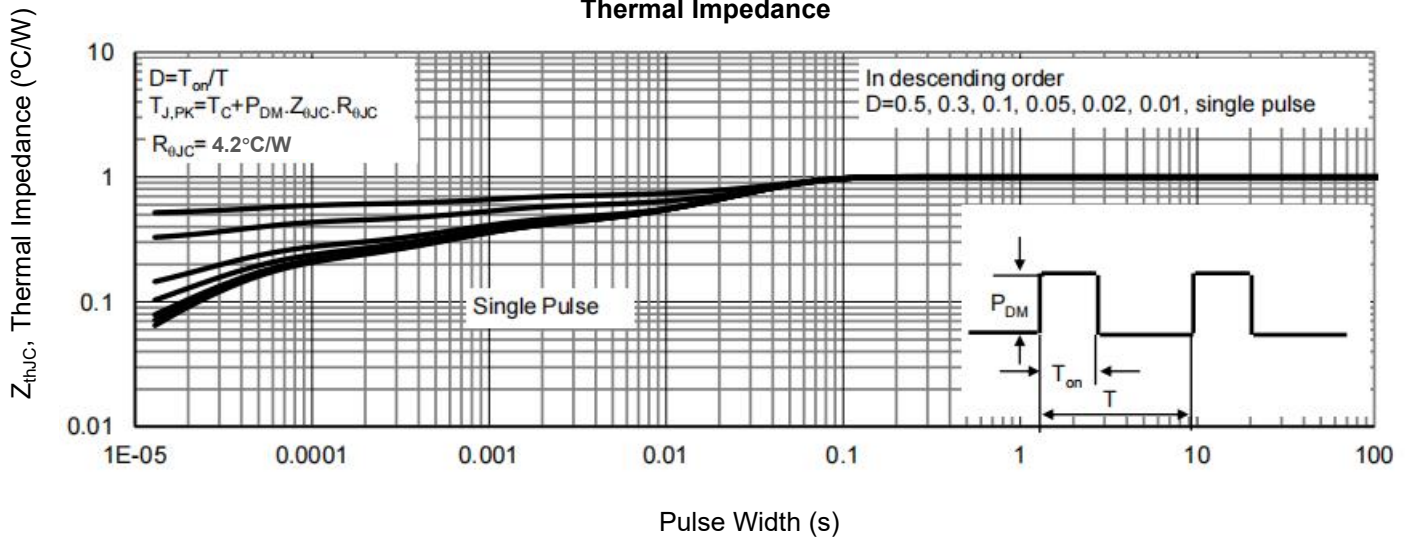
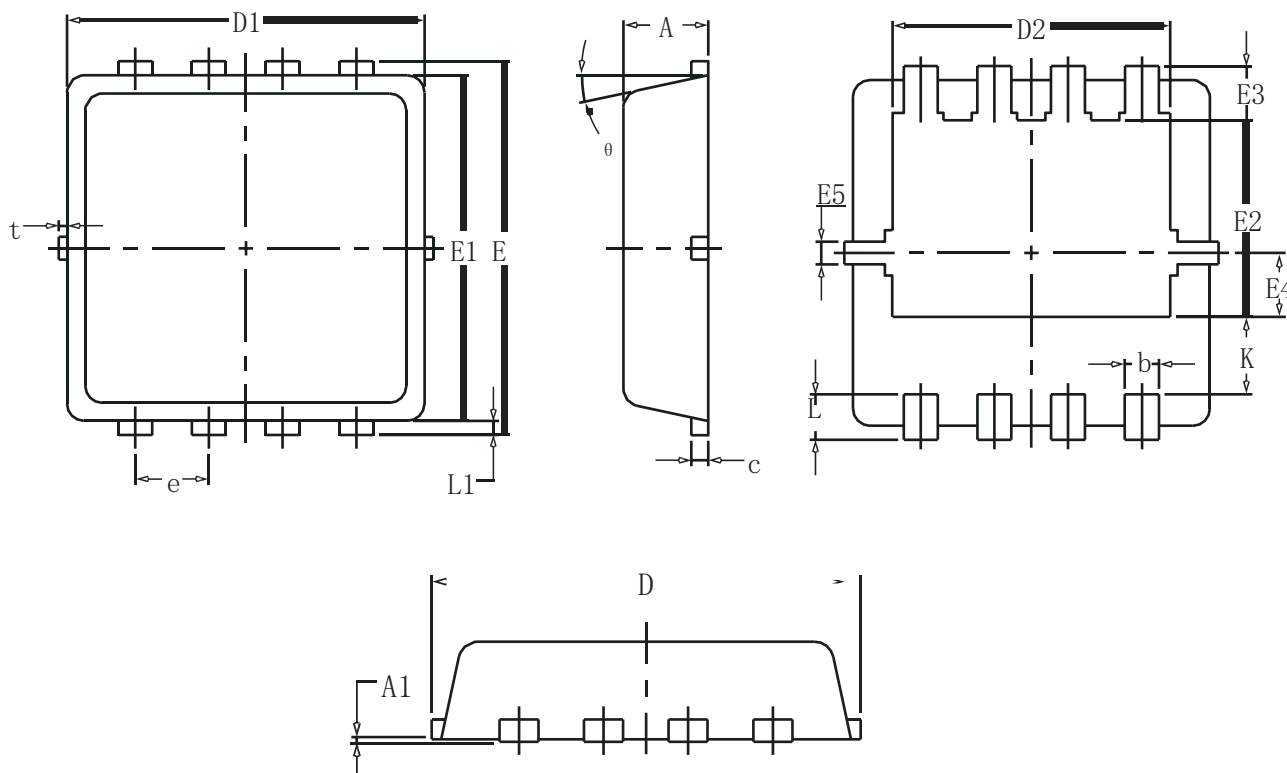

Figure 9. Normalized Maximum Transient Thermal Impedance



## DFN3x3-8L Package Information



SYMBOL	COMMON		
	MM		
	MIN	NOM	MAX
A	0.70	0.75	0.85
A1	-	-	0.05
b	0.20	0.30	0.40
c	0.10	0.152	0.25
D	3.15	3.30	3.45
D1	3.00	3.15	3.25
D2	2.29	2.45	2.65
E	3.15	3.30	3.45
E1	2.90	3.05	3.20
E2	1.54	1.74	1.94
E3	0.28	0.48	0.65
E4	0.37	0.57	0.77
E5	0.10	0.20	0.30
e	0.60	0.65	0.70
K	0.59	0.69	0.89
L	0.30	0.40	0.50
L1	0.06	0.125	0.20
t	0	0.075	0.13
$\theta$	10°	12°	14°