



CCD Signal Processor for Electronic Cameras

AD9803

FEATURES

3-Wire Serial I/F for Digital Control
 18 MHz Correlated Double Sampler
 Low Noise PGA with 0 dB–30 dB Range
 Analog Pre-Blanking Function
 AUX Input with Input Clamp and PGA
 10-Bit 18 MSPS A/D Converter
 Direct ADC Input with Input Clamp
 Internal Voltage Reference
 Two Auxiliary 8-Bit DACs
 +3 V Single Supply Operation
 Low Power: 150 mW at 2.7 V Supply
 48-Lead LQFP Package

PRODUCT DESCRIPTION

The AD9803 is a complete CCD and video signal processor developed for electronic cameras. It is well suited for video camera and still-camera applications.

The 18 MHz CCD signal processing chain consists of a CDS, low noise PGA, and 10-bit ADC. Required clamping circuitry and a voltage reference are also provided. The AUX input features a wideband PGA and input clamp, and can be used to sample analog video signals.

The AD9803 nominally operates from a single 3 V power supply, typically dissipating 170 mW. The AD9803 is packaged in a space-saving 48-lead LQFP and is specified over an operating temperature range of -20°C to $+70^{\circ}\text{C}$.

FUNCTIONAL BLOCK DIAGRAM

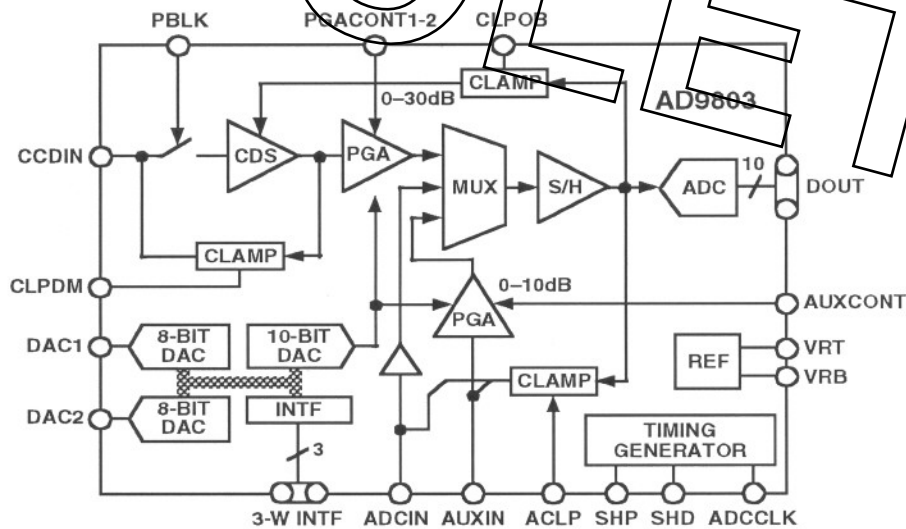

REV. 0

Information furnished by Analog Devices is believed to be accurate and reliable. However, no responsibility is assumed by Analog Devices for its use, nor for any infringements of patents or other rights of third parties which may result from its use. No license is granted by implication or otherwise under any patent or patent rights of Analog Devices.

One Technology Way, P.O. Box 9106, Norwood, MA 02062-9106, U.S.A.
 Tel: 781/329-4700 World Wide Web Site: <http://www.analog.com>
 Fax: 781/326-8703 © Analog Devices, Inc., 1999

AD9803—SPECIFICATIONS

GENERAL SPECIFICATIONS (T_{MIN} to T_{MAX}, ACVDD = ADVDD = DVDD = +2.8 V, f_{ADDCCLK} = 18 MHz unless otherwise noted)

Parameter	Min	Typ	Max	Units
TEMPERATURE RANGE				
Operating	-20		70	°C
Storage	-65		150	°C
POWER SUPPLY VOLTAGE (For Functional Operation)				
Analog	2.7	3.0	3.6	V
Digital	2.7	3.0	3.6	V
Digital Driver	2.7	3.0	3.6	V
POWER CONSUMPTION (Power-Down Modes Selected Through Serial I/F)				
Normal Operation (D-Reg 00)	(Specified Under Each Mode of Operation)			
High Speed AUX-MODE (D-Reg 01)	(Specified Under AUX-MODE)			
Reference Standby (D-Reg 10 or STBY Pin Hi)		10		mW
Shutdown Mode (D-Reg 11)		10		mW
MAXIMUM CLOCK RATE (Specified Under Each Mode of Operation)				
SH AMPLIFIER				
Gain		0		dB
Clock Rate			27	MHz
A/D CONVERTER				
Resolution	10			Bits
Differential Nonlinearity				
0-255 Code		±0.5	±0.8	LSBs
256-1023 Code		±0.5	±1.0	LSBs
No Missing Codes		GUARANTEED		
Full-Scale Input Range		1.6		V p-p
Clock Rate	0.01		18	MHz
REFERENCE				
Reference Top Voltage		1.75		V
Reference Bottom Voltage		1.25		V

Specifications subject to change without notice.

DIGITAL SPECIFICATIONS (T_{MIN} to T_{MAX}, DVDD = +2.7 V, C_L = 20 pF unless otherwise noted)

Parameter	Symbol	Min	Typ	Max	Units
LOGIC INPUTS					
High Level Input Voltage	V _{IH}	2.1			V
Low Level Input Voltage	V _{IL}			0.6	V
High Level Input Current	I _{IH}		10		μA
Low Level Input Current	I _{IL}		10		μA
Input Capacitance	C _{IN}		10		pF
LOGIC OUTPUTS					
High Level Output Voltage	V _{OH}	2.1			V
Low Level Output Voltage	V _{OL}			0.6	V
High Level Output Current	I _{OH}		50		μA
Low Level Output Current	I _{OL}		50		μA
SERIAL INTERFACE TIMING (Figure 35)					
Maximum SCLK Frequency		10			MHz
SDATA to SCLK Setup	t _{DS}	10			ns
SCLK to SDATA Hold	t _{DH}	10			ns
SLOAD to SCLK Setup	t _{LS}	10			ns
SCLK to SLOAD Hold	t _{LH}	10			ns

Specifications subject to change without notice.

CCD-MODE SPECIFICATIONS

(T_{MIN} to T_{MAX} , $ACVDD = ADVDD = DVDD = +2.8 V$, $f_{SHP} = f_{SHD} = f_{ADCCLK} = 18 MHz$ unless otherwise noted)

Parameter	Min	Typ	Max	Units
POWER CONSUMPTION				
$V_{DD} = 2.7$		150		mW
$V_{DD} = 2.8$		170		mW
$V_{DD} = 3.0$		185		mW
MAXIMUM CLOCK RATE	18			MHz
CDS				
Gain		0		dB
Allowable CCD Reset Transient ¹		500		mV
Max Input Range Before Saturation ¹	1000			mV p-p
PGA				
Max Input Range	1000			mV p-p
Max Output Range	1000			mV p-p
Digital Gain Control (See Figure 26)				
Gain Control Resolution		10 (Fixed)		Bits
Minimum Gain (Code 0)	-3.5	-1.5	0	dB
Low Gain (Code 207)	0	4	8	dB
Medium Gain (Code 437)		15		dB
High Gain (Code 688)	22	26	30	dB
Max Gain (Code 1023)	32			dB
Analog Gain Control (See Figure 25)				
PGACONT1 = 0.7 V, PGACONT2 = 1.5 V		4.5		dB
PGACONT1 = 1.8 V, PGACONT2 = 1.5 V		26		dB
BLACK-LEVEL CLAMP				
Clamp Level (Selected by the Serial I/F)				
CLP(0) (E-Reg 00)		34		LSB
CLP(1) (E-Reg 01)		50		LSB
CLP(2) (E-Reg 10)		66		LSB
CLP(3) (E-Reg 11)		18		LSB
Even-Odd Offset ²		±0.5		LSB
SIGNAL-TO-NOISE RATIO³ (@ Minimum PGA Gain)		61		dB
TIMING SPECIFICATIONS⁴				
Pipeline Delay				
Even-Odd Offset Correction Disabled		5		Cycles
Even-Odd Offset Correction Enabled		7		Cycles
Internal Clock Delay ⁵ (t_{ID})		3		ns
Inhibited Clock Period ($t_{INHIBIT}$)	15			ns
Output Delay (t_{OD})			20	ns
Output Hold Time (t_{HOLD})	2			ns
ADCCLK, SHP, SHD, Clock Period	47	55.6		ns
ADCCLK Hi-Level, Or Low Level	20	28		ns
SHP, SHD Minimum Pulsewidth ⁶	10	14		ns
SHP Rising Edge to SHD Rising Edge	20	28		ns

NOTES

¹Input Signal Characteristics defined as shown:

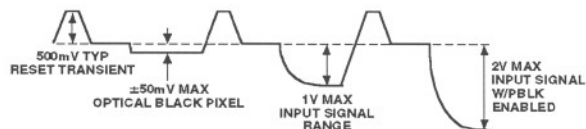

²Even-Odd Offset is described under the Theory of Operation section. The Even-Odd Offset is measured with the Even-Off Offset correction enabled.

³SNR = $20 \log_{10}$ (Full-Scale Voltage/RMS Output Noise).

⁴20 pF loading; timing shown in Figure 1.

⁵Internal aperture delay for actual sampling edge.

⁶Active Low Clock Pulse Mode (C-Reg 00).

Specifications subject to change without notice.

AD9803—SPECIFICATIONS

AUX-MODE SPECIFICATIONS (T_{MIN} to T_{MAX}, ACVDD = ADVDD = DVDD = +2.8 V, f_{ADCLK} = 18 MHz unless otherwise noted)

Parameter	Min	Typ	Max	Units
POWER CONSUMPTION				
Normal (D-Reg 00)		80		mW
High Speed (D-Reg 01)		110		mW
MAXIMUM CLOCK RATE	18			MHz
PGA				
Max Input Range	700			mV p-p
Max Output Range	1000			mV p-p
Digital Gain Control		8 (Fixed)		Bits
Gain Control Resolution				
Gain (Selected by the Serial I/F)				
Gain(0)		-3.5		dB
Gain(255)		10.5		dB
ACTIVE CLAMP (CLAMP ON)				
Clamp Level (Selectable by the Serial I/F)				
CLP(0) (E-Reg 00)		34		LSB
CLP(1) (E-Reg 01)		50		LSB
CLP(2) (E-Reg 10)		66		LSB
CLP(3) (E-Reg 11)		18		LSB
TIMING SPECIFICATIONS¹				
Pipeline Delay		4 (Fixed)		Cycles
Internal Clock Delay (t _{ID})			5	ns
Output Delay (t _{OD})			20	ns
Output Hold Time (t _{HOLD})	2			ns

NOTES¹20 pF loading; timing shown in Figure 2.

Specifications subject to change without notice.

ADC-MODE SPECIFICATIONS (T_{MIN} to T_{MAX}, ACVDD = ADVDD = DVDD = +2.8 V, f_{ADCLK} = 18 MHz unless otherwise noted)

Parameter	Min	Typ	Max	Units
POWER CONSUMPTION (Normal D-Reg 00)				
		65		mW
MAXIMUM CLOCK RATE	18			MHz
ACTIVE CLAMP (Same as AUX-MODE)				
TIMING SPECIFICATIONS (Same as AUX-MODE)				

Specifications subject to change without notice.

DAC SPECIFICATIONS (DAC1 and DAC2)

Parameter	Min	Typ	Max	Units
RESOLUTION				
		8 (Fixed)		Bits
MIN OUTPUT				
		0.1		V
MAX OUTPUT				
		VDD - 0.1		V
MAX CURRENT LOAD				
		1		mA
MAX CAPACITIVE LOAD				
		500		pF

Specifications subject to change without notice.

TIMING SPECIFICATIONS

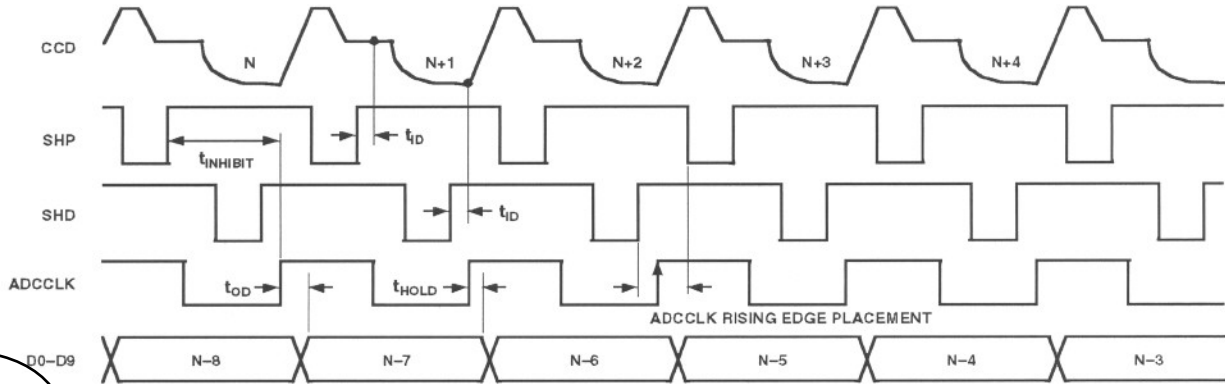

- NOTES:
1. SHP AND SHD SHOULD BE OPTIMALLY ALIGNED WITH THE CCD SIGNAL. SAMPLES ARE TAKEN AT THE RISING EDGES.
 2. ADCCLK RISING EDGE MUST OCCUR AT LEAST 15ns AFTER THE RISING EDGE OF SHP ($t_{INHIBIT}$).
 3. RECOMMENDED PLACEMENT FOR ADCCLK RISING EDGE IS BETWEEN THE RISING EDGE OF SHD AND FALLING EDGE OF SHP.
 4. OUTPUT LATENCY (7 CYCLES) SHOWN WITH EVEN-ODD OFFSET CORRECTION ENABLED.
 5. ACTIVE LOW CLOCK PULSE MODE IS SHOWN.

Figure 1. CCD-MODE Timing

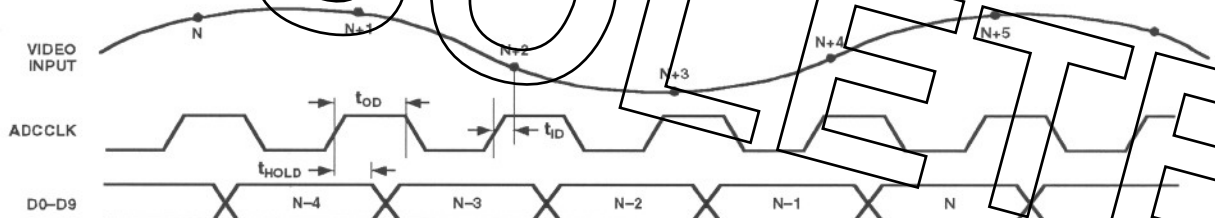

NOTE:
EXAMPLE OF OUTPUT DATA LATCHED BY ADCCLK RISING EDGE.

Figure 2. AUX-MODE and ADC-MODE Timing

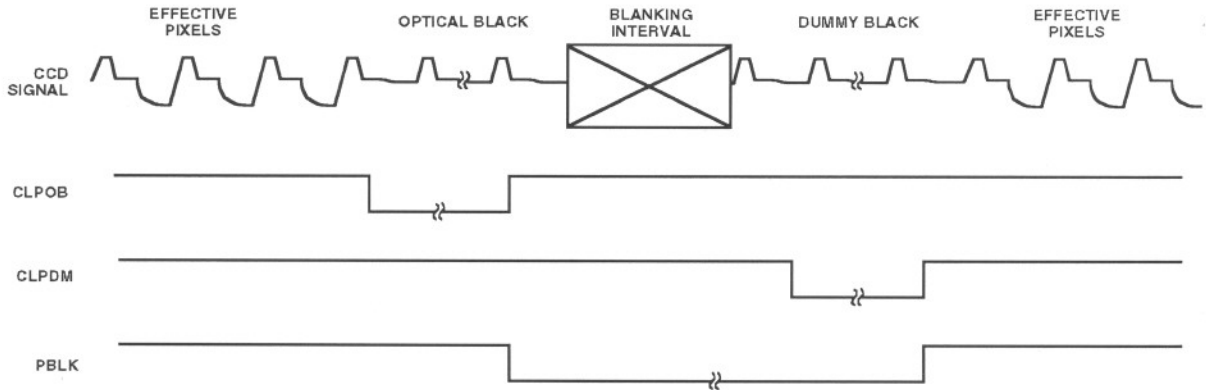

- NOTES:
1. CLPOB PULSEWIDTH SHOULD BE A MINIMUM OF 10 OB PIXELS WIDE, 20 OB PIXELS ARE RECOMMENDED.
 2. CLPDM PULSEWIDTH SHOULD BE AT LEAST 1 μ s WIDE.
 3. PBLK IS NOT REQUIRED, BUT RECOMMENDED IF THE CCD SIGNAL AMPLITUDE EXCEEDS 1V p-p.
 4. CLPDM OVERRIDES PBLK.
 5. ACTIVE LOW CLAMP PULSE MODE IS SHOWN.

Figure 3. CCD-MODE Clamp Timing

AD9803

TIMING SPECIFICATIONS (CONTINUED)

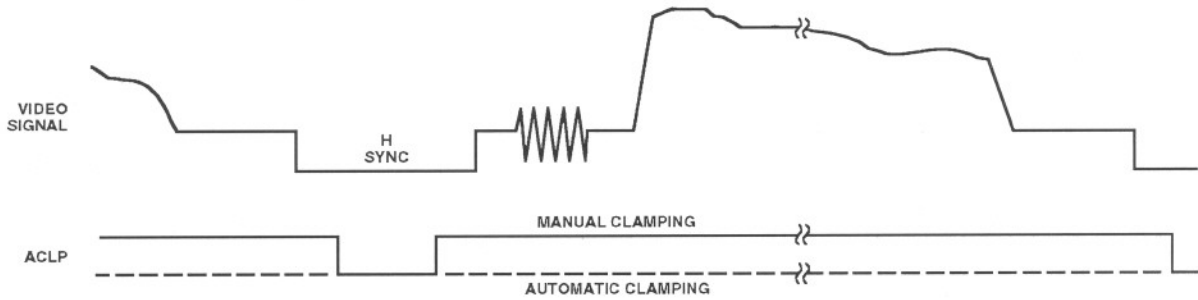

Figure 4. AUX-MODE Clamp Timing

NOTE: ACLP can be used two different ways. To control the exact time of the clamp, an active low pulse is used to specify the clamp interval. Alternatively, ACLP may be tied to ground. In this configuration, the clamp circuitry will sense the most

negative portion of the signal and use this level to set the clamp voltage. For the video waveform in Figure 4, the SYNC level will be clamped to the black level specified in the E-Register. Active low clamp pulse mode is shown.

ABSOLUTE MAXIMUM RATINGS*

Parameter	With Respect To	Min	Max	Units
ADVDD	ADVSS, SUBST	-0.3	6.5	V
ACVDD	ACVSS, SUBST	-0.3	6.5	V
DVDD	DVSS	-0.3	6.5	V
DRVDD	DRVSS	-0.3	6.5	V
CLOCK INPUTS	DVSS	-0.3	DVDD + 0.3	V
PGACONT1, PGACONT2	SUBST	-0.3	ACVDD + 0.3	V
PIN, DIN	SUBST	-0.3	ACVDD + 0.3	V
DOUT	DRVSS	-0.3	DRVDD + 0.3	V
VRT, VRB	SUBST	-0.3	ADVDD + 0.3	V
CCDBYP1, CCDBYP2	SUBST	-0.3	ACVDD + 0.3	V
DAC1, DAC2	SUBST	-0.3	ACVDD + 0.3	V
DRVSS, DVSS, ACVSS, ADVSS	SUBST	-0.3	+0.3	V
Junction Temperature			+150	°C
Storage Temperature		-65	+150	°C
Lead Temperature (10 sec)			+300	°C

*Stresses above those listed under Absolute Maximum Ratings may cause permanent damage to the device. This is a stress rating only; functional operation of the device at these or other conditions above those indicated in the operational sections of this specification is not implied. Exposure to absolute maximum ratings for extended periods may affect device reliability.

ORDERING GUIDE

Model	Temperature Range	Package Description	Package Option
AD9803JST	0°C to +70°C	48-Lead Plastic Thin Quad Flatpack	ST-48

CAUTION

ESD (electrostatic discharge) sensitive device. Electrostatic charges as high as 4000 V readily accumulate on the human body and test equipment and can discharge without detection. Although the AD9803 features proprietary ESD protection circuitry, permanent damage may occur on devices subjected to high energy electrostatic discharges. Therefore, proper ESD precautions are recommended to avoid performance degradation or loss of functionality.



AD9803

PIN CONFIGURATION

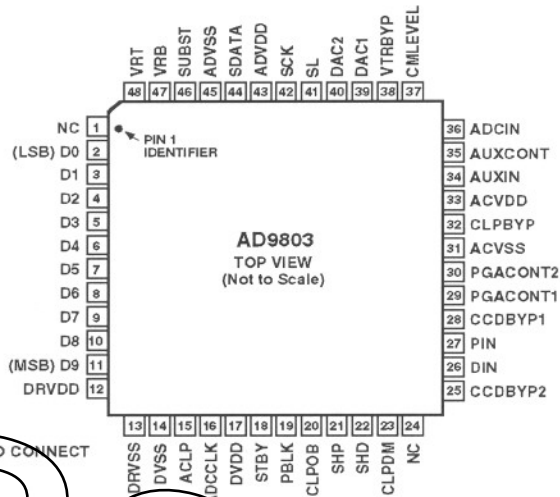

PIN FUNCTION DESCRIPTIONS

Pin #	Pin Name	Type	Description (See Figures 37 and 38 for Circuit Configurations)
1, 24	NC		No Connect (Should be Left Floating or Tied to Ground)
2-11	D0-D9	DO	Digital Data Outputs
12	DRVDD	P	Digital Driver Supply (3 V)
13	DRVSS	P	Digital Driver Ground
14	DVSS	P	Digital Ground
15	ACLP	P	AUX-MODE/ADC-MODE Clamp
16	ADCCLK	DI	ADC Sample Clock Input
17	DVDD	P	Digital Supply (3 V)
18	STBY	DI	Power-Down Mode (Active Hi/Internal Pull-Down). Enables Reference Stand-By Mode.
19	PBLK	DI	Pixel Blanking
20	CLPOB	DI	Black Level Restore Clamp
21	SHP	DI	CCD Reference Sample Clock Input
22	SHD	DI	CCD Data Sample Clock Input
23	CLPDM	DI	Input Clamp
25	CCDBYP2	AO	CDS Ground Bypass (0.1 μ F to Ground)
26	DIN	AI	CDS Negative Input (Tie to Pin 27 and AC-Couple to CCD Input Signal)
27	PIN	AI	CDS Positive Input (See Above)
28	CCDBYP1	AO	CDS Ground Bypass (0.1 μ F to Ground)
29	PGACONT1	AI	PGA Coarse Gain Analog Control
30	PGACONT2	AI	PGA Fine Gain Analog Control
31	ACVSS	P	Analog Ground
32	CLPBYP	AO	Bias Bypass (0.1 μ F to Ground)
33	ACVDD	P	Analog Supply (3 V)
34	AUXIN	AI	AUX-MODE Input
35	AUXCONT	AI	AUX-MODE PGA Gain Analog Control
36	ADCIN	AI	ADC-MODE Input
37	CMLEVEL	AO	Common-Mode Level (0.1 μ F to Ground)
38	VTRBYP	AO	Bias Bypass (0.1 μ F to Ground)
39	DAC1	AO	DAC1 Output
40	DAC2	AO	DAC2 Output
41	SL	DI	Serial I/F Load Signal
42	SCK	DI	Serial I/F Clock
43	ADVDD	P	Analog Supply (3 V)
44	SDATA	DI	Serial I/F Input Data
45	ADVSS	P	Analog Ground
46	SUBST	P	Analog Ground
47	VRB	AO	Bottom Reference (0.1 μ F to Ground and 1 μ F to VRT)
48	VRT	AO	Top Reference (0.1 μ F to Ground)

NOTE

Type: AI = Analog Input, AO = Analog Output, DI = Digital Input, DO = Digital Output, P = Power.

AD9803

EQUIVALENT INPUT CIRCUITS

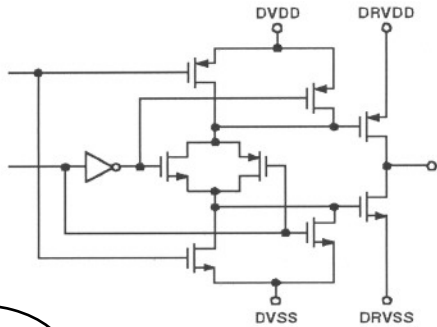

Figure 5. Pins 2-11 (D0-D9)

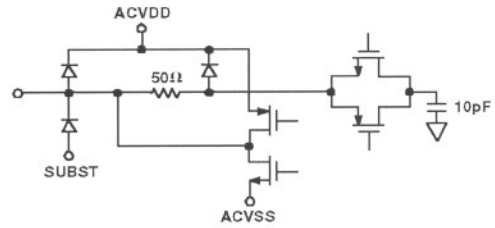

Figure 8. Pin 26 (DIN) and Pin 27 (PIN)

OBSOLETE

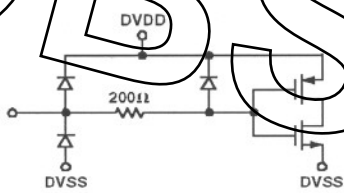

Figure 6. Pin 16, 21, 22 (ADCCLK, SHP, SHD)

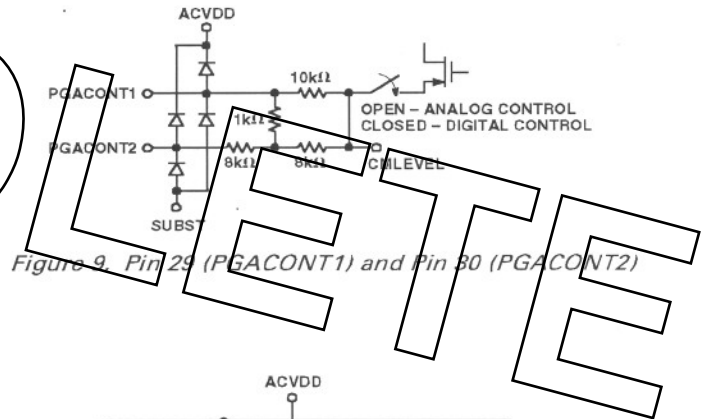

Figure 9. Pin 29 (PGACONT1) and Pin 30 (PGACONT2)

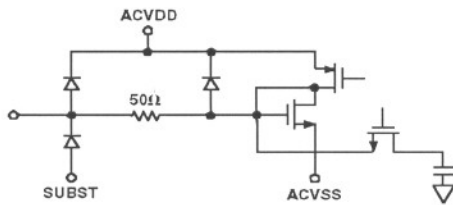

Figure 7. Pins 25, 28 (CCDBYP)

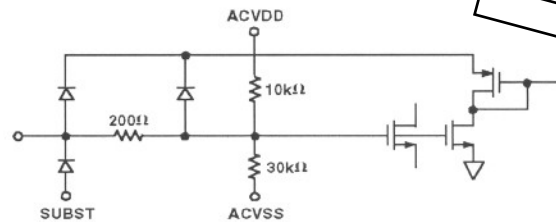

Figure 10. Pin 32 (CLPBYP)

AD9803

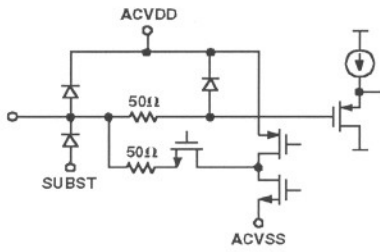

Figure 11. Pin 34 (AUXIN) and Pin 36 (ADCIN)

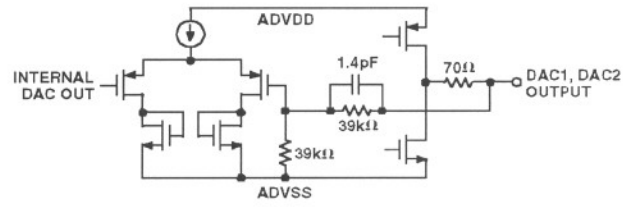

Figure 14. Pin 39 (DAC1) and 40 (DAC2)

OBSOLETE



Figure 12. Pin 35 (AUXCONT)

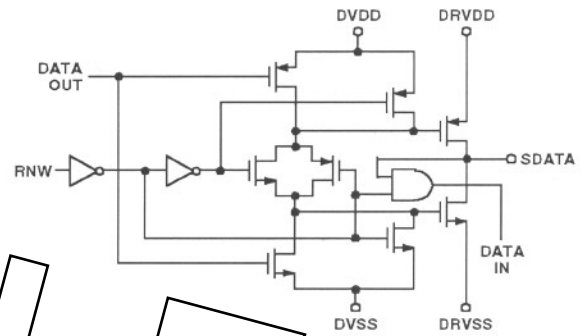

Figure 15. Pin 44 (SDATA)

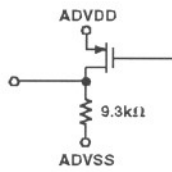

Figure 13. Pin 37 (CMLEVEL)

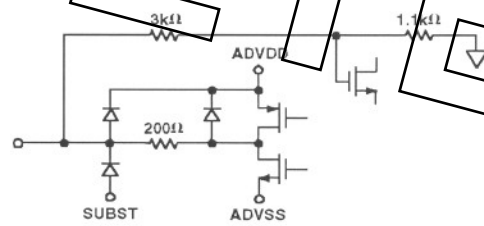

Figure 16. Pin 47 (VRB) and Pin 48 (VRT)

AD9803—Typical Performance Characteristics

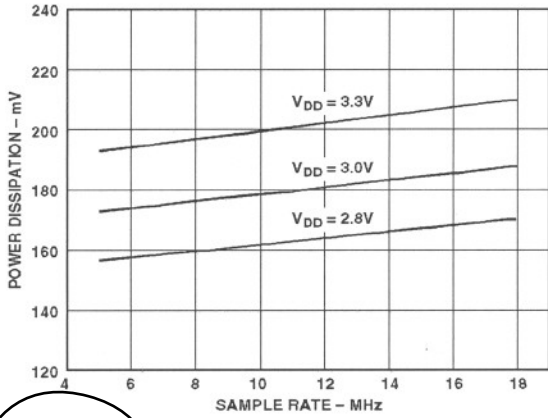

Figure 17. CCD-MODE Power vs. Clock Rate

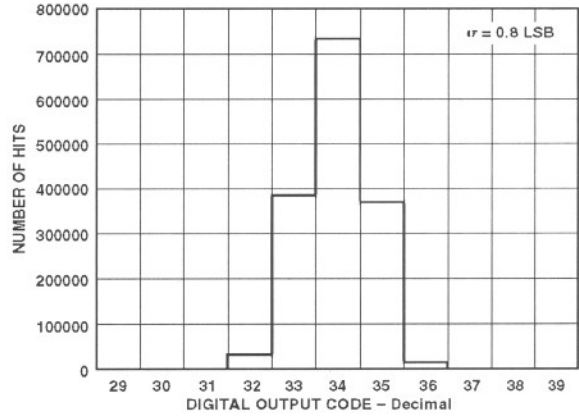

Figure 20. CCD-MODE Grounded-Input Noise (PGA Gain = MIN)

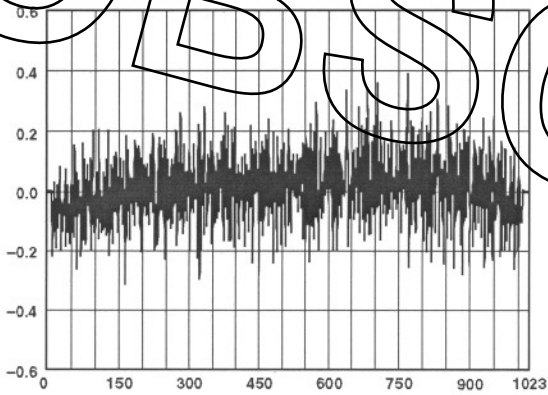

Figure 18. CCD-MODE DNL at 18 MHz

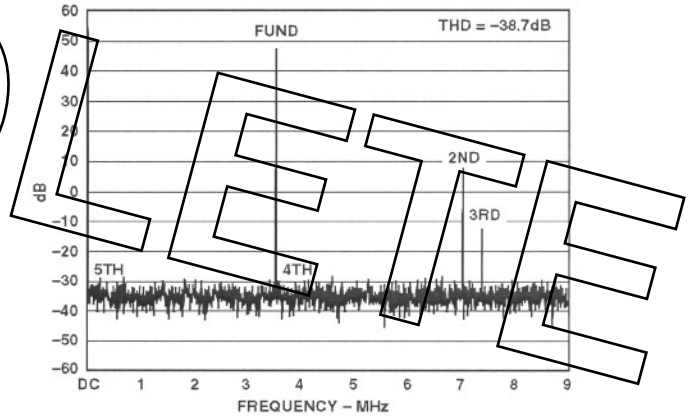

Figure 21. AUX-MODE THD at 18 MHz ($f_{IN} = 3.54$ MHz at -3 dB)

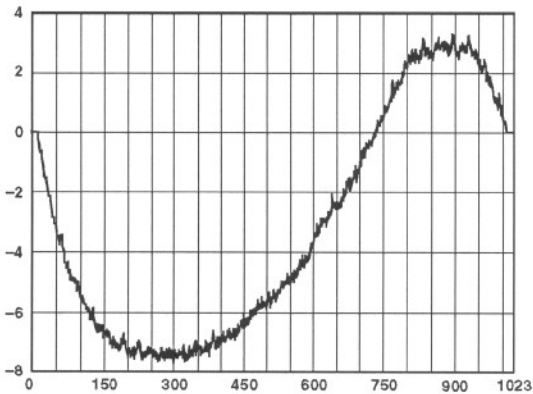

Figure 19. CCD-MODE INL at 18 MHz

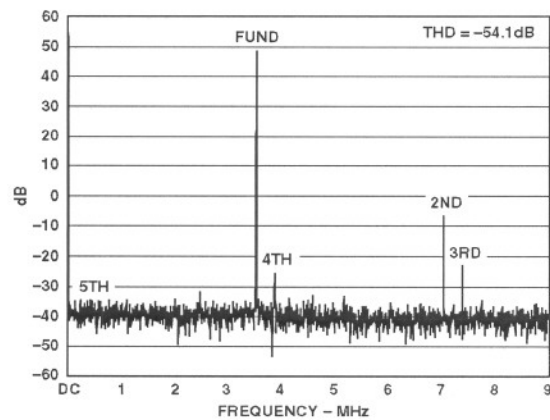

Figure 22. ADC-MODE THD at 18 MHz ($f_{IN} = 3.54$ MHz at -3 dB)

OBSOLETE

AD9803

THEORY OF OPERATION

Introduction

The AD9803 is a 10-bit analog-to-digital interface for CCD cameras. The block level diagram of the system is shown in Figure 23. The device includes a correlated double sampler (CDS), 0 dB–30 dB programmable gain amplifier (PGA), black level correction loop, input clamp and voltage reference. The only external analog circuitry required at the system level is an emitter follower buffer between the CCD output and AD9803 inputs.

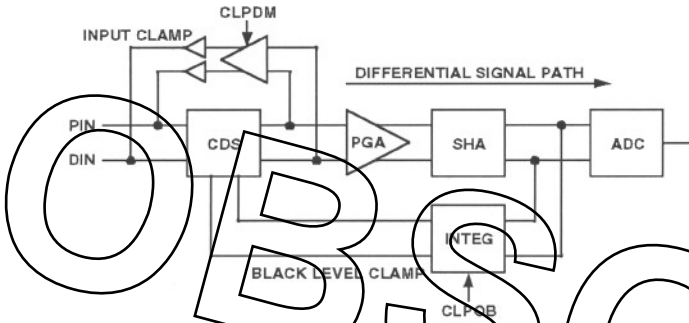

Figure 23. CCD Mode Signal Path

Correlated Double Sampling (CDS)

CDS is important in high performance CCD systems as a method for removing several types of noise. Basically, two samples of the CCD output are taken: one with the signal present (“data”) and one without (“reference”). Subtracting these two samples removes any noise which is common—or correlated—to both.

Figure 24 shows the block diagram of the AD9803’s CDS. The S/H blocks are directly driven by the input and the sampling function is performed passively, without the use of amplifiers. This implementation relies on the off-chip emitter follower buffer to drive the two 10 pF sampling capacitors. Only one capacitor at a time is seen at the input pin.

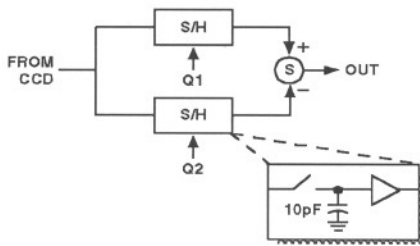

Figure 24. CDS Block Diagram

The AD9803 actually uses two CDS circuits in a “ping pong” fashion to allow the system more acquisition time. In this way, the output from one of the two CDS blocks will be valid for an entire clock cycle. Thus, the bandwidth requirement of the subsequent gain stage is reduced as compared to that for a single-channel CDS system. This lower bandwidth translates to lower power and noise.

Programmable Gain Amplifier (PGA)

The on-chip PGA provides a gain range of 0 dB–30 dB, which is “linear in dB.” Typical gain characteristics are shown in Figures 25 and 26.

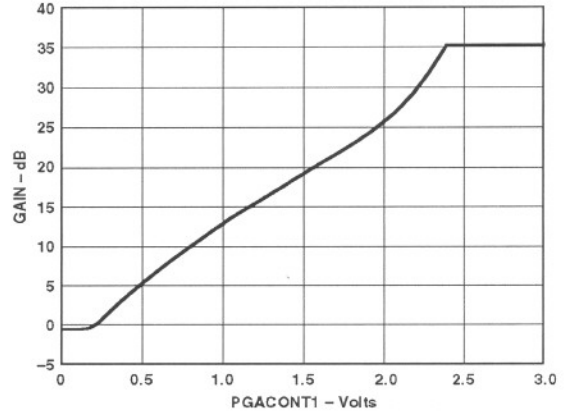

Figure 25. PGA Gain Curve—Analog Control

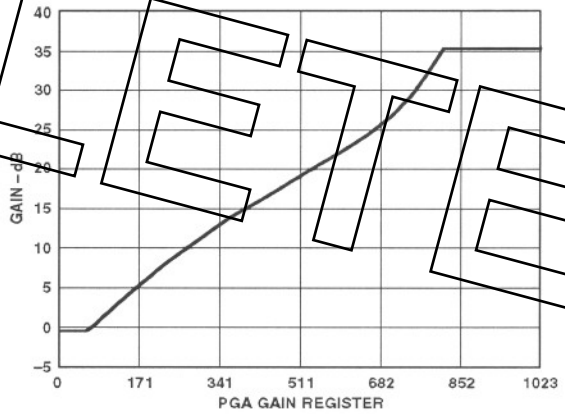

Figure 26. PGA Gain Curve—Digital Control

As shown in Figure 27, analog PGA control is provided through the PGACONT1 and PGACONT2 inputs. PGACONT1 provides coarse and PGACONT2 fine (1/16) gain control. The PGA gain can also be controlled using the internal 10-bit DAC through the serial digital interface. The gain characteristic shown in Figure 26, with the internal DAC providing the same control range as PGACONT1. See the Serial Interface Specifications for more details.

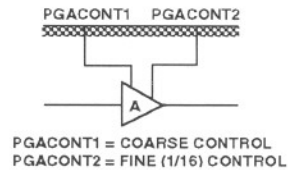

Figure 27. Analog PGA Control

AD9803

Black Level Clamping

For correct signal processing, the CCD signal must be referenced to a well established "black level." The AD9803 uses the CCD's optical black (OB) pixels as a calibration signal, which is used to establish the black level. Two sources of offset are addressed during the calibration—the CCD's own "black level" offset, and the AD9803's internal offsets in the CDS and PGA circuitry.

The feedback loop shown in Figure 28 is closed around the PGA during the calibration interval (CLPOB = LOW) to set the black level. As the black pixels are being processed, an integrator block measures the difference between the input level and the desired reference level. This difference, or error, signal is amplified and passed to the CDS block where it is added to the incoming pixel data. As a result of this process, the black pixels are digitized at one end of the ADC range, taking maximum advantage of the available linear range of the system. Using the AD9803's serial digital interface, the black level reference may be programmed to 16 LSB, 32 LSB, 48 LSB, or 64 LSB.

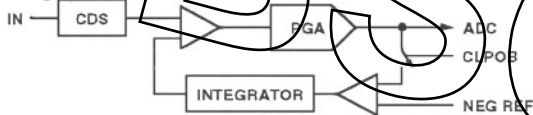

Figure 28. Black Level Correction Loop (Simplified)

The actual implementation of this loop is slightly more complicated as shown in Figure 29. Because there are two separate CDS blocks, two black level feedback loops are required and two offset voltages are developed. Figure 29 also shows an additional PGA block in the feedback loop labeled "RPGA." The RPGA uses the same control inputs as the PGA, but has the inverse gain. The RPGA functions to attenuate by the same factor as the PGA amplifies, keeping the gain and bandwidth of the loop constant.

There exists an unavoidable mismatch in the two offset voltages used to correct both CDS blocks. This mismatch causes a slight difference in the offset level for odd and even pixels, often called "pixel-to-pixel offset" or "even-odd offset." To compensate for this mismatch, the AD9803 uses a digital correction circuit after the ADC which removes the even-odd offset between the channels.

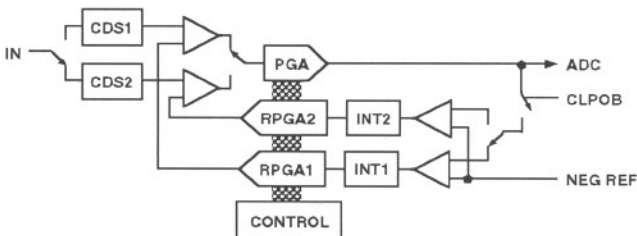

Figure 29. Black Level Correction Loop (Detailed)

Input Bias Level Clamping

The buffered CCD output is connected to the AD9803 through an external coupling capacitor. The dc bias point for this coupling capacitor is established during the clamping (CLPDM = LOW) period using the "dummy clamp" loop shown in Figure 30. When closed around the CDS, this loop establishes the desired dc bias point on the coupling capacitor.

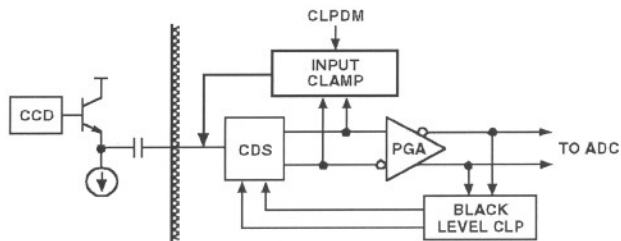

Figure 30. Input Clamp

Input Blanking

In some applications, the AD9803's input may be exposed to large signals from the CCD, either during blanking intervals or "high speed" modes. If the signals are larger than the AD9803's 1 V p-p input signal range, then the on-chip input circuitry may saturate. Recovery time from a saturated state could be substantial.

To avoid problems associated with processing these large transients, the AD9803 includes an input blanking function. When active (PBLK = LOW) this function stops the CDS operation and allows the user to disconnect the CDS inputs from the CCD buffer. Additionally, the AD9803's digital outputs will all go to zero while PBLK is low.

If the input voltage exceeds the supply rail by more than 0.3 volts, then protection diodes will be turned on, increasing current flow into the AD9803 (see Equivalent Input Circuits). Such voltage levels should be externally clamped to prevent possible device damage.

10-Bit Analog-to-Digital Converter (ADC)

The ADC employs a multibit pipelined architecture which is well-suited for high throughput rates while being both area and power efficient. The multistep pipeline presents a low input capacitance resulting in lower on-chip drive requirements. A fully differential implementation was used to overcome headroom constraints of the single +3 V power supply.

Differential Reference

The AD9803 includes a 0.5 V reference based on a differential, continuous-time bandgap cell. Use of an external bypass capacitor reduces the reference drive requirements, thus lowering the power dissipation. The differential architecture was chosen for its ability to reject supply and substrate noise. Required decoupling is shown in Figure 31.

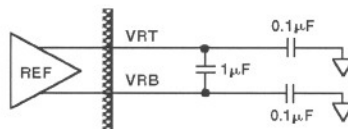

Figure 31. Reference Decoupling

Internal Timing

The AD9803's on-chip timing circuitry generates all clocks necessary for operation of the CDS and ADC blocks. The user needs only to synchronize the SHP and SHD clocks with the CCD waveform, as all other timing is handled internally. The ADCCLK signal is used to strobe the output data, and can be adjusted to accommodate desired timing. Figure 1 shows the recommended placement of ADCCLK relative to SHP and SHD.

AD9803

Even-Odd Pixel Offset Correction

The AD9803 includes digital correction circuitry following the 10-bit ADC. The purpose of the digital correction is remove the residual offset between the even and odd pixel channels, which results from the "ping-pong" CDS architecture of the AD9803. The digital offset correction tracks the black level of the even and odd channels, applying the necessary digital correction value to keep them balanced. There is an additional two cycle delay when using the offset correction, resulting in pipeline delay of 7 ADCCLK cycles (see Figure 1).

The recommended method of controlling the input clamp is to simply ground the ACLP input (Pin 15) to activate the "automatic" clamping capability of the AD9803. The clamp may also be controlled with a separate clock signal. See the clamp timing in Figure 4 for more details.

The THD performance for $f_s = 18$ MHz is shown in Figure 21. When operating at $f_s = 18$ MHz, the linearity performance is comparable to the CCD-Mode linearity, shown in Figure 18. The AUX-MODE can be operated at a sampling rate of up to 28.6 MHz. If the sample rate exceeds 18 MHz, then the High Speed AUX-MODE should be programmed through the serial interface (D-Register 01).

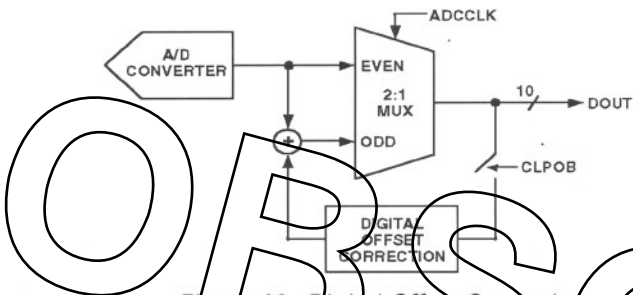

Figure 32. Digital Offset Correction

Auxiliary DACs

The AD9803 includes two 8-bit DACs for controlling any off-chip system functions. These are voltage output DACs with near rail-to-rail output capability. Output voltage levels are programmed through the serial interface. DAC specifications are shown on page 4, and the DAC equivalent output circuit is shown in Figure 14.

AUX-MODE Operation

In addition to the CCD signal-processing path, the AD9803 includes an analog video-processing path. The AUXIN (Pin 34) input consists of an input clamp, PGA, and ADC. Figure 33 shows the Input Configuration of this mode. The recommended value of the external ac-coupling capacitor is 0.1 μ F. The voltage droop with this capacitor value is 20 μ V/ μ s.

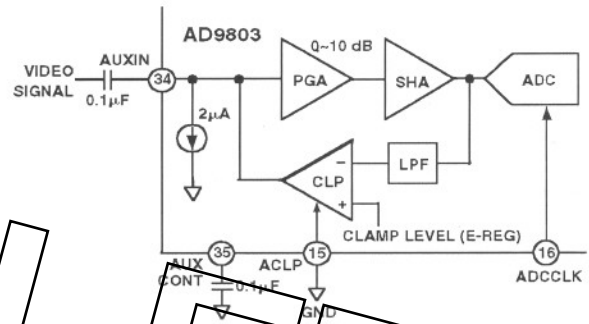

Figure 33. AUX-MODE Circuit Configuration

ADC-MODE Operation

The ADC-MODE of operation is the same as the AUX-MODE, except there is no PGA in the signal path, only the input clamp and ADC. Input specifications and timing for ADC-MODE are the same as those for AUX-MODE. The THD performance is shown in Figure 22.

AD9803

SERIAL INTERFACE SPECIFICATIONS

SDATA SELECT	A0	A1	A2	D0	D1	D2	D3	D4	D5	D6	D7	D8	D9
MODES	1	0	0	e0	e1	d0	d1	c0	c1	b0	b1	a0	a1
PGA	0	1	0	f0	f1	f2	f3	f4	f5	f6	f7	f8	f9
DAC1	1	1	0	g0	g1	g2	g3	g4	g5	g6	g7	X	
DAC2	0	0	1	h0	h1	h2	h3	h4	h5	h6	h7		
MODES2 ¹	1	1	1	m0	0	k0	j0	X					
				OPERATION AND POWER DOWN MODES									

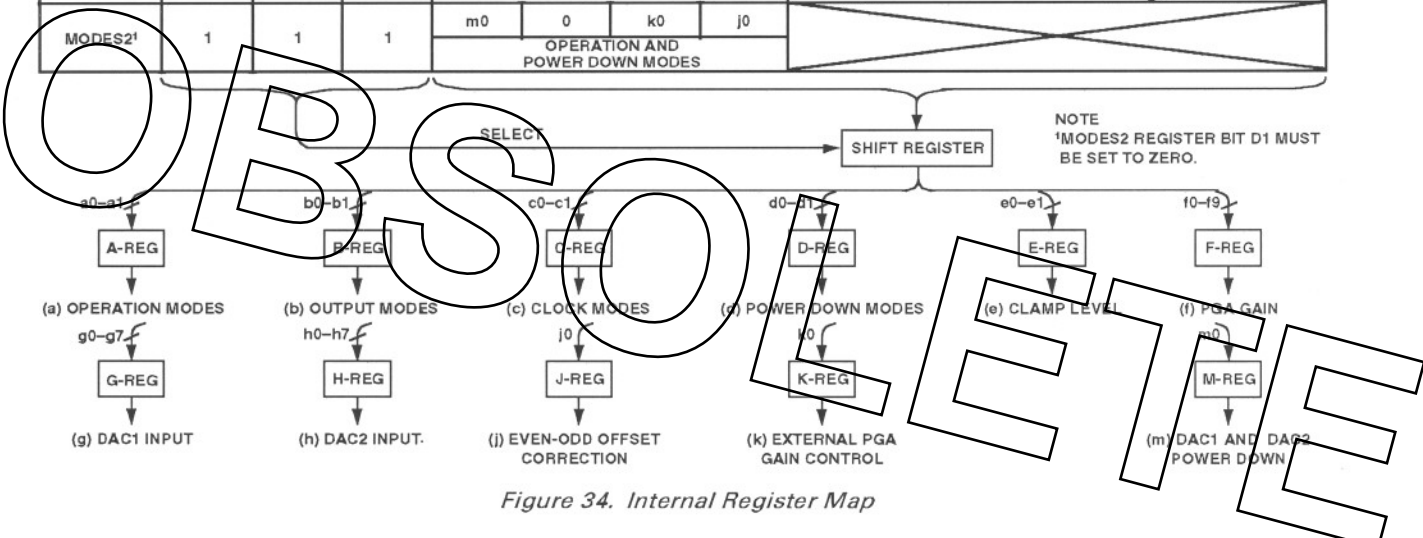

Figure 34. Internal Register Map

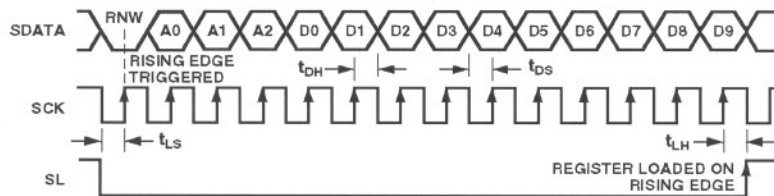

Figure 35. Serial WRITE Operation

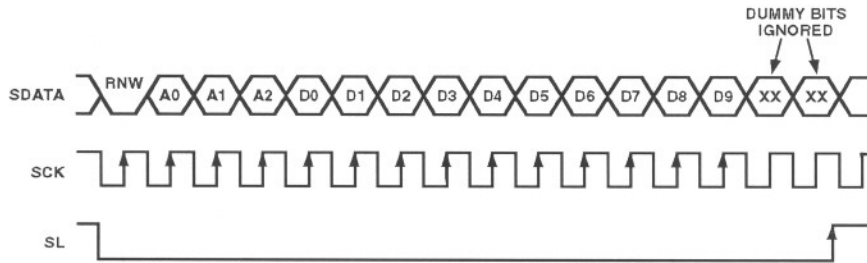

Figure 36. 16-Bit Serial WRITE Operation

AD9803

REGISTER DESCRIPTION

(a) **A-REGISTER: Modes of Operation (Power-On Default Value = 11)**

a1	a0	Modes
0	0	ADC-MODE
0	1	AUX-MODE
1	0	CCD-MODE
1	1	CCD-MODE

(b) **B-REGISTER: Output Modes (Default = 00)**

b1	b0	D9	D8	D7	D6	D5	D4	D3	D2	D1	D0
0	0	Normal									
0	1	0	1	0	1	0	1	0	1	0	1
1	0	1	0	1	0	1	0	1	0	1	0
1	1	High Impedance									

(c) **C-REGISTER: Clock Modes (Default = 00)**

e1	c0	SHP-SHD Clock Pulses	Clamp Active Pulses
0	0	Active Low	Active Low
0	1	Active Low	Active High
1	0	Active High	Active Low
1	1	Active High	Active High

(d) **D-REGISTER: Power-Down Modes (Default = 00)**

Modes	d1	d0	Description
Normal	0	0	Normal Operation
High Speed	0	1	High Speed AUX-MODE
Power-Down 1	1	0	Reference Stand-By (Same Mode as STBY Pin 18)
Power-Down 2	1	1	Total Shut-Down

(e) **E-REGISTER: Clamp Level Selection (Default = 00)**

	e1	e0	Clamp Level
CLP (0)	0	0	32 LSBs
CLP (1)	0	1	48 LSBs
CLP (2)	1	0	64 LSBs
CLP (3)	1	1	16 LSBs

(f) **F-REGISTER: PGA Gain Selection (Default = 00 . . . 0)**

	f9	f8	f7	f6	f5	f4	f3	f2	f1	f0	CCD-Gain
Gain (0)	0	0	0	0	0	0	0	0	0	0	Minimum
Gain (1023)	1	1	1	1	1	1	1	1	1	1	Maximum

(f) **F-REGISTER: PGA Gain Selection (Default = 00 . . . 0)**

	f9	f8	f7	f6	f5	f4	f3	f2	AUX-Gain
Gain (0)	0	0	0	0	0	0	0	0	Minimum
Gain (255)	1	1	1	1	1	1	1	1	Maximum

(g) **G-REGISTER: DAC1 Input (Default = 00 . . . 0)**

	g7	g6	g5	g4	g3	g2	g1	g0	DAC1 Output
Code (0)	0	0	0	0	0	0	0	0	Minimum
Code (255)	1	1	1	1	1	1	1	1	Maximum

(h) **H-REGISTER: DAC2 Input (Default = 00 . . . 0)**

	h7	h6	h5	h4	h3	h2	h1	h0	DAC2 Output
Code (0)	0	0	0	0	0	0	0	0	Minimum
Code (255)	1	1	1	1	1	1	1	1	Maximum

(j) **J-REGISTER: Even-Odd Offset Correction (Default = 0)**

j0	Even-Odd Offset Correction
0	Offset Correction In Use
1	Offset Correction Not Used

(k) **K-REGISTER: External PGA Gain Control (Default = 0)**

k0	PGA Gain Control
0	External Voltage Control Through AUXCONT or PGACONT1 and PGACONT2
1	Internal 10-Bit DAC Control of PGA Gain

(m) **M-REGISTER: DAC1 & DAC2 pdn (Default = 0)**

m0	Power-Down of 8-Bit DACs
0	8-Bit DACs Powered-Down
1	8-Bit DACs Operational

AD9803

NOTE: With the exception of a write to the PGA register during AUX-mode, all data writes must be 10 bits. During an AUX-mode write to the PGA register, only 8 bits of data are required. If more than 14 SCK rising edges are applied during a write operation, additional SCK pulses will be ignored (see Figure 35). All reads must be 10 bits to receive valid register contents. All registers default to 0s on power-up, except for the A-register which defaults to 11. Thus, on power-up, the AD9803 defaults to CCD mode. During the power-up phase, it is recommended that SL be HIGH and SCK be LOW to prevent accidental register write operations. SDATA may be unknown. The RNW bit ("Read/Not Write") must be LOW for all write operations to the serial interface, and HIGH when reading back from the serial interface registers.

APPLICATIONS INFORMATION

Power and Grounding Recommendations

The AD9803 should be treated as an analog component when used in a system. The same power supply and ground plane should be used for all of the pins. In a two-ground system, this requires that the digital supply pins be decoupled to the analog ground plane and the digital ground pins be connected to analog ground for best noise performance. Separate digital supplies can be used, particularly if slightly different driver supplies are needed, but the digital power pins should still be decoupled to the same point as the digital ground pins (the analog ground plane). If the AD9803 digital outputs need to drive a bus or substantial load, then a buffer should be used at the AD9803's outputs, with the buffer referenced to system digital ground. In some cases, when system digital noise is not substantial, it is acceptable to split the ground pins on the AD9803 to separate analog and digital ground planes. If this is done, be sure to connect the two ground planes together at the AD9803.

To further improve performance, isolating the driver supply DRVDD from DVDD with a ferrite bead can help reduce kickback effects during major code transitions. Alternatively, the use of damping resistors on the digital outputs will reduce the output rise times, also reducing the kickback effect.

Application Circuit Utilizing the AD9803's Digital Gain Control
 Figure 37 shows the recommended circuit configuration for CCD-Mode operation when using the 3-wire serial interface. The analog PGA control pins, PGACONT1 and PGACONT2, should be shorted together and decoupled to ground. If the two auxiliary DACs are not used, then Pins 39 and 40 (DAC1 and DAC2) may be grounded.

Using the AD9803 in AD9801 Sockets

The AD9803 may be easily used in existing AD9801 designs without any circuit modifications. Most of the pin assignments are the same for both ICs. Table I outlines the differences. The circuit of Figure 38 shows the necessary connections for the AD9803 when used in an existing AD9801 socket. The power-on reset in the AD9803 assures that the device will power-up in CCD-mode, with analog PGA gain control.

Table I. AD9801/AD9803 Pin Differences

Pin No.	AD9801	AD9803	AD9801 Connection
1	ADVSS	NC	Ground
14	DSUBST	DVSS	Ground
15	DVSS	ACL P	Ground
24	DVSS	NC	Ground
32	CLAMP_BIAS	CLPBYP	Decoupled with 0.1 μ F to Ground
34	ACVDD	AUXIN	+3 Volt Supply
35	ACVDD	AUXCONT	+3 Volt Supply
36	INT_BIAS1	ADCIN	Decoupled with 0.1 μ F to Ground
38	INT_BIAS2	VTRBYP	Decoupled with 0.1 μ F to Ground
39	MODE2	DAC1	Ground
40	MODE1	DAC2	Ground
41	ADVSS	SL	Ground
42	ADVDD	SCK	+3 Volt Supply
44	ADVSS	SDATA	Ground

AD9803

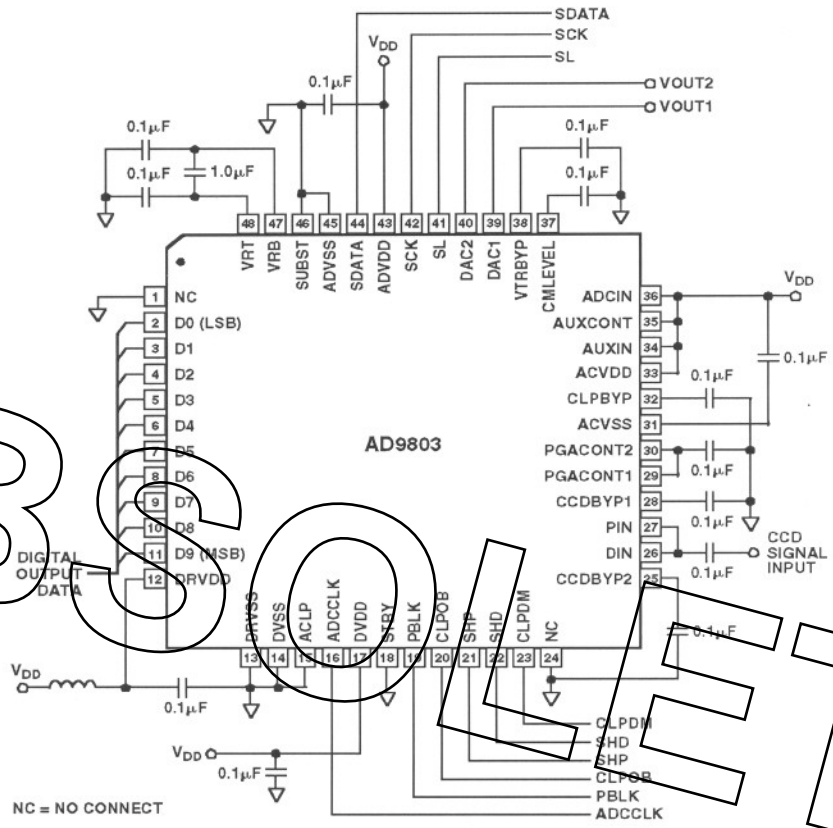

Figure 37. CCD-Mode Circuit Configuration—Digital PGA Control

OBSOLETE

AD9803

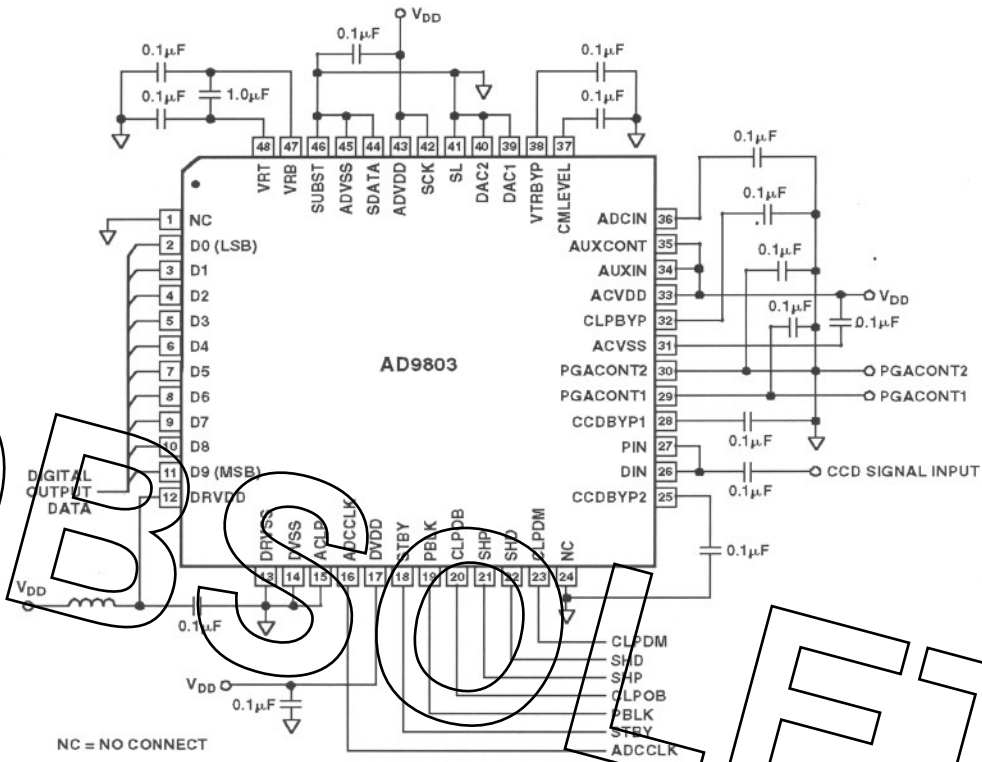

Figure 38. Recommended Circuit for AD9801 Sockets

AD9803

OUTLINE DIMENSIONS

Dimensions shown in inches and (mm).

**48-Lead Plastic Thin Quad Flatpack (LQFP)
(ST-48)**

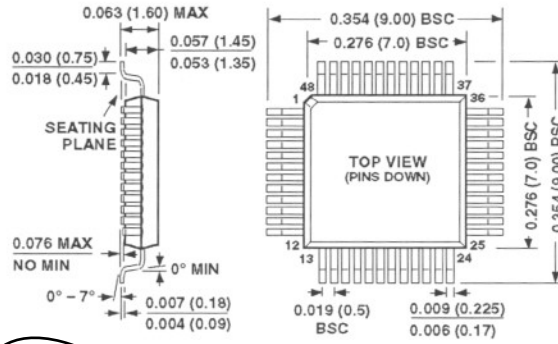

OBSOLETE