

**SPECIFICATIONS** **CS126AW2C**

**PACKAGE OUTLINES**

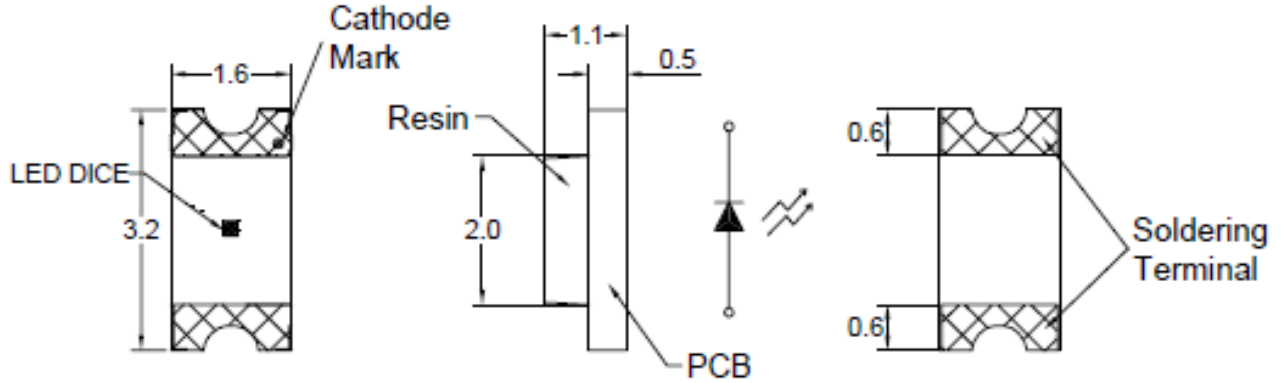

- Notes:
1. All dimensions are in millimeters (inches);
  2. Tolerances are  $\pm 0.1$ mm unless otherwise noted.

**Recommended Solder Pad**

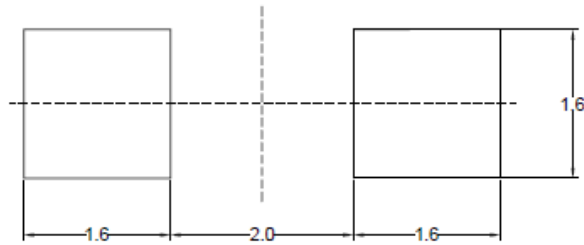

Note : The tolerances unless mentioned is  $\pm 0.1$ mm, Angle  $\pm 0.5$ . Unit=mm.

Part Number	Chip Material	Color of Emission	Lens Type	Viewing Angle
CS126AW2C	InGaN/GaN	White	Yellow Diffused	160°



ChromeLED Corp. reserves the right to make changes at any time in order to supply the best product possible. The most current version of this document will always be available at: [www.chromeled.com](http://www.chromeled.com)

**ABSOLUTE MAXIMUM RATINGS**
**(TA=25°C)**

Parameter	Symbol	Value	Unit
Forward current	I <sub>f</sub>	20	mA
Reverse current @ 5V	I <sub>r</sub>	50	μA
Power dissipation	P <sub>d</sub>	80	mW
Operating temperature range	T <sub>opr</sub>	-40~+85	°C
Storage temperature range	T <sub>stg</sub>	-40~+90	°C
Peak pulsing current (1/10 duty f= 10KHz)	I <sub>fp</sub>	100	mA
Soldering Temperature	T <sub>SOL</sub>	Max 260°C for 5 sec Max	

**OPTICAL-ELECTRICAL CHARACTERISTICS**
**(TA=25°C)**

Parameter	Symbol	Test Condition	Value			Unit
			Min	Typ	Max	
Chromaticity Coordinates	X	I <sub>F</sub> = 20mA	0.21	-	0.35	
	Y	I <sub>F</sub> = 20mA	.015	-	0.4	
Spectral half bandwidth	Δλ	I <sub>F</sub> = 20mA	-	30	-	nm
Forward Voltage	V <sub>f</sub>	I <sub>F</sub> = 20mA	-	3.5	4.0	V
Luminous intensity	I <sub>v</sub>	I <sub>F</sub> = 20mA	125	320	-	mcd
Viewing angle at 50% I <sub>v</sub>	2Θ ½	I <sub>F</sub> = 20mA	-	160		Deg

\*NOTE: 1. The forward voltage data did not including ±0.1V tolerance 2. The luminous intensity data did not including ±15% tolerance



ChromeLED Corp. reserves the right to make changes at any time in order to supply the best product possible. The most current version of this document will always be available at: [www.chromeled.com](http://www.chromeled.com)

## DIMENSIONS OF TAPE (Unit: mm)

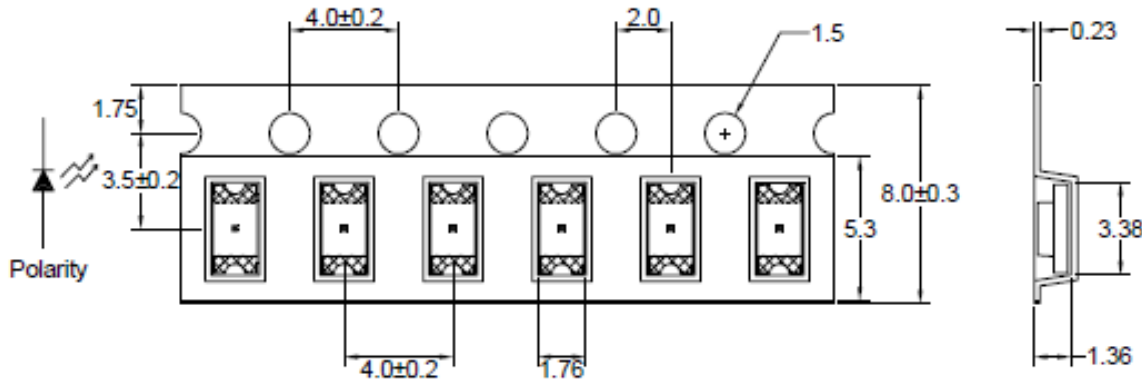

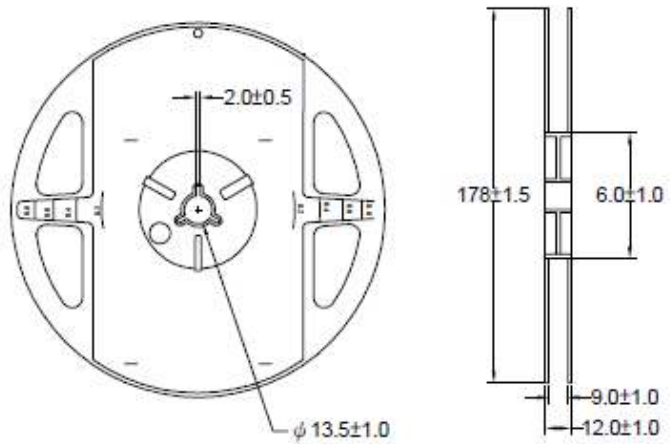

NOTE: The tolerances unless mentioned is  $\pm 0.1$ mm, Angle  $\pm 0.5$ . Unit = mm.

## REEL DIMENSIONS

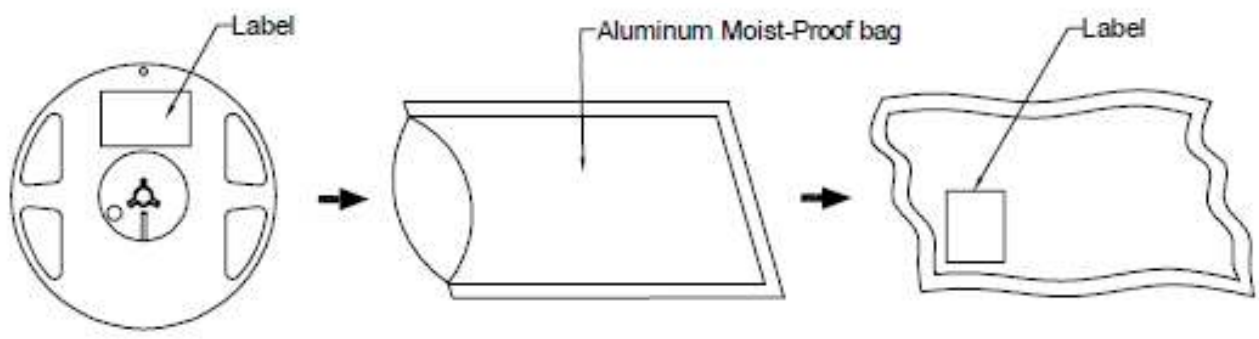

- NOTES:
1. Empty component pockets are sealed with top cover tape;
  2. The maximum number of missing lamps is two;
  3. The cathode is oriented towards the tape sprocket hole.
  4. 3,000pcs/Reel

## PACKAGING SPECIFICATION

ChromeLED Corp. reserves the right to make changes at any time in order to supply the best product possible. The most current version of this document will always be available at: [www.chromeled.com](http://www.chromeled.com)

## OPTICAL CHARACTERISTIC CURVES

Fig.1 Forward current vs. Forward Voltage

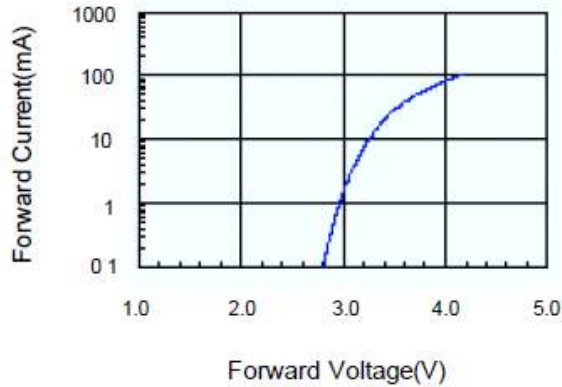

Fig.2 Relative Intensity vs. Forward Current

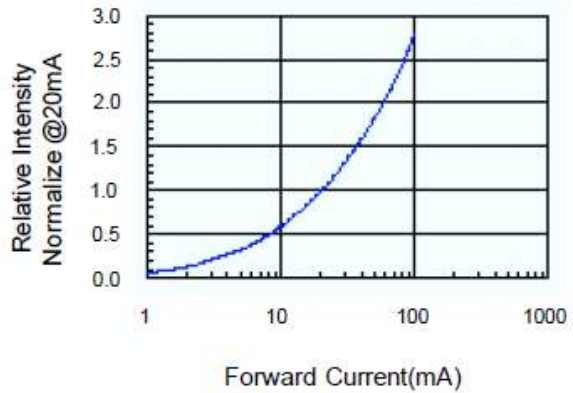

Fig.3 Forward Voltage vs. Temperature

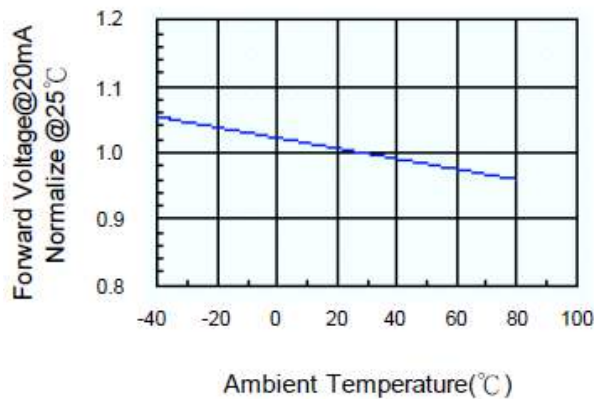

Fig.4 Relative Intensity vs. Temperature

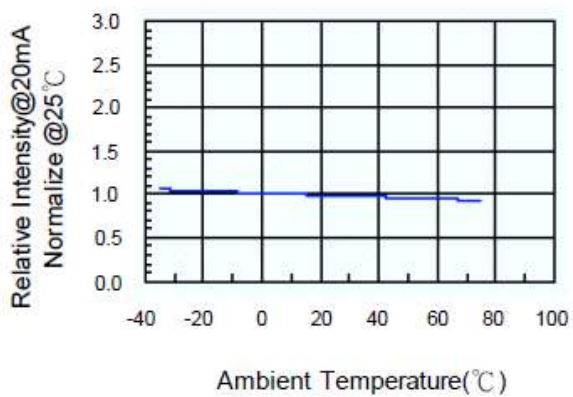

Fig.5 Luminous Spectrum (Ta=25°C)

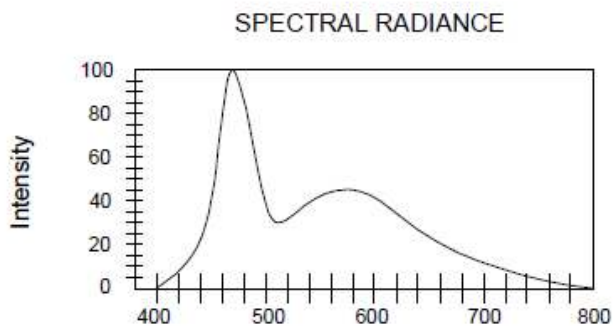
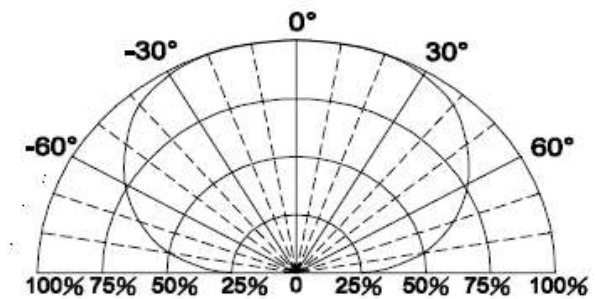

Fig.6 Directive Radiation



ChromeLED Corp. reserves the right to make changes at any time in order to supply the best product possible. The most current version of this document will always be available at: [www.chromeled.com](http://www.chromeled.com)

**CHROMATICITY COORDINATES SPECIFICATIONS FOR BIN GRADING**

BIN	X	Y	BIN	X	Y	BIN	X	Y
A1	0.21	0.190	B1	0.26	0.265	C1	0.31	0.340
	0.21	0.150		0.26	0.225		0.31	0.300
	0.22	0.165		0.27	0.240		0.32	0.315
	0.22	0.205		0.27	0.280		0.32	0.355
A2	0.22	0.205	B2	0.27	0.280	C2	0.32	0.355
	0.22	0.165		0.27	0.240		0.32	0.315
	0.23	0.180		0.28	0.255		0.33	0.330
	0.23	0.220		0.28	0.295		0.33	0.370
A3	0.23	0.220	B3	0.28	0.295	C3	0.33	0.370
	0.23	0.180		0.28	0.255		0.33	0.330
	0.24	0.195		0.29	0.270		0.34	0.345
	0.24	0.235		0.29	0.310		0.34	0.385
A4	0.24	0.235	B4	0.29	0.310	C4	0.34	0.385
	0.24	0.195		0.29	0.270		0.34	0.345
	0.25	0.210		0.30	0.285		0.35	0.360
	0.25	0.250		0.30	0.325		0.35	0.400
A5	0.25	0.250	B5	0.30	0.325			
	0.25	0.210		0.30	0.285			
	0.26	0.225		0.31	0.300			
	0.26	0.265		0.31	0.340			



ChromeLED Corp. reserves the right to make changes at any time in order to supply the best product possible. The most current version of this document will always be available at: [www.chromeled.com](http://www.chromeled.com)

## SOLDERING CONDITIONS – LAMP TYPE LED

### 1. Hand Solder

Basic spec is  $\leq 280^{\circ}\text{C}$  3 sec one time only.

### 2. Wave Solder

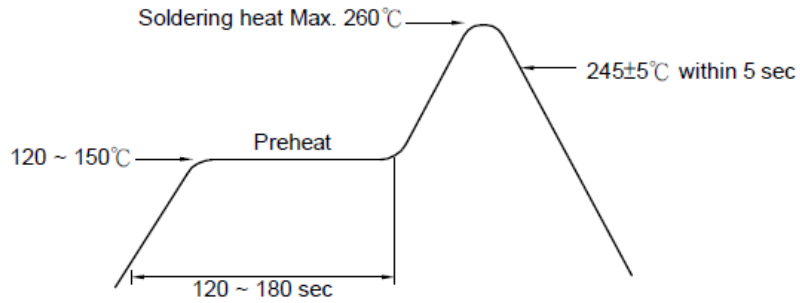

### 3-1. LEAD Reflow Solder

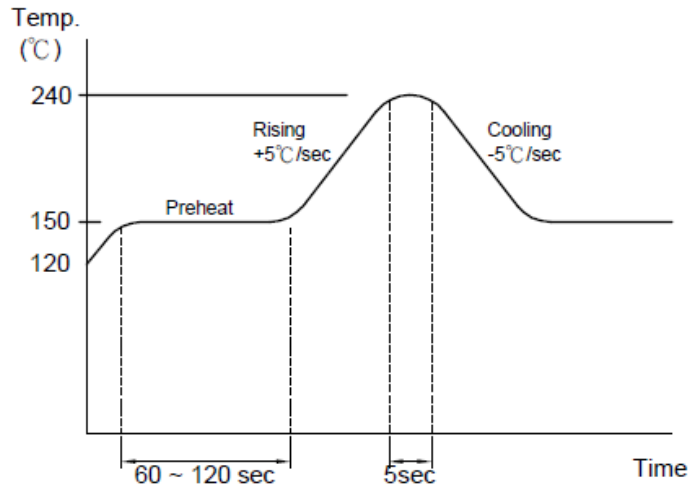

### 3-2 PB-Free Reflow Solder

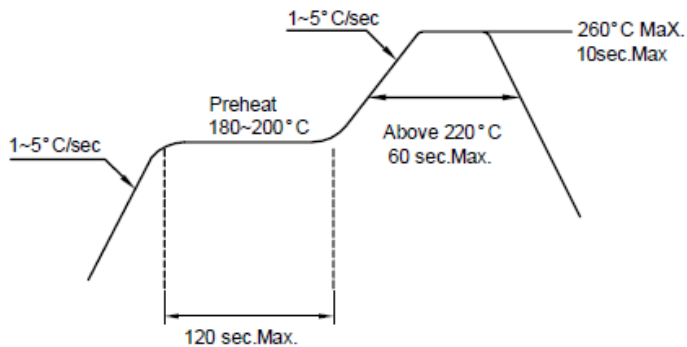

Reflow Soldering should not be done more than two times.



ChromeLED Corp. reserves the right to make changes at any time in order to supply the best product possible. The most current version of this document will always be available at: [www.chromeled.com](http://www.chromeled.com)