

A Wide Variety of DIN Connectors That Conform to UL/CSA Standards.

- Fully preserve the characteristics of normal DIN connectors while increasing the number of terminals available.
- A wide product range to fit almost any application.
- Meeting world market needs with products ranging from one-piece connectors (card edge) to two-piece connectors.
- Use the twin-contact system for high reliability.
- Lower insertion force as a result of FEM analysis techniques.
- See the "Standards certification / conformity list" for information on conformity to certification standards.

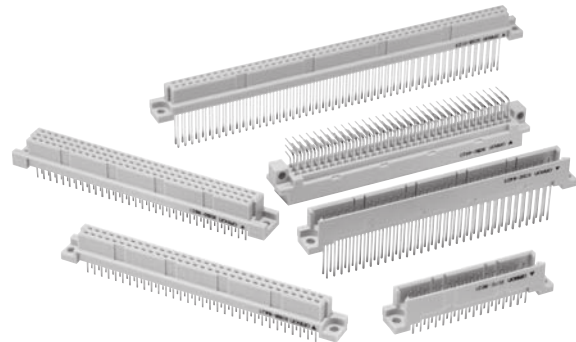

RoHS Compliant

■ Ratings and Characteristics

Rated current	2 A
Rated voltage	300 VAC
Contact resistance	20 mΩ max. (at 20 mV, 100 mA max.)
Insulation resistance	10 ⁶ MΩ min. (at 100 VDC)
Dielectric strength	1,000 VAC for 1 min (leakage current: 1 mA max.)
Total insertion force	0.59 N max. per contact
Removal force	0.15 N min. (with test gauge, t = 0.56 mm)
Insertion durability	200 times
Ambient operating temperature	-55 to 125°C (with no icing at low temperature)

■ Materials and Finish

Item		Plugs (See note 2.)	Sockets
Housings		Fiber-glass reinforced PBT resin (UL94 V-0)/gray	
Contacts	Mating end	Brass/nickel base, 0.4-μm gold plating (See note 1.)	Phosphor bronze/nickel base, 0.4-μm gold plating (See note 1.)
	Terminal	Brass/nickel base, 2.0-μm tin plating	Phosphor bronze/nickel base, 2.0-μm tin plating

- Note:**
1. For non-standard plating specifications, contact your OMRON representative.
 2. Wrap terminal contacts are made from phosphor bronze.

■ Applicable Wrap Post Wire Sizes

AWG30, AWG28, AWG26, or AWG24
(Solid wire: 0.25 to 0.51 mm dia.)

■ Wrap Post Length

3 wires

XC5A Double-row Plugs, DIN B-type (Standard)

■ Dimensions

(unit: mm)

XC5A-□□22

(With right-angle DIP terminals)

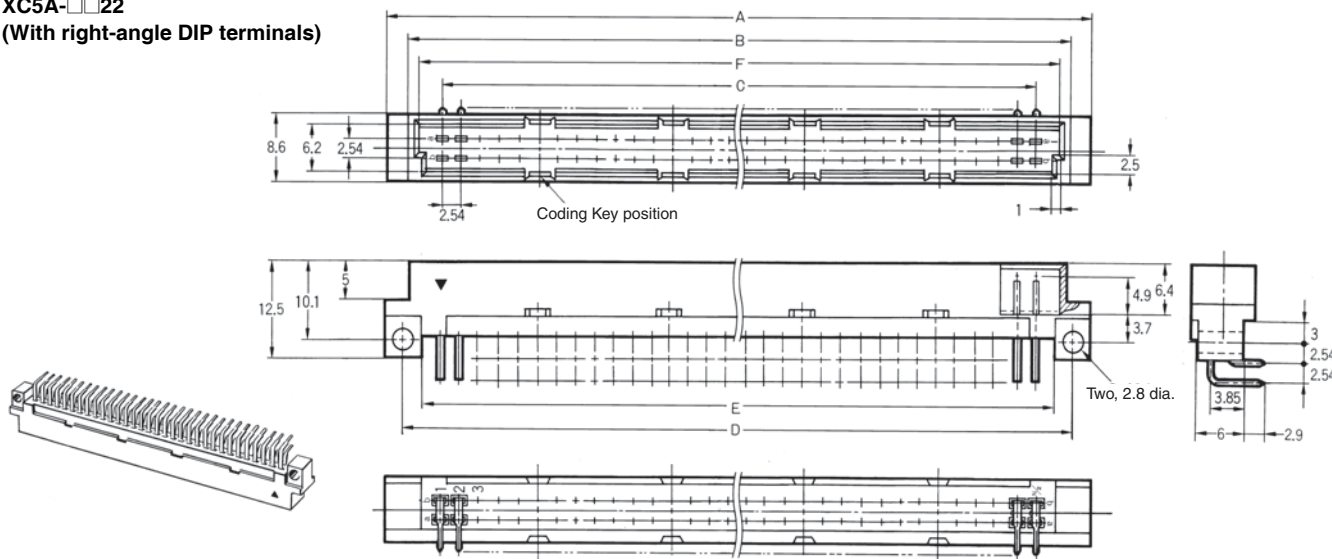

XC5A
DIP terminal cross-section view

Mounting holes (bottom view)

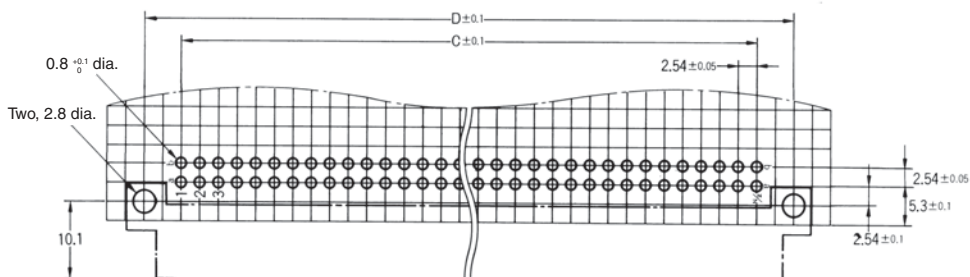
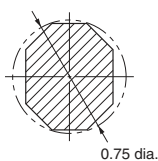

Dimensions

No. of contacts	Dimensions (mm)						Coding Key positions (contact No.)
	A	B	C	D	E	F	
20	37.9	32.1	22.86	33.02	28.1	29.3	3, 8
32	53.2	47.4	38.10	48.26	43.3	44.6	5, 12
44	68.4	62.6	53.34	63.50	58.5	59.8	4, 9, 14, 19
50	76.0	70.2	60.96	71.12	66.2	67.4	5, 10, 16, 21
64	93.8	88.0	78.74	88.90	83.9	85.2	6, 13, 20, 27
100	139.5	133.7	124.46	134.62	129.7	130.9	10, 20, 31, 41

■ Ordering Information

No. of contacts	Terminal type	Model
20*	Right-angle DIP terminals	XC5A-2022
32		XC5A-3222
44*		XC5A-4422
50*		XC5A-5022
64		XC5A-6422
100*		XC5A-0122

*Marked items have an increased number of contacts while following DIN standards.

XC5B Double-row Sockets, DIN B-type (Standard)

■ Dimensions

(unit: mm)

XC5B-□□21
(With straight DIP terminals)

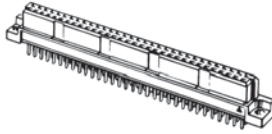

XC5B
DIP terminal cross-section view

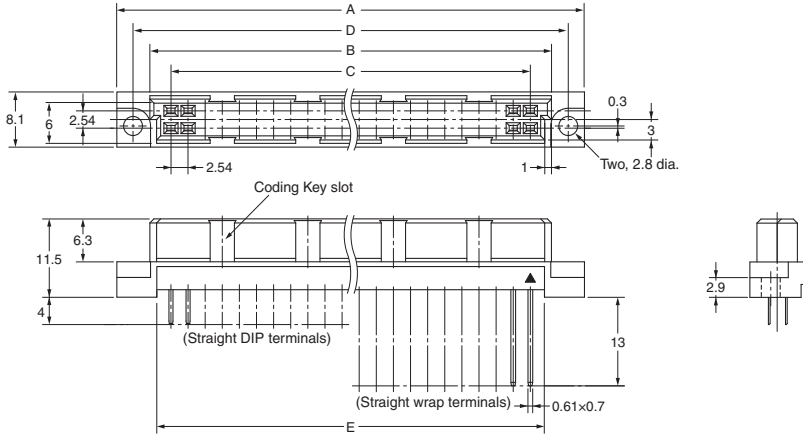
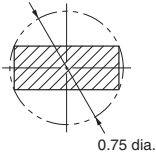

XC5B-□□23
(With straight wrap terminals)

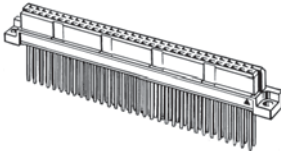

XC5B
Wrap terminal cross-section view

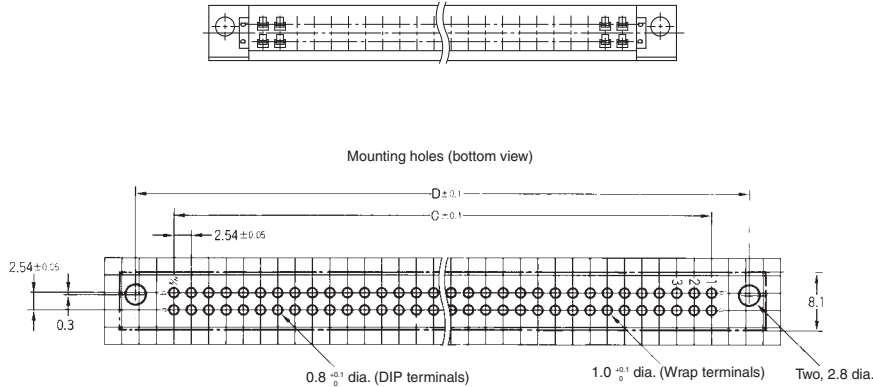
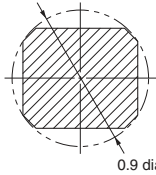

Dimensions

No. of contacts	Dimensions (mm)					Coding Key slot positions (contact No.)
	A	B	C	D	E	
20	38.9	29.1	22.86	34.12	27.1	3, 8
32	54.2	44.4	38.10	49.36	42.3	5, 12
44	69.4	59.6	53.34	64.60	57.5	4, 9, 14, 19
50	77.0	67.2	60.96	72.22	65.2	5, 10, 16, 21
64	94.8	85.0	78.74	90.00	82.9	6, 13, 20, 27
100	140.5	130.7	124.46	135.72	128.7	10, 20, 31, 41

■ Ordering Information

No. of contacts	Straight DIP terminals	Straight wrap terminals
	Model	Model
20*	XC5B-2021	XC5B-2023
32	XC5B-3221	XC5B-3223
44*	XC5B-4421	XC5B-4423
50*	XC5B-5021	XC5B-5023
64	XC5B-6421	XC5B-6423
100*	XC5B-0121	XC5B-0123

*Marked items have an increased number of contacts while following DIN standards.

XC5E Double-row Plugs, DIN Q-type (Reverse)

■ Dimensions

(unit: mm)

XC5E-□□21

(With straight DIP terminals)

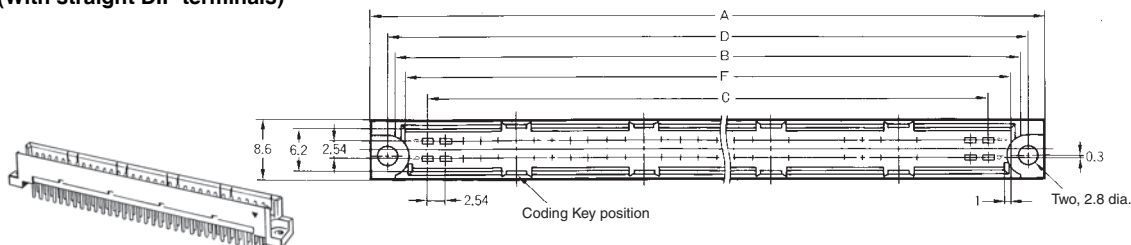

XC5E
DIP terminal cross-section
view

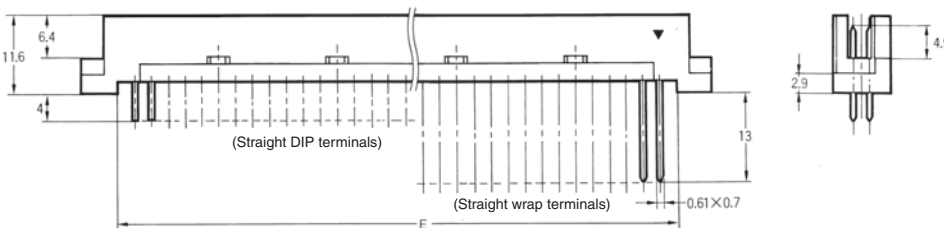

XC5E-□□23

(With straight wrap terminals)

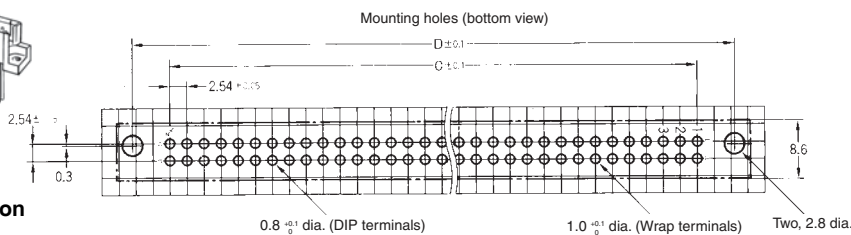
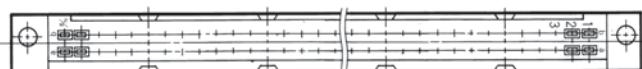
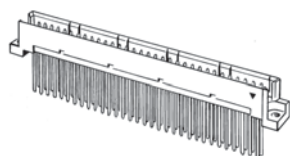

XC5E
Wrap terminal cross-section
view

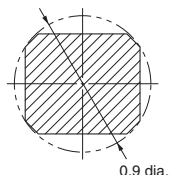

Dimensions

No. of contacts	Dimensions (mm)						Coding Key positions (contact No.)
	A	B	C	D	E	F	
20	38.9	32.1	22.86	34.12	28.1	29.3	3, 8
32	54.2	47.4	38.10	49.36	43.3	44.6	5, 12
44	69.4	62.6	53.34	64.60	58.5	59.8	4, 9, 14, 19
50	77.0	70.2	60.96	72.22	66.2	67.4	5, 10, 16, 21
64	94.8	88.0	78.74	90.00	83.9	85.2	6, 13, 20, 27
100	140.5	133.7	124.46	135.72	129.7	130.9	10, 20, 31, 41

■ Ordering Information

No. of contacts	Straight DIP terminals	Straight wrap terminals
	Model	Model
20*	XC5E-2021	XC5E-2023
32	XC5E-3221	XC5E-3223
44*	XC5E-4421	XC5E-4423
50*	XC5E-5021	XC5E-5023
64	XC5E-6421	XC5E-6423
100*	XC5E-0121	XC5E-0123

*Marked items have an increased number of contacts while following DIN standards.

XC5F Double-row Sockets, DIN Q-type (Reverse)

■ Dimensions

(unit: mm)

XC5F-□□22
(With right-angle DIP terminals)

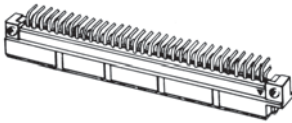
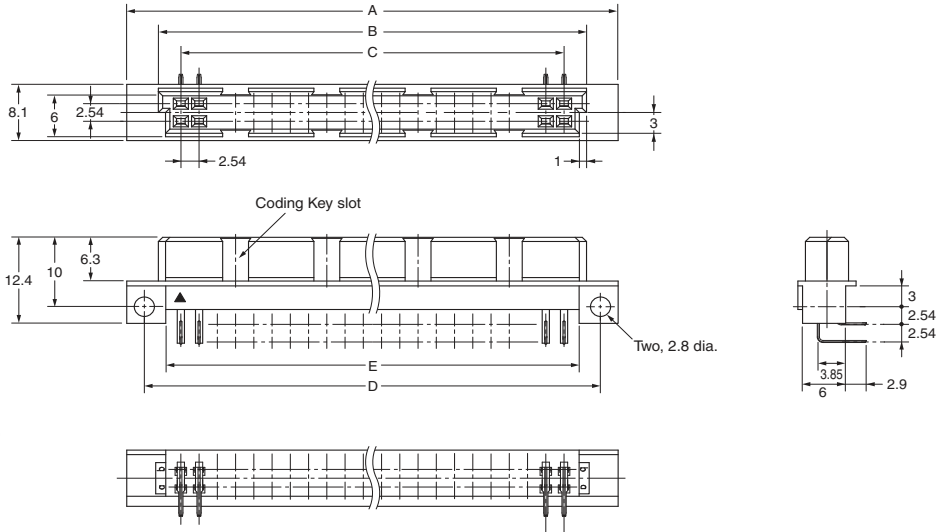

XC5F
DIP terminal cross-section view

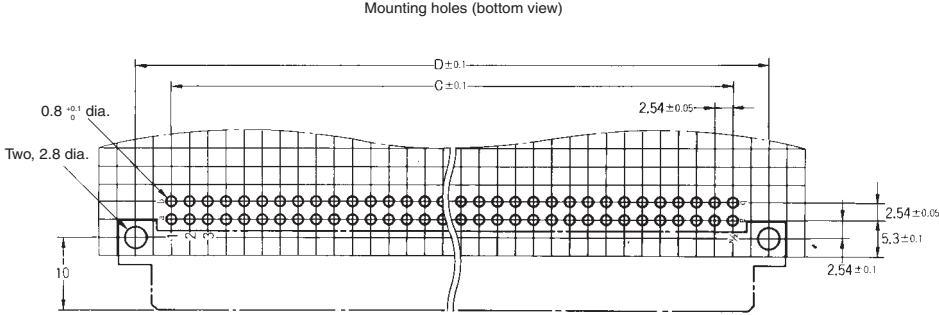
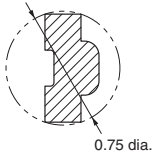

Dimensions

No. of contacts	Dimensions (mm)					Coding Key slot positions (contact No.)
	A	B	C	D	E	
20	37.9	29.1	22.86	33.02	27.1	3, 8
32	53.2	44.4	38.10	48.26	42.3	5, 12
44	68.4	59.6	53.34	63.50	57.5	4, 9, 14, 19
50	76.0	67.2	60.96	71.12	65.2	5, 10, 16, 21
64	93.8	85.0	78.74	88.90	82.9	6, 13, 20, 27
100	139.5	130.7	124.46	134.62	128.7	10, 20, 31, 41

■ Ordering Information

No. of contacts	Terminal type	Model
20*	Right-angle DIP terminals	XC5F-2022
32		XC5F-3222
44*		XC5F-4422
50*		XC5F-5022
64		XC5F-6422
100*		XC5F-0122

*Marked items have an increased number of contacts while following DIN standards.

XC5C Triple-row Plugs, DIN C-type (Standard)

■ Dimensions

(unit: mm)

XC5C-□□22
(With right-angle DIP terminals)

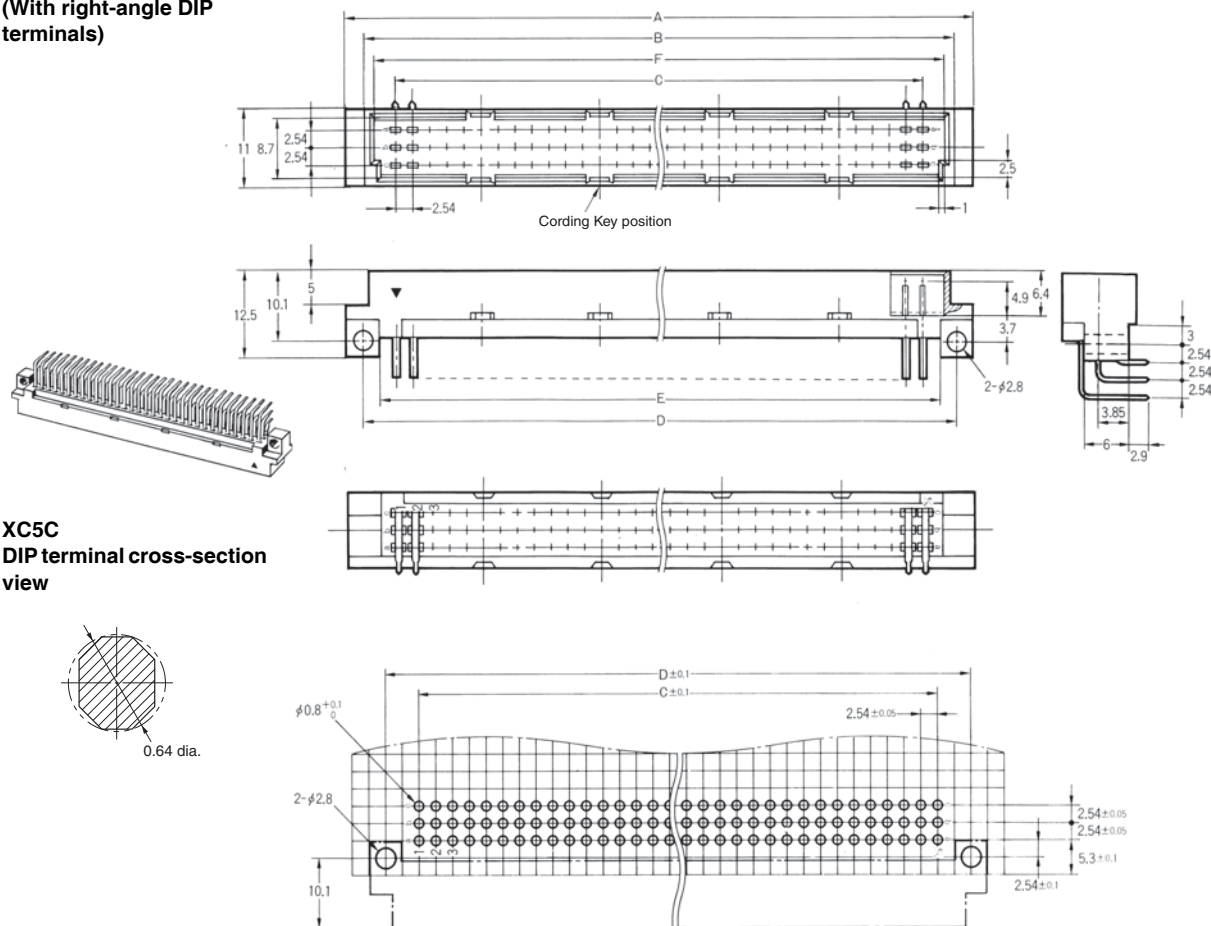

Dimensions

No. of contacts	Dimensions (mm)						Coding Key positions (contact No.)
	A	B	C	D	E	F	
32*	53.2	47.4	38.10	48.26	43.3	44.6	5, 12
48	53.2	47.4	38.10	48.26	43.3	44.6	5, 12
64*	93.8	88.0	78.74	88.90	83.9	85.2	6, 13, 20, 27
96	93.8	88.0	78.74	88.90	83.9	85.2	6, 13, 20, 27

*Has no center row (row b).

■ Ordering Information

No. of contacts	Terminal type	Model
32*	Right-angle DIP terminals	XC5C-3222
48		XC5C-4822
64*		XC5C-6422
96		XC5C-9622

*Has no center row (row b).

XC5D Triple-row Sockets, DIN C-type (Standard)

■ Dimensions

(unit: mm)

XC5D-□□21

(With straight DIP terminals)

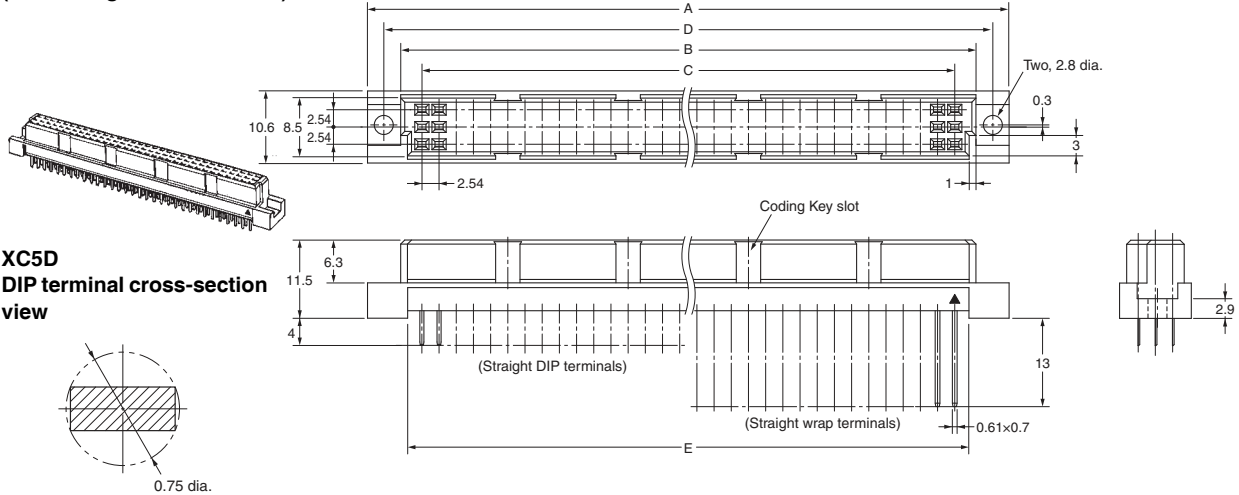

XC5D
DIP terminal cross-section
view

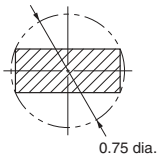

XC5D-□□23

(With straight wrap terminals)

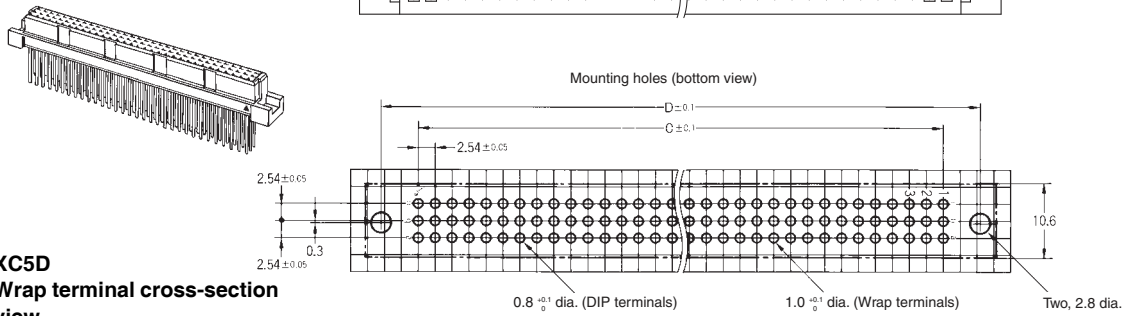

XC5D
Wrap terminal cross-section
view

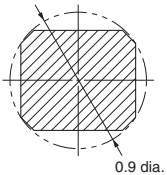

Dimensions

No. of contacts	Dimensions (mm)					Coding Key slot positions (contact No.)
	A	B	C	D	E	
32*	54.2	44.4	38.10	49.36	42.3	5, 12
48	54.2	44.4	38.10	49.36	42.3	5, 12
64*	94.8	85.0	78.74	90.00	82.9	6, 13, 20, 27
96	94.8	85.0	78.74	90.00	82.9	6, 13, 20, 27

*Has no center row (row b).

■ Ordering Information

No. of contacts	Straight DIP terminals	Straight wrap terminals
	Model	Model
32*	XC5D-3221	---
48	XC5D-4821	XC5D-4823
64*	XC5D-6421	XC5D-6423
96	XC5D-9621	XC5D-9623

*Has no center row (row b).

XC5G Triple-row Plugs, DIN R-type (Reverse)

■ Dimensions

(unit: mm)

XC5G-□□21
(With straight DIP terminals)

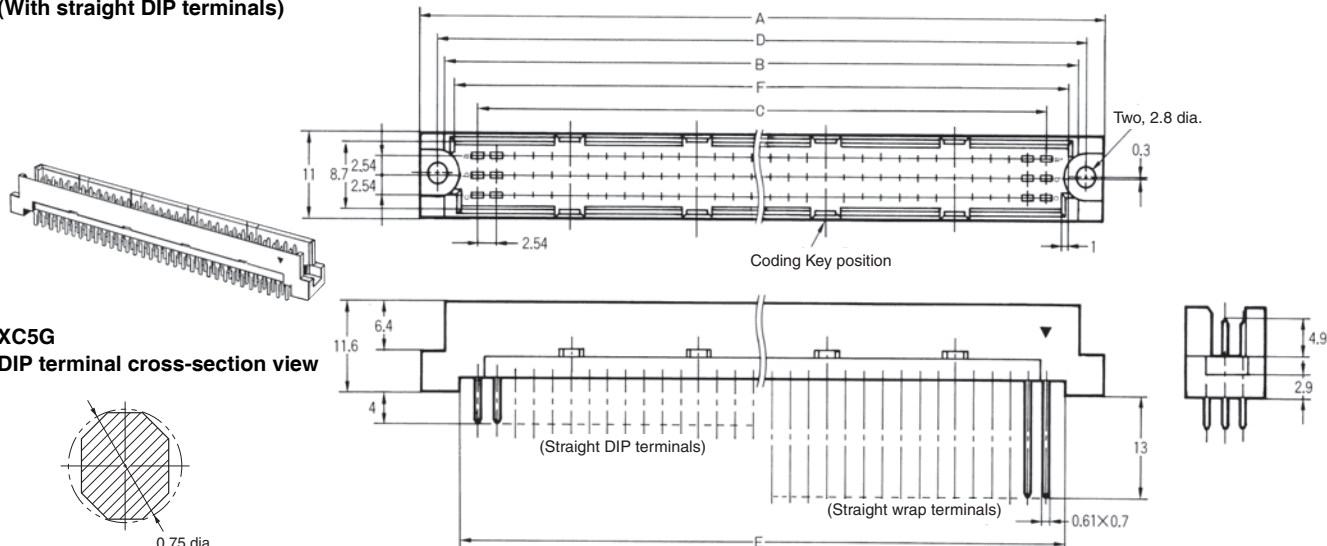

XC5G
DIP terminal cross-section view

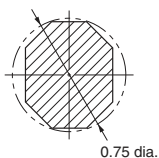

XC5D-□□23
(With straight wrap terminals)

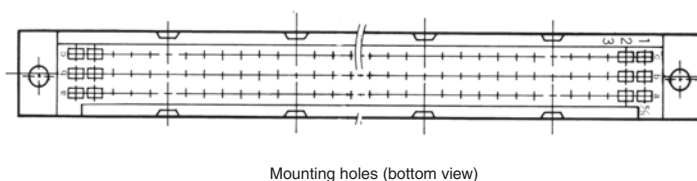
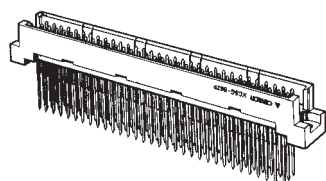

XC5G
Wrap terminal cross-section view

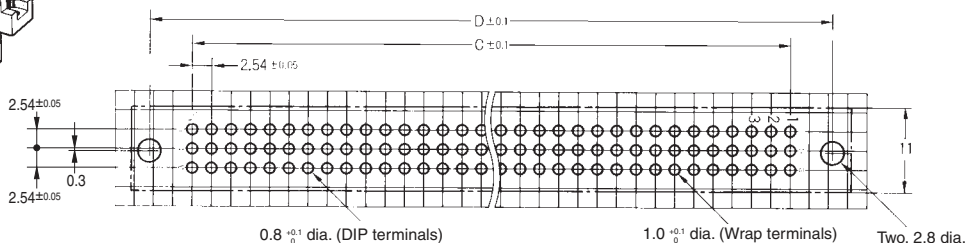
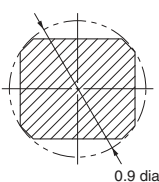

Dimensions

No. of contacts	Dimensions (mm)						Coding Key positions (contact No.)
	A	B	C	D	E	F	
48	54.2	47.4	38.10	49.36	43.3	44.6	5, 12
64*	94.8	88.0	78.74	90.00	83.9	85.2	6, 13, 20, 27
96	94.8	88.0	78.74	90.00	83.9	85.2	6, 13, 20, 27

*Has no center row (row b).

■ Ordering Information

No. of contacts	Straight DIP terminals	Straight wrap terminals
	Model	Model
48	XC5G-4821	XC5G-4823
64*	XC5G-6421	XC5G-6423
96	XC5G-9621	XC5G-9623

*Has no center row (row b).

XC5H Triple-row Sockets, DIN R-type (Reverse)

■ Dimensions

(unit: mm)

XC5H-□□22
(With right-angle DIP terminals)

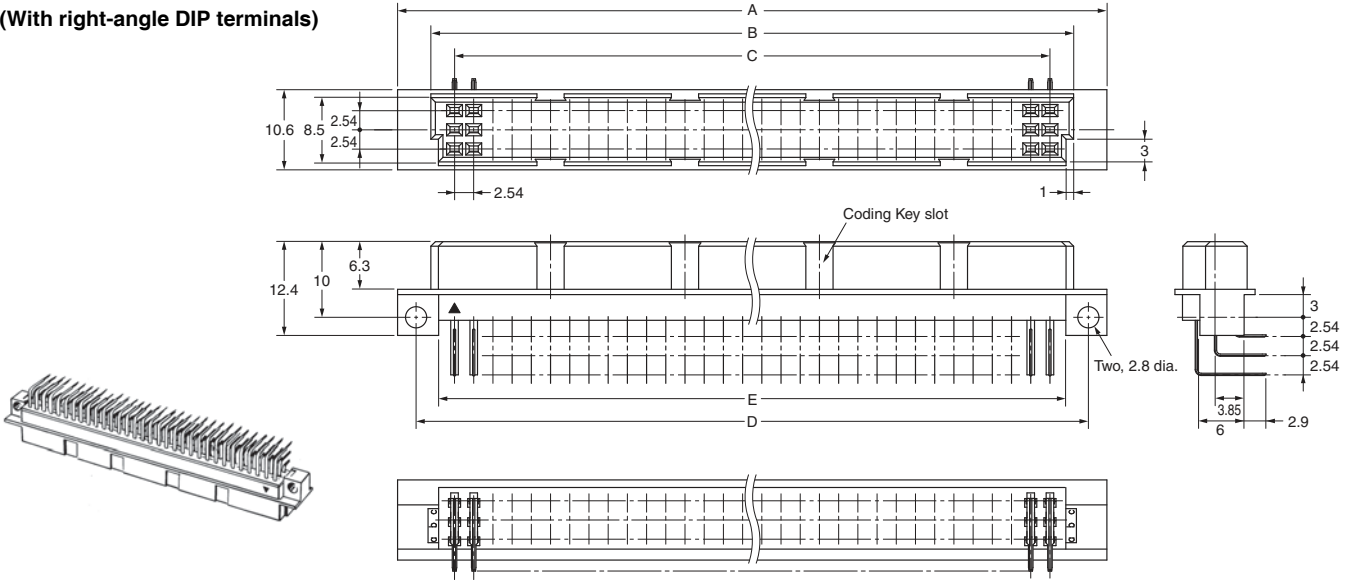

XC5H
DIP terminal cross-section view

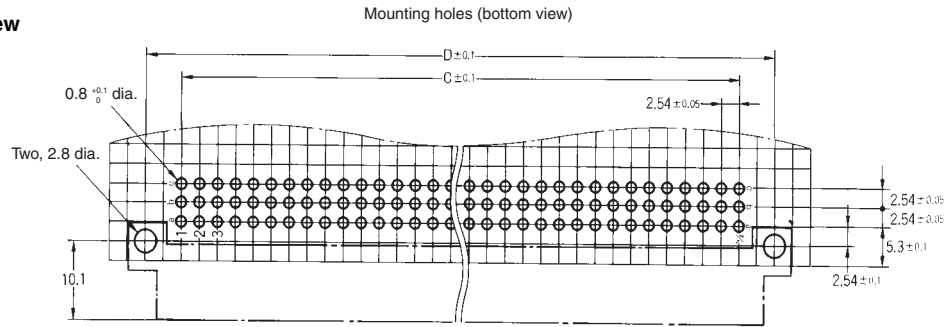
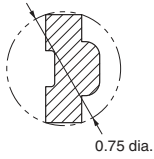

Dimensions

No. of contacts	Dimensions (mm)					Coding Key slot positions (contact No.)
	A	B	C	D	E	
48	53.2	44.4	38.10	48.26	42.3	5, 12
64*	93.8	85.0	78.74	88.90	82.9	6, 13, 20, 27
96	93.8	85.0	78.74	88.90	82.9	6, 13, 20, 27

*Has no center row (row b).

■ Ordering Information

No. of contacts	Terminal type	Model
48	Right-angle DIP terminals	XC5H-4822
64*		XC5H-6422
96		XC5H-9622

*Has no center row (row b).

Tools and Accessories (Sold Separately)

Coding Cutter XY2D-0001

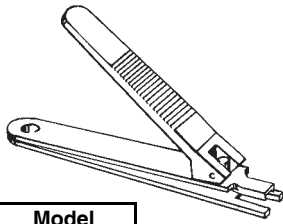

Model
XY2D-0001

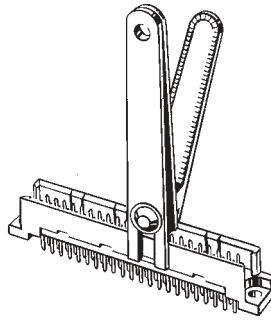

1. Cut the Coding Key(s) in the slot in the plug housing wall with the special cutting tool (XY2D-0001).

Note: Coding Cutters may not work with some DIN-style connector combinations. In that case, contact your OMRON representative.

Coding Key XC5Z-0001

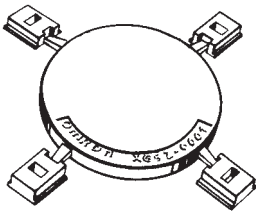

Material: PBT resin (UL94HB)/white

Model
XC5Z-0001

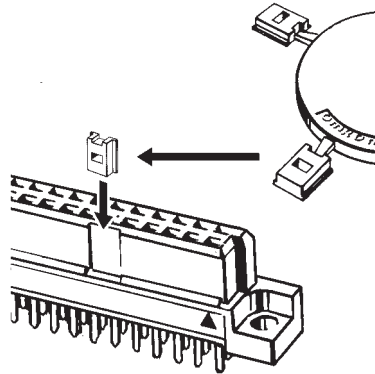

2. Insert the special Coding Key (XC5Z-0001) into the Coding Key slots in the housing wall of the corresponding Socket.

Note: 1. Each XC5Z-0001 has four Coding Keys.

2. Coding Keys may not work with some DIN-style connector combinations. In that case, contact your OMRON representative.

Temporary Fastening Pins XC5Z-0002

(For use with 1.6-mm boards)



Material: stainless steel

Model
XC5Z-0002

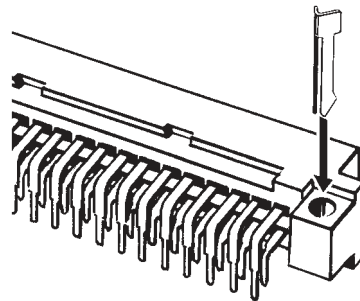

Fastening pins (XC5Z-0002) are used to keep the connector flush against the board during automated soldering.

Note: 1. For the XC5A, XC5F, XC5C, and XC5H.

2. Temporary fastening pins cannot be used with DIN-style connectors.

Dust Cover XC5T-962

(For DIN41612 C- or R-type Triple-row Plugs with 64 or 96 contacts)

XC5T-963

(For DIN41612 C- or R-type Triple-row Sockets with 64 or 96 contacts)

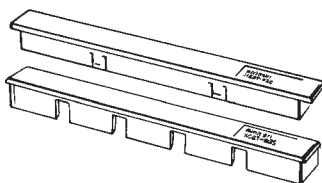

Model
XC5T-962
XC5T-963

Material: Polyamide resin (UL94 V-2)/natural

This is a dust-proof cover that is not used at the moment and not the one that protects against flux in automatic soldering.

Mating Diagrams

(unit: mm)

	Vertical (Standard)	Vertical (Reverse)	Stacking (See note.)	Horizontal (See note.)
Double-row Connectors				
Triple-row Connectors				

Note: By combining a Standard and a Reverse Connector, stacking and horizontal connections can be made. In this case, the triangular marks (terminal number 1) on the Plug and the Socket will not match.

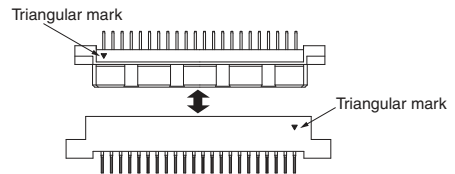

■ Precautions

Correct Use

Soldering

Automated Soldering

Use masking tape to mask Right-angle Connectors before automated soldering.

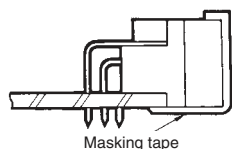

(Recommended tape: 3M Sumitomo #214)

Automated Soldering Conditions (Jet Flow)

1. Soldering temperature: $250 \pm 5^{\circ}\text{C}$
2. Continuous soldering time: Within 5 ± 1 s

Basic Mating Dimensions

Mating dimensions for all Connectors should be as shown in the following diagram.

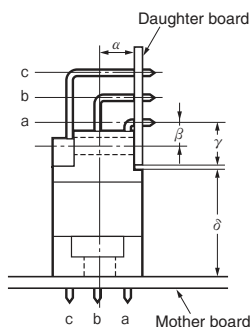

α : 3.55 mm

The distance between the center line of the mounting holes on the mother board and the daughter board. (This center line is shifted 0.3 mm toward row a from row b.)

β : 2.54 mm

The distance between the mounting holes on the daughter board and row a.

γ : 5.3 mm

The distance between the edge of the daughter board and row a.

δ : 12.4 to 14.2 mm

To ensure reliability, be sure to keep the Connectors within these dimensions when mounting.

The allowable margins for mating the Connectors are shown below.

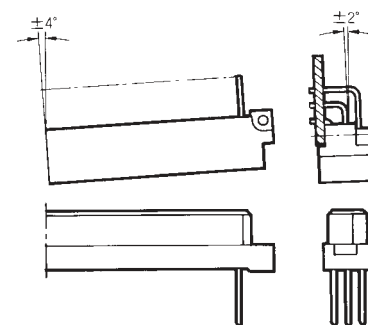
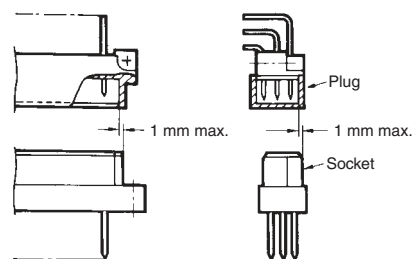

Please check each region's Terms & Conditions by region website.

OMRON Corporation

Electronic and Mechanical Components Company

Regional Contact

Americas

<https://www.components.omron.com/>

Asia-Pacific

<https://ecb.omron.com.sg/>

Korea

<https://www.omron-ecb.co.kr/>

Europe

<http://components.omron.eu/>

China

<https://www.ecb.omron.com.cn/>

Japan

<https://www.omron.co.jp/ecb/>

© OMRON Corporation 2012-2021 All Rights Reserved.
In the interest of product improvement, specifications are subject to change without notice.

Cat. No. G049-E1-04
1021 (0412)