

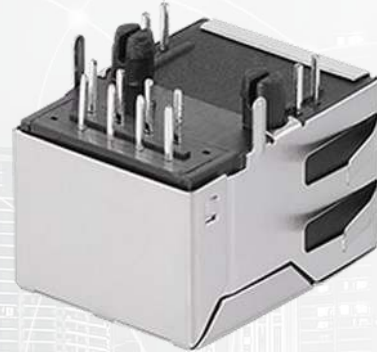

# TAOGLAS®



# Datasheet

## RJ45 ICM 10/100Base-T Short Body

**Part No:**  
TMJ16611AENL

**Description:**

RJ45 connector with integrated magnetics 10/100Base-T  
Single Port Tab-UP with right angle THT mount and LEDs

**Features:**

- EMI Finger
- Industrial grade
- Short Body
- RoHS & REACH Compliant

1.	Introduction	3
2.	Specifications	4
3.	Mechanical	5
4.	Electrical	6
5.	Packaging & Storage	7
<hr/>		
	Changelog	8

Taoglas makes no warranties based on the accuracy or completeness of the contents of this document and reserves the right to make changes to specifications and product descriptions at any time without notice. Taoglas reserves all rights to this document and the information contained herein. Reproduction, use or disclosure to third parties without express permission is strictly prohibited.



# 1. Introduction



Featuring a popular footprint and compatible package to industry RJ45 Integrated Connectors standards, the Taoglas TMJ16611AENL is an RJ45 Integrated Connector 10/100Base-T Single Port Tab Up with EMI Finger, its shielded short body design offers extra space, and with a schematic that enables AutoMDIX feature.

Typical Applications Include:

- Industrial Automation
- Hubs
- Routers
- Switches
- Wireless Access Points

Taoglas Magnetics offer an extensive product line of RJ45 Integrated Connectors designed for commercial and industrial grade applications, supporting 10/100 Base-T (Atmos100 Series) and 1G Base-T (Atmos1000 series). These surface mount or through-hole components provide reliable performance and maintain signal integrity that meets IEEE 802.3 standards, and they are UL certified. The Power over Ethernet options are also available including PoE, PoE+ and PoE++.

The majority of Taoglas RJ45 ICMs are manufactured with fully automated winding, assembly & testing to ensure consistent performance, quality and reliability while ensuring cost competitiveness for its customers. These products are fully compliant with the REACH and RoHS directive, and compatible with all major PHY vendors.

For customized products or support with integration, contact your regional Taoglas customer support team for further information.

## 2. Specifications

Electrical Performance @25°C	
Inductance OCL	350µH MIN @ 100KHz 0.1V 8mA DC Bias
Turns Ratio (±3%)	TX=1CT: 1CT      RX=1CT: 1CT
Insertion Loss	-1.0dB MAX @ 1-100Mhz
Return Loss	-18dB MIN @ 1-30Mhz
	-15dB MIN @ 30-60Mhz
	-12dB MIN @ 60-100Mhz
Cross talk	-40dB MIN @ 30Mhz
	-35dB MIN @ 60Mhz
	-30dB MIN @ 100Mhz
Common Mode Rejection	-30dB MIN @ 1-100Mhz
Hi-Pot	1500Vrms

Environmental Specifications	
Operating Temperature	-40°C TO +85°C

Material Specifications	
Housing	Thermoplastic PBT+30%G. F UL94V-0
Contact	Phosphor Bronze C5210R-EH Thickness = 0.35mm
Contact Plating	Gold Thickness = 6µ" min.
Pins	Brass C2680R-H Thickness = 0.35mm
Shield	Stainless Steel SUS 201-1-1/2H Thickness = 0.2mm

Compliance	
UL recognized - FILE NO. E528697	
RoHS Compliant	

Storage requirements	
Humidity	Storage Temperature
MSL - 1	-40°C TO +85°C

## 3. Mechanical

### 3.1 Mechanical Drawings

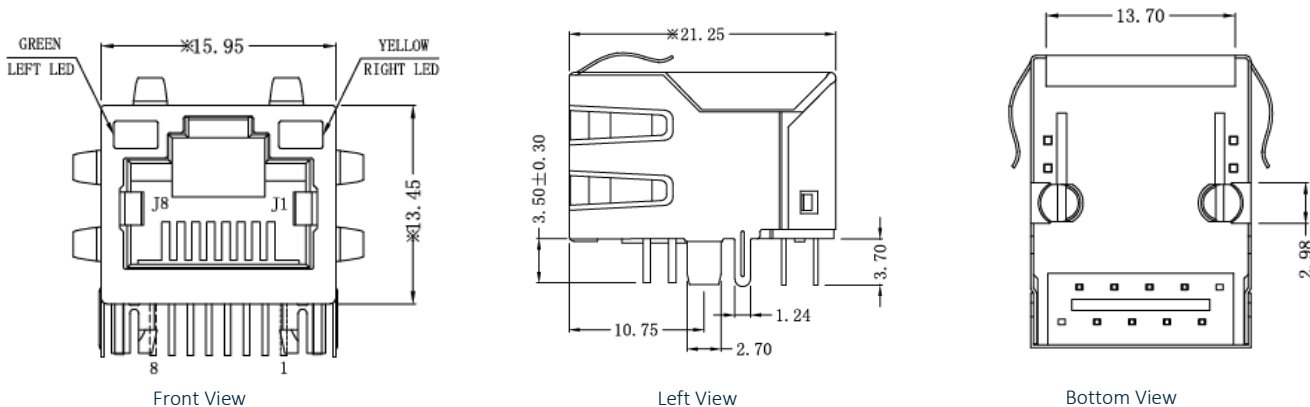

Mechanical Specifications	
Height Above Board	0.52" (13.3mm)
Width	0.627" (15.93mm)
Depth	0.837" (21.25mm)
Mounting Style	Through Hole (THT)
Mounting Angle	Right Angle

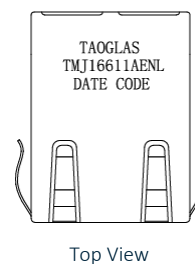

Dimensions are in millimeters with the following tolerances: X.XX =  $\pm 0.25$

### 3.2 PCB Layout

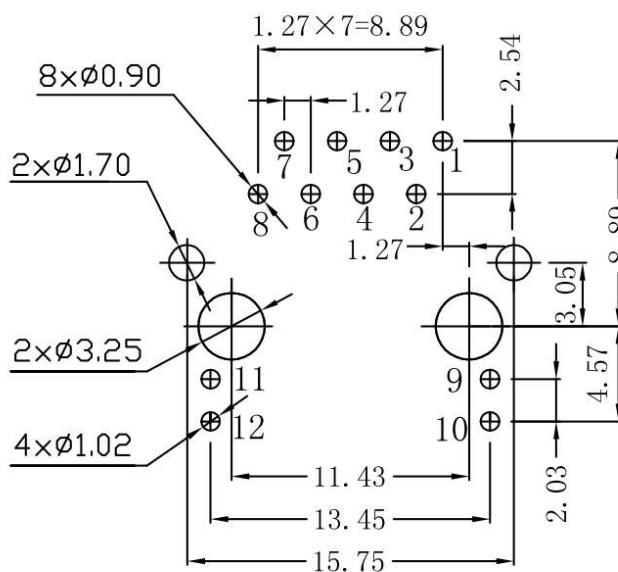

Suggested PCB Layout (Top View)

Dimensions are in millimeters with the following tolerances: X.XX =  $\pm 0.10$

## 4. Electrical

### 4.1 Electrical Drawings

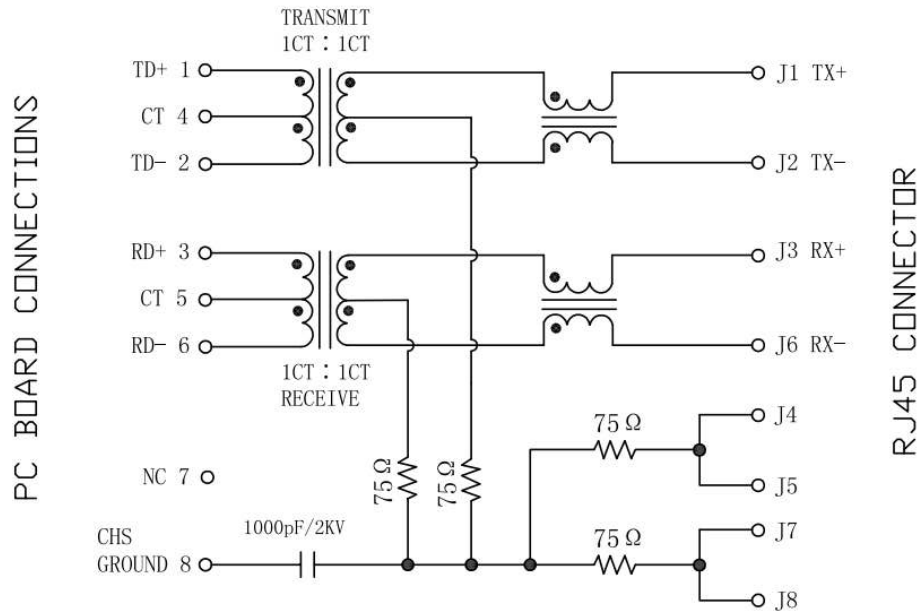

#### LED Electrical Specification

Standard LED	Wavelength (nm)	$V_F$ ( $I_F=20mA$ )	$I_R$ ( $V_R=5v$ )
Green	565	1.8~2.6v	10 $\mu A$ Max
Yellow	585	1.8~2.6v	10 $\mu A$ Max

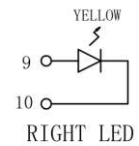
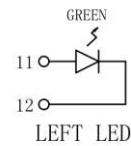

### 4.2 Profile of Wave Solder

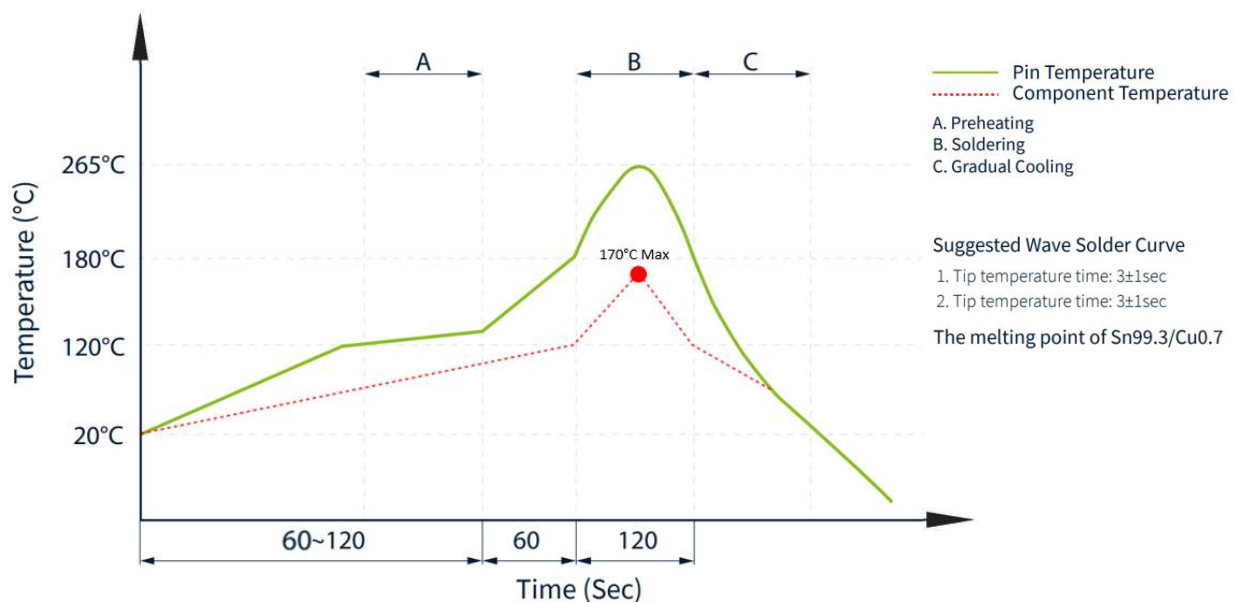

## 5. Packaging and Storage

### 5.1 SPQ

50 pcs/tray

Tray dimension: 299\*163\*23 mm

Tray Weight: 300g

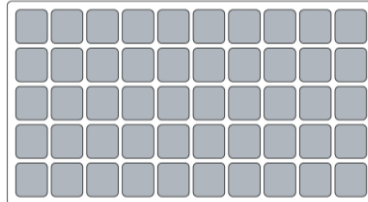

1 CTN = 24 trays = 1200 pcs

Carton dimensions: 320\*300\*301 mm

Carton Weight: 9kg

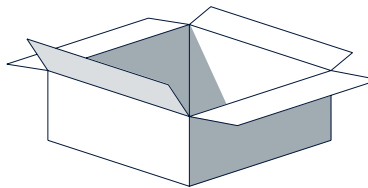

# Changelog

Changelog for the datasheet

**SPE-22-8-055 – TMJ16611AENL**

**Revision: A (Original First Release)**

Date:	2022-11-08
Notes:	
Author:	Javier Vasena

**Previous Revisions**





[www.taoglas.com](http://www.taoglas.com)

