



LEOPARD FAMILY



MADE IN U.S.A. RoHS COMPLIANT CE UL LISTED E669076

Optional White Faceplate

Optional Horizontal Top, Center & Bottom LED bar on Black or White faceplate

Optional Tri-Color for Center Only

Red or Optional Green LED bar on Left, Center or Right

FL-B101Q-HZ

Leopard Bargraph Meter AC Line Frequency 101 Segment in a 9/64 DIN CASE

High Accuracy Programmable AC Line Frequency Bargraph Meter and Transmitter.
Range 45-200Hz@80-300VAC, Optional 4-20mA or 0-10VDC Output.
Suitable for Power Generators and Switchboard Analog Meter Replacement.

Input Module Compatibility

LEOPARD FAMILY: More than 50 different Plug-in I-Series Input Signal Conditioners are approved for Leopard Family meters.



See www.texmate.com for an up to date listing.

LEOPARD

General Features

- AC Line Frequency Range 45-200Hz @ 80-300VAC
- A red or optional green, Tri-color 101 segment bargraph.
- Two 9 Amp Form C, and two 4 Amp Form A relays available
- Optional isolated 16 bit analog output. User or factory scalable to 4 to 20 mA, 0 to 20 mA or 0 to 10 V across any desired span from \pm one bar to the full scale range
- Provision to connect an external programming lockout switch.
- Optional NEMA-4 front cover.
- Four programmable setpoints.
- Relays activation can be selected to occur above (HI) or below (LO) each setpoint.
- Optional 6 inch adaptor to replace switch board analog meters.
- UL Listed

Specifications

Input Specs:.....Differential with Frequency to Voltage converter. Inputs resistively isolated to 1400V from the internal ground of meter by 1.94M Ω , so that phase to phase measurements up to 300V AC can be safely made

Full Scale Ranges:.....Factory installed range of 45Hz to 200Hz.

A/D Converter:.....14 bit single slope

Accuracy:..... \pm (0.05% of reading + 1 segment)

Temp. Coeff.:.....100 ppm/ $^{\circ}$ C (Typical)

Warm up time:.....2 minutes

Conversion Rate:.....10 conversions per second (Typical)

Bargraph Display:.....**101 segment 4" vertical (std)**, horizontal (optn), **red (std)**, green (optn),

Positive Overrange:...Bargraph display flashes

Negative Overrange: First segment of bargraph display flashes

Relay Output:.....Two 4 Amp Form A relays and Two 9 Amp Form C relays

Analog Output:.....Isolated 16 bit user scalable mA or V
 OIC (mA out).....4-20 mA @ 0 to 500 Ω max loop resistance
 OIV (volts out).....0-10 V DC @ 500 Ω or higher resistance

Power Supply:.....AC/DC Auto sensing wide range supply
PS1 (std).....**85-265 VAC, 50-400 Hz / 95-300 VDC @ 4.2W**
 PS2.....15-48 VAC,50-400 Hz / 10-72 VDC @ 4.2W

Operating Temp.:.....0 to 50 $^{\circ}$ C

Storage Temp.:.....-20 $^{\circ}$ C to 70 $^{\circ}$ C

Relative Humidity:.....95% (non condensing)

Case Dimensions:.....3/32 DIN, Bezel: 36x144 mm(1.42"x5.69")
 Depth behind bezel: (4.64") 117.5 mm
 Plus 10 mm (0.39") for Right-angled connector, or plus 18.3 mm (0.72") for Straight-thru connector, or plus 26.5 mm (1.05") for Push-On connector.

Weight:.....9.5 oz., 12 oz when packed

Index

Analog Output Scaling and Calibration..... 9	General Features..... 1	Overview of Display Modes, Scaling Capabilities and Operation Modes..... 3
Case Dimensions..... 12	Input Module Compatibility..... 1	Pin Descriptions..... 10
Component Layout..... 11	Input Module Component Glossary..... 11	Setpoint Adjust..... 7
Connector Pinouts..... 10	Installation..... 12	Setting the Colors..... 8
Connectors..... 10	One Point Quickset Rescaling and Calibration Procedure..... 6	Specifications..... 1
Controls and Indicators..... 2	Ordering Information..... 14	Standard Display Mode Calibration Procedure..... 6
Custom Face Plates and Scale..... 13	Opening the Case to Access Mode Select Headers... 4	Two Point Quickset Scaling and Calibration..... 5
Glossary of Programming Symbols and Modes of Operation..... 2		

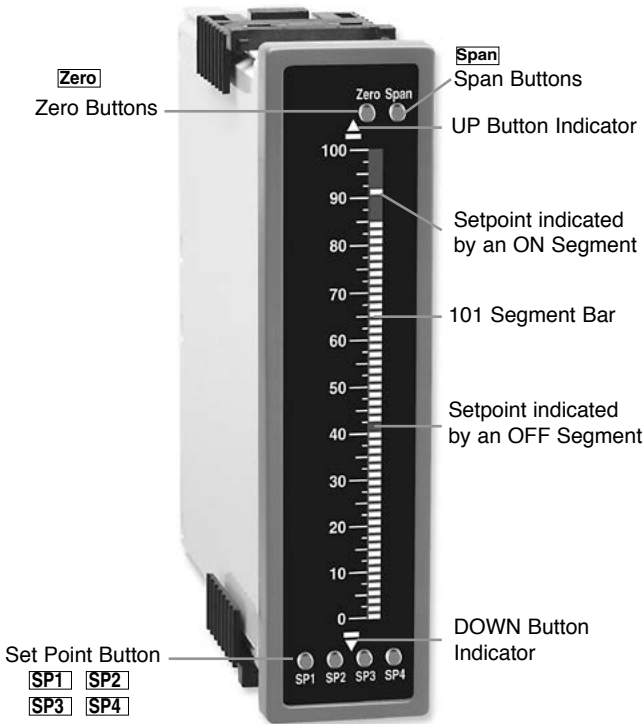

Front Panel Buttons

Zero Button

The Zero Button sets the Channel 1 low input signal scaling.

Span Button

The Span Button sets the Channel 1 high input signal scaling.

SP1, SP2, SP3 and SP4 Buttons

These buttons setup the corresponding setpoints.

Setpoint Indication

The position of setpoints on the bargraph display are indicated by an ON segment if the bargraph display is below the setpoint, and by an OFF segment if the bargraph display is above the setpoint. (See the drawing above)

Center Bar Display Option



This display option can be selected when a dual scale is required. A custom face plate is required for dual scales. Tri-Color option is available only for the Center Bar display.



Quickset Programming

This bargraph features Texmate's unique QUICKSET PROGRAMMING. When a front panel button is pressed the associated function is directly changed. The direction of change will be either up or down, as indicated by the UP and DOWN indicator LEDs. After the indicator LED lights up there is a 0.5 second delay before any change occurs. When a button is released and pressed again the direction of change is reversed. As there are no menu or sub-menus to navigate, the programming and setup is quick and

Glossary of Programming Symbols and Modes of Operation

To explain software programming procedures, logic diagrams are used to visually assist in following programming steps. The following symbols are used to represent the functions and displays of the meter:

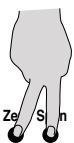
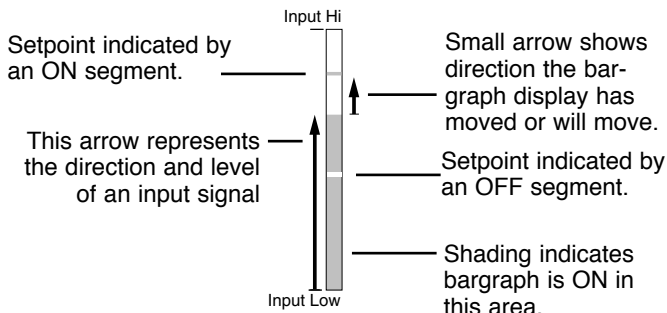

When two fingers are shown side by side, the two corresponding buttons must be pressed at the same time to initiate an indicated function.

Standard or Center Zero Display Mode Select Header



- Jumper clips enables standard display on CH1 and CH2.
- Jumper clip to enable Center Zero display.

Operating Mode Select Header

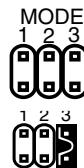

This header selects one of the two basic operating modes presently available for this meter.

- Mode 0 Bargraph with four set points displayed on bargraph display.
- Mode 3 Enables the Hysteresis mode for tank filling or tank emptying applications.

Relay Activation Mode Select Header

When no jumper clips are installed the relays will activate when the display exceeds the set point. Any relay that has a jumper clip installed will activate when the display is less than the set point.





Standard Display Mode

Standard Scaling

Standard display mode selected and scaled so bar increases as input signal increases from Low to Hi.

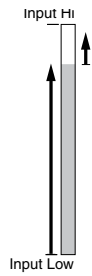

Inverse Scaling

Standard display mode selected and scaled so the bar increases as the input signal decreases from Hi to Low.

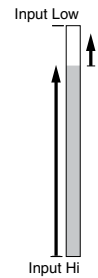

Mode 0 Channel Inputs

Display with 4 Set Points

With Standard display or Center point mode selected, the setpoints are indicated by an **ON** segment outside the bar display area and by an **OFF** segment inside the bar display area.



Horizontal and Reverse Mounting

with Custom Face Plate Installed

Horizontal or Reverse Mounting

Meters can be mounted horizontally in the panel and for those applications that require an opposite growth of the bar, the meter can be vertically or horizontally mounted upside down.

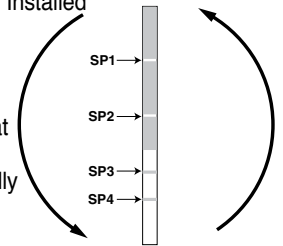

Mode 3 Hysteresis Band between SP1 & SP2

This mode enables the Hysteresis function. In order for Hysteresis to function, SP2 must be set to a value greater than SP1, and SP2 should be selected as High (h) Setpoint (See page 7). When these conditions are met, and Mode 3 is selected, then a Hysteresis band is created for the SP1 relay, with the upper limit of SP2 and the lower limit of SP1. SP2 relay continues to operate normally.

- For a tank filling application SP1 is set to a Low (L) Setpoint. SP1 relay can control a pump that fills the tank. With Mode 3 selected, SP1 relay activates for inputs less than the SP1 level. Once activated, SP1 relay will stay ON until the tank is filled to the SP2 level.

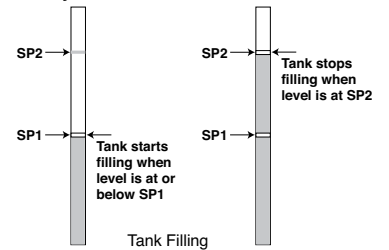

- For a tank emptying application SP1 is set to a High (h) Setpoint. SP1 can control a pump that empties the tank. With Mode 3 selected, SP1 relay activates for inputs greater than the SP2 level. Once activated, SP1 relay will stay ON until the tank is emptied to the SP1 level.

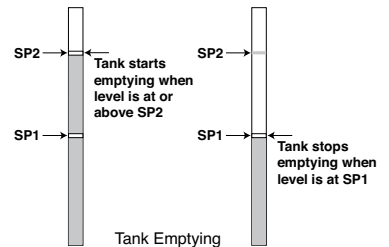

Opening the Case to Access Mode Select Headers

The mode select headers are located on the Display Driver Board assembly. To change any of the modes, it is best to remove the Display Driver Board assembly from the case. Before removing the Display Driver Board assembly from the front of the case it is necessary to remove the rear cover and slide the main board back an inch, or remove it, to disengage the pin and socket connector between the main board and the display assembly.

Step 1

Remove the front bezel by lightly levering the plastic catches up and forward in the a b c d sequence shown. Then remove the cover and scale faceplate.

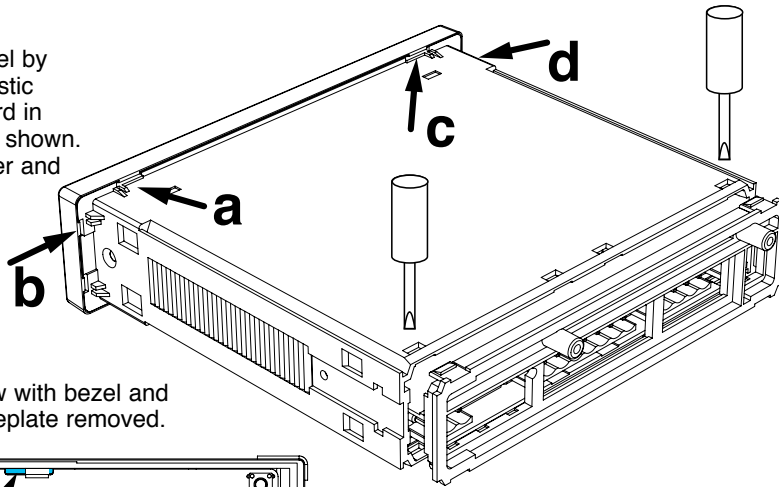

Front view with bezel and scale faceplate removed.

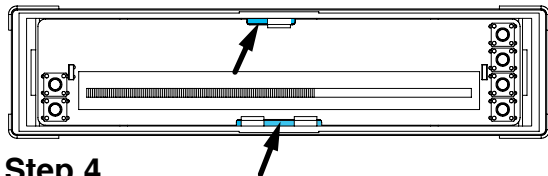

Step 4

Starting with the top first, insert a small flat bladed screw driver and carefully lever the plastic catch up and tilt the Display Board assembly forward. Then repeat this action with the bottom catches.

Step 2

Remove the rear cover plate by pressing down lightly with a small flat bladed screw driver to release two plastic catches, on either side of the case and levering backwards.

Step 3

Slide the Main Board back approximately 1" to disengage the pin and socket connection to the Display Driver Board.

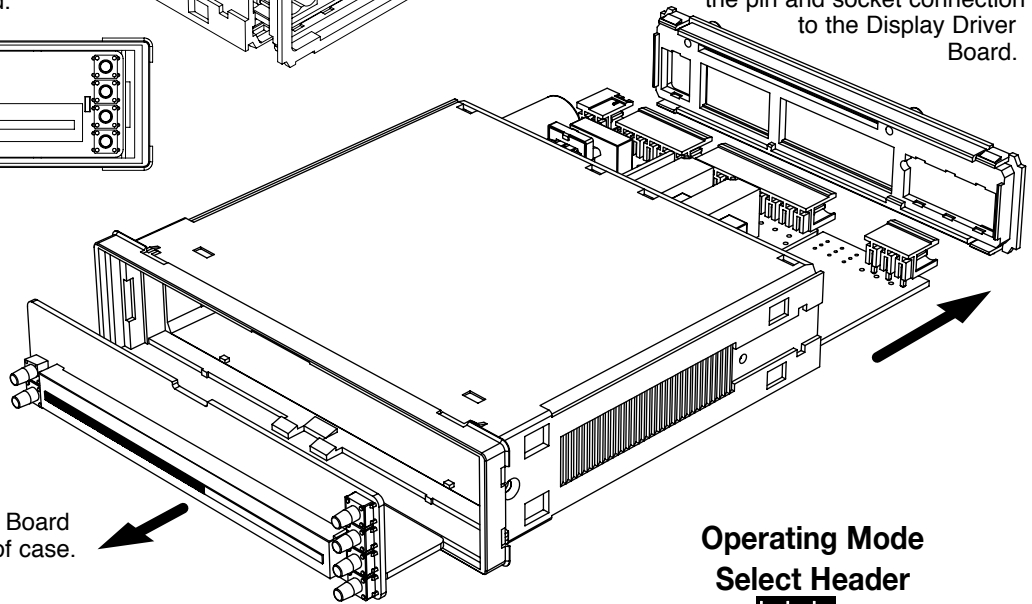

Step 5

Remove the entire Display Board assembly by sliding it out of case.

Operating Mode Select Header



Standard or Center Zero

Display Mode Select Header



Meter Exploded view

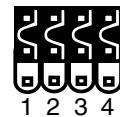
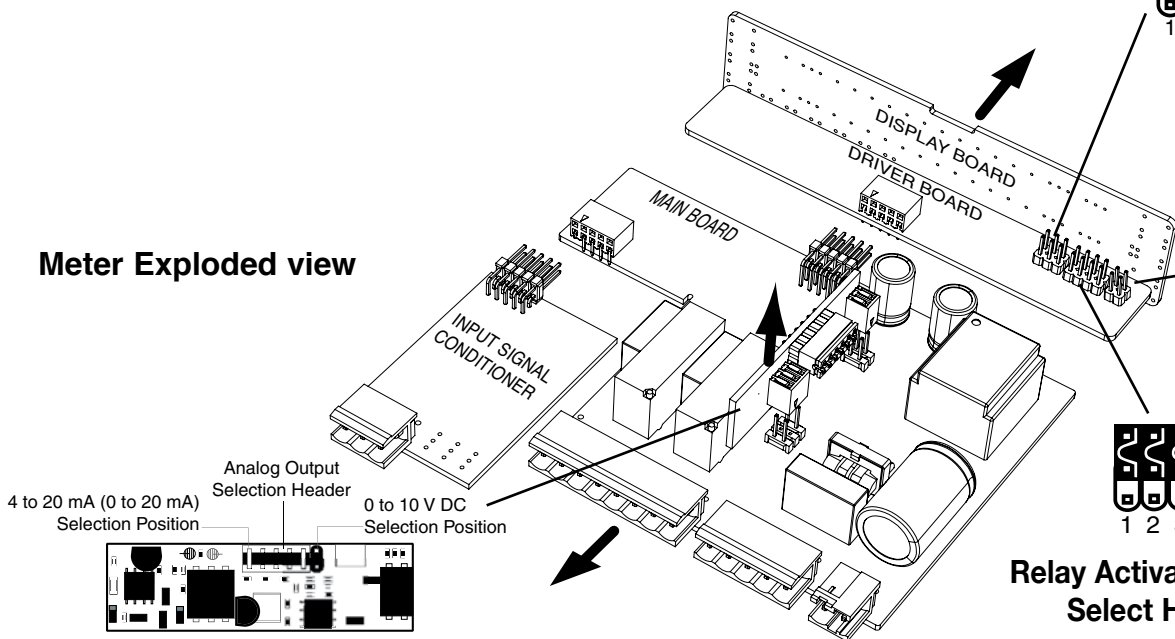

Relay Activation Mode Select Header

4 to 20 mA (0 to 20 mA) Selection Position
 Analog Output Selection Header
 0 to 10 V DC Selection Position

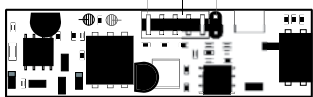

Optional 16 Bit Isolated Analog Output Module

Two Point Quickset Scaling and Calibration

Meters with **QUICKSET PROGRAMMING** feature a unique, easy-to-use, two point scaling and calibration system.

Scaling or calibration is accomplished simply, by applying a zero or low input signal and adjusting the bar to the desired reading, using the ZERO button. A higher input signal is then applied, and the bar is adjusted to the desired reading for that input value, using the SPAN button.

IMPORTANT DETAILS THAT MAKE QUICKSET PROGRAMMING EASY TO USE AND UNDERSTAND

1. The zero and span buttons are functionally the same, except as follows: The ZERO button can initiate a scaling with input signals from zero to 95% of fullscale. The Span button can initiate a scaling with input signals from 5% of fullscale to 105% of fullscale.
2. When a Zero or Span button is pressed, the Up or Down indicator LED will immediately light up to show the direction, in which the Bar will move, after a 0.5 second delay. If the button is released and pressed again, the opposite Up or Down indicator will light up, and 0.5 seconds later the Bar will begin to move in that direction until the button is released. When the bar is being adjusted to zero or fullscale, the bar will automatically stop at the zero or fullscale position, and will not overshoot these positions, even if the button continues to be pressed.
3. While the bar is being adjusted, a new offset and scale factor is continuously being calculated. At the moment the button is released, and the scaling is accepted, the calculation data is memorized and implemented. The Scaling calculation is based on the new position of the Bar, the input signal being applied at that moment, and the previously memorized position of the Bar and the input signal that was being applied, when the other button was last released.
4. Positive and negative signals maybe integrated into a two point scaling. However when either a ZERO or SPAN button is pressed the input signal being applied, must be more than 5% higher or lower than the previously memorized value of the input signal, that was being applied when the other button was last released. If not, the bar will flash, the scaling will not be accepted, and the previous scaling will still be retained in memory.
5. Because of the requirement, that a new scaling input signal must be 5% higher or lower than the previously stored value, it can sometimes be difficult to implement a desired scaling, particularly when using a calibrator that only has fixed output values. In this case Reset the Scaling by pressing the ZERO and SPAN buttons simultaneously for two seconds. Both scaling memories will be erased and an internal default scale factor will be loaded. This provides a display of zero to fullscale on the bar for an input of approximately 0 to 100% of the range selected on the input signal conditioning module. After Resetting the Scaling a new calibration, using either button, can be implemented with new input signal values. It is good practice to always use the Zero button for lower input signals and the Span button for higher input signals, even when the bar display scale is inverted.
6. The larger the difference between two points used for calibration, the better the accuracy. However if the difference is too high, and the output from the input signal conditioning module is greater than +2.1VDC, or less than -1.05VDC, the bar will flash over range. The calibration will not then be accepted and, the previous scaling will still be retained in memory. In this case, either a lower input signal must be used, or a higher range on the input module should be selected to recalibrate the meter.

Note: Most input signal conditioners have provisions for analog calibration and scaling. If the meter's scale factor is set to read zero with a zero input (shorted input), and to read 10 Bars fullscale with a 2.000 V input, any pre-calibrated signal conditioner with an output that does not exceed - 1 V to + 2 V, will read correctly in the meter without any further calibration.

Standard Display Mode Calibration Procedure



Standard Display with
Jumper Clips in OFF
position

Standard or Center Zero Display Mode may be selected, depending on the Operating Mode selected. If the standard display mode is not already selected open the meter case as showing on page 4 and move the jumper clips on the display mode select header to the OFF position.

STEP A REVIEW THE INPUT MODULE STATUS

- 1) Confirm that the correct range and input is selected on the input signal conditioning module.

Note: When undertaking an initial set up and primary scaling and calibration of the meter it is best to start with a reset of the scaling.

STEP B RESET THE SCALING

- 1) Apply power to the meter and press the ZERO and SPAN buttons simultaneously for 2 seconds. This erases any previously memorized scalings, and resets the scaling to the factory default, of approximately zero to full scale, for an input, that is 0 to 100% of the range selected on the input signal conditioner.

Note: To calibrate the bargraph you must be able to input two input signals. Usually the minimum input (LO Input) and the maximum input (HI Input) signals are used for optimum accuracy. However a scaling can be accomplished with any two signals that are higher or lower than each other by more than 5% of fullscale and are not greater than +2.1VDC or less than -1.05VDC.

STEP C SET THE LOW INPUT SIGNAL READING ON THE BAR

- 1) Apply the LO input signal (4ma in this example) to the input pins.
- 2) Using the ZERO button adjust the bar down to the required position.

STEP D SET THE HIGH INPUT SIGNAL READING ON THE BAR

- 1) Apply the high input signal (20mA in this example) to the input pins. Using the SPAN button adjust the bar to the required position. This position could be higher or lower than the position adjusted in Step 2. The scaling for an input of 4 to 20mA is now complete.

Reset the scaling
to the default value
on by pressing the
Zero and
Span buttons
simultaneously
for 2 secs.

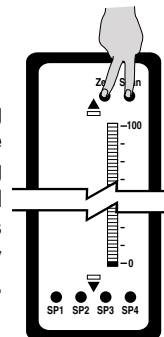

Apply 4 mA
to the
Input Pins
and adjust
bar display
to the required
position

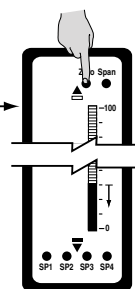

Apply 20 mA
to the
Input Pins
and adjust
bar display
to the required
position

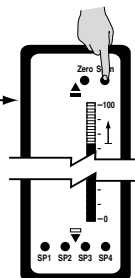

One Point Quickset Rescaling and Calibration Procedure

ONE POINT RECALIBRATION

As explained earlier, the FL-B101Q bargraph is calibrated using two point calibration. Once a bargraph is calibrated, the low end of the range may be then recalibrated without affecting the calibration of the high end, and vice versa.

For example, take an FL-B101Q that has been calibrated to read zero to full scale for an input of 4 to 20mA. If now the scaling has to be changed to read zero to full scale for an input of 0 to 20mA, only the low (4 mA) end needs to be recalibrated. The high (20 mA) end of the scaling is left untouched, and so does not change. The following one point recalibration procedure is used for this purpose.

STEP A RECALIBRATE THE LOW INPUT SIGNAL READING ON THE BAR

- 1) Apply the LO input signal (0ma in this example) to the input pins. The first segment will flash, indicating an under range condition.
- 2) Using the ZERO button adjust the bar up to the required position.
- 3) The FL-B101Q has now been recalibrated to read zero to fullscale for a 0 to 20 mA input.

Apply 0 mA
to the Input Pins
and adjust
bar display
to the required
position

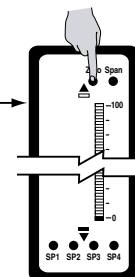

Setpoint Adjust

The bargraph has the option to have up to 4 setpoints (two 9A Form C relays and two 4A Form A relays) installed. Each relay may be set to activate either above or below its setpoint by inserting jumper clips on the Relay Activation header which is located on the Display Driver Board. See the layout diagram on Page 4 for the exact location. The steps to setup the setpoints are as follows:

1) SELECT THE RELAY ACTIVATION MODE FOR EACH INSTALLED RELAY

Make sure that the required relays have been installed in the meter. Refer to the component layout on Page 11 for relay positions. If a jumper clip is installed in a specific relay position on the Relay Activation Mode Header, that relay will activate when the display bar is lower than the programmed setpoint. If no jumper clip is installed in a specific relay position on the Relay Activation Mode Header, that relay will activate when the display bar is equal to or higher than the programmed setpoint. The Diagrams below show some of the various possibilities for relay activation.

Default

SP1, SP2, SP3, and SP4 all activate when input is equal to or higher than set point.

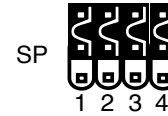

SP2 and SP4 activate when input is lower than set point. SP1 and SP3 activate when input is equal to or higher than set point.

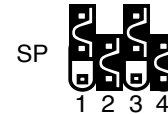

SP2 activate when input is lower than set point. SP1, SP3 and SP4 activate when input is equal to or higher than set point.

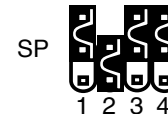

SP1 and SP3 activate when input is lower than set point. SP2 and SP4 activate when input is equal to or higher than set point.

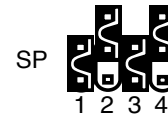

SP1, SP2, SP3, and SP4 all activate when input is lower than set point.

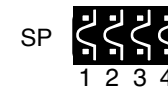

SP1 and SP2 activate when input is lower than set point. SP3 and SP4 activate when input is equal to or higher than set point.

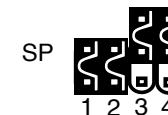

2) ADJUST THE SETPOINT FOR EACH RELAY

The setpoint for each relay is set by the front panel buttons marked SP1, SP2, SP3 and SP4. When a front panel button is pressed and held down, the associated setpoint is directly changed. The direction of change will be either up or down, as indicated by the UP and DOWN indicator LEDs. After the indicator LED lights up there is a 0.5 second delay before any change occurs. To reverse the direction of change, release the button and then press down again. As there are no menus or sub-menus to navigate, the programming and setup is quick and easy.

Setpoints are indicated on the bar display by an ON segment if the bar is below the setpoint and with an OFF segment if the bar display is above the setpoint.

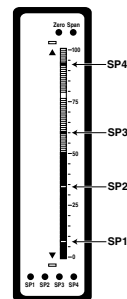

Setting the Colors (For CHT or CVT Center Bar display options only)

To comply with the latest safety requirements, the tri-color bargraph is designed like a traffic light, to display either red, orange or green, but only one color at a time. When the bar reaches a selected color change point, the entire bar will change to the color designated for that zone. This eliminates any ambiguity as to the signal status, especially just after transitioning to a new zone.

However, if two or more setpoints with differently specified colors are positioned at the same set point value, the color specified for the set point with the highest identifying number will be displayed. When set points are set to the same value, the SP4 color overrides the SP3 color, the SP3 color overrides the SP2 color, and the SP2 color overrides the SP1 color.

STEP A ENTER COLOR SET MODE

Hold down ALL four setpoint buttons (SP1, SP2, SP3 and SP4) and apply power to the meter. The meter will light up in the Color Set Mode. Release all the setpoint buttons.

STEP B SELECT COLOR FOR BAR ABOVE SETPOINT 1

Hold down the SP1 button. The color of the bar segments below SP1 will cycle between red, green and orange. Release the SP1 button when the bar is the required color. Now Whenever the bar is above the SP1 level it will be this color. When the bar is below the SP1 level it will always be red.

STEP C SELECT COLOR FOR BAR ABOVE SETPOINT 2

Hold down the SP2 button. The color of the bar segments below SP2 will cycle between red, green and orange. Release the SP2 button when the bar is the required color. Now whenever the bar is above the SP2 level it will be this color.

STEP D SELECT COLOR FOR BAR ABOVE SETPOINT 3

Hold down the SP3 button. The color of the bar segments below SP3 will cycle between red, green and orange. Release the SP3 button when the bar is the required color. Now whenever the bar is above the SP3 level it will be this color.

STEP E SELECT COLOR FOR BAR ABOVE SETPOINT 4

Hold down the SP4 button. The color of the bar segments below SP4 will cycle between red, green and orange. Release the SP4 button when the bar is the required color. Now whenever the bar is above the SP4 level it will be this color.

STEP F EXIT COLOR SET MODE

Turn off the power to the meter for 5 seconds and then re apply the power. The bargraph will now work with the programmed colors.

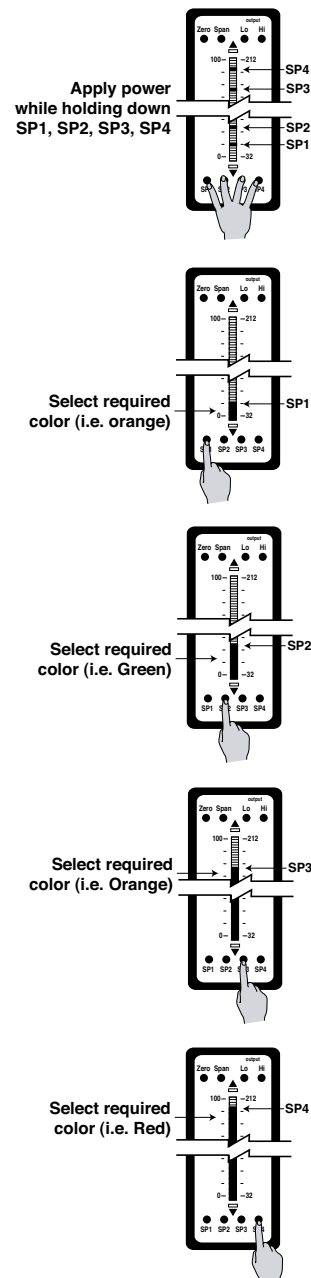

Analog Output Scaling and Calibration

When the optional analog output module is installed, an independently calibrated 16 bit isolated, voltage or current analog output is available. **The analog signal is independently scaled to the input signal and not to the bargraph display.** It is important to note that the Analog Output is completely independently of the bargraph display. This means for example that the bargraph display may be scaled to go from zero to full scale as the input changes from 0 to 5V, while at the same time, the analog output is scaled to go from 4 to 20mA as the input changes from 2 to 3V. Rescaling the bargraph or the analog output will not affect the scaling of the other.

To calibrate the Analog Output you must be able to input two input signals. Usually the minimum input (LO Input) and the maximum (HI Input) signals are used for maximum accuracy.

For example the five steps to obtain an Analog Output of 4mA to 20mA for an input of 0 to 10V are:

STEP A ACCESS THE ANALOG CALIBRATION MODE

- 1) Confirm the internal analog output module is installed and that the required voltage or current output option is selected.
- 2) Turn OFF the power to the bargraph.
- 3) Hold down the ZERO and SPAN buttons simultaneously and re-power the bargraph. The ZERO button will now function as the LO button and the SPAN button will now function as the HI button for calibrating the Analog Output.

STEP B RESET THE ANALOG OUTPUT SCALING

- 1) Press the LO and HI buttons simultaneously and hold them down for 2 seconds. This will reset the analog output scaling to the default value. The default analog output scaling is approximately 0 to 20mA (0 to 10V if voltage output option is selected) for an input that is 0 to 100% of the range selected on the input signal conditioner.

STEP C CALIBRATE ANALOG OUTPUT FOR LO SIGNAL

- 1) Apply the low input signal (0V in this example) to the meter.
- 2) Connect an external multimeter to the analog output pins (Pins 17 and 18).
- 3) Using the LO button adjust the analog output as measured on the external multimeter to be the required value. (4mA in this example). When the LO button is pressed, the UP or DOWN indicator LED shows the direction of change. To reverse the direction of change release the LO button and press down again. Initially the output changes very slowly, but speeds up as the LO button remains pressed down. The analog output for a low input can be set in this step to any value in the range of 0 to 20mA or 0 to 10V (if the voltage output option is selected).

STEP D CALIBRATE ANALOG OUTPUT FOR HI SIGNAL

- 1) Next apply the high input signal (10V in this example) to the meter.
- 2) Using the HI button, adjust the analog output as measured on the external multimeter to be the required value. (20mA in this example). When the HI button is pressed the UP or DOWN indicator LED shows the direction of change. Release the HI button and press again to reverse the direction of change. Initially the output changes very slowly, but speeds up as the HI button continues to remain pressed. This output may be higher or lower than the value set in Step C, and may be any value in the range of 0 to 20mA or 0 to 10V. This allows the easy reversal of analog output that is required in some applications.

STEP E EXIT THE ANALOG OUTPUT CALIBRATION MODE

- 1) Turn OFF the power to the bargraph
- 2) Re-power the bargraph. The two buttons will now return to their original function of ZERO and SPAN.
- 3) Calibration is now complete and the bar is scaled for a 0 to 10V input to produce an analog output of 4 to 20mA.

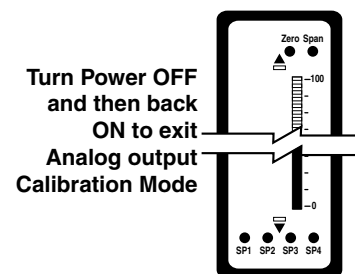
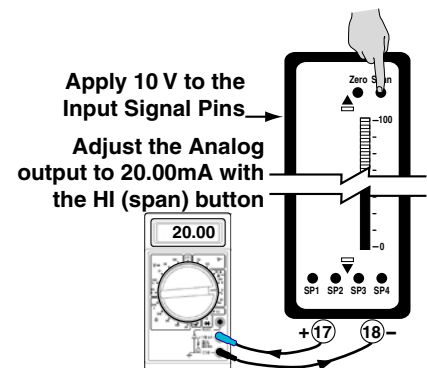
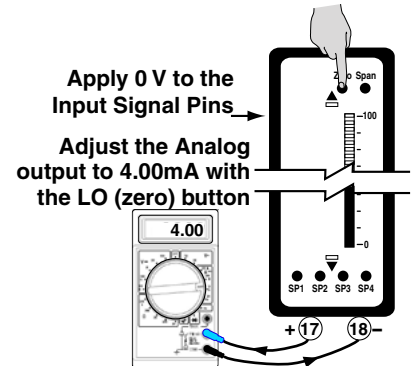
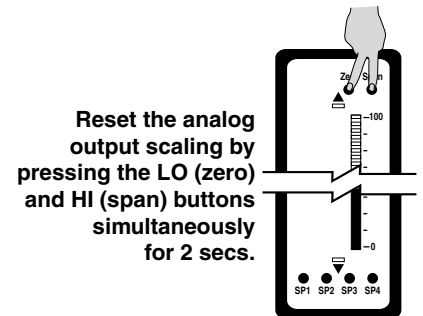
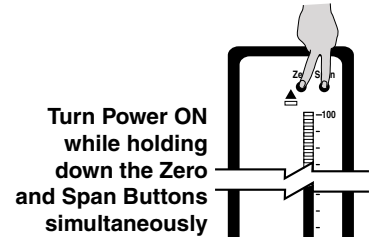

Connector Pinouts

This meter uses plug-in type screw terminal connectors for all input and output connections. The power supply connections (pins 23 and 24) have a unique plug and socket outline to prevent cross connection. The main board uses standard right-angled connectors.

Replacement 2-, 3-, and 4-pin plug connectors are available.

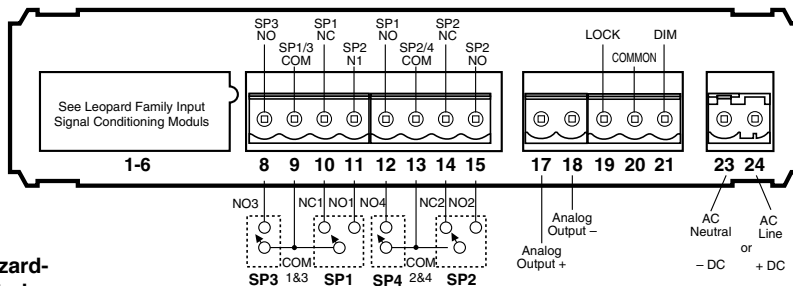

WARNING

AC and DC power supply voltages are hazardous. Make sure the power supply is isolated before connecting to the meter.

Note: The sequence of setpoint outputs is 3-1-4-2, enabling delay on make (dom) and delay on break (dob) to be used with both Form "C" relays.

Pin Descriptions

Input Signal – Pins 1 to 6

Pins 1 to 6 are reserved for the input signal conditioner. See the data sheet for the selected input signal conditioner.

Pins 8 to 15 – Relay Output Pins

- Pin 8** SP3 NO. Normally Open 4 Amp Form A.
- Pin 9** SP1/3 COM. Common for SP1 and SP3.
- Pin 10** SP1 NC. Normally Closed 9 Amp Form C.
- Pin 11** SP1 NO. Normally Open 9 Amp Form C.
- Pin 12** SP4 NO. Normally Open 4 Amp Form A.
- Pin 13** SP2/4 COM. Common for SP3 and SP4.
- Pin 14** SP2 NC. Normally Closed 9 Amp Form C.
- Pin 15** SP2 NO. Normally Open 9 Amp Form C.

Pins 17 to 21 – Rear Panel Switches

- Pin 17** **ANALOG OUTPUT (+).** mA (0 to 20 mA/4 to 20 mA) or V (0 to 10 V) output is header selectable.
- Pin 18** **ANALOG OUTPUT (-).** mA (0 to 20 mA/4 to 20 mA) or V (0 to 10 V) output is header selectable.
- Pin 19** **Programming LOCK.** By connecting the LOCK pin to the COMMON pin, the meter's programmed parameters can be viewed but not changed.
- Pin 20** **COMMON.** To activate the LOCK or DIM functions from the rear of the meter, the respective pins have to be connected to the COMMON pin. This pin is connected to the internal power supply ground.
- Pin 21** **DIM.** By connecting the display dim (DIM) pin to the COMMON pin, the display brightness setting is halved.

Pins 23 and 24 – AC/DC Power Input

Auto-sensing AC/DC power supply. For voltages between 85-265 V AC / 95-300 V DC (PS1) or 15-48 V AC / 10-72 V DC (PS2).

- Pin 23** **AC Neutral / -DC.** Neutral power supply line.
- Pin 24** **AC line / +DC.** Live power supply line.

Connectors



WARNING

AC and DC input signals and power supply voltages can be hazardous. Do Not connect live wires to terminal blocks, and do not insert, remove or handle terminal blocks with live wires connected.

Standard plug-in screw terminal blocks provided by the Manufacturer

Input Power Screw Terminal Plug

Part Number:
93-PLUG2P-DP

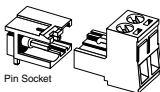

Right-angled Screw Terminal Plug

Part Numbers:
93-PLUG2P-DR...2 pins
93-PLUG3P-DR...3 pins
93-PLUG4P-DR...4 pins
93-PLUG5P-DR...5 pins
93-PLUG6P-DR...6 pins

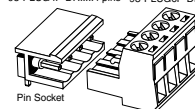

Straight-thru Input Power Screw Terminal Plug

Part Number:
93-PLUG2P-SP

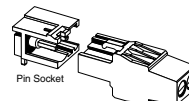

Straight-thru Screw Terminal Plug

Part Numbers:
93-PLUG2P-DS...2 pins
93-PLUG3P-DS...3 pins
93-PLUG4P-DS...4 pins

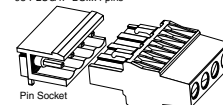

Component Layout

MAIN BOARD

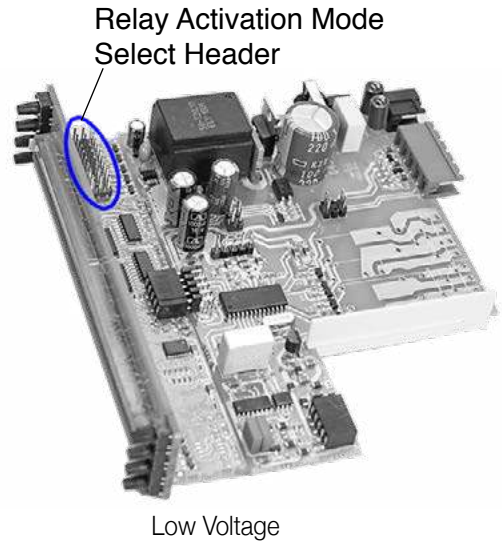
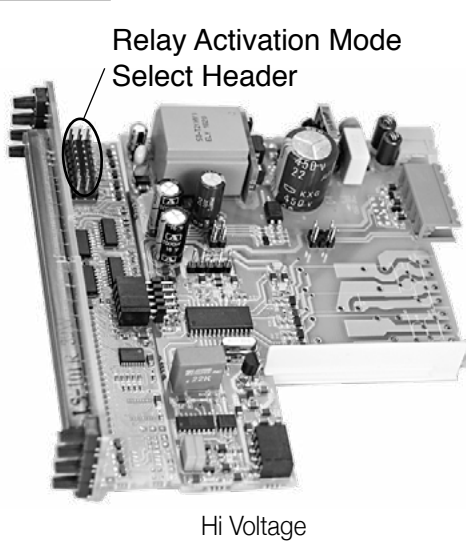

INPUT MODULE

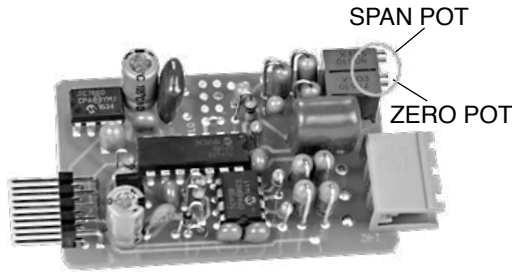

IF02 Line Frequency, 50-500VAC, 199.9Hz

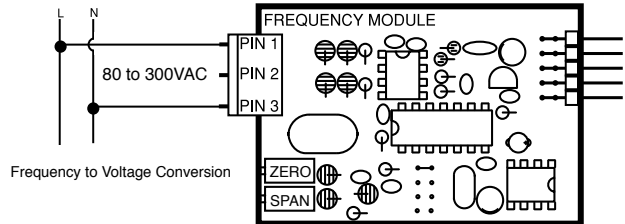

Input Module Component Glossary

SPAN

SPAN Potentiometer (Pot)

To the Right Rear

Turn Clockwise to Increase Reading

If provided, the 15 turn SPAN pot is always on the right side (as viewed from the rear of the meter). Typical adjustment is 20% of the input signal range.

ZERO

ZERO Potentiometer (Pot)

To the Left Rear

Turn Clockwise to Increase Reading

If provided, the ZERO pot is always to the left of the SPAN pot (as viewed from the rear of the meter). Typically it enables the input signal to be offset $\pm 5\%$ of full scale (-100 to +100 counts).

\oplus - 100 Counts 0 \oplus + 100 Counts

15 Turn Potentiometer

Installation

1. Install and wire meter per local applicable codes/regulations, the particular application, and good installation practices.

2. Install meter in a location that does not exceed the maximum operating temperature and that provides good air circulation.

3. Separate input/output leads from power lines to protect the meter from external noise. Input/output leads should be routed as far away as possible from contactors, control relays, transformers and other noisy components. Shielding cables for input/output leads is recommended with shield connection to earth ground near the meter preferred.

4. A circuit breaker or disconnect switch is required to disconnect power to the meter. The breaker/switch should be in close proximity to the meter and marked as the disconnecting device for the meter or meter circuit. The circuit breaker or wall switch must be rated for the applied voltage (e.g., 120VAC or 240VAC) and current appropriate for the electrical application (e.g., 15A or 20A).

5. See *Case Dimensions* section for panel cutout information.

6. See *Connector Pinouts* section for wiring.



7. Use 28-12 AWG wiring, minimum 90°C (HH) temperature rating. Strip wire approximately 0.3 in. (7-8 mm).

8. Recommended torque on all terminal plug screws is 4.5 lb-in (0.51 N-m).

Case Dimensions

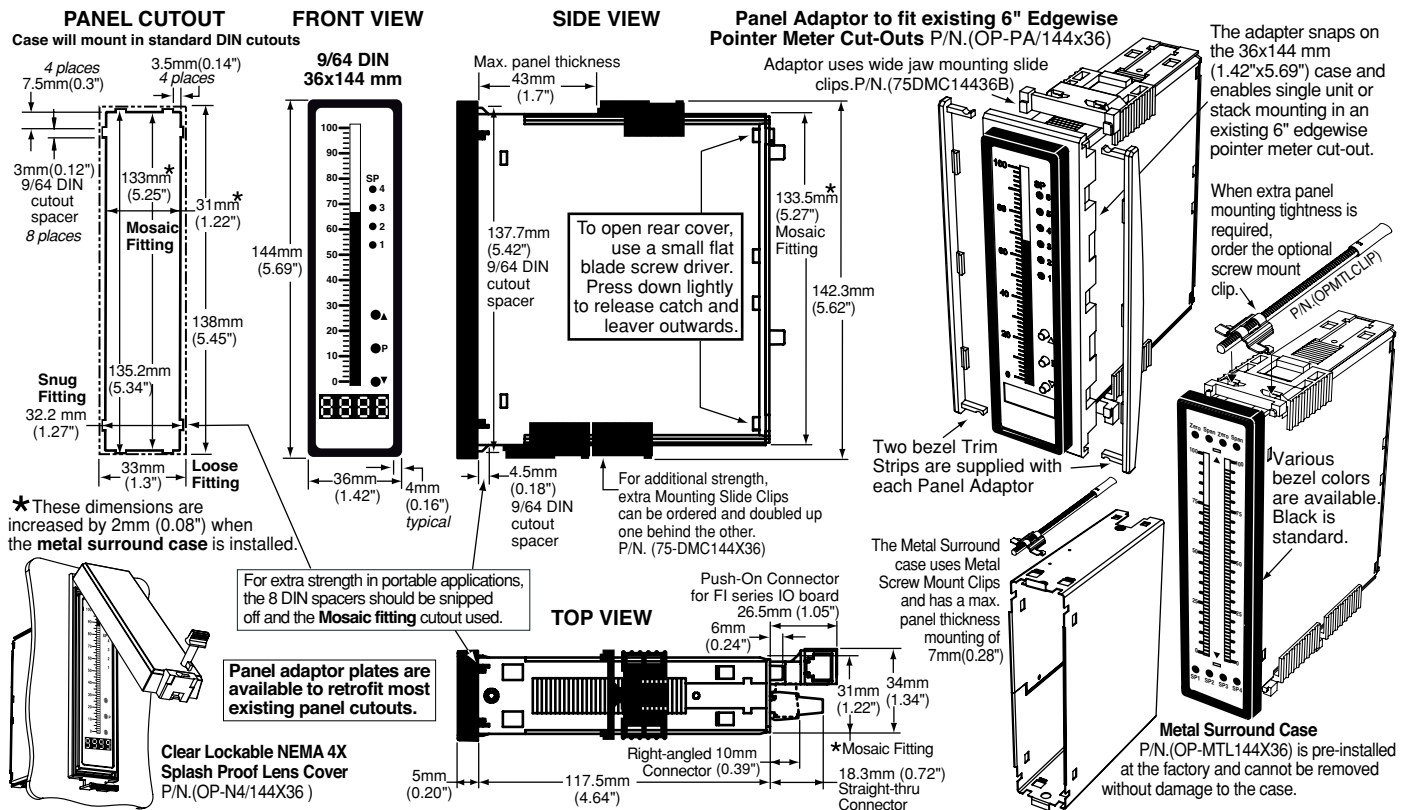

Custom Face Plates and Scales

Texmate Produces Thousands of Custom OEM Face Plates

Have Texmate Design and Build a Custom Face Plate to Suit your Next project!

- Custom face plates have a non-recurring artwork charge. A serial number is then assigned to each artwork, to facilitate re-ordering. We prefer custom logos and special artwork to be supplied in an Illustrator or Photoshop file format.
- Small Run or One-Off custom face plates incur an installation charge, and are generally printed on a special plastic film, which is then laminated to custom faceplate blanks as required.
- Large Run (300 pieces min): custom face plates are production silk screened, issued a part number, and held in stock for free installation as required by customer orders.
- OEMs may also order Custom Meter Labels, Box Labels Custom Data Sheets and Instruction Manuals.

Part Number *Description* *List*

Small Run Custom Face plates for Bargraphs

- ART-NRC-DES . . . Small run NRC custom faceplate design.
 - ART-NRC-LOGO. . . Small run NRC custom faceplate design with Co.Logo . .
 - ART-FS1 Small run custom Faceplate - 1 color
 - ART-FS2 Small run custom Faceplate - 2 color
 - ART-FS3 Small run custom Faceplate - 3 color
 - ART-FS4 Small run custom Faceplate - 4 color
 - ART-FS5 Small run custom Faceplate - 5 color
- Specify artwork serial number when ordering face plate installation.
ie: AFB-XXXXX

Large Run Custom Face plates for Bargraphs

- ART-NRC-FILM. . . Large run NRC custom faceplate design & films.
- ART-FPMAINT . . . Inventory management fee for 2 years
- ART-FL1 Large run 300pcs custom faceplate - 1 color
- ART-FL2 Large run 300pcs custom faceplate - 2 color
- ART-FL3 Large run 300pcs custom faceplate - 3 color
- ART-FL4 Large run 300pcs custom faceplate - 4 color
- ART-FL5 Large run 300pcs custom faceplate - 5 color

When ordering Large Run Face plates to be installed specify the custom part number issued for each different artwork. ie: 77-FLXXXXX

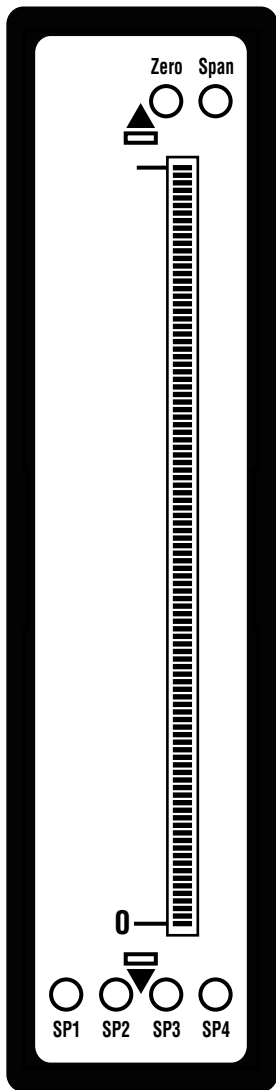

28 mm (1.1")

• Face plate scales and numbers shown at close to full scale

• Some horizontal scales only have numbers on each second major divisions.

	1	1.2	1.5	2	2.5	3	4	4.5	5	6	7.5	8	9
	10	12	15	20	25	30	40	45	50	60	75	80	90
	100	120	150	200	250	300	400	450	500	600	750	800	900
	1000	1200	1500	2000	2500	3000	4000	4500	5000	6000	7500	8000	9000
10	12	15	20	25	30	40	45	50	60	75	80	90	
9						35	40	45		70		70	80
8	10			20	25				50				
7		12		15		30	35			60		60	70
6					20	25			40	50		50	60
5	6		10		15	20			30		40	40	50
4		6		10		15			20	30	30	30	40
3	4				10	15			15	20	20	20	30
2		3		5		10			10	10	20	20	20
1						5			5	10	10	10	10
0	0	0	0	0	0	0	0	0	0	0	0	0	0
	10x5	6x2x2	5x3x2	4x5x2	5x5x2	6x5	8x5	9x5	10x5	6x5	7.5x5	8x5	9x5
	Div. 50	24	30	40	50	30	40	45	50	30	37.5	40	45

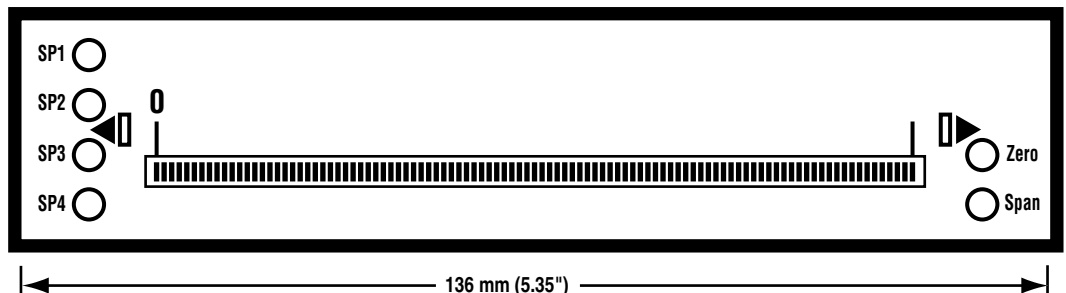

136 mm (5.35")

Ordering Information



Add to the basic model number the order code suffix for each standard option required. The last suffix is to indicate how many different special options and or accessories that you may require to be included with this product.

Ordering Example: FL-B101Q-HZ-RVR-PS1-IF02-OIC-R11-OA2. OA2 are ZR and an OP-N4/144X36 (Two "Options and Accessories")

► BASIC MODEL NUMBER

FL-B101Q-HZ . 144x36mm, AC Line Frequency 101 Seg. Bargraph

Standard Options for this Model Number

Order Code Suffix	Description	List
-------------------	-------------	------

► DISPLAY

BHG	Green LED Bargraph, Horizontal, Bottom position	
BHR	Red LED Bargraph, Horizontal, Bottom position	
CHG	Green LED Bargraph, Horizontal, Center position	
CHR	Red LED Bargraph, Horizontal, Center position	
CHT	Center Horizontal - Tri-Color	
CVG	Green LED Bargraph, Vertical, Center position	
CVR	Red LED Bargraph, Vertical, Center position	
CVT	Center Vertical - Tri-Color	
LVG	Green LED Bargraph, Vertical, Left side	
LVR	Red LED Bargraph, Vertical, Left side	
RVG	Green LED Bargraph, Vertical, Right side	
RVR	Red LED Bargraph, Vertical, Right side	
THG	Green LED Bargraph, Horizontal, Top position	
THR	Red LED Bargraph, Horizontal, Top position	

► POWER SUPPLY

PS1	85-265VAC/95-300VDC	
PS2	15-48VAC/10-72VDC	

► INPUT MODULES

Unless otherwise specified Texmate will ship all modules precalibrated with factory preselected ranges and/or scalings as shown in **BOLD** type.

IF02	Line Frequency, 45-200Hz @ 80-300VAC	
------	--------------------------------------	--

► ANALOG OUTPUT

OIC	Isolated 16 Bit Current Output, 4-20mA	
OIV	Isolated 16 Bit Voltage Output, 0-10VDC	

► RELAY OUTPUT

R1	Single 4A Form A Relay	
R2	Dual 4A Form A Relays	
R11	Single 9A Form C Relay	
R12	Dual 9A Form C Relays	
R13	Dual 9A Form C & One 4A Form A Relays	
R14	Dual 9A Form C & Dual 4A Form A Relays	
R15	Single 9A Form C & Dual 4A Form A Relays	
R16	Single 9A Form C & Single 4A Form A Relays	

Special Options and Accessories

Part Number	Description	List
-------------	-------------	------

► SPECIAL OPTIONS (Specify Inputs or Outputs & Req. Reading)

ZR	Range change from the standard input as shown in BOLD type	
ZS-AOB	Custom scaling of analog output for Q-series bargraphs	

► ACCESSORIES

75-DBZ144X36	Black bezel for 144x36mm Case	
75-DMC144X36	Side Slide Brackets-Wide opening (2 pc)	
75-DMC144X36	Side Slide Brackets-stand. (2 pc) - extra set	
93-PLUG2P-DP	Extra Screw Terminal Conn., 2 Pin Power Plug	
93-PLUG2P-DR	Extra Screw Terminal Conn., 2 Pin Plug	
93-PLUG3P-DR	Extra Screw Terminal Conn., 3 Pin Plug	
93-PLUG4P-DR	Extra Screw Terminal Conn., 4 Pin Plug	
93-PLUG5P-DR	Extra Screw Terminal Conn., 5 Pin Plug	
DN.CAS144X36	Complete 144x36mm Case with bezel	
OP-MTL144X36	Metal Surround Case, includes screw mounting clips	
OP-MTLCLIP	Screw Mounting Clips (2 pc) - to screw tighten slide brackets	
OP-N4/144X36	144x36mm clear lockable front cover-NEMA 4X, splash proof	
OP-PA/144X36	Panel Adapter for 144x36mm from 6 inch cutout	

For Custom Face Plates and Scales see page 13.

Prices subject to change without notice.

WARRANTY

Texmate warrants that its products are free from defects in material and workmanship under normal use and service for a period of one year from date of shipment. Texmate's obligations under this warranty are limited to replacement or repair, at its option, at its factory, of any of the products which shall, within the applicable period after shipment, be returned to Texmate's facility, transportation charges pre-paid, and which are, after examination, disclosed to the satisfaction of Texmate to be thus defective. The warranty shall not apply to any equipment which shall have been repaired or altered, except by Texmate, or which shall have been subjected to misuse, negligence, or accident. In no case shall Texmate's liability exceed the original purchase price. The aforementioned provisions do not extend the original warranty period of any product which has been either repaired or replaced by Texmate.

USER'S RESPONSIBILITY

We are pleased to offer suggestions on the use of our various products either by way of printed matter or through direct contact with our sales/application engineering staff. However, since we have no control over the use of our products once they are shipped, **NO WARRANTY WHETHER OF MERCHANTABILITY, FITNESS FOR PURPOSE, OR OTHERWISE** is made beyond the repair, replacement, or refund of purchase price at the sole discretion of Texmate. Users shall determine the suitability of the product for the intended application before using, and the users assume all risk and liability whatsoever in connection therewith, regardless of any of our suggestions or statements as to application or construction. In no event shall Texmate's liability, in law or otherwise, be in excess of the purchase price of the product.

Texmate cannot assume responsibility for any circuitry described. No circuit patent or software licenses are implied. Texmate reserves the right to change circuitry, operating software, specifications, and prices without notice at any time.



1934 Kellogg Ave., Carlsbad, CA 92008
 Tel: 1-760-598-9899 • USA 1-800-839-6283 • 1-800-TEXMATE
 Fax: 1-760-598-9828 • Email: orders@texmate.com • Web: www.texmate.com

FL-B01Q-HZ Technical Manual Copyright © 2018 Texmate Inc. All rights reserved. Published by: Texmate Inc. USA. Information in this Technical Manual is subject to change without notice due to correction or enhancement. The information described in this manual is proprietary to Texmate, Inc. and may not be copied, reproduced or transmitted, in whole or in part, in connection with the design, manufacture, or sale of apparatus, device or private label product without the express written consent of Texmate, Inc.