

MAXIM**+5V-Output, Step-Up, Current-Mode PWM
DC-DC Converter****MAX751****General Description**

The MAX751 is a +5V-output, CMOS, step-up, switch-mode DC-DC converter. Minimum input start-up voltage is 1.2V. From a 2.7V supply, the output current capability is guaranteed to be 150mA. Battery-saving features include 86% typical full-load efficiency, 2mA operating quiescent supply current, and 35 μ A shutdown supply current. The shutdown mode can be directly controlled by a microprocessor via the logic-compatible SHDN pin.

The MAX751 is tested in-circuit, so output power specifications are guaranteed over all line, load, and temperature ranges. The typical operating circuit uses tiny surface-mounted components, including a miniature 22 μ H inductor, and fits into less than 0.5in².

The MAX751 uses current-mode pulse-width modulation (PWM) control to provide precise output regulation and low subharmonic noise. A fixed 170kHz oscillator frequency facilitates ripple filtering and allows for the use of tiny external capacitors.

For higher-current solutions, refer to the MAX731/MAX752 and MAX848/MAX849 data sheets and evaluation kit manuals. The MAX751 can be evaluated using the MAX731 evaluation kit (order MAX731EVKIT-DIP and a sample of the MAX751CPA).

Applications

- Local +5V Supply in +3V-Only Systems
- Cellular Phones
- RF Transmitter Supply
- Palmtop and Notebook Computers
- Battery-Powered and Hand-Held Instruments

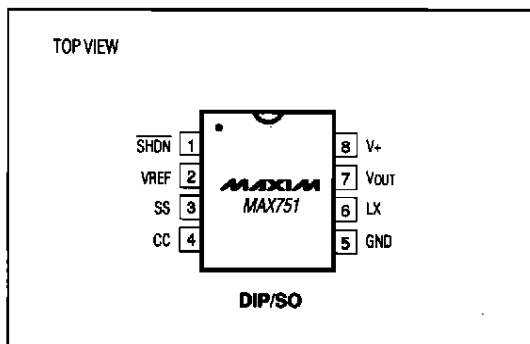
Pin Configuration**Features**

- ◆ +5V Preset Output
- ◆ Guaranteed 150mA Output Current
- ◆ 1.2V Start-Up Supply Voltage
- ◆ 86% Typical Efficiencies at Full Load
- ◆ Small 22 μ H Inductor – No Component Design Required
- ◆ 2mA Quiescent Current
- ◆ 35 μ A Logic-Controlled Shutdown Mode
- ◆ Overcurrent and Soft-Start Protection
- ◆ 170kHz High-Frequency Current-Mode PWM
- ◆ 8-Pin DIP and SO Packages

Ordering Information

PART	TEMP. RANGE	PIN-PACKAGE
MAX751CPA	0°C to +70°C	8 Plastic DIP
MAX751CSA	0°C to +70°C	8 SO
MAX751C/D	0°C to +70°C	Dice*
MAX751EPA	-40°C to +85°C	8 Plastic DIP
MAX751ESA	-40°C to +85°C	8 SO
MAX751MJA	-55°C to +125°C	8 CERDIP**

* Dice are tested at $T_A = +25^\circ\text{C}$.

** Contact factory for availability and processing to MIL-STD-883.

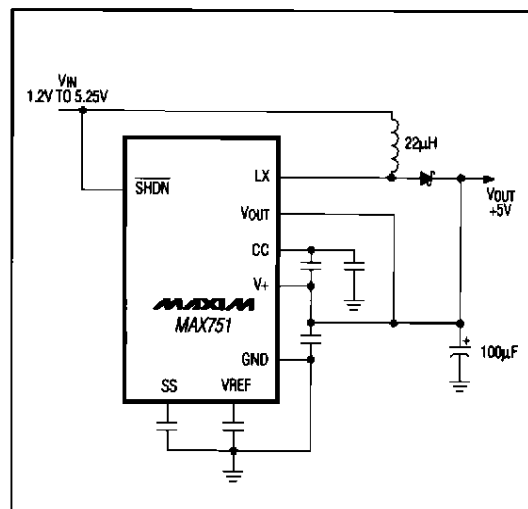
Typical Application Circuit

+5V-Output, Step-Up, Current-Mode PWM DC-DC Converter

ABSOLUTE MAXIMUM RATINGS

V+, LX to GND	-0.3V to +17V	Operating Temperature Ranges:	
V _{OUT} to GND	±25V		
SS, CC, SHDN to GND	+0.3V to (V+ + 0.3V)	MAX751C	0°C to +70°C
Peak Switch Current (I _{LX})	1.5A	MAX751E	-40°C to +85°C
Reference Current (I _{VREF})	2.5mA	MAX751MJA	-55°C to +125°C
Continuous Power Dissipation (T _A = +70°C)		Junction Temperatures	
Plastic DIP (derate 9.09mW/°C above +70°C)	727mW	MAX751C	+150°C
Wide SO (derate 5.88mW/°C above +70°C)	471mW	MAX751MJA	+175°C
CERDIP (derate 8.00mW/°C above 70°C)	644mW	Storage Temperature Range	
			-65°C to +160°C
		Lead Temperature (soldering, 10 sec)	
			+300°C

Stresses beyond those listed under "Absolute Maximum Ratings" may cause permanent damage to the device. These are stress ratings only, and functional operation of the device at these or any other conditions beyond those indicated in the operational sections of the specifications is not implied. Exposure to absolute maximum rating conditions for extended periods may affect device reliability.

ELECTRICAL CHARACTERISTICS

(Circuit of Figure 1, V_{IN} = +3V, I_{LOAD} = 0mA, T_A = T_{MIN} to T_{MAX}, typical values are at T_A = +25°C, unless otherwise noted.)

PARAMETER	CONDITIONS	MIN	TYP	MAX	UNITS
Minimum Start-Up Input Voltage	I _{LOAD} = 0mA	MAX751C	1.2	1.8	V
		MAX751E/M	1.2	2.2	
	I _{LOAD} = 150mA	MAX751C	2.2	2.7	
		MAX751E/M	2.2	3.0	
Output Voltage (Notes 1, 2)	V _{IN} = 2.7V to 5V, 0mA < I _{LOAD} < 150mA	4.75	5.00	5.25	V
Output Current	V _{IN} = 2.7V to 5V	150	200		mA
Line Regulation	V _{IN} = 2.7V to 4.5V		0.20		%/V
Load Regulation	I _{LOAD} = 0mA to 100mA		0.005		%/mA
Efficiency	V _{IN} = 3.0V, I _{LOAD} = 150mA		86		%
Supply Current	Includes switch current		2.0	3.5	mA
Standby Current	SHDN = 0V, entire circuit		35	100	µA
	SHDN = 0V, into V+		6		
SHDN Input Threshold	Input voltage high	2.0			V
	Input voltage low			0.25	
SHDN Input Leakage Current				1.0	µA
LX On Resistance			0.75		Ω
LX Leakage Current	V _{DS} = 5V		1.0		µA
Reference Voltage			1.23		V
Reference Drift			50		ppm/°C
Oscillator Frequency			170		kHz
Compensation Pin Impedance			20		kΩ

Note 1: Circuit will regulate properly with an input voltage as high as 5.25V due to the voltage drop across the external diode.
Note 2: Load-current capability is after start-up.

+5V-Output, Step-Up, Current-Mode PWM DC-DC Converter

MAX751

Typical Operating Characteristics

(Circuit of Figure 1 in bootstrapped mode, L1 = 22 μ H, T_A = +25°C, unless otherwise noted.)

**SWITCHING WAVEFORMS—
CONTINUOUS CONDUCTION**



A: SWITCH VOLTAGE (LX PIN), 2V/div
B: INDUCTOR CURRENT, 200mA/div
C: OUTPUT VOLTAGE RIPPLE, 50mV/div
V_{IN} = 3V, I_{OUT} = 150mA

**SWITCHING WAVEFORMS—
DISCONTINUOUS CONDUCTION**

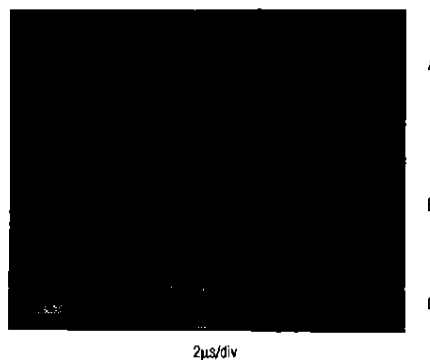

A: SWITCH VOLTAGE (LX PIN), 2V/div
B: INDUCTOR CURRENT, 200mA/div
C: OUTPUT VOLTAGE RIPPLE, 50mV/div
V_{IN} = 3V, I_{OUT} = 150mA

LINE-TRANSIENT RESPONSE



A: V_{IN}, 2V/div, 3V TO 4V
B: V_{OUT}, 200mV/div, AC-COUPLED
I_{OUT} = 180mA

LOAD-TRANSIENT RESPONSE

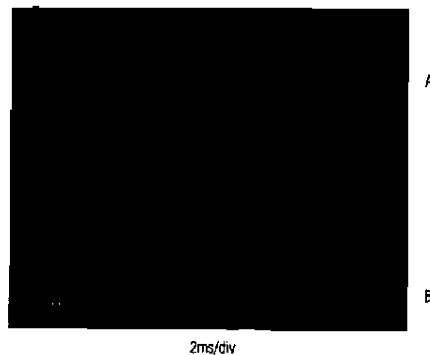

A: V_{OUT}, 50mV/div
B: I_{OUT}, 100mA/div, 0mA TO 200mA
V_{IN} = 3V

+5V-Output, Step-Up, Current-Mode PWM DC-DC Converter

Typical Operating Characteristics (continued)

(Circuit of Figure 1 in bootstrapped mode, L1 = 22 μ H, T_A = +25°C, unless otherwise noted.)

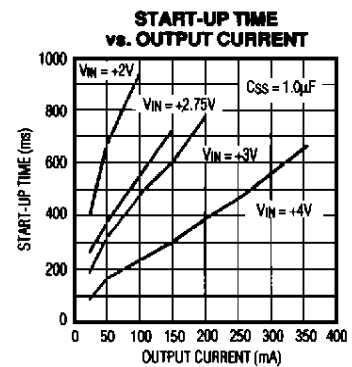
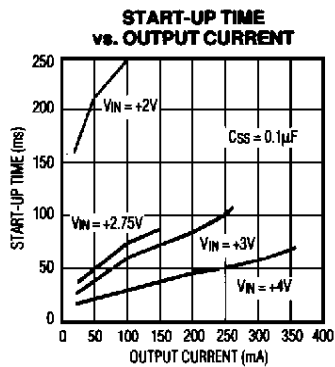
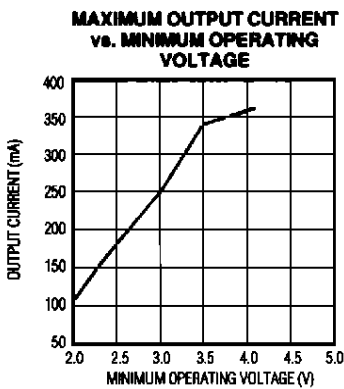
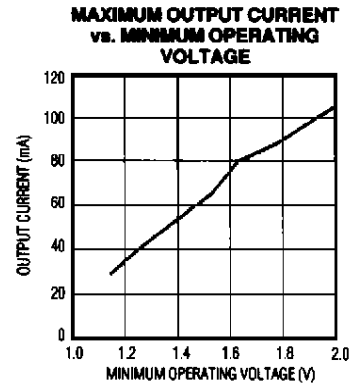
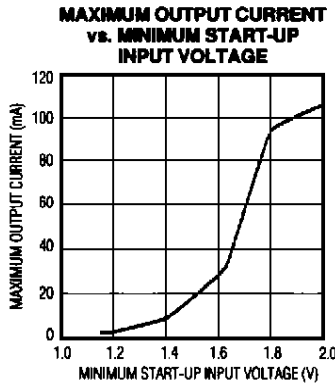
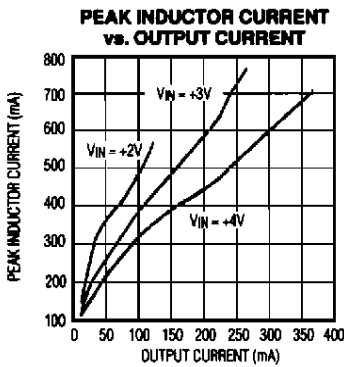
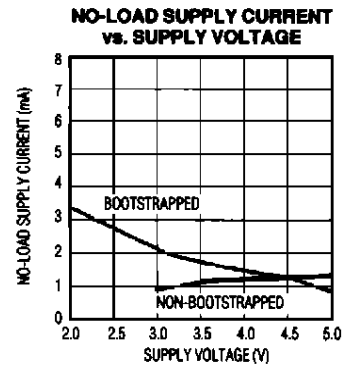
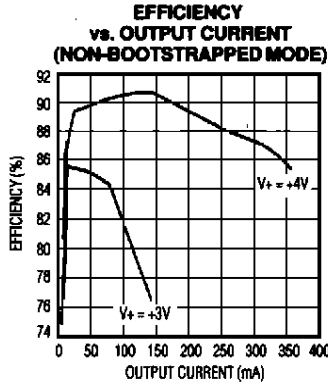
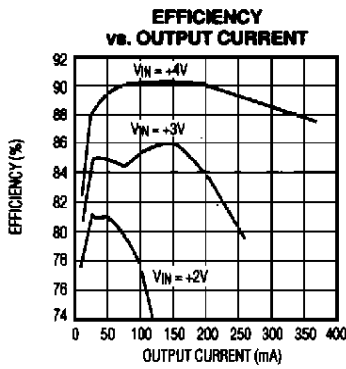

+5V-Output, Step-Up, Current-Mode PWM DC-DC Converter

MAX751

Typical Operating Characteristics (continued)

(Circuit of Figure 1 in bootstrapped mode, L1 = 22 μ H, T_A = +25°C, unless otherwise noted.)

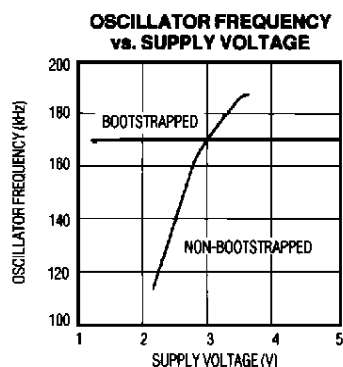
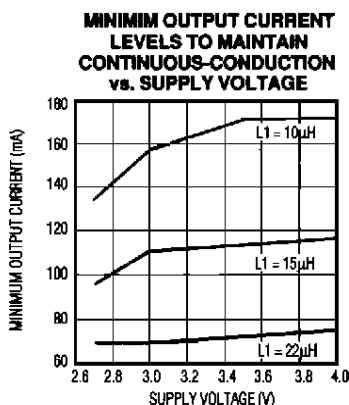

Pin Description

PIN	NAME	FUNCTION
1	SHDN	Shutdown – active low. Tie to ground to power down the IC; tie to V+ for normal operation. The output power FET is held off when SHDN is low.
2	VREF	Reference Voltage Output (+1.23V) – supplies up to 100 μ A for external loads.
3	SS	Soft-Start. Capacitor between SS and GND provides soft-start and short-circuit protection.
4	CC	Compensation Capacitor Input. Externally compensates the outer feedback loop.
5	GND	Ground
6	LX	Drain of internal N-channel power MOSFET
7	VOUT	Output-Voltage Sense Input
8	V+	Supply-Voltage Input. Tie to VOUT for bootstrapped operation; connect input voltage source to V+ for non-bootstrapped operation.

Detailed Description

Operating Principle

The MAX751 switch-mode regulator uses a current-mode PWM controller in a simple boost regulator configuration to step up an unregulated DC voltage. The MAX751 converts a voltage ranging from 1.2V to 5.25V, to a 5V output. The current-mode PWM architecture provides cycle-by-cycle current limiting and excellent load-transient response characteristics.

The controller consists of two feedback loops: an inner (current) loop that monitors the switch current through the current-sense resistor (RS) and amplifier, and an outer (voltage) loop that monitors the output voltage with an error amplifier (Figure 1). The inner loop performs cycle-by-cycle current limiting, truncating the power transistor on time when the switch current reaches a threshold determined by the outer loop. For example, a sagging output voltage produces an error signal that raises the threshold at the error amp output. This allows the inductor current (which generates the current-sense amp output voltage) to increase, resulting in more energy stored and transferred during each cycle.

Input Voltage Considerations

The input voltage range has three important components: no-load start-up voltage, full-load start-up voltage and minimum operation voltage. The no-load starting voltage is typically 1.2V, but if a load is added, the start-up voltage increases (see Maximum Output Current vs. Minimum Start-Up Input Voltage in the *Typical Operating Characteristics*). Above 2V, the Maximum Output Current vs. Start-Up Input Voltage graph is identical to the Maximum Output Current vs. Minimum Operating Voltage graph. With a 2.7V input voltage, the MAX751 is guaranteed to start up and regulate with a 150mA load.

The minimum operating voltage is the voltage down to which the MAX751 will continue to provide a regulated 5V output. This voltage is very important in battery-operated equipment because it indicates the voltage to which the battery can discharge without losing output regulation. The Maximum Output Current vs. Minimum Operat-

+5V-Output, Step-Up, Current-Mode PWM DC-DC Converter

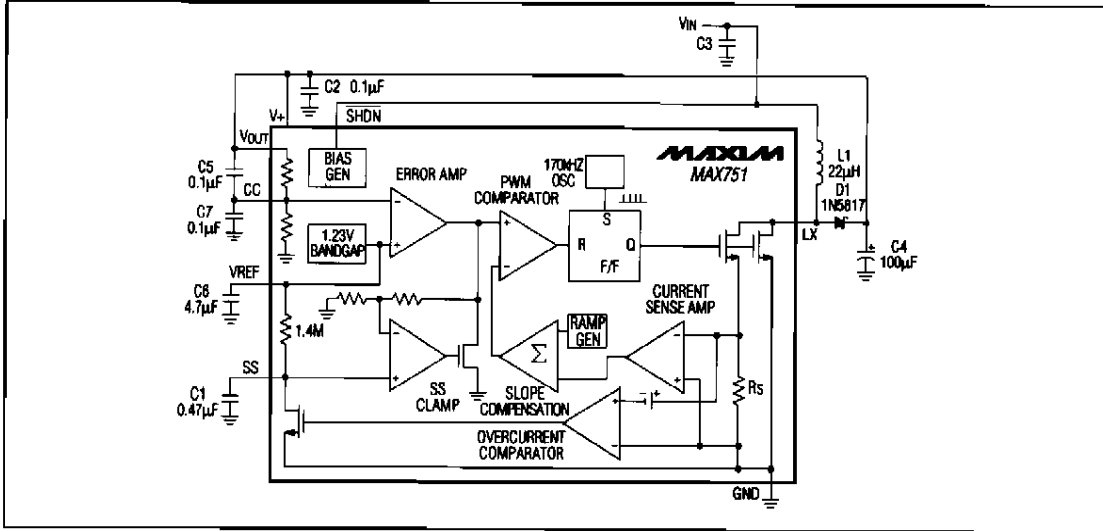

Figure 1. Detailed Block Diagram with External Components, Bootstrapped Mode

ing Voltage graph in the *Typical Operating Characteristics* shows minimum operating values in bootstrapped mode.

Input voltages as high as 5.25V can be applied without damage, but regulation is lost when the input exceeds the normal regulated output. This happens because a DC path through the inductor and diode produces an output voltage one diode drop less than the input voltage. (The MAX751 senses this high output and stops switching.) This path exists even with the IC removed from the circuit.

Bootstrapped vs. Non-Bootstrapped Mode

Figure 2 shows the "bootstrapped" circuit for the MAX751. In bootstrapped mode, V+ is tied to VOUT so that the MAX751 operates from the output it generates, providing increased gate-drive voltage for the internal power switch. In bootstrapped mode, the MAX751 furnishes 150mA from an input as low as 2.2V.

In Figure 3's non-bootstrapped mode circuit, the input voltage is applied to the V+ pin. In non-bootstrapped mode, the MAX751 operates with a lower supply current, but has lower output power capability than in bootstrapped mode due to the decreased gate-drive voltage. This mode is best in applications where small load currents are required and the input voltage is greater than 2.7V (which provides adequate gate drive for the power

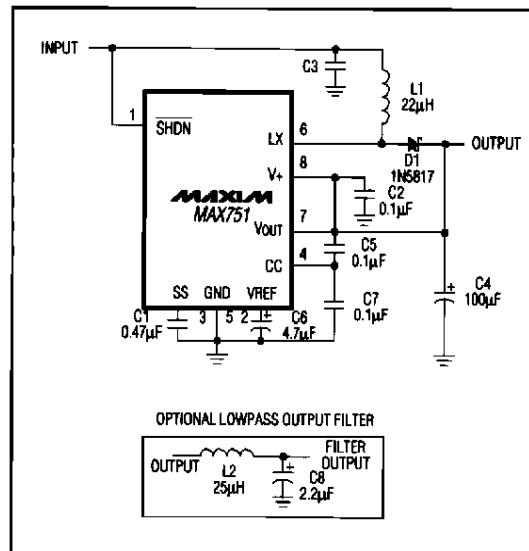

Figure 2. Standard-Boost Application Circuit (Bootstrapped Mode)

+5V-Output, Step-Up, Current-Mode PWM DC-DC Converter

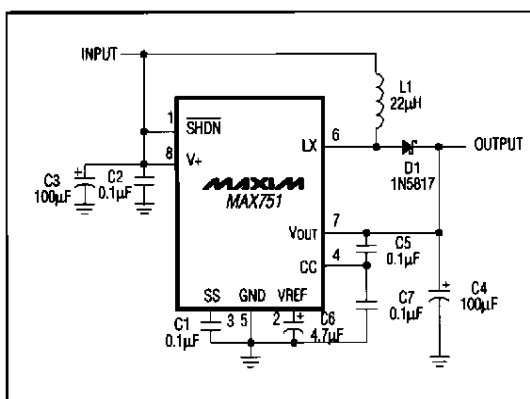

Figure 3. Standard-Boost Application Circuit (Non-Bootstrapped Mode)

FET). A 100µF bypass capacitor in parallel with a 0.1µF capacitor is recommended at the V+ pin.

Programmable Soft-Start

The Soft-Start (SS) pin limits power-up current, allowing proper start-up with a load on the output. On power-up, the MAX751 uses the maximum switch duty cycle to draw excessive current to charge the output filter capacitor, and supply current to the load. In this case, the device may stall and the output voltage will not rise to 5V. A capacitor (between 0.047µF and 5µF) is required on SS to ensure proper start-up. The larger the capacitor, the slower the internal current-limit threshold is raised, allowing more time for start-up. As the voltage on the SS pin increases, the voltage at the SS clamp output increases, which in turn increases the current-limit threshold (Figure 1).

Overcurrent Limiting

When the peak switch current exceeds approximately 1.5A, the output stage is turned off by the inner loop cycle-by-cycle current-limiting action, and the overcurrent comparator signals the control logic to initiate an SS cycle. On each clock cycle, the output FET turns on again and attempts to deliver current until cycle-by-cycle or overcurrent limits are exceeded. Note that the SS capacitor must be at least 0.01µF for overcurrent protection to function properly.

The overcurrent limit protects the MAX751, but does not interrupt the DC path through the inductor and the diode. Do not exceed the maximum current ratings of the inductor and diode.

Shutdown

Shutdown ($\overline{\text{SHDN}}$) is a logic level active-low input. When the voltage applied to $\overline{\text{SHDN}}$ is greater than 2V, the MAX751 is guaranteed to operate normally. Connect $\overline{\text{SHDN}}$ to V+ for normal operation. Keeping $\overline{\text{SHDN}}$ at ground holds the MAX751 in shutdown mode. In shutdown mode, the output power FET is off, the internal reference is turned off (which causes the soft-start capacitor to discharge), but there is an external path from V+ to the load through the inductor and diode, and another path from V+ to GND through the inductor, diode, and internal feedback resistors. Typical device standby current in shutdown mode is 35µA.

Operation Modes

Continuous-Current Mode: In continuous mode, current always flows in the inductor, and the control circuit adjusts the switch's duty-cycle on a cycle-by-cycle basis to maintain regulation without exceeding the switch-current capability. Continuous mode is a function of the input-output voltage differential, the inductor value, and the load current. This mode provides excellent load-transient response. With light loads, the MAX751 automatically operates in discontinuous mode. As the load increases, the inductor current rises, and at some point the circuit enters continuous mode. Continuous mode operation gives a cleaner output than discontinuous or pulse-skipping modes, because peak-to-peak ripple amplitude is minimized and the ripple frequency is fixed at the oscillator frequency, making output noise easy to filter.

Discontinuous-Current Mode: In discontinuous mode, current through the inductor starts at zero, rises to a peak value, then ramps down to zero on each cycle. Although efficiency is still excellent, the output ripple increases slightly and the switch waveforms display ringing at the inductor's self-resonant frequency. This ringing is to be expected.

Pulse-Skipping Mode: At load currents under a few milliamperes, even discontinuous-current mode tends to put more energy into the coil than the load requires, so the controller changes to pulse-skipping mode, in which regulation is achieved by skipping entire cycles. Efficiency is still good, typically 70% to 80%, reduced in part because the MAX751 quiescent supply current becomes a significantly larger fraction of the total current when load currents are low. Pulse-skipping switch waveforms can be irregular, and the output ripple contains a low-frequency component that may exceed 50mV. Larger, low-ESR filter capacitors can help reduce the ripple voltage in critical applications.

MAX751

+5V-Output, Step-Up, Current-Mode PWM DC-DC Converter

Applications Information

Figure 2 shows the standard step-up application circuit for continuous mode operation. This circuit starts up and operates with inputs from 1.2V to 5.25V. The output current capability is a function of the input voltage (*Typical Operating Characteristics*).

Inductor Selection

A 22 μ H inductor is optimal for most MAX751 designs. Do not exceed the inductor's incremental saturation (see Peak Inductor Current vs. Output Current, *Typical Operating Characteristics*). Table 1 lists various inductor types and suppliers. The listed surface-mount inductors' efficiencies are nearly equivalent to those of the larger-sized, through-hole inductors.

Output Filter Capacitor Selection

The primary criterion for selecting the output filter capacitor is low equivalent series resistance (ESR). The product of the inductor current variation and the output capacitor's ESR determines the high-frequency ripple observed on the output voltage. The output filter capacitor's ESR should be minimized to maintain AC stability. Refer to Table 1 for suggested capacitor suppliers.

In the standard application of Figure 2, the output capacitor value should be at least 100 μ F in order to maintain stability at full loads. 150 μ F capacitors (MAXC001) are available from Maxim in production quantities. Lower capacitor values can be used with lighter loads.

Other Components

Use a Schottky diode with a continuous-current rating of at least 500mA for full-load (≥ 200 mA) operation. The 1N5817 is a good choice. The two compensation capacitor values at the CC input are critical because they have been selected to provide the best transient response. The input capacitor (C3 in Figures 1, 2, and 4) may be omitted if the power supply impedance is very low. Otherwise, up to 100 μ F may be necessary.

Soft-Start Considerations

The supply voltage must rise at a faster rate than the voltage at the SS pin to avoid defeating SS. Table 2 lists SS timing characteristics for selected capacitor values. The output voltage sags if soft-start operation is defeated. With low input voltages and high load currents, if the power supply glitches momentarily, the MAX751 may not restart properly. This occurs if SS has not discharged before power is reapplied, thus defeating SS operation. If an input voltage glitch causes the MAX751 to stall, remove the load or restart the MAX751 to return the circuit to normal operation. Otherwise, use Figure 4's circuit.

Table 1. Component Suppliers

PRODUCTION METHOD	INDUCTORS	CAPACITORS
Surface Mount	Sumida CD54-220 (22 μ H) Coiltronics CTX20-1	Matsuo 267-series
Miniature Through-Hole	Sumida RCH654-220	Sanyo Os-Con Os-Con-series Low-ESR organic semiconductor
Low-Cost Through-Hole	Renco RL 1284-22 Coilcraft PCH-27-223	Maxim MAXC001 150 μ F, low-ESR electrolytic Nichicon PL-series Low-ESR electrolytic United Chemi-Con LXF-series

Coilcraft	(708) 639-6400
Coiltronics	(561) 241-7876
Matsuo USA	(714) 969-6291, FAX (714) 960-6492
Matsuo Japan	(06) 332-0871
Nichicon	(708) 843-7500, FAX (708) 843-2798
Renco	(516) 586-5566, FAX (516) 586-5562
Sanyo Os-Con, USA	(619) 661-6835
Sanyo Os-Con, Japan	(0720) 70-1005, FAX (0720) 70-1174
Sumida USA	(708) 956-0666
Sumida Japan	(03) 3607-5111, FAX (03) 3607-5428
United Chemi-Con	(708) 696-2000, FAX (708) 640-6311

Table 2. Typical Soft-Start Timing

$V_{IN} = 3V, C_{OUT} = 100\mu F$		
C_{SS} (μF)	Rise-Time Time Constant (t_R) (sec)	Fall-Time Time Constant (t_F) (sec)
0.047	60m	320m
0.1	140m	400m
0.47	600m	1.1
1.0	1.3	1.7
2.2	3.0	4.0
4.7	6.2	8.0

+5V-Output, Step-Up, Current-Mode PWM DC-DC Converter

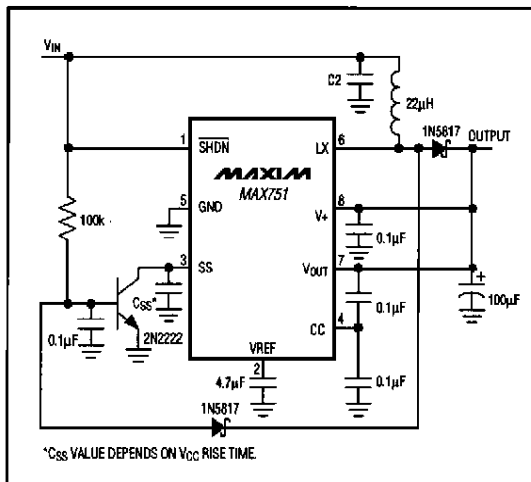

Figure 4. Rapid Soft-Start Discharge Circuit

The power-up SS charge rate is determined by the time constant formed by the SS capacitor and the internal $1.4\text{M}\Omega \pm 25\%$ resistor between VREF and SS (Figure 1).

Output-Ripple Filtering

An optional lowpass filter (Figure 2 inset) can be added to the output to reduce output ripple to about 5mVp-p . The cutoff frequency of the filter shown is 21kHz . Since the filter inductor is in series with the circuit output, minimize its resistance to avoid excessive voltage drop. The feedback must be taken before the filter, not after.

Table 3. PWM DC-DC Converters

DEVICE	FUNCTION	OUTPUT VOLTAGE (V)	PIN-PACKAGE
MAX730	Step-Down	+5	8 DIP, 8 SO
MAX731	Step-Up	+5	8 DIP, 16 SO
MAX732	Step-Up	+12	8 DIP, 16 SO
MAX733	Step-Up	+15	8 DIP, 16 SO
MAX734	Step-Up	+12	8 DIP, 8 SO
MAX735	Inverting	-5	8 DIP, 8 SO
MAX736	Inverting	-12	14 DIP, 16 SO
MAX737	Inverting	-15	14 DIP, 16 SO
MAX738	Step-Down	+5	8 DIP, 16 SO
MAX739	Step-Down	-5	14 DIP, 16 SO
MAX741	Controller	Adjustable	20 DIP, 20 SSOP
MAX750	Step-Down	Adjustable	8 DIP, 8 SO
MAX752	Step-Up	Adjustable	8 DIP, 16 SO
MAX755	Inverting	Adjustable	8 DIP, 8 SO
MAX758	Step-Down	Adjustable	8 DIP, 16 SO
MAX759	Inverting	Adjustable	14 DIP, 16 SO

Printed Circuit Layout

Printed circuit board layout is not critical, except to ensure quiet operation. Bypass capacitors, particularly between V+ and GND, should be located as close to the device as possible to prevent instability and noise pickup. The Schottky diode leads should also be kept short to prevent fast rise-time pulses in the output. High-current paths should be as short as possible. A ground plane is recommended, but not necessary. Minimize stray capacitance at the LX node. The MAX751 can be evaluated using the MAX731EVKIT-DIP (order MAX751CPA sample when ordering the kit).

MAX751

+5V-Output, Step-Up, Current-Mode PWM DC-DC Converter

MAX751

Chip Topography

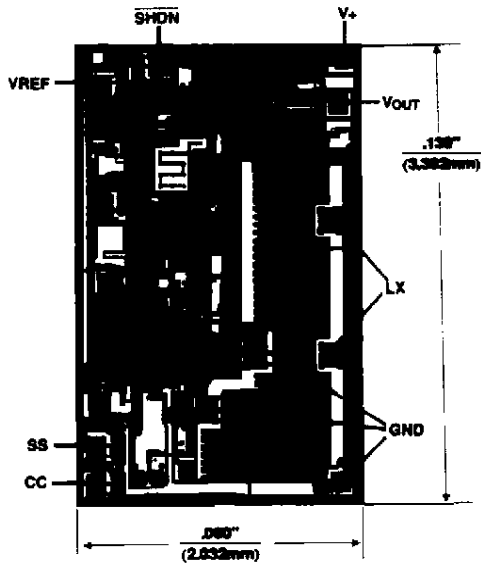

CONNECT SUBSTRATE TO V+;
TRANSISTOR COUNT: 222

+5V-Output, Step-Up, Current-Mode PWM DC-DC Converter

Package Information

MAX751

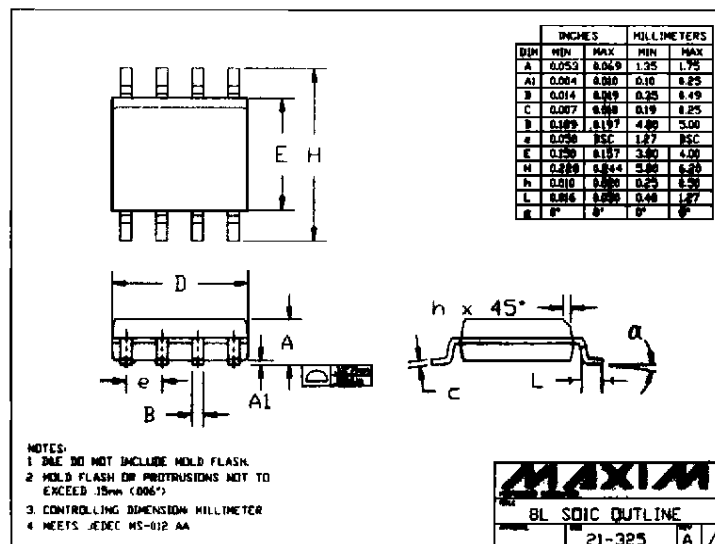
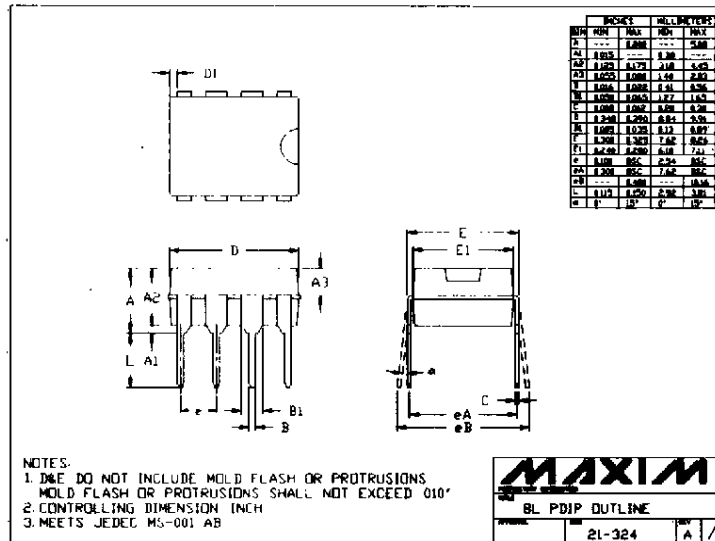

MAX751

+5V-Output, Step-Up, Current-Mode PWM DC-DC Converter

Package Information (continued)

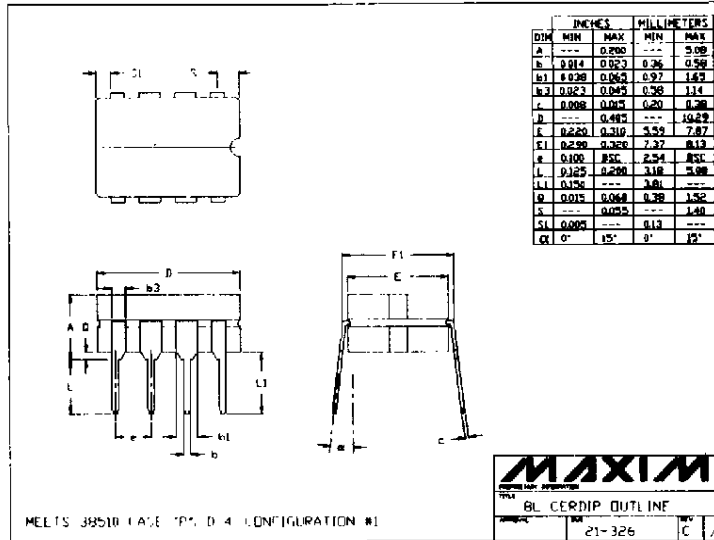

Maxim cannot assume responsibility for use of any circuitry other than circuitry entirely embodied in a Maxim product. No circuit patent licenses are implied. Maxim reserves the right to change the circuitry and specifications without notice at any time.

12 **Maxim Integrated Products, 120 San Gabriel Drive, Sunnyvale, CA 94086 (408) 737-7600**

© 1996 Maxim Integrated Products Printed USA **MAXIM** is a registered trademark of Maxim Integrated Products.