

Datasheet

Compact, single-point devices for error-proofing of bin-picking operations

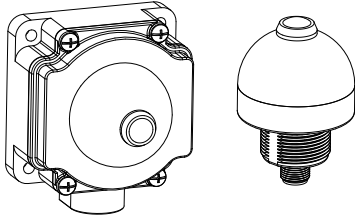

- Rugged, cost-effective, and easy-to-install solutions for error-proofing and parts-verification applications
- Compact devices are completely self-contained - no controller needed
- Illuminated dome provides a big, easy-to-see green, red or yellow job light
- Push-button and passive-actuation models available
- Choose NPN or PNP output, depending on model
- Fully encapsulated IP67 construction — ideal for use in abusive environments; rated to IP69K, depending on installation; see specifications
- Immune to ambient light, EMI, and RFI interference
- 12 to 30 V dc operation
- 5-pin M12 PUR pigtail (150 mm) with quick disconnect fitting



WARNING: Not To Be Used for Personnel Protection

Never use this device as a sensing device for personnel **protection**. Doing so could lead to serious injury or death. This device does not include the self-checking redundant circuitry necessary to allow its use in personnel safety applications. A sensor failure or malfunction can cause either an energized or de-energized sensor output condition.

Models

Model ¹	Sensing Mode / LED	Housing	Range	Output ²	Job Light
K50RPLPGRYC3QPMA	Polarized retroreflective, visible red, 680 nm		2 m (6 ft)	PNP, normally closed	Green/ yellow/ red
K50RPLPGRYC4QPMA					
K50APFF50GRYC3QPMA	Fixed field, infrared, 880 nm	50 mm dome 30 mm mount polycarbonate	50 mm cutoff	PNP, normally open	
K50APFF50GRYC4QPMA					
K50APFF100GRYC3QPMA			100 mm cutoff		
K50APFF100GRYC4QPMA					
K50APPBGRYC3QPMA	Push button	50 mm dome Flat or DIN- mount polycarbonate	—		
K50APPBGRYC4QPMA					
K80APPBGRYC3QPMA					
K80APPBGRYC4QPMA					

A model with a quick disconnect fitting requires a mating cable (see [Accessories](#) on page 4).

Overview

The solid-state output interfaces to a system controller, which is pre-programmed for a specific sequence of tasks. Mounted in or near each bin in an assembler's work station, the sensor job light signals the assembler:

- Which bins contain items to be picked in a given operation; and
- In what order they should be picked.

As the assembler takes a part in sequence and pushes the button, the sensor senses that the part was removed and sends an output signal to the controller. The controller verifies if the correct part was taken and may respond by turning that job light OFF, activating the job light of the next bin in the sequence.

¹ The 5-pin 150 mm M12/Euro-style PUR pigtail quick disconnect models are listed.

- To order the 2 m (6 ft) PVC cable model, omit the suffix "QPMA" from the model number (e.g., "K50RPLPGRYC3").
- To order the 9 m (30 ft) PVC cable model, replace the suffix "QPMA" with "W/30" (e.g., "K50RPLPGRYC3 W/30").
- To order the 150 mm (5.9 in) PVC pigtail with 5-pin M12/Euro-style fitting, replace the suffix "QPMA" with "QP" (e.g., "K50RPLPGRYC3QP").

² PNP models only are listed. For other output types, contact the Factory.



If multiple parts are to be removed from one bin, the job light may remain ON until the appropriate number of signals is returned to the controller. If an incorrect part is selected, the control system may be wired to signal an alarm for the assembler and/or a supervisor, or it may be programmed to interpret the action as a call for parts.

Indicator and Output Behavior



Note: "C3" and "C4" models as referenced in the table pertain to a part of the product model number, immediately preceding the QPMA designation.

Sensor Conditions		Job Light		Output Signal Status
		C3 Models	C4 Models	
Job input active	Hand/pick absent	On Green	On Green	Off
	Hand/pick present	On Yellow	On Yellow until job input is removed	On
No job input	Hand/pick absent	Off	Off	Off
	Hand/pick present	On Red	On Red for 5 seconds after hand/pick is removed	On

Wiring Diagram

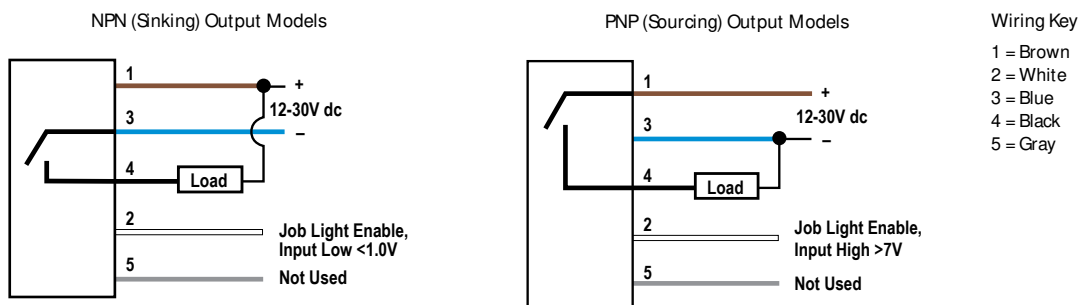

Note: Cabled wiring diagrams are shown. Quick disconnect (QD) wiring diagrams are functionally identical.

Specifications

Supply Voltage and Current

- 12 to 30 V dc (10% max. ripple)
- < 90 mA max. current at 12 V dc (exclusive of load)
- < 60 mA max. current at 30 V dc (exclusive of load)

Supply Protection and Circuitry

- Protected against transient voltages (fast-transient and over-voltage) and reverse polarity

Output Configuration

- 1 current sinking (NPN) transistor or 1 current sourcing (PNP) transistor, depending on model. Retroreflective models have normally closed (N.C.) output; all other models have normally open (N.O.) output.

Output Rating

- Max. load: 150 mA
- ON-state saturation voltage:
- PNP models: < 2 V at 10 mA dc; < 2.5 V at 150 mA dc
- NPN models: < 1.5 V at 10 mA dc; < 2 V at 150 mA dc
- OFF-state leakage current: < 10 μ A at 30 V dc

Output Protection

- Protected against false pulse on power-up and continuous overload or short circuit of output

Output Response Time

- 5 milliseconds ON, 500 ms leading edge OFF

Power-Up Output Delay Time

- 300 ms

Job Light Enable

- Input impedance: 8K Ohms
- Sinking – Input low < 1.0 V
- Sourcing – Input high > 7 V

Construction

- Base: polycarbonate
- Translucent dome: polycarbonate
- Push button: thermoplastic
- Lens: polycarbonate or acrylic

Connections

- 150 mm pigtail with 5-pin M12/Euro-style quick disconnect fitting (QPMA); accessory cordset required for QD models.

Ambient Light Immunity

- Up to 5,000 lux

Indicators

- Entire translucent dome provides indicator light:
- Job (Pick) – Green
- Pick Sensed – Yellow
- Mispick – Red

EMI-RFI Immunity

Immune to EMI and RFI noise sources, per IEC947-5-2.

Environmental Rating

Fully encapsulated; IEC IP67
 Integral QD models meet DIN 40050 (IP69K) when using IP69K-rated cables;
 pigtail and cable models meet IP69K when mounted with conduit

Operating Conditions

-40 °C to +50 °C (-40 °F to +122 °F)
 90% at +50 °C maximum relative humidity (non-condensing)

Certifications



Required Overcurrent Protection



WARNING: Electrical connections must be made by qualified personnel in accordance with local and national electrical codes and regulations.

Overcurrent protection is required to be provided by end product application per the supplied table.
 Overcurrent protection may be provided with external fusing or via Current Limiting, Class 2 Power Supply.
 Supply wiring leads < 24 AWG shall not be spliced.
 For additional product support, go to www.bannerengineering.com.

Supply Wiring (AWG)	Required Overcurrent Protection (Amps)
20	5.0
22	3.0
24	2.0
26	1.0
28	0.8
30	0.5

Dimensions

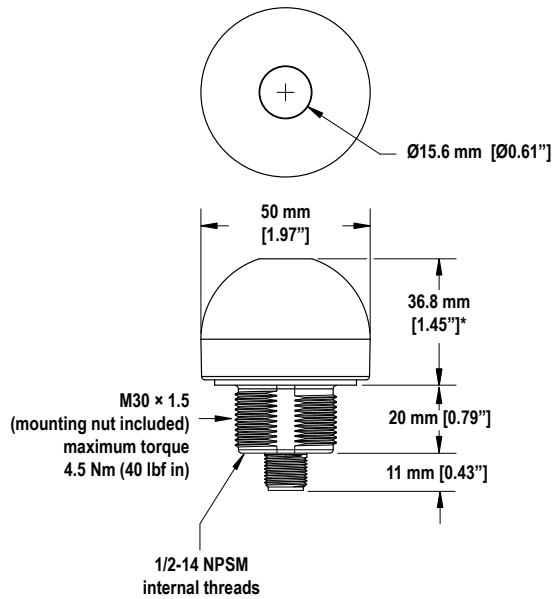
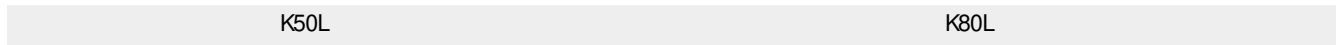

* For push-button models, this dimension is 44.2 mm (1.74 in)

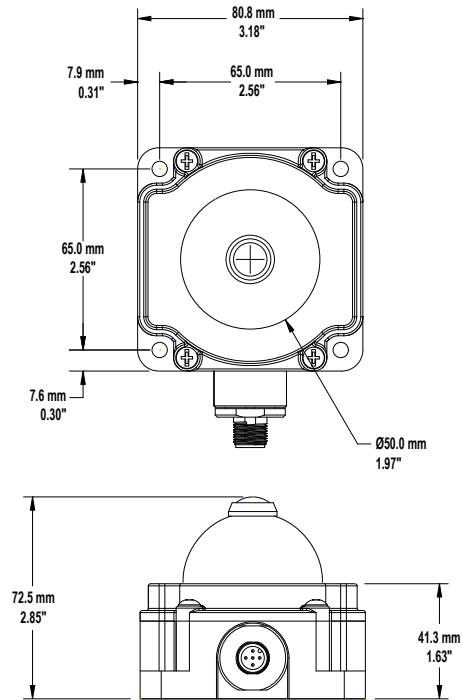

Accessories

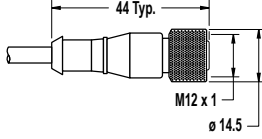
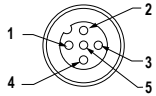
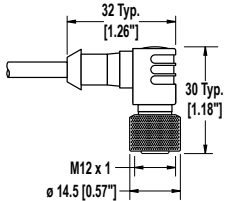
5-Pin Threaded M12/Euro-Style Cordsets—Single Ended				
Model	Length	Style	Dimensions	Pinout (Female)
MQDC1-501.5	0.50 m (1.5 ft)	Straight		 1 = Brown 2 = White 3 = Blue 4 = Black 5 = Gray
MQDC1-506	1.83 m (6 ft)			
MQDC1-515	4.57 m (15 ft)			
MQDC1-530	9.14 m (30 ft)			
MQDC1-506RA	1.83 m (6 ft)	Right-Angle		
MQDC1-515RA	4.57 m (15 ft)			
MQDC1-530RA	9.14 m (30 ft)			

Brackets (All measurements are listed in millimeters [inches], unless noted otherwise.)

SMB30A

- Right-angle bracket with curved slot for versatile orientation
- Clearance for M6 (1/4in) hardware
- Mounting hole for 30 mm sensor
- 12-ga. stainless steel

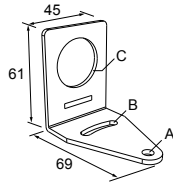

Hole center spacing: A to B=40
Hole size: A=ø 6.3, B= 27.1 x 6.3, C=ø 30.5

SMB30SC

- Swivel bracket with 30 mm mounting hole for sensor
- Black reinforced thermoplastic polyester
- Stainless steel mounting and swivel locking hardware included

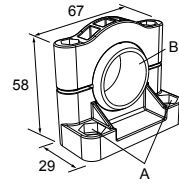

Hole center spacing: A=ø 50.8
Hole size: A=ø 7.0, B=ø 30.0

SMB30FA

- Swivel bracket with tilt and pan movement for precise adjustment
- Mounting hole for 30 mm sensor
- 12-ga. 304 stainless steel
- Easy sensor mounting to extrude rail T-slot
- Metric and inch size bolt available

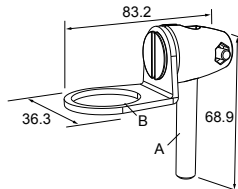

Bolt thread: SMB30FA, A= 3/8 - 16 x 2 in; SMB30FAM10, A= M10 - 1.5 x 50
Hole size: B= ø 30.1

SMBAMS30RA

- Right-angle SMBAMSseries bracket
- 30 mm hole for mounting sensors
- Articulation slots for 90°+ rotation
- 12-ga. (2.6 mm) cold-rolled steel

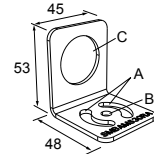

Hole center spacing: A=26.0, A to B=13.0
Hole size: A=26.8 x 7.0, B=ø 6.5, C=ø 31.0

SMB30MM

- 12-ga. stainless steel bracket with curved mounting slots for versatile orientation
- Clearance for M6 (1/4in) hardware
- Mounting hole for 30 mm sensor

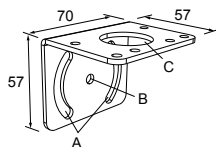

Hole center spacing: A = 51, A to B= 25.4
Hole size: A = 42.6 x 7, B = ø 6.4, C = ø 30.1

SMBAMS30P

- Flat SMBAMSseries bracket
- 30 mm hole for mounting sensors
- Articulation slots for 90°+ rotation
- 12-ga. 300 series stainless steel

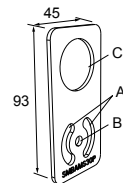

Hole center spacing: A=26.0, A to B=13.0
Hole size: A=26.8 x 7.0, B=ø 6.5, C=ø 31.0

Brackets (All measurements are listed in millimeters [inches], unless noted otherwise.)

SMBDX80DIN

Black reinforced thermoplastic
Bracket for mounting on a 35 mm DIN rail

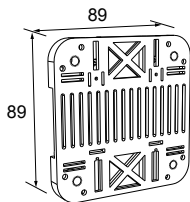

Retroreflective Targets

BRT-2X2

- Square, acrylic target
- Reflectivity factor: 1.0
- Max. temperature: +50 °C (+122 °F)
- Optional brackets are available
- Approximate size: 51 mm x 51 mm

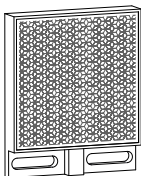

BRT-35X35B

- Square, acrylic target
- Reflectivity Factor: 1.3
- Temperature: -20 °C to +60 °C (-4 °F to +140 °F)
- Approximate size: 35 mm x 35 mm

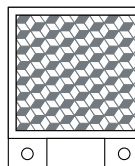

BRT-51X51BM

- Square, acrylic target
- Reflectivity Factor: 1.5
- Temperature: -20 °C to +50 °C (-4 °F to +122 °F)
- Micro-prism geometry
- Optional brackets are available
- Approximate size: 51 mm x 51 mm

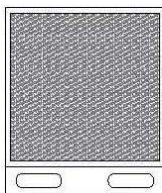

BRT-50D

- Round, acrylic target with mounting stud
- Reflectivity factor: 1.0
- Temperature: -20 °C to +60 °C (-4 °F to +140 °F)
- Optional brackets are available
- Size: 50.8 mm diameter

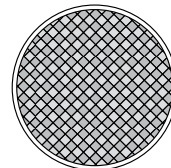

BRT-100X18A

- Rectangular, acrylic target
- Reflectivity factor: 1.4
- Temperature: -20 °C to +60 °C (-4 °F to +140 °F)
- Approximate size: 18.5 mm x 120 mm



Note: For a complete selection of retroreflective targets, see www.bannerengineering.com.

Retroreflective Tape

Model	Reflectivity Factor	Maximum Temperature	Size
BRT-THG-1-100	0.7	+60 °C (+140 °F)	25 mm (1 in) wide, 2.5 m (100 in) long
BRT-THG-2-100	0.7	+60 °C (+140 °F)	50 mm (2 in) wide, 2.5 m (100 in) long
BRT-THG-3-100	0.7	+60 °C (+140 °F)	75 mm (3 in) wide, 2.5 m (100 in) long
BRT-TVHG-2X2	0.8	+60 °C (+140 °F)	50 x 50 mm

Banner Engineering Corp. Limited Warranty

Banner Engineering Corp. warrants its products to be free from defects in material and workmanship for one year following the date of shipment. Banner Engineering Corp. will repair or replace, free of charge, any product of its manufacture which, at the time it is returned to the factory, is found to have been defective during the warranty period. This warranty does not cover damage or liability for misuse, abuse, or the improper application or installation of the Banner product.

THIS LIMITED WARRANTY IS EXCLUSIVE AND IN LIEU OF ALL OTHER WARRANTIES WHETHER EXPRESS OR IMPLIED (INCLUDING, WITHOUT LIMITATION, ANY WARRANTY OF MERCHANTABILITY OR FITNESS FOR A PARTICULAR PURPOSE), AND WHETHER ARISING UNDER COURSE OF PERFORMANCE, COURSE OF DEALING OR TRADE USAGE.

This Warranty is exclusive and limited to repair or, at the discretion of Banner Engineering Corp., replacement. IN NO EVENT SHALL BANNER ENGINEERING CORP. BE LIABLE TO BUYER OR ANY OTHER PERSON OR ENTITY FOR ANY EXTRA COSTS, EXPENSES, LOSSES, LOSS OF PROFITS, OR ANY INCIDENTAL, CONSEQUENTIAL OR SPECIAL DAMAGES RESULTING FROM ANY PRODUCT DEFECT OR FROM THE USE OR INABILITY TO USE THE PRODUCT, WHETHER ARISING IN CONTRACT OR WARRANTY, STATUTE, TORT, STRICT LIABILITY, NEGLIGENCE, OR OTHERWISE.

Banner Engineering Corp. reserves the right to change, modify or improve the design of the product without assuming any obligations or liabilities relating to any product previously manufactured by Banner Engineering Corp. Any misuse, abuse, or improper application or installation of this product or use of the product for personal protection applications when the product is identified as not intended for such purposes will void the product warranty. Any modifications to this product without prior express approval by Banner Engineering Corp will void the product warranties. All specifications published in this document are subject to change; Banner reserves the right to modify product specifications or update documentation at any time. Specifications and product information in English supersede that which is provided in any other language. For the most recent version of any documentation, refer to: www.bannerengineering.com.