

SS8050-G (NPN)

RoHS Device

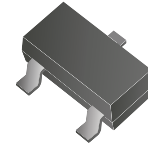
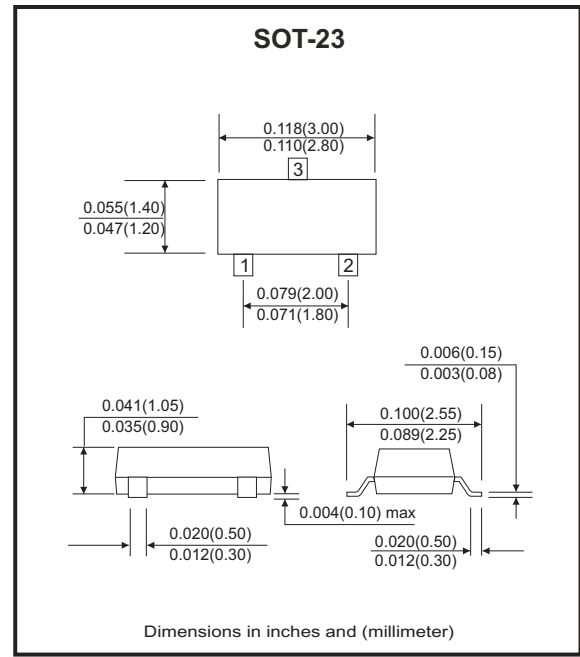
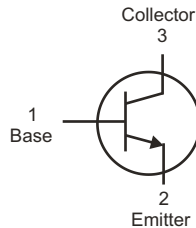

Diagram:

- 1 : BASE
- 2 : EMITTER
- 3 : COLLECTOR



Maximum Ratings (at TA=25°C unless otherwise noted)

Parameter	Symbol	Value	Unit
Collector-Base voltage	V _{CB0}	40	V
Collector-Emitter voltage	V _{CEO}	25	V
Emitter-Base voltage	V _{EB0}	5	V
Collector current	I _C	1.5	A
Collector power dissipation	P _C	300	mW
Thermal resistance from junction to ambient	R _{θJA}	417	°C/W
Junction temperature	T _J	150	°C
Storage temperature	T _{stg}	-55~+150	°C

Electrical Characteristics (at TA=25°C unless otherwise noted)

Parameter	Conditions	Symbol	Min	Typ	Max	Unit
Collector-Base breakdown voltage	I _C = 100μA , I _E = 0	V _{(BR)CBO}	40	-	-	V
Collector-Emitter breakdown voltage	I _C = 0.1mA , I _B = 0	V _{(BR)CEO}	25	-	-	V
Emitter-Base breakdown voltage	I _E = 100μA , I _C = 0	V _{(BR)EBO}	5	-	-	V
Collector cut-off current	V _{CB} = 40V , I _E = 0	I _{CB0}	-	-	0.1	μA
Collector cut-off current	V _{CE} = 20V , I _E = 0	I _{CEO}	-	-	0.1	μA
Emitter cut-off current	V _{EB} = 5V , I _C = 0	I _{EBO}	-	-	0.1	μA
DC current gain	V _{CE} = 1V , I _C = 100mA	h _{FE(1)}	200	-	350	
	V _{CE} = 1V , I _C = 800mA	h _{FE(2)}	40	-	-	
Collector-Emitter saturation voltage	I _C = 800mA , I _B = 80mA	V _{CE(sat)}	-	-	0.5	V
Base-Emitter saturation voltage	I _C = 800mA , I _B = 80mA	V _{BE(sat)}	-	-	1.2	V
Transition frequency	V _{CE} = 10V , I _C = 50mA , f = 30MHz	f _T	100	-	-	MHz

Company reserves the right to improve product design , functions and reliability without notice.

REV: A

RATING AND CHARACTERISTIC CURVES (SS8050-G)

Fig.1 - Static Characteristic

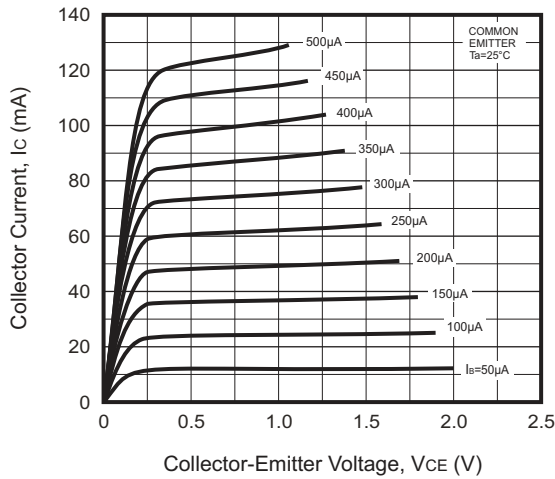

Fig.2 - $h_{FE} - I_c$

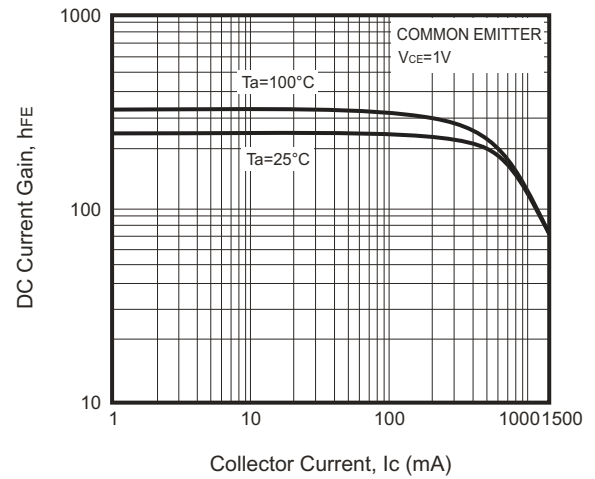

Fig.3 - $V_{CEsat} - I_c$

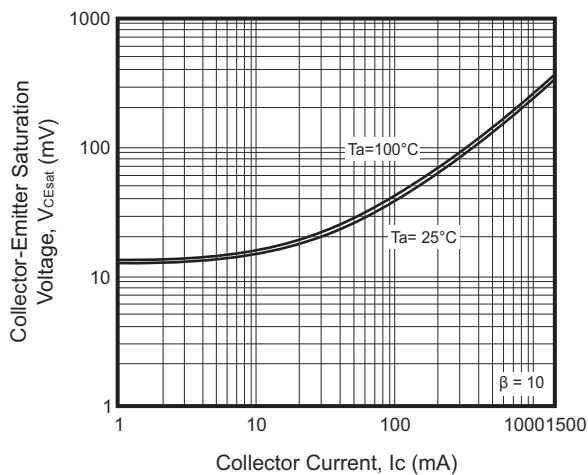

Fig.4 - $V_{BEsat} - I_c$

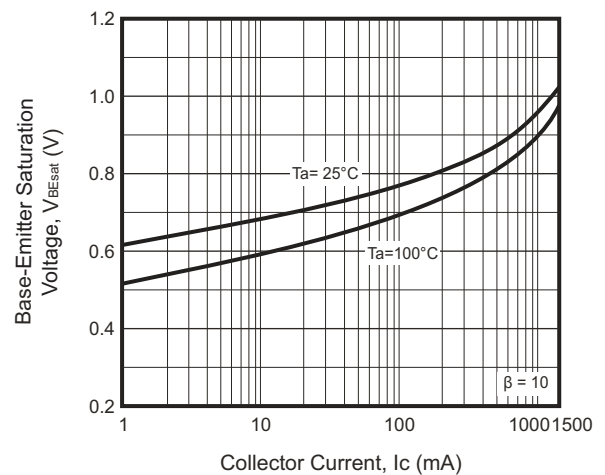

Fig.5 - $V_{BE} - I_c$

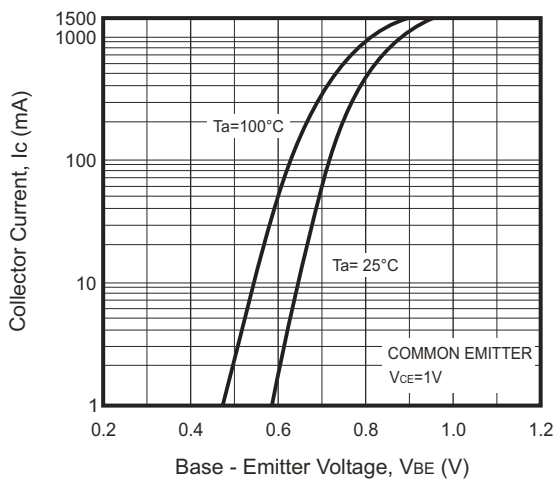
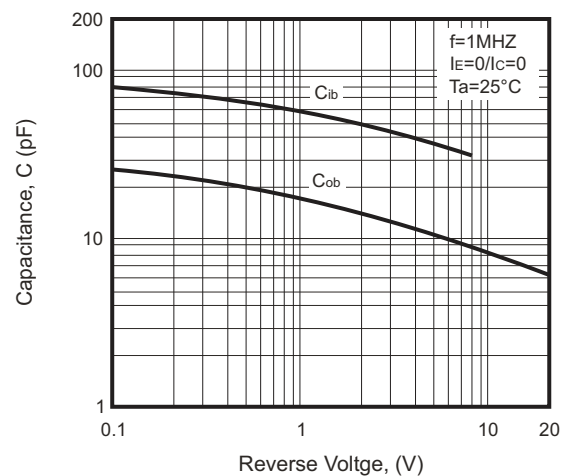

Fig.6 - $C_{ob}/C_{ib} - V_{CB}/V_{EB}$



Company reserves the right to improve product design, functions and reliability without notice.

REV: A

RATING AND CHARACTERISTIC CURVES (SS8050-G)

Fig.7 - F_T — I_c

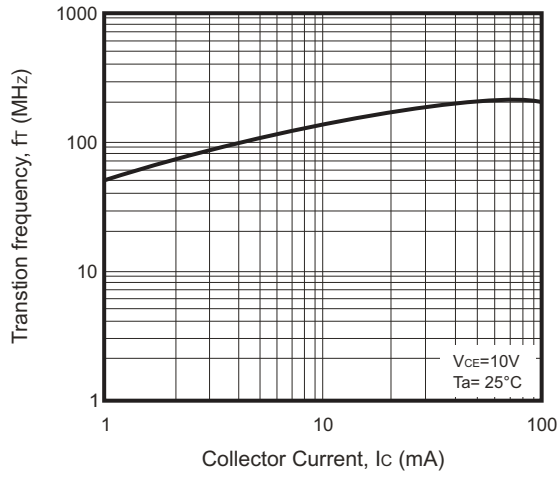
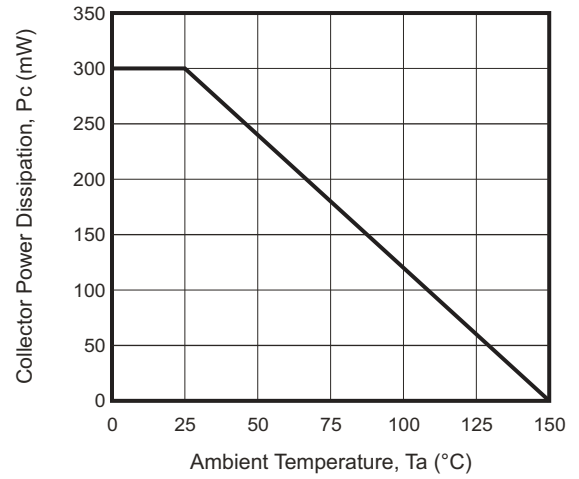
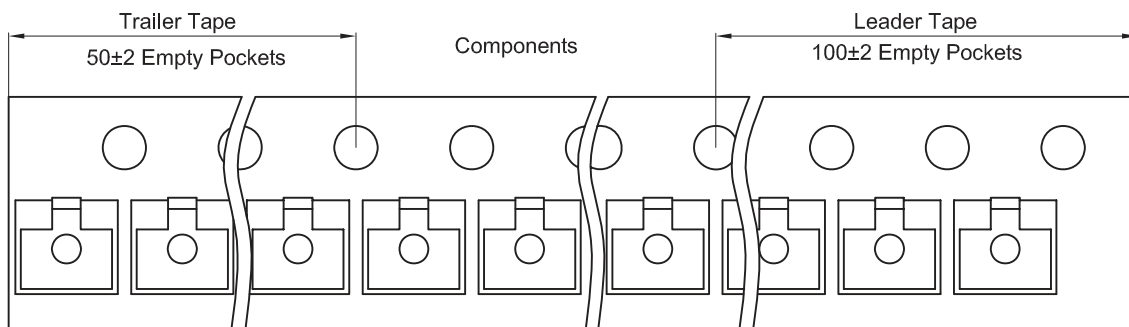
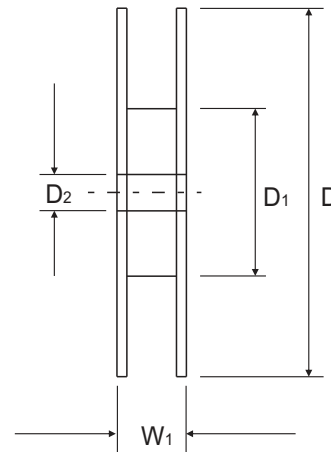
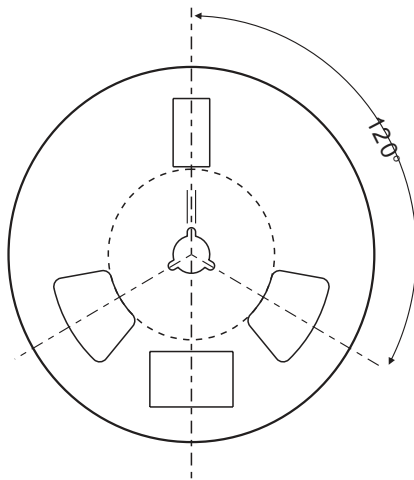
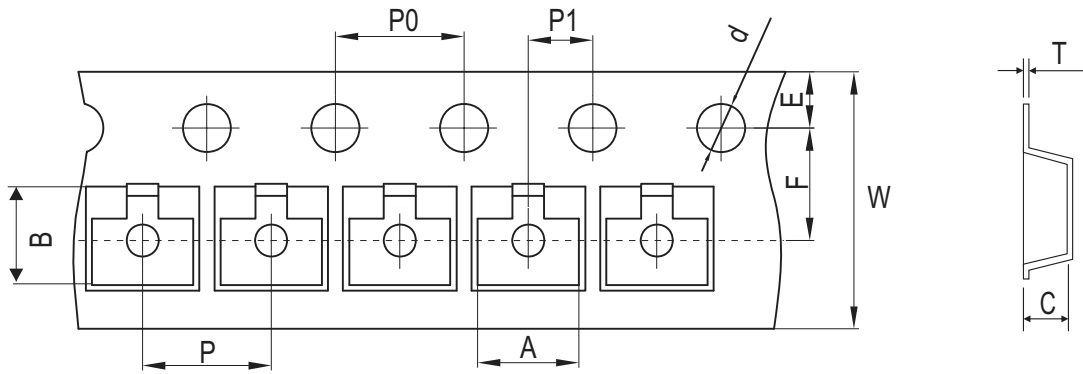

Fig.8 - P_c — T_a



Reel Taping Specification



SOT-23	SYMBOL	A	B	C	d	D	D1	D2
	(mm)	3.15 ± 0.10	2.77 ± 0.10	1.22 ± 0.10	1.50 ± 0.10	178.00 ± 2.00	54.40 ± 1.00	13.00 ± 1.00
	(inch)	0.124 ± 0.004	0.109 ± 0.004	0.048 ± 0.004	0.059 ± 0.004	7.087 ± 0.079	2.142 ± 0.039	0.512 ± 0.039

SOT-23	SYMBOL	E	F	P	P0	P1	W	W1
	(mm)	1.75 ± 0.10	3.50 ± 0.10	4.00 ± 0.10	4.00 ± 0.10	2.00 ± 0.10	8.00 + 0.30 / - 0.10	12.30 ± 1.00
	(inch)	0.069 ± 0.004	0.138 ± 0.004	0.157 ± 0.004	0.157 ± 0.004	0.079 ± 0.004	0.315 + 0.012 / - 0.004	0.484 ± 0.039

Company reserves the right to improve product design, functions and reliability without notice.

REV: A

Marking Code

Part Number	Marking Code
SS8050-G	Y1

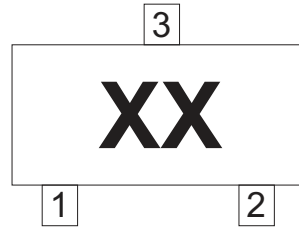

xx = Product type marking code

Suggested PAD Layout

SIZE	SOT-23	
	(mm)	(inch)
A	0.80	0.031
B	0.60	0.024
C	1.90	0.075
D	2.02	0.080

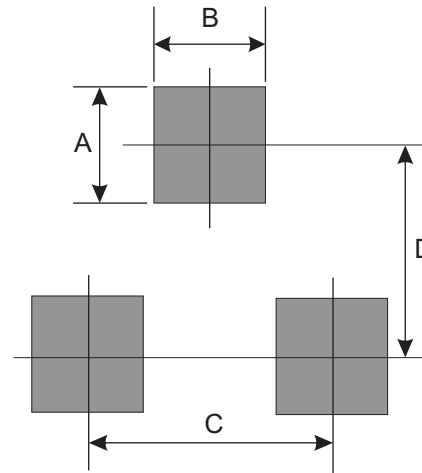

Note:

1. General tolerance: $\pm 0.05\text{mm}$.
2. The pad layout is for reference purposes only.

Standard Packaging

Case Type	REEL PACK	
	REEL (pcs)	Reel Size (inch)
SOT-23	3,000	7